

Blank space for 787-9 and 10 variants

Instructions



Scan

A14

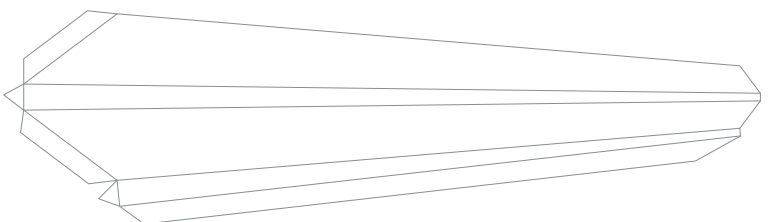

A16L

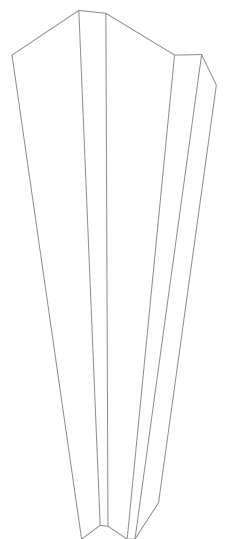

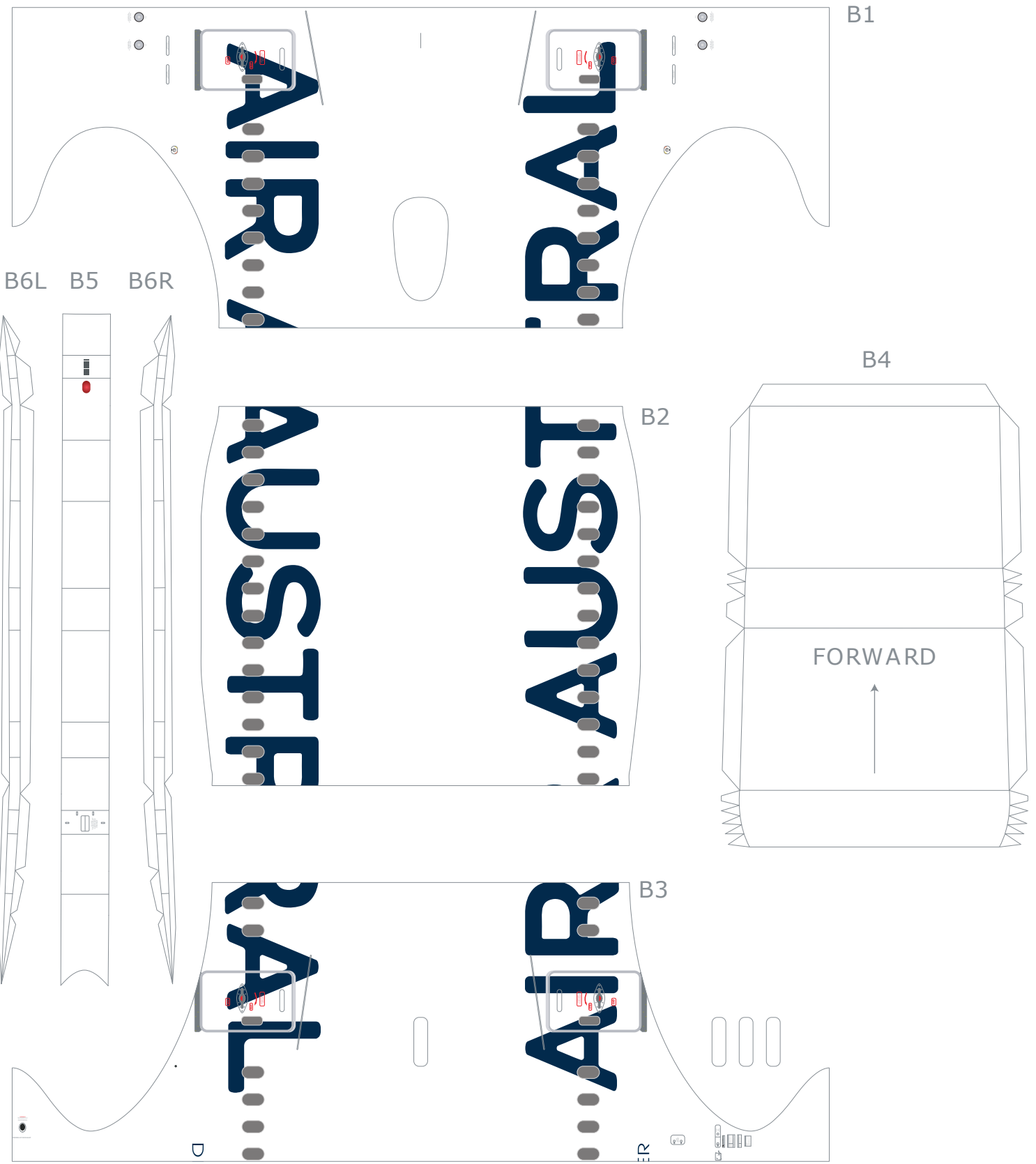

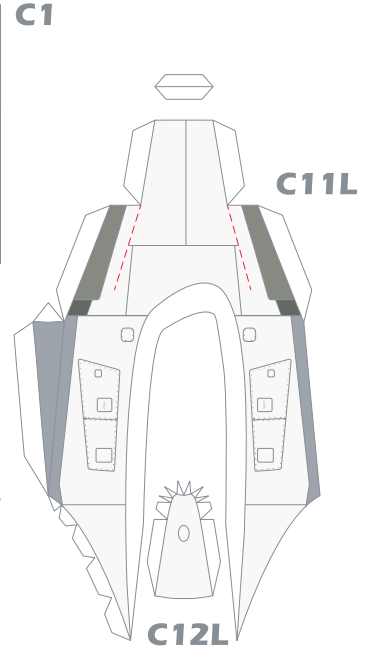

Blank space for 787-9 and 10 variants

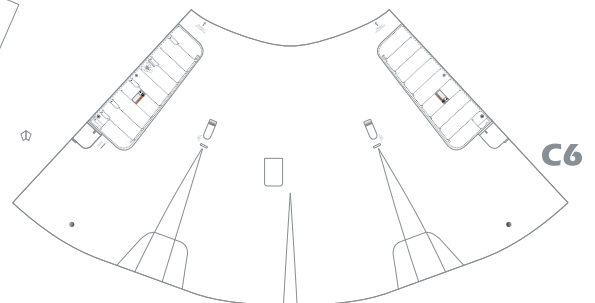
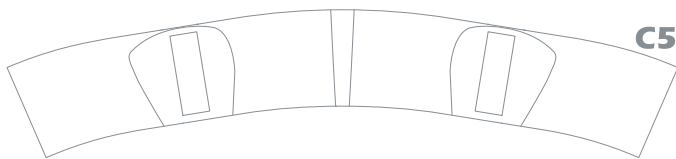
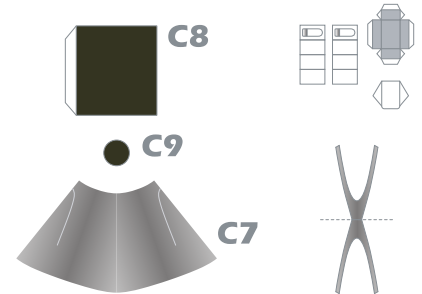
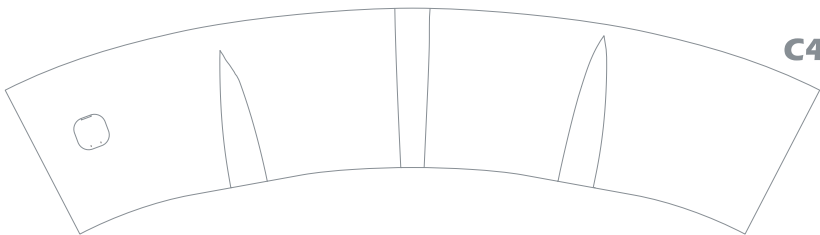
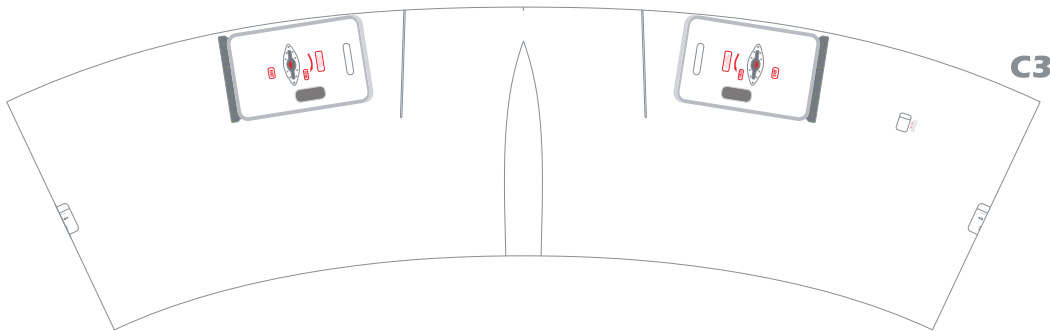
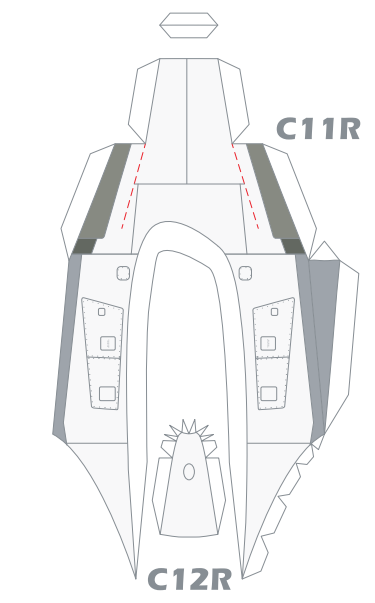
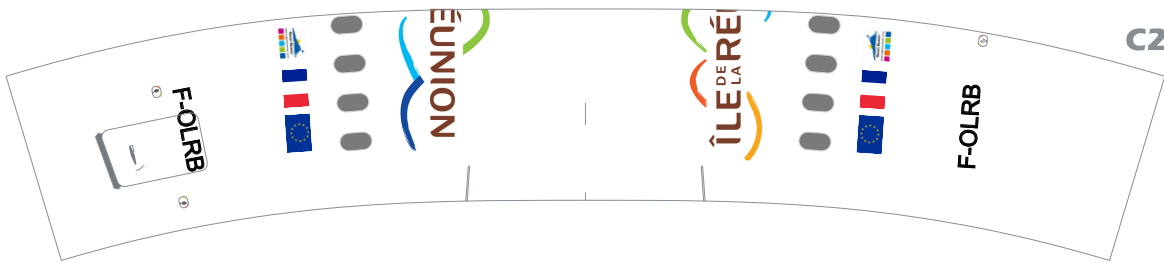

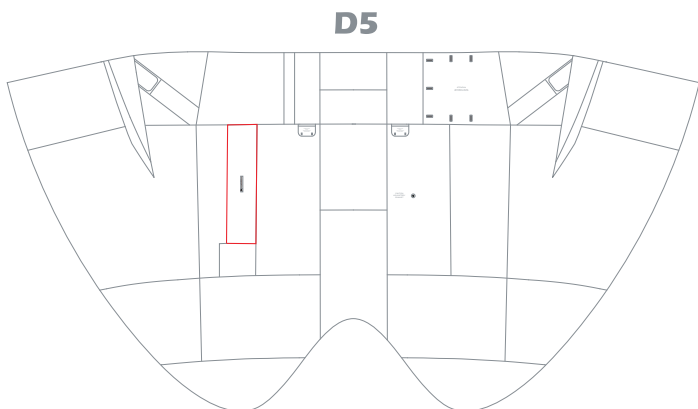
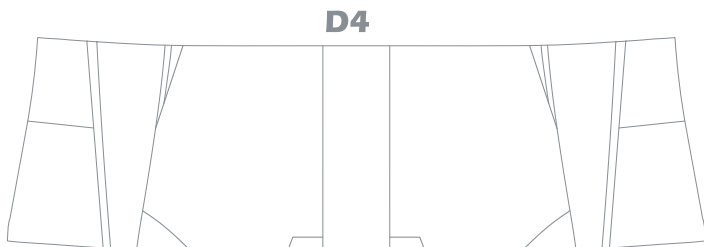
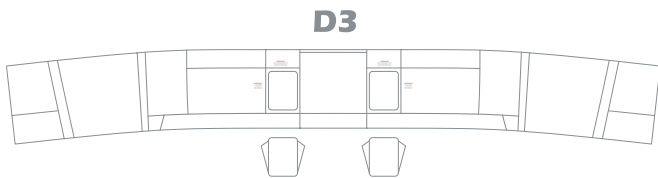
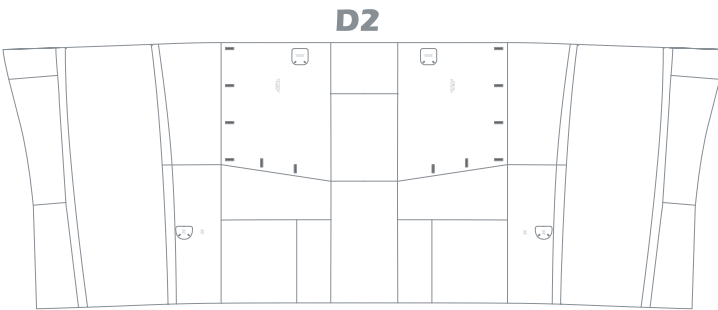
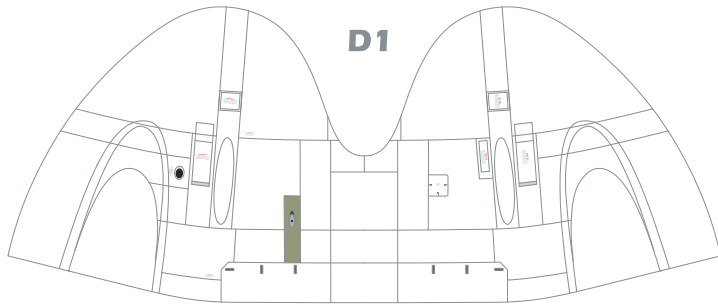

D7



D8

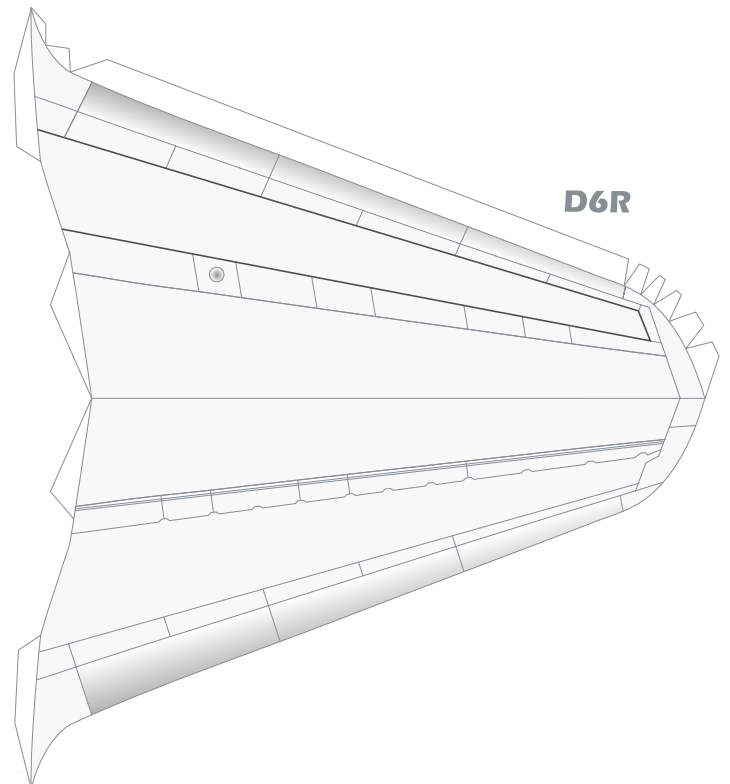
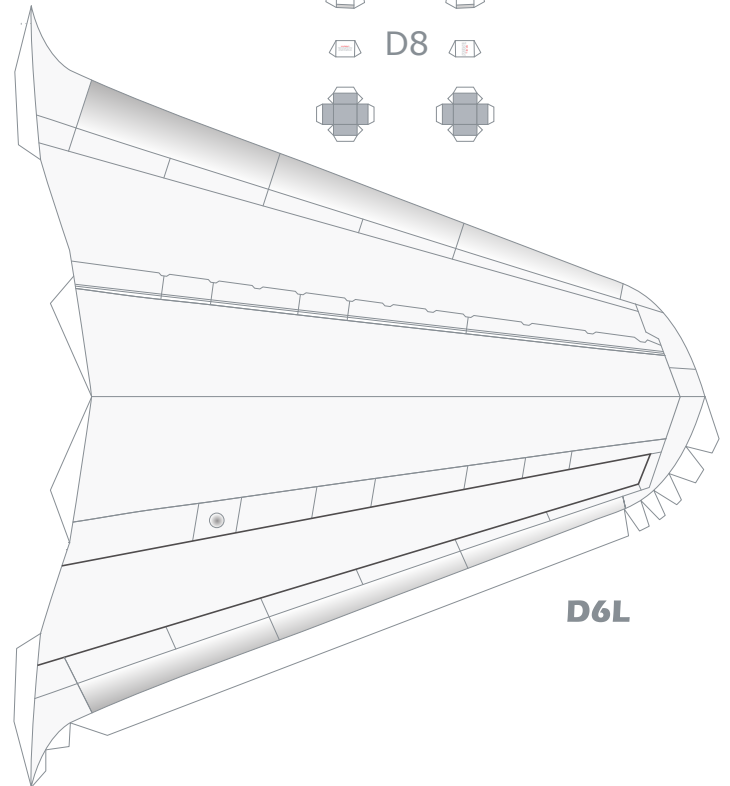

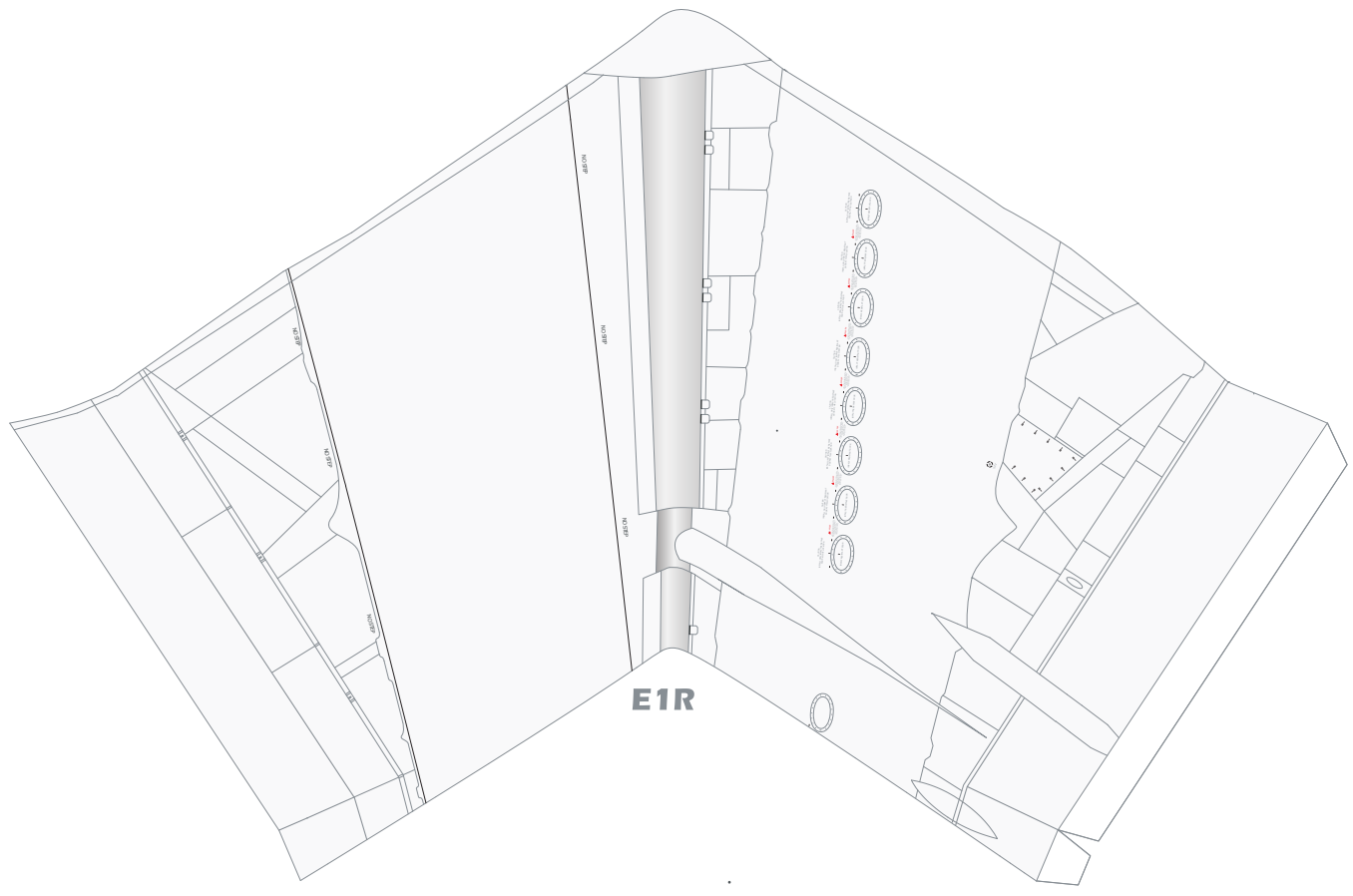
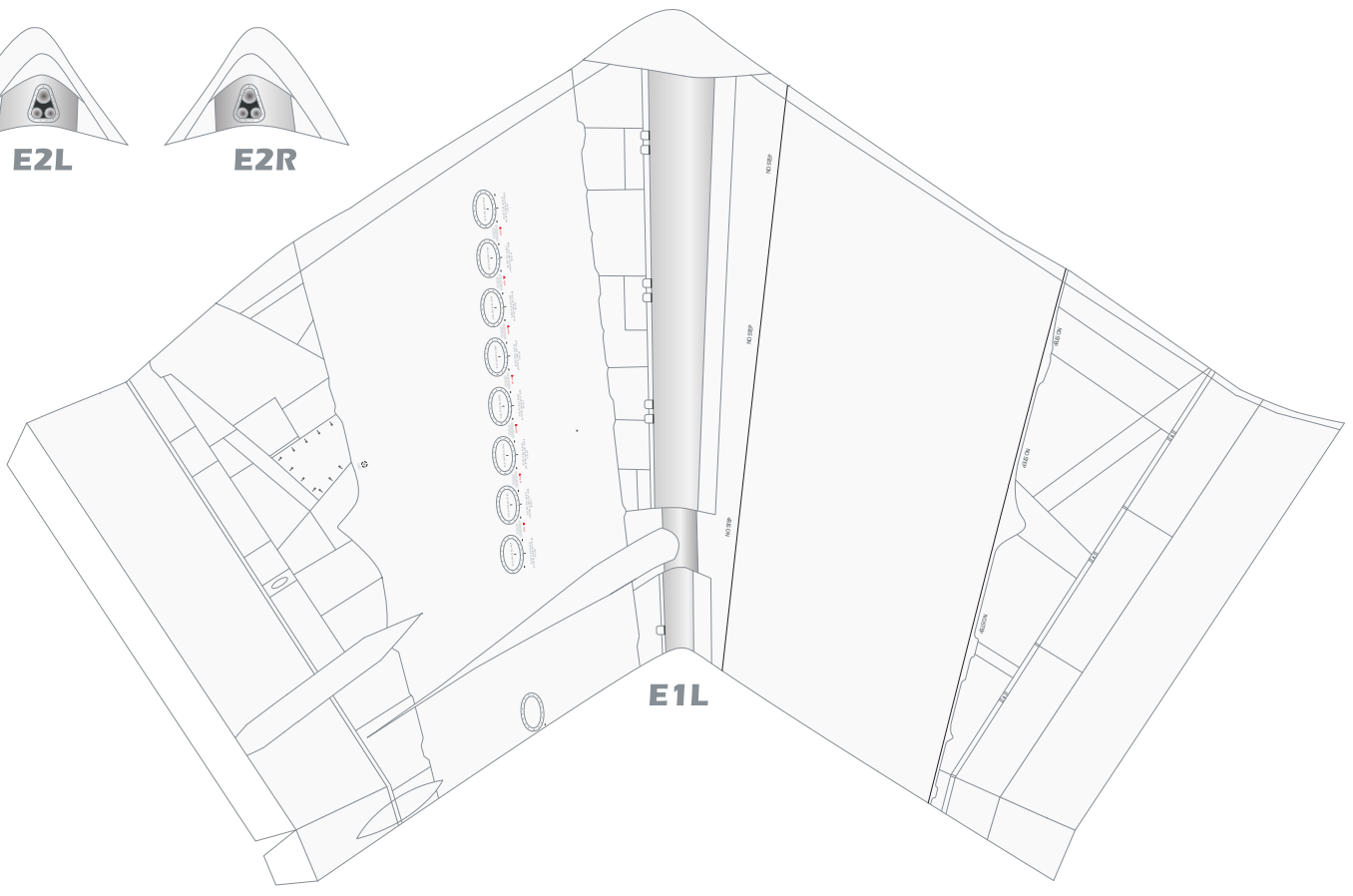

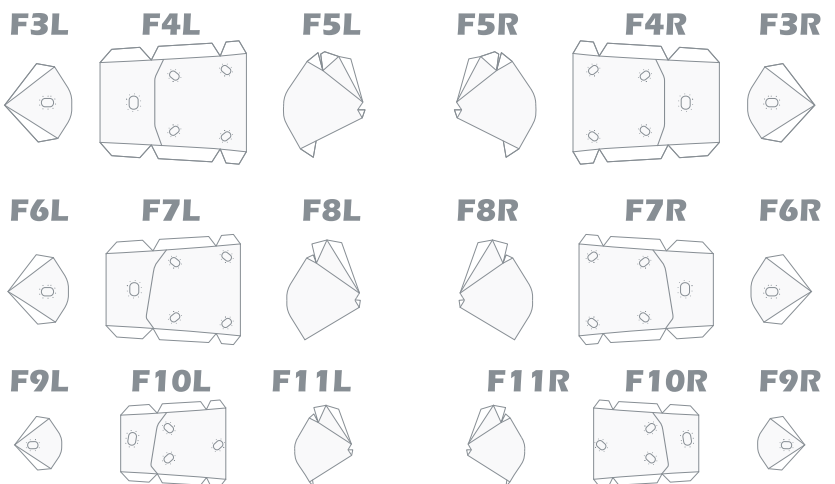
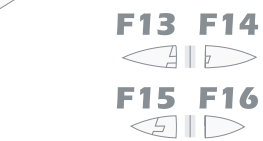
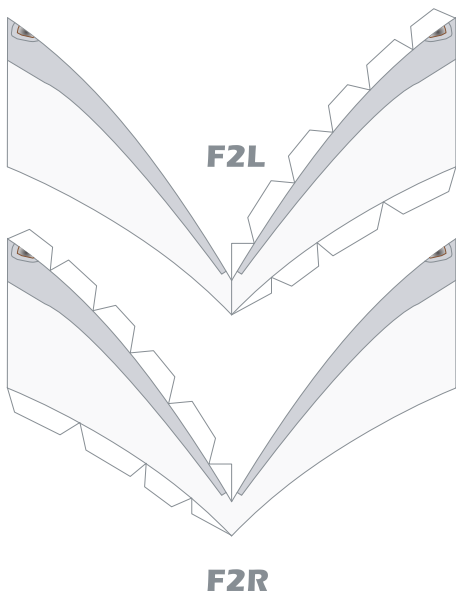
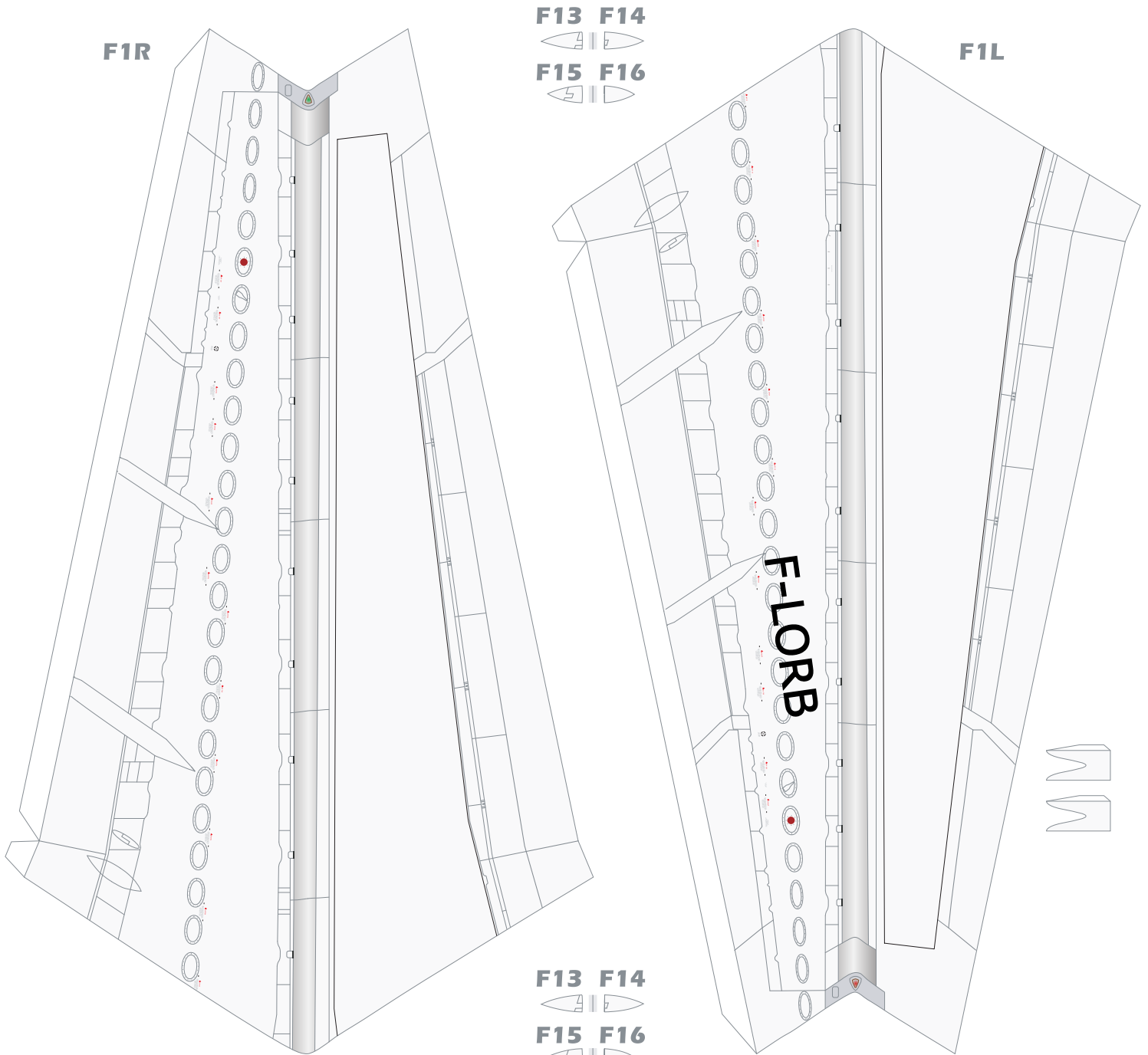

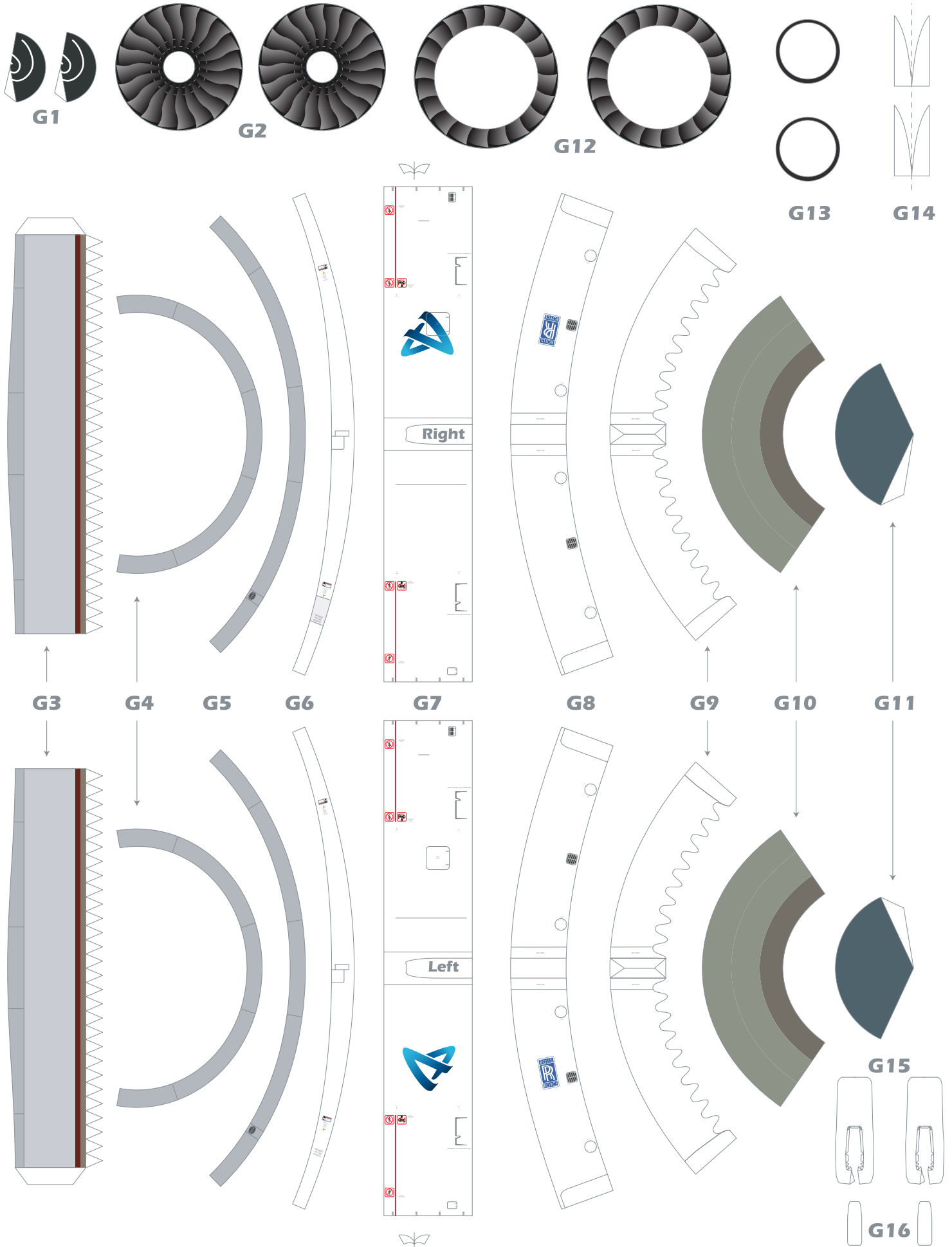

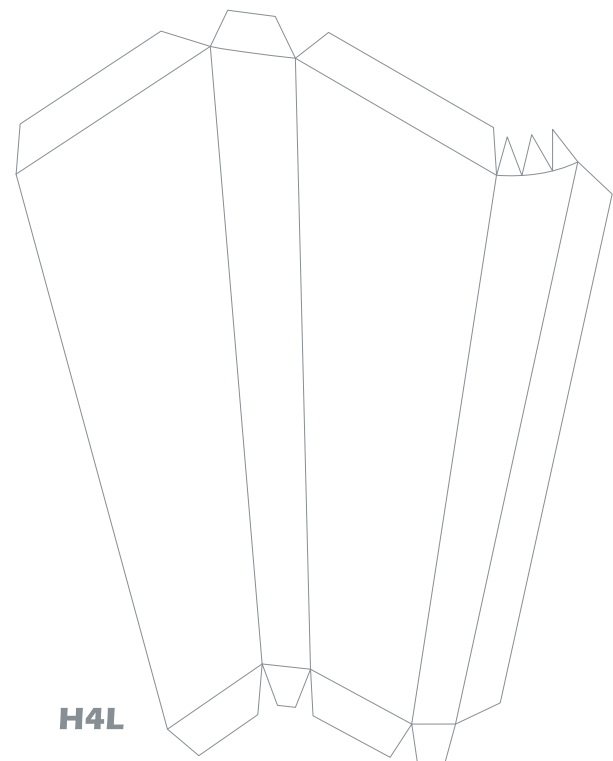
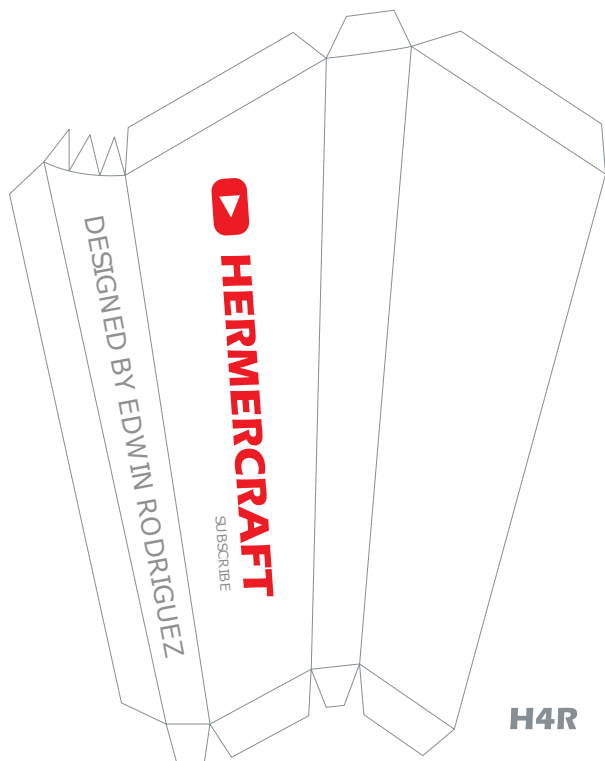
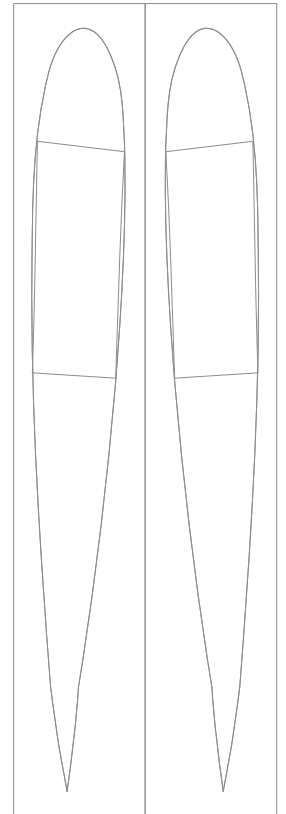
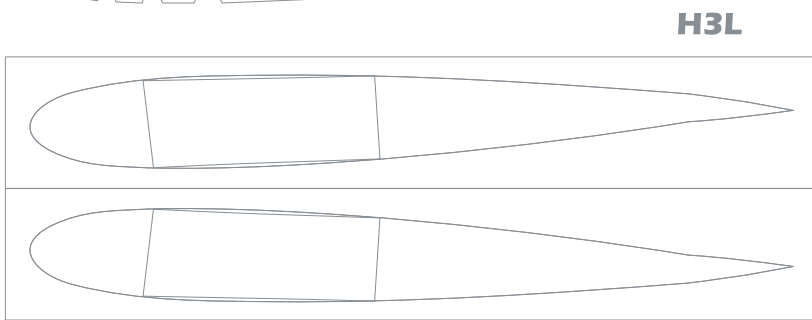
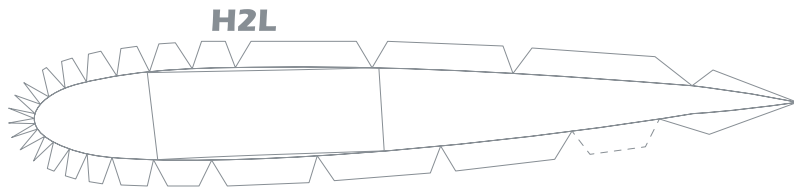
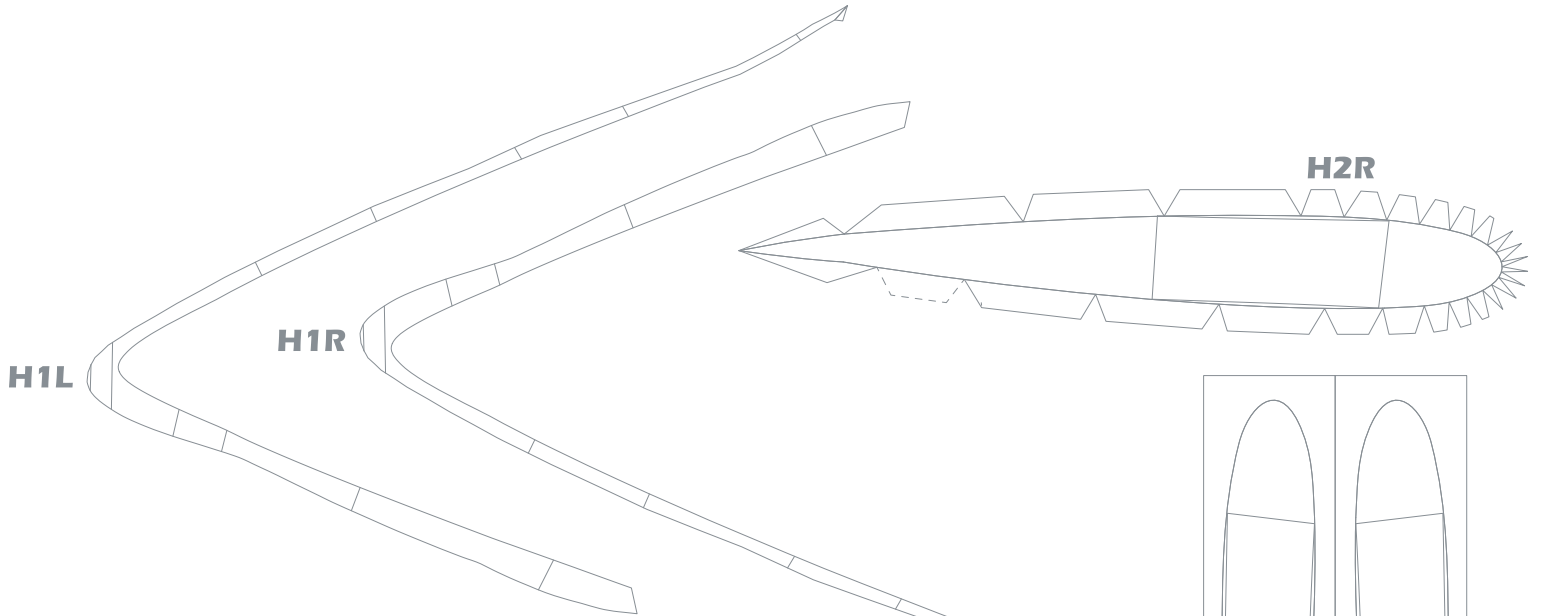

H4R

H4L

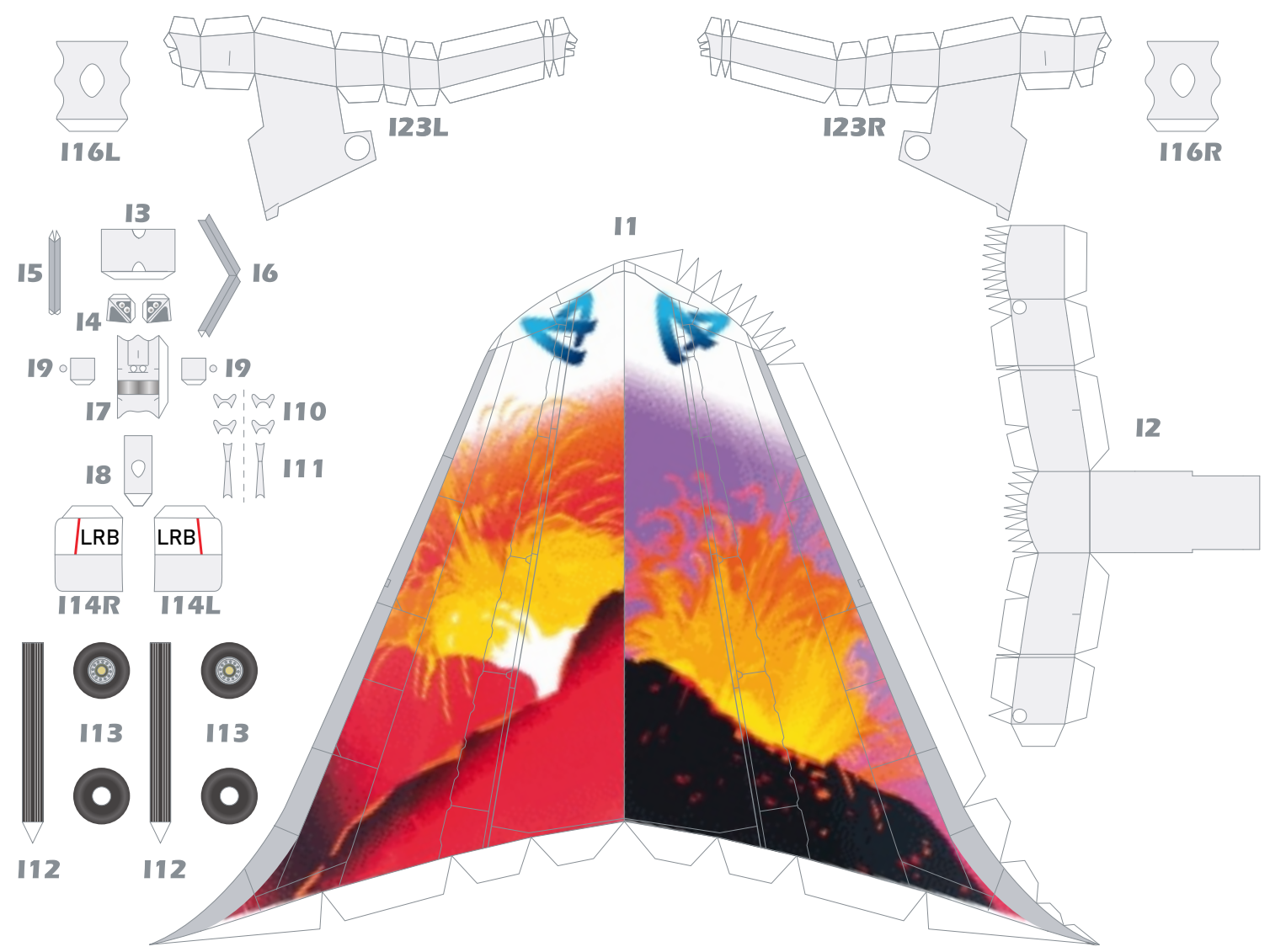
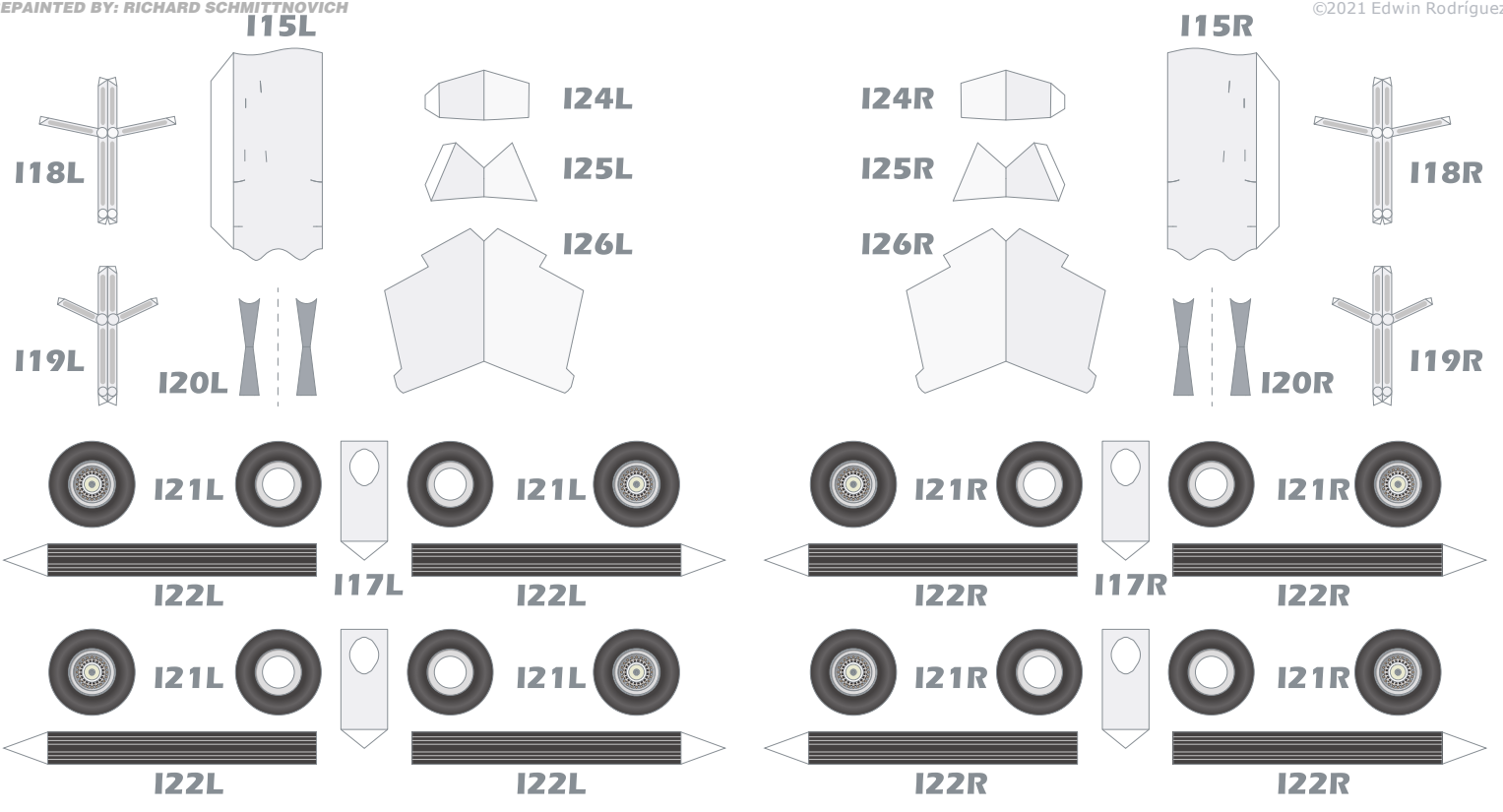

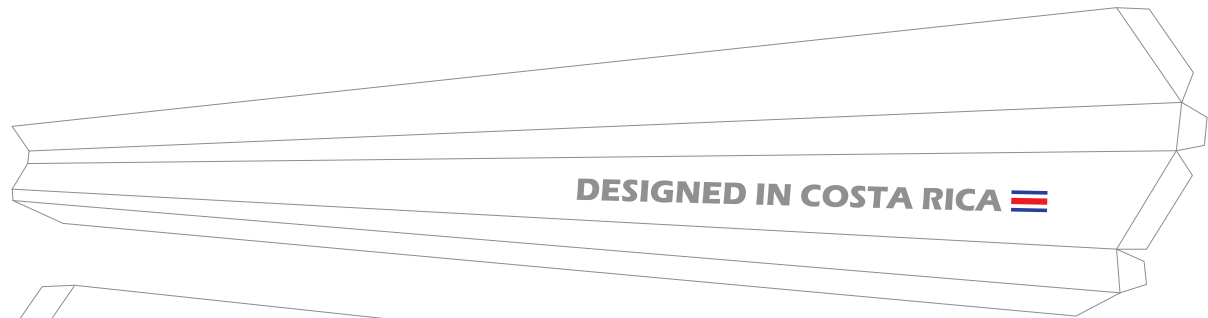

J1L



J1R

