

B4

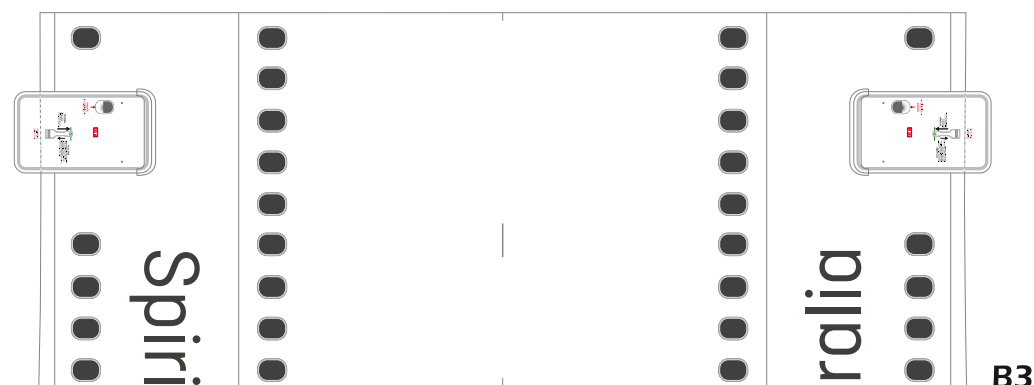

B3

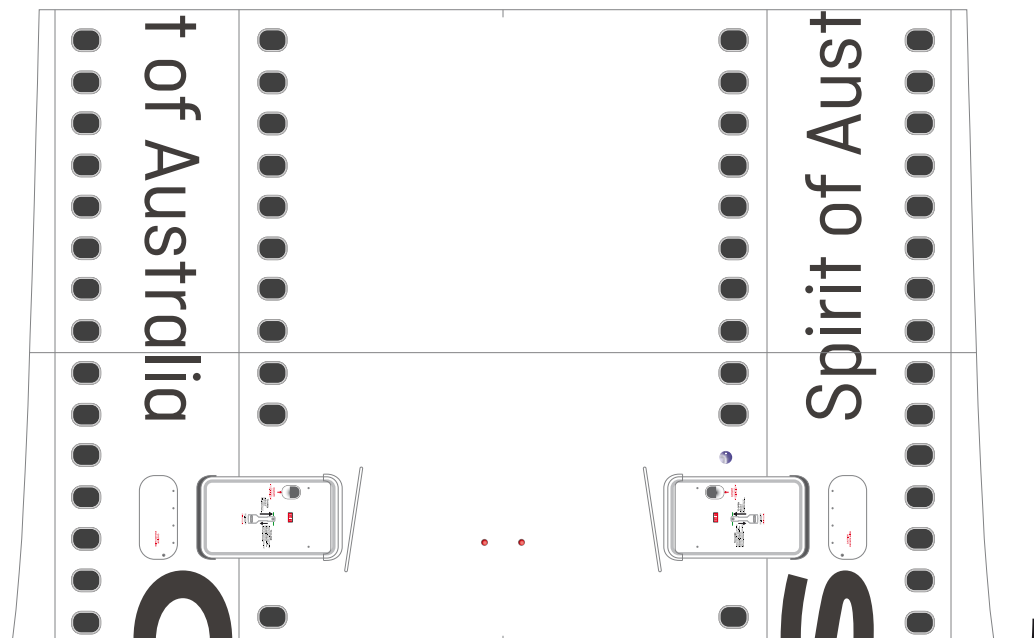

B2

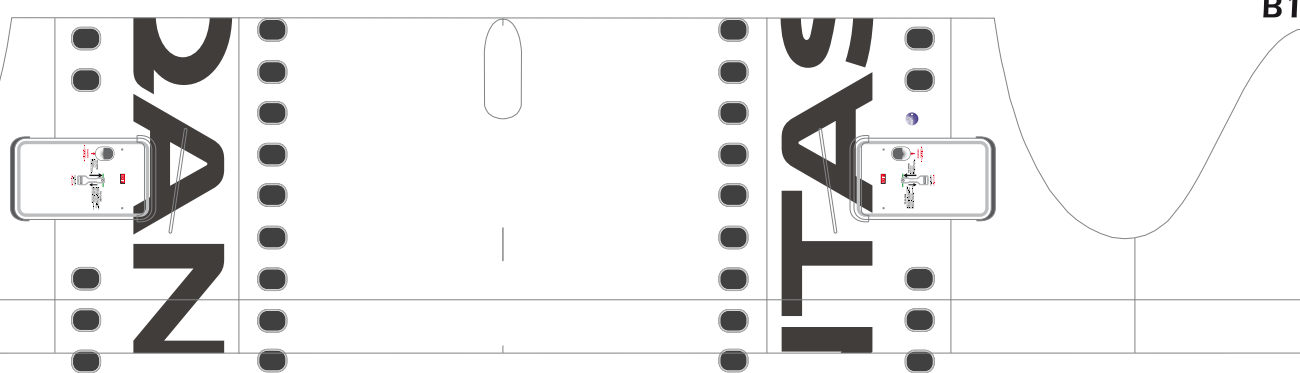

B1

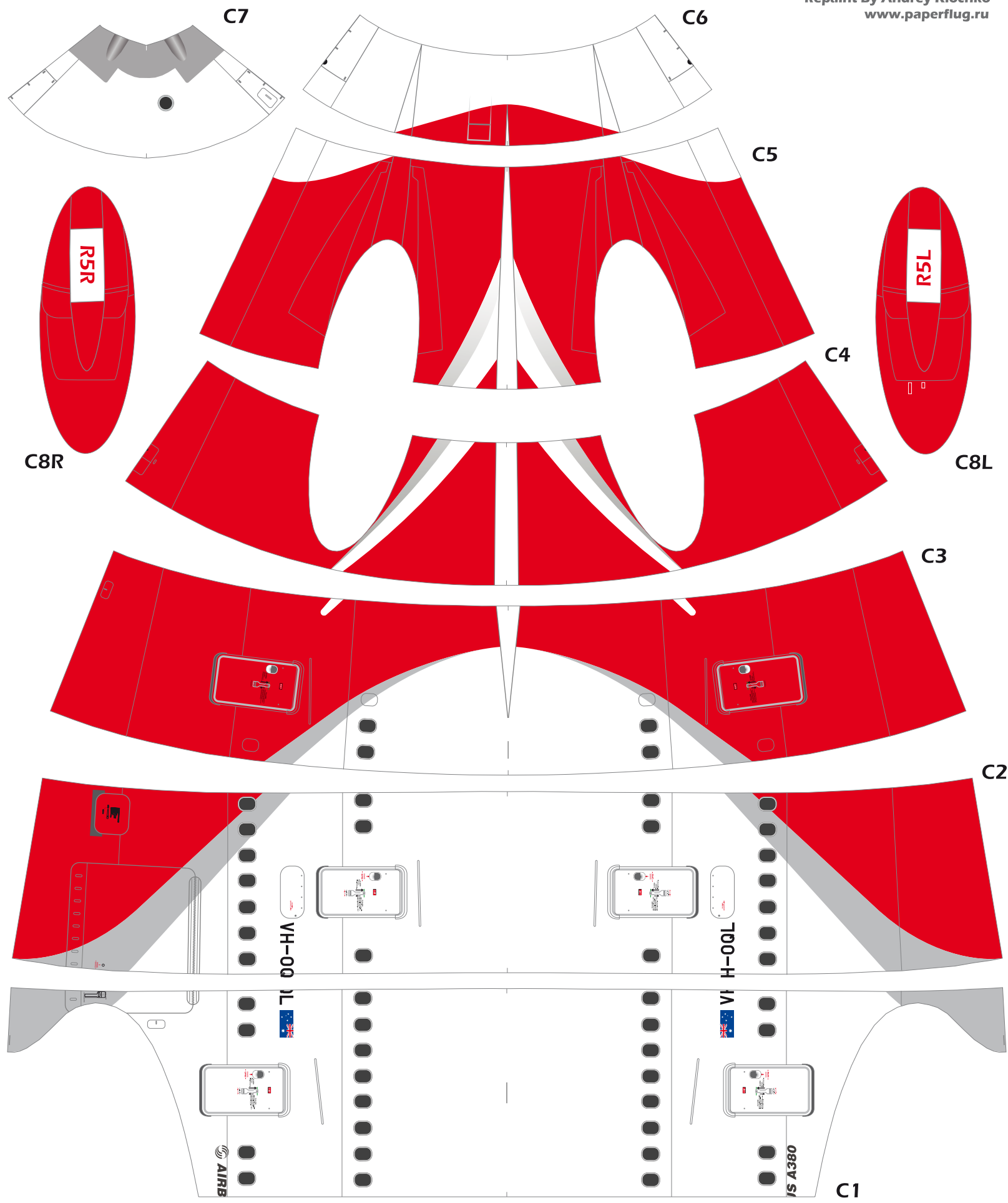

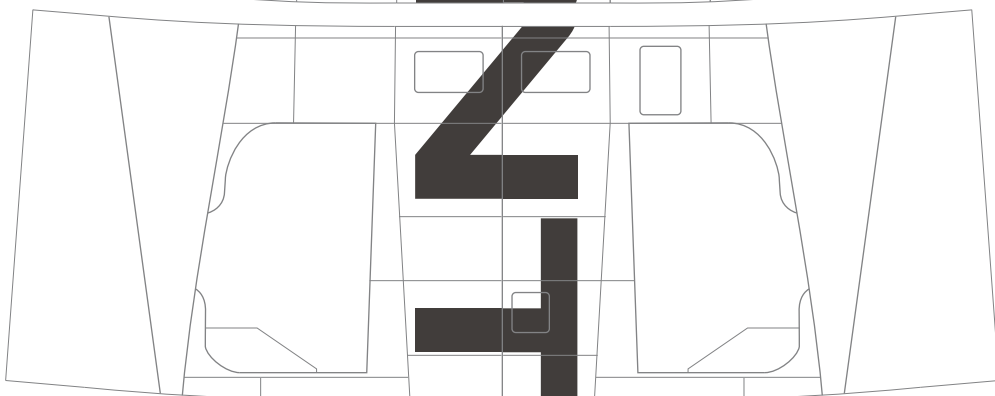
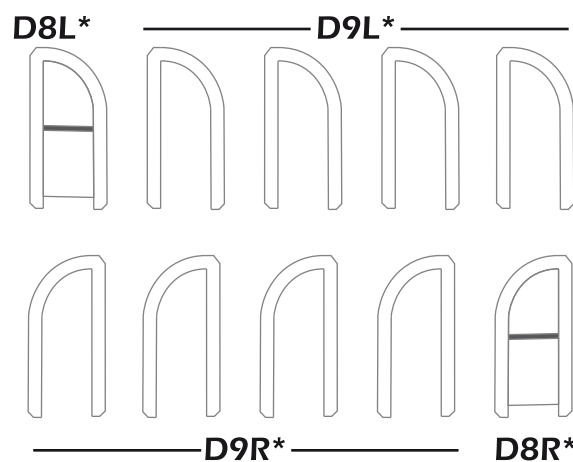
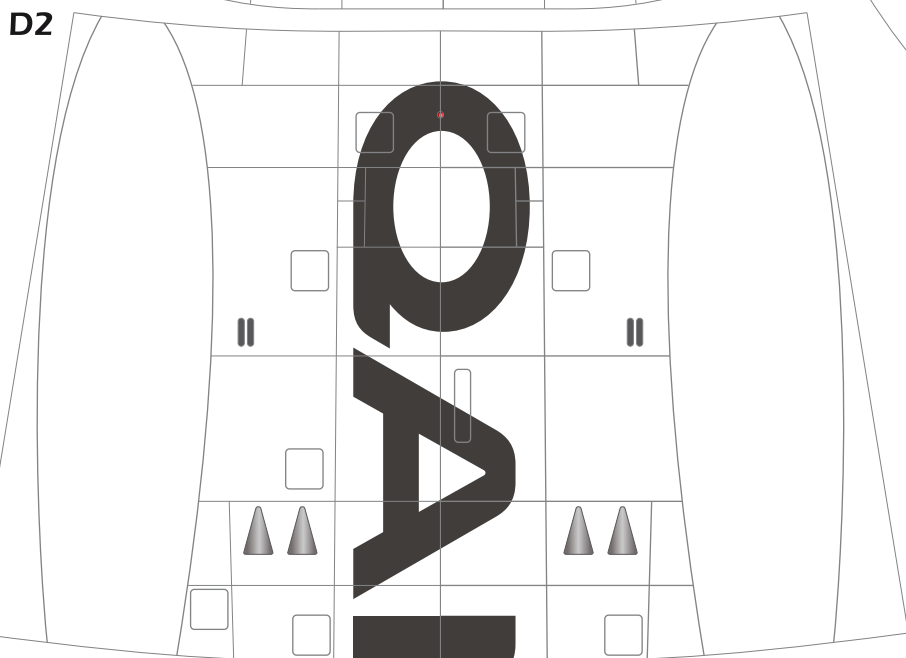
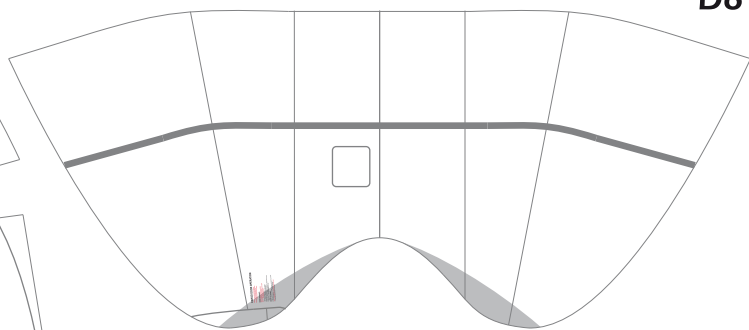
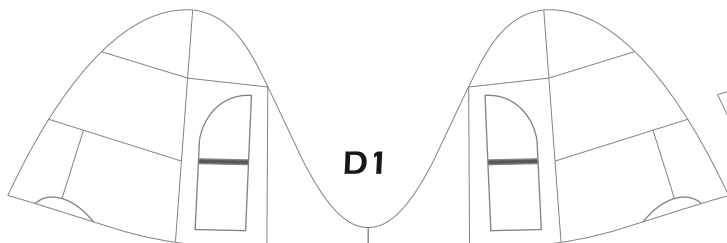

D3

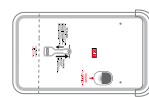

B3+D3 left door

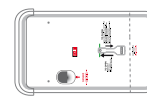

B3+D3 right door

D7R*

D7L*

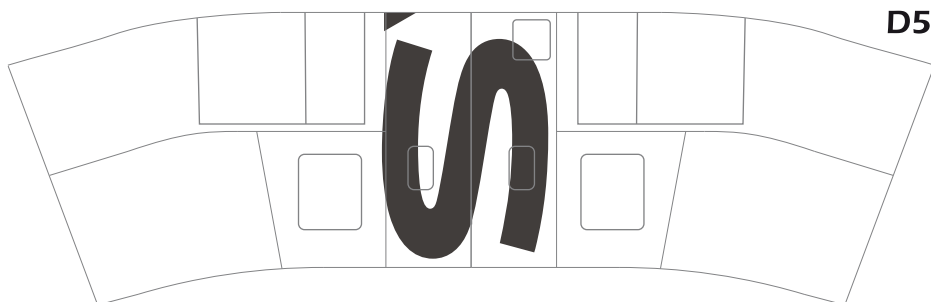
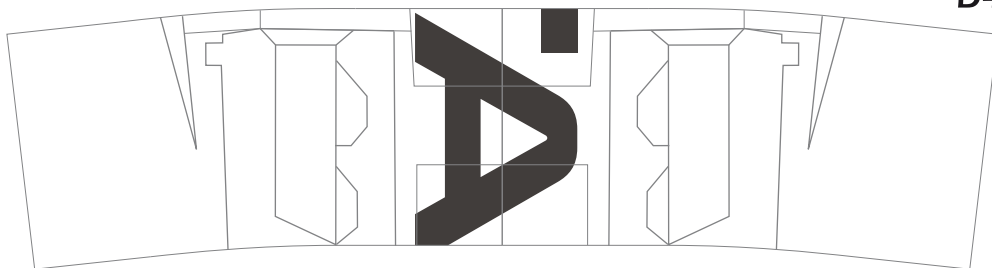
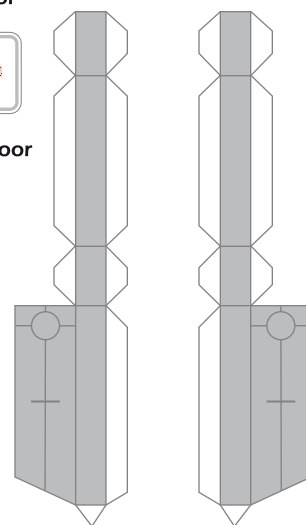

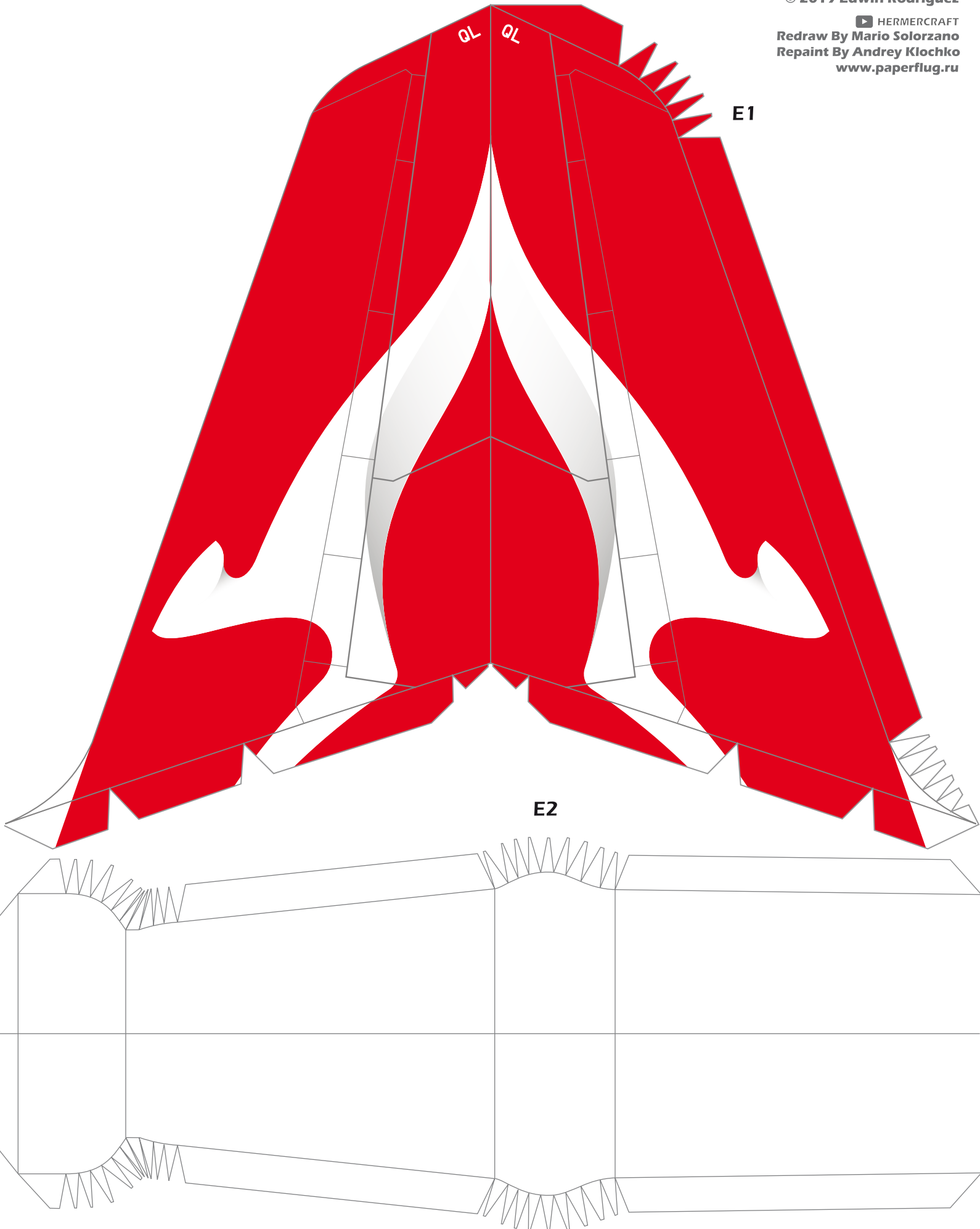

F1L

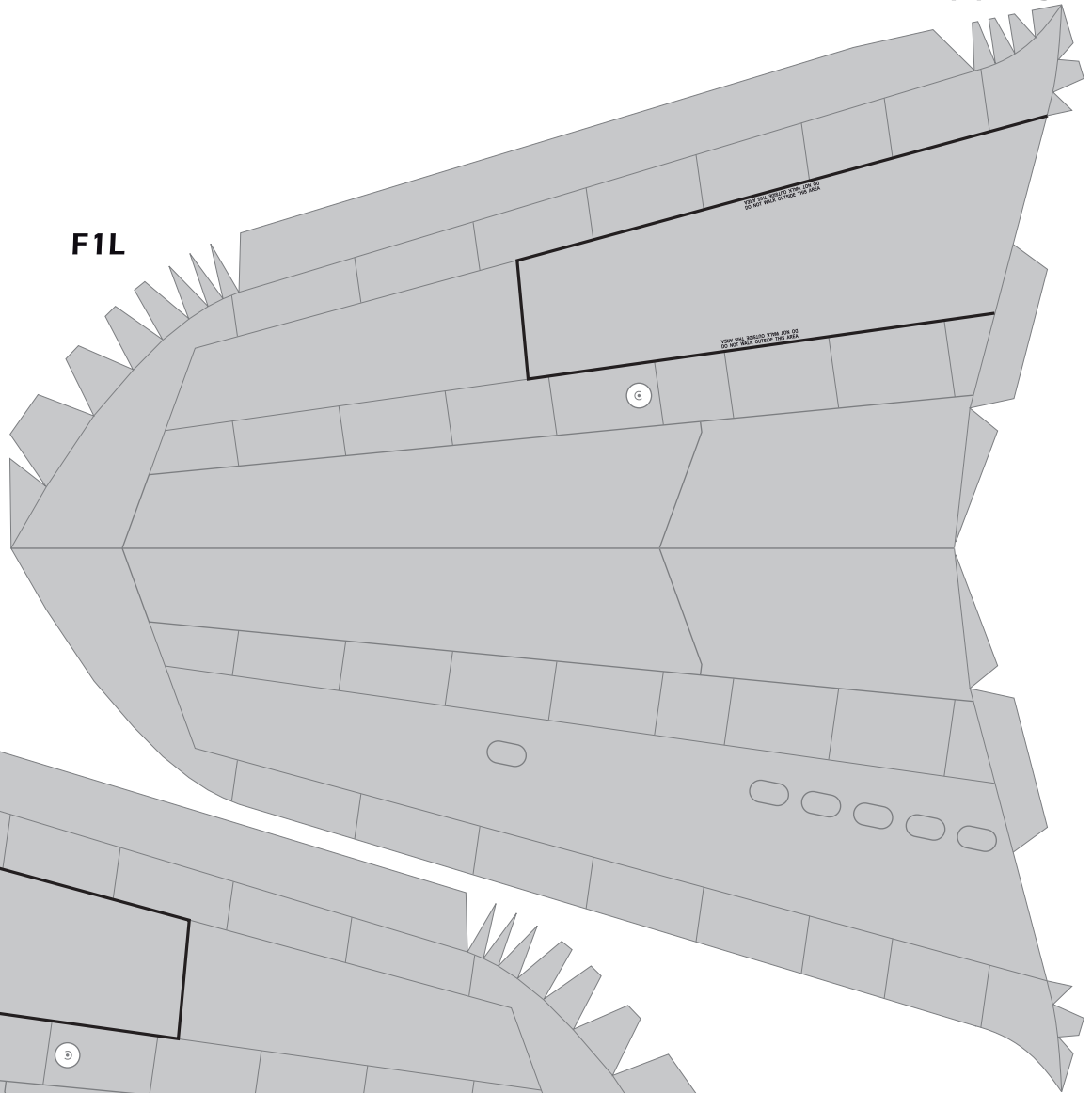

F1R

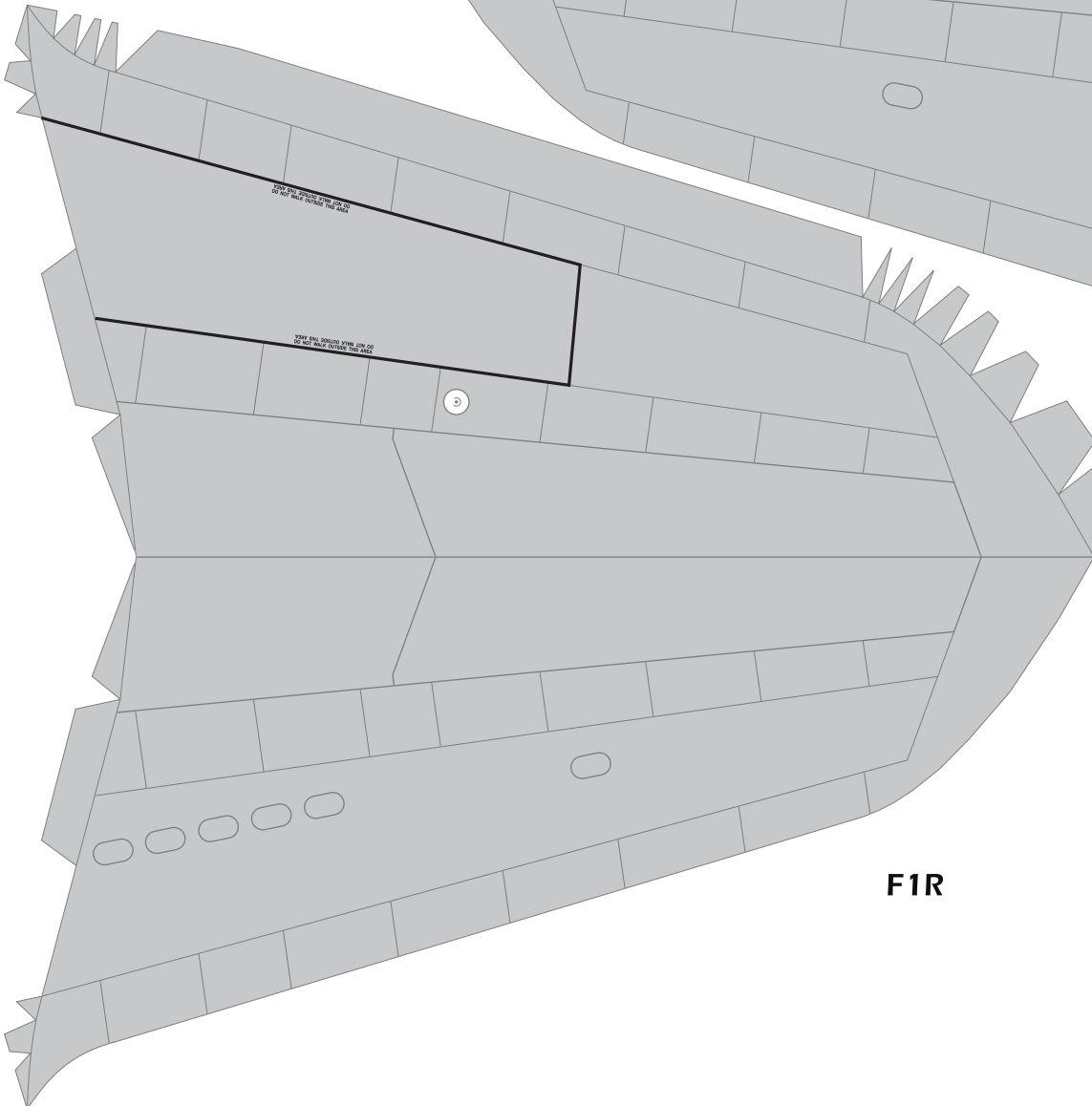

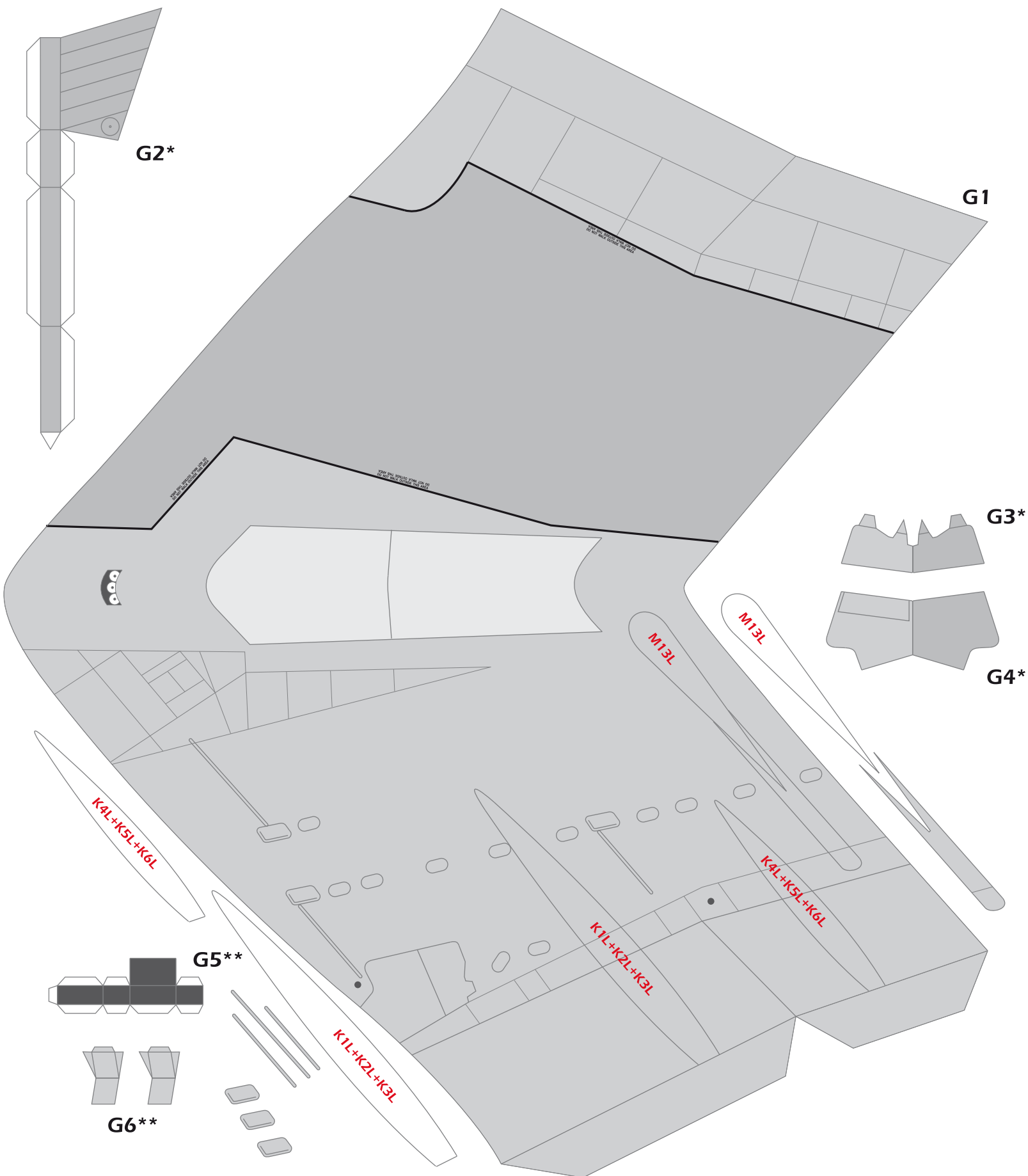

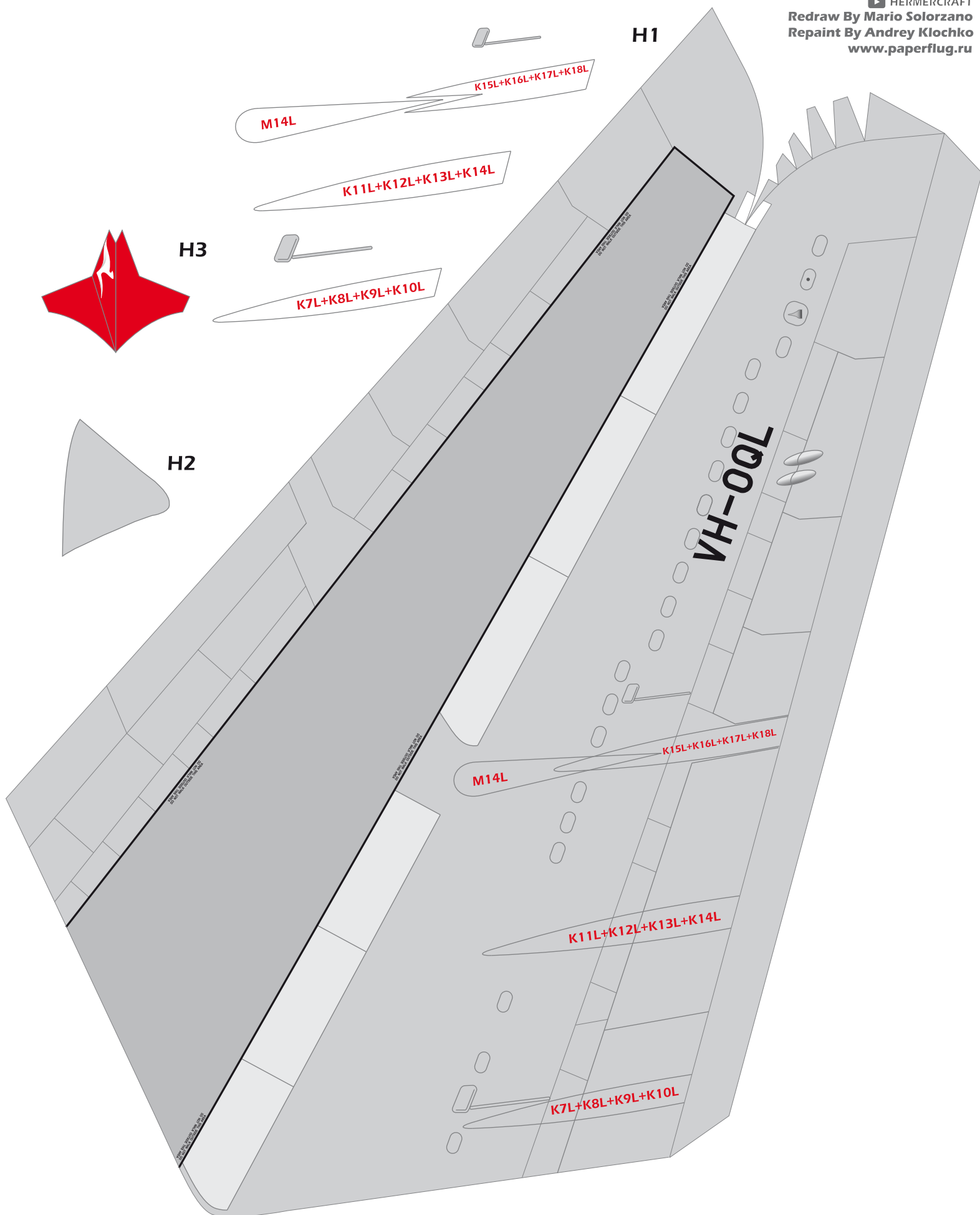

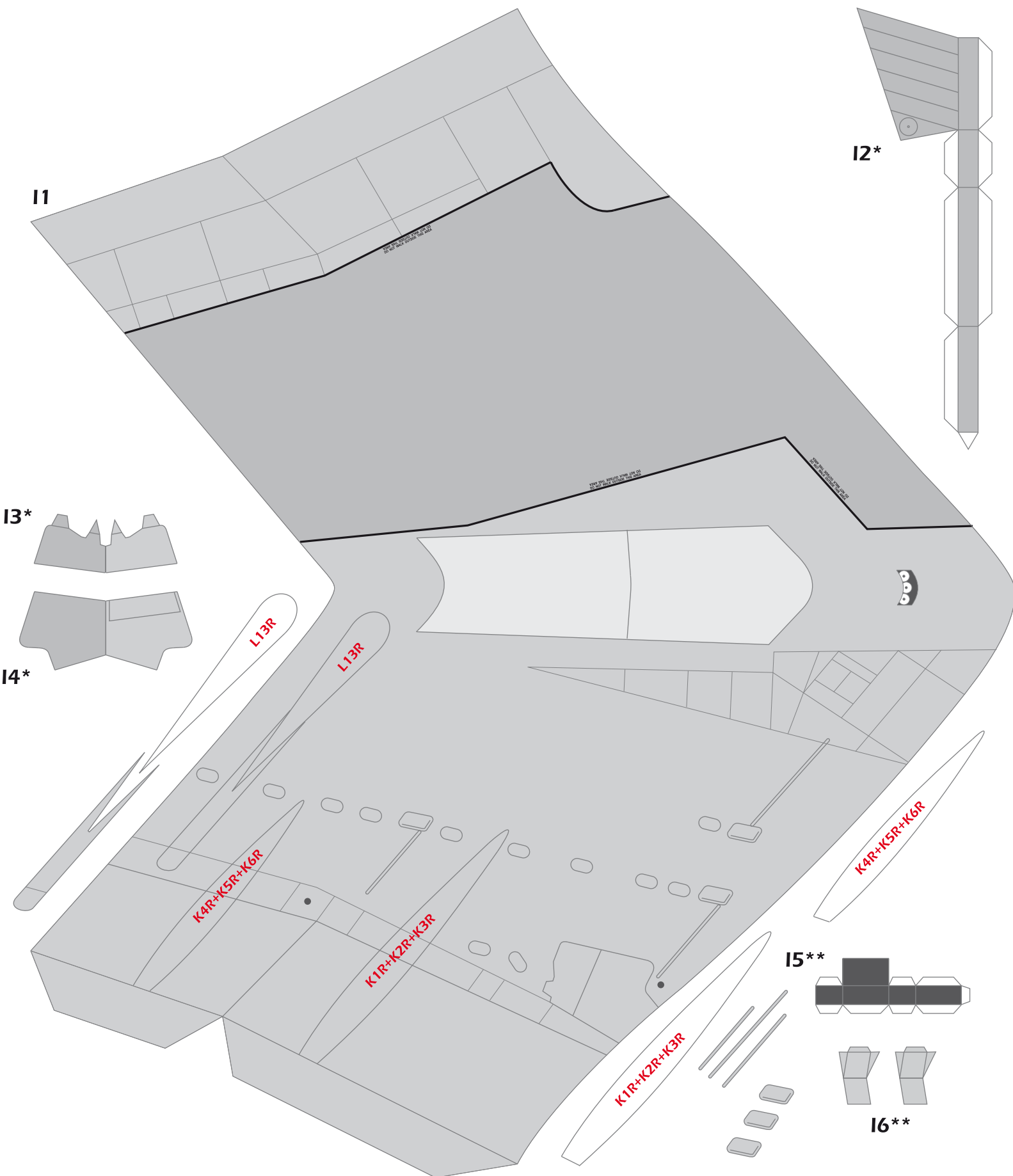

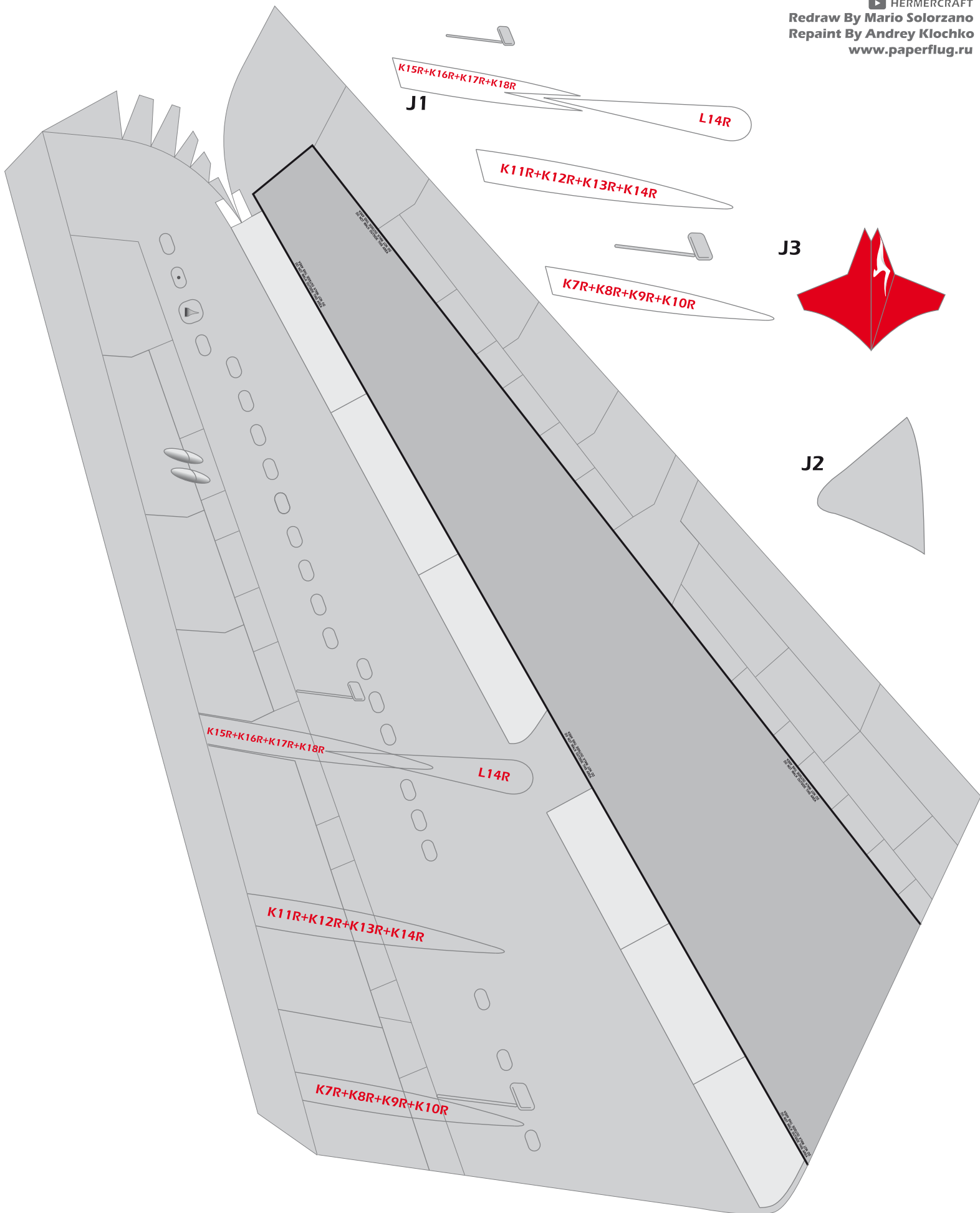

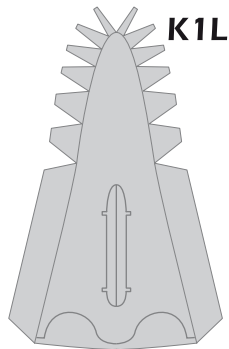

K1L

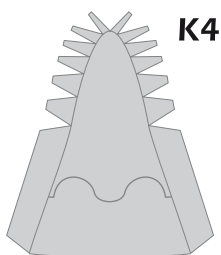

K4L

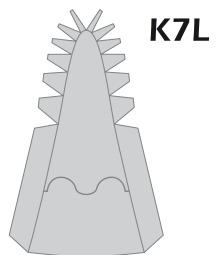

K7L

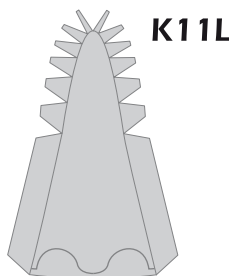

K11L

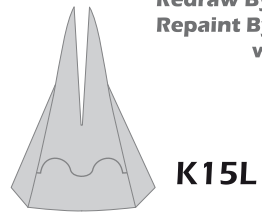

K15L

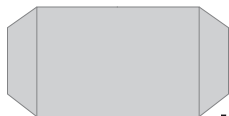

K5L

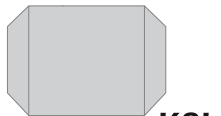

K8L



K12L



K16L



K2L

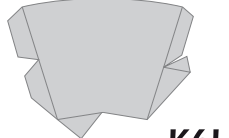

K6L

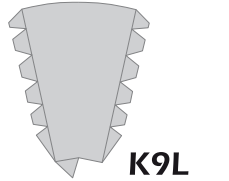

K9L

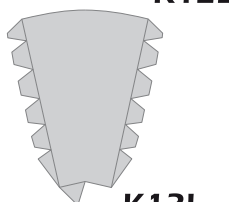

K13L

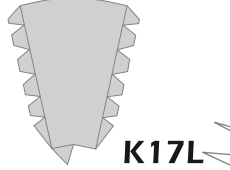

K17L

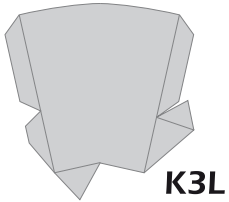

K3L

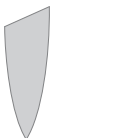

K10L



K14L

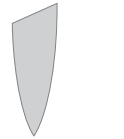

K18L

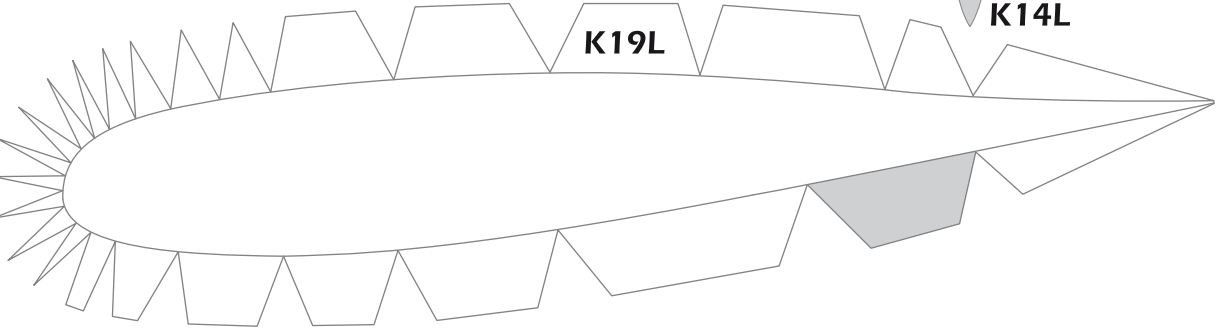

K19L

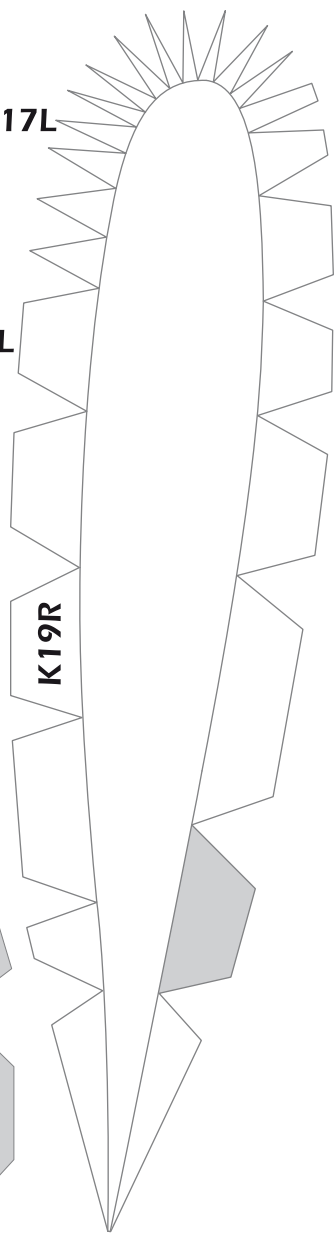

K19R

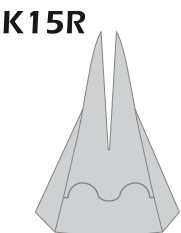

K15R

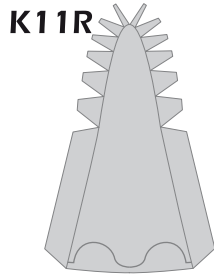

K11R

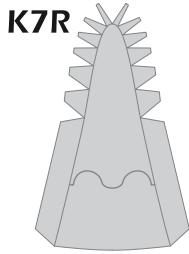

K7R

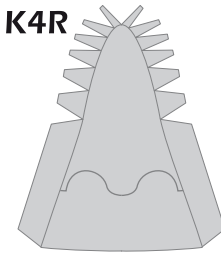

K4R

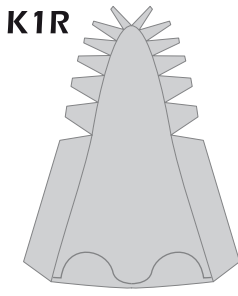

K1R



K16R



K8R



K5R

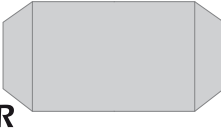

K2R

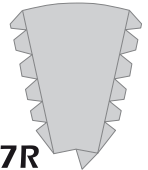

K17R

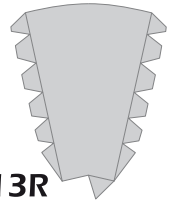

K12R

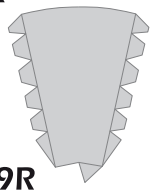

K9R

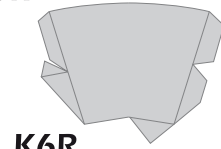

K6R



K3R



K18R

K13R



K14R



K10R

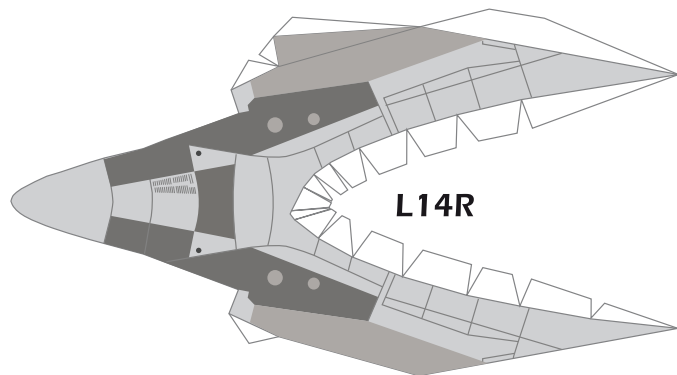
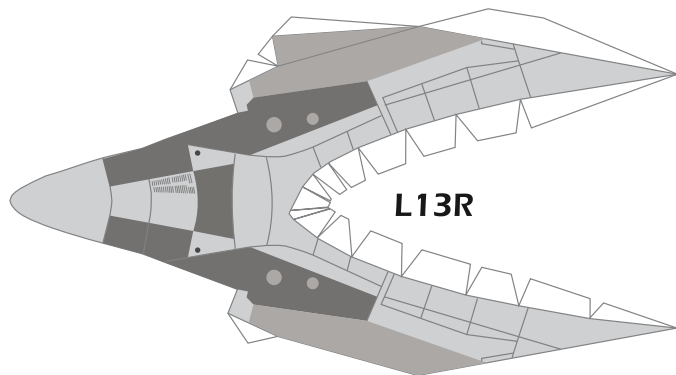
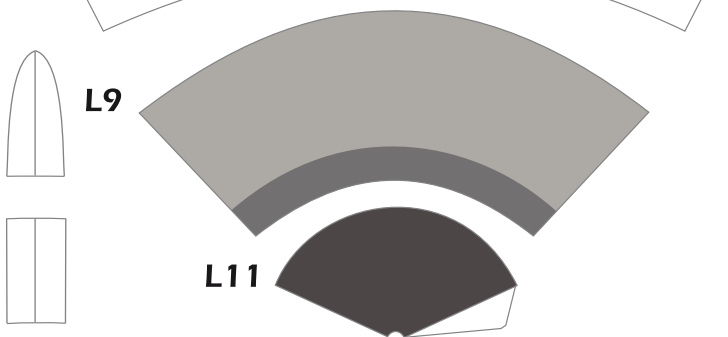
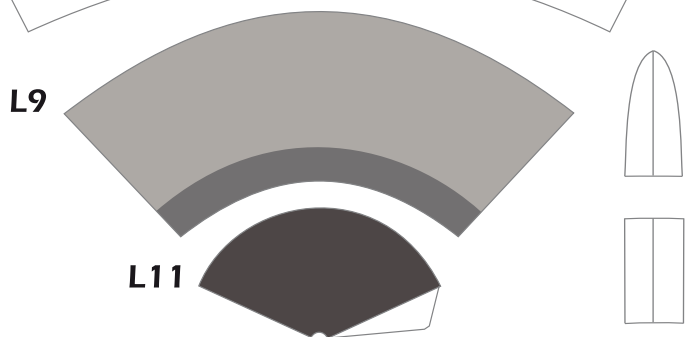
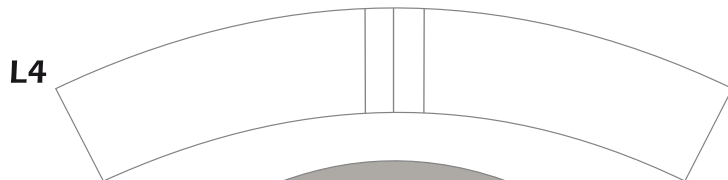
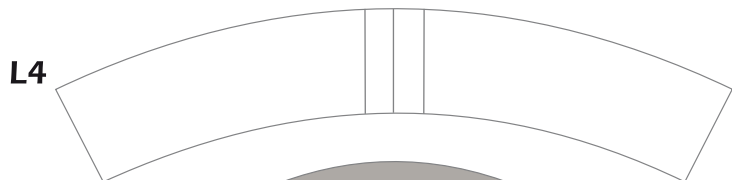
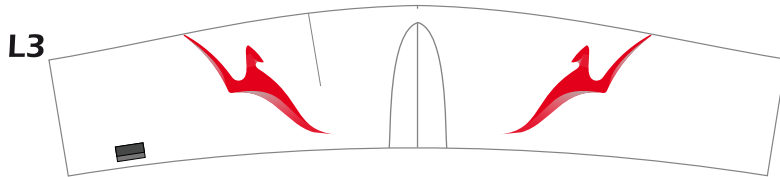
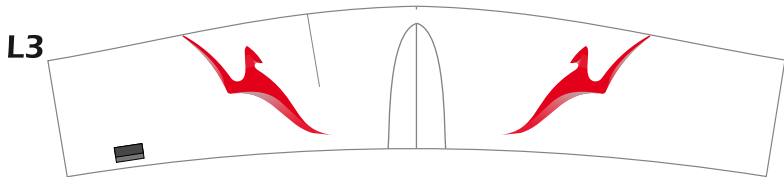
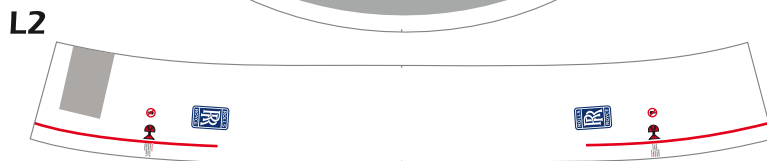
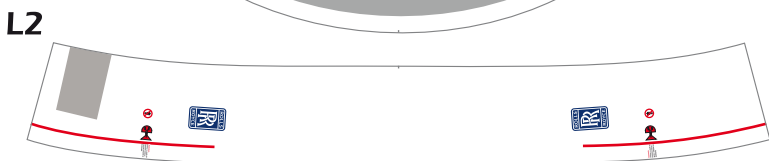
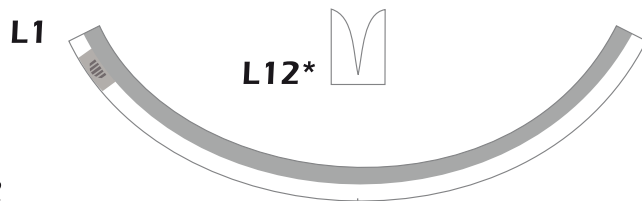
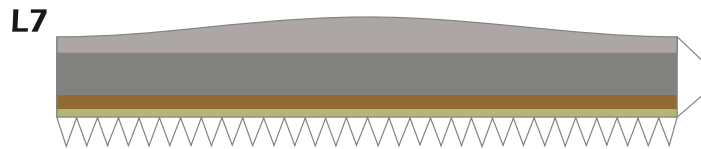
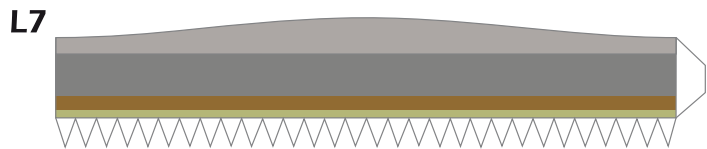
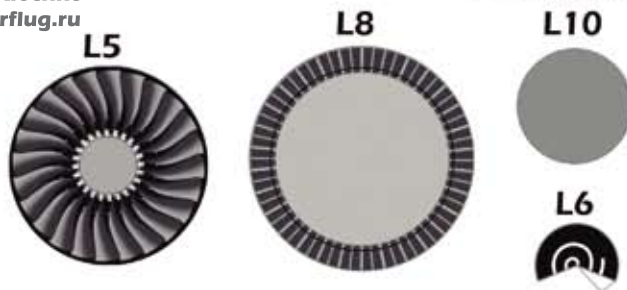
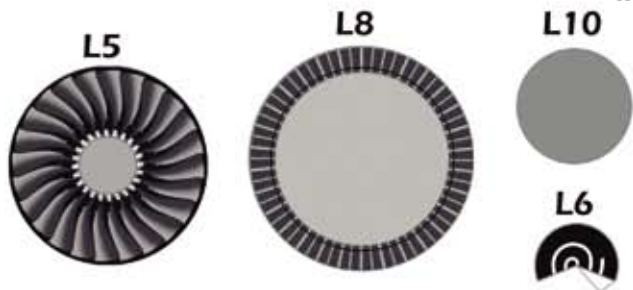

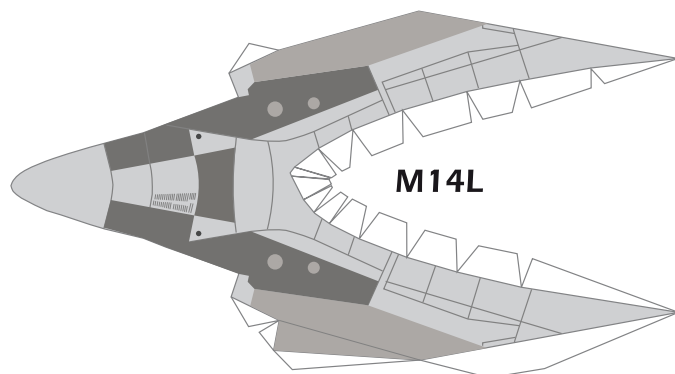
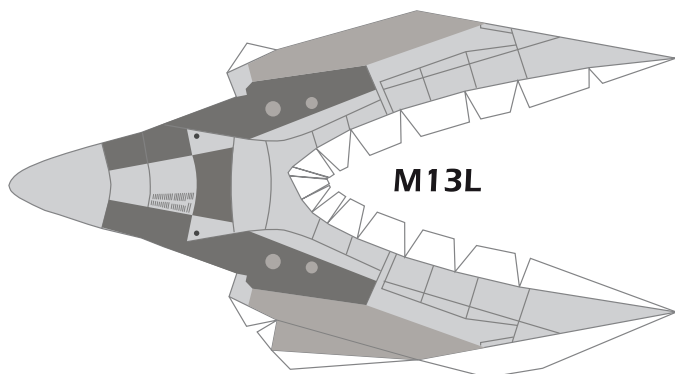
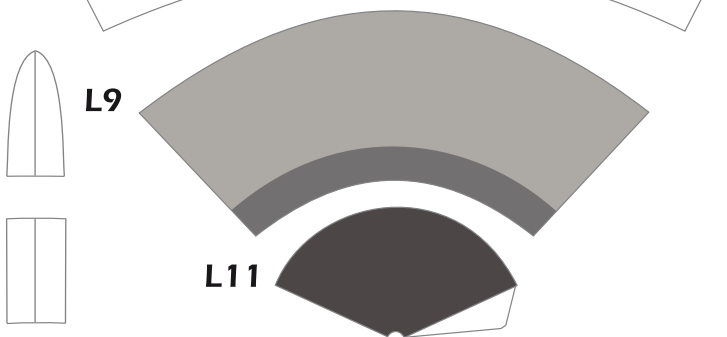
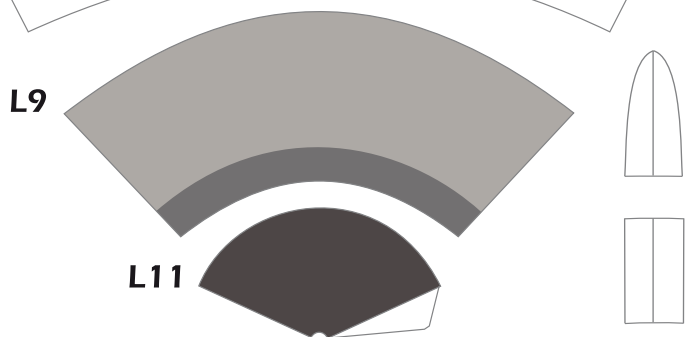
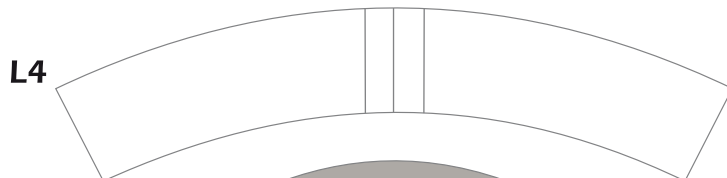
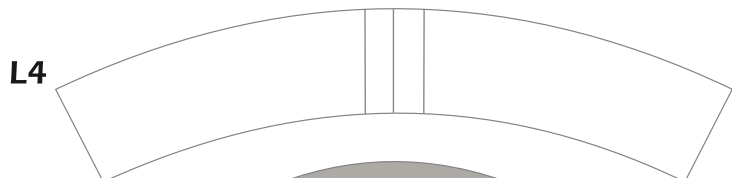
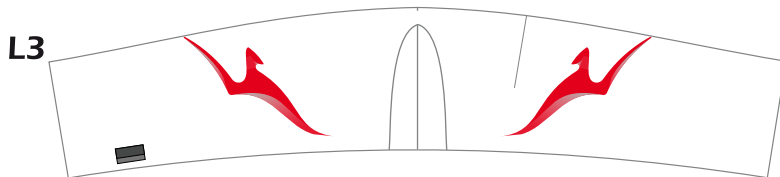
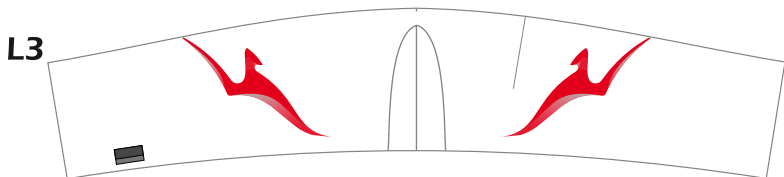
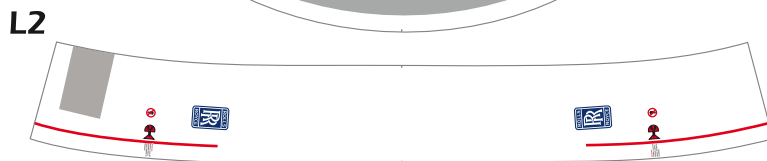
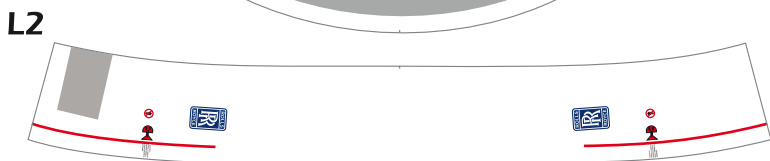
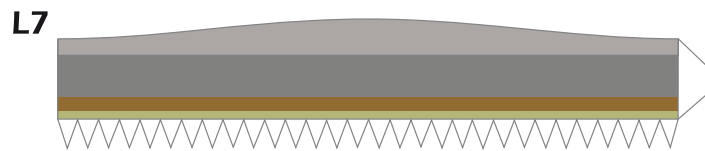
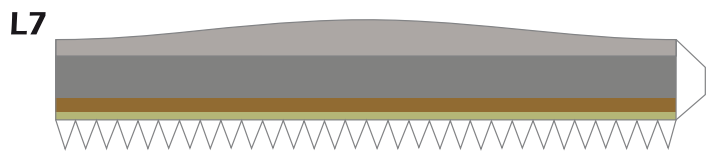
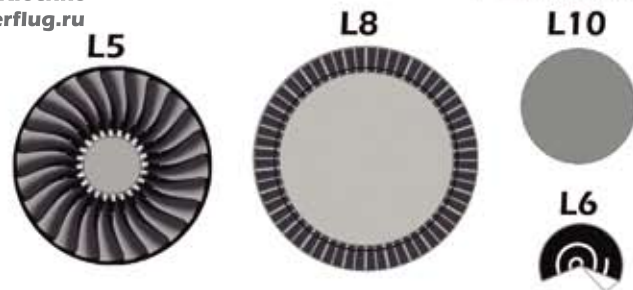
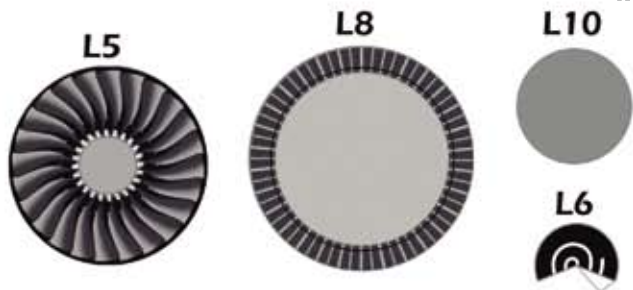

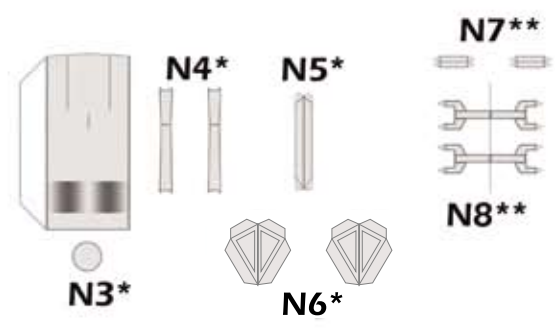
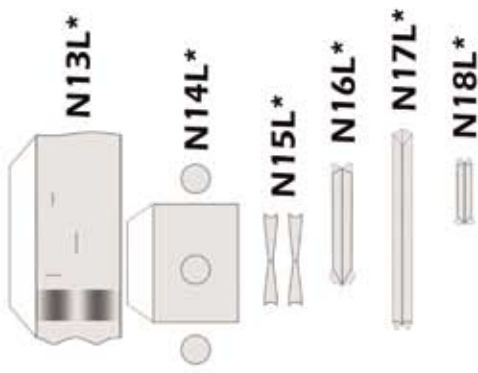
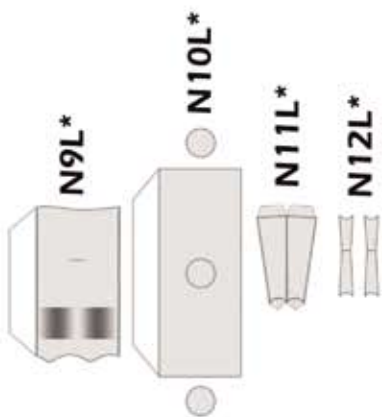
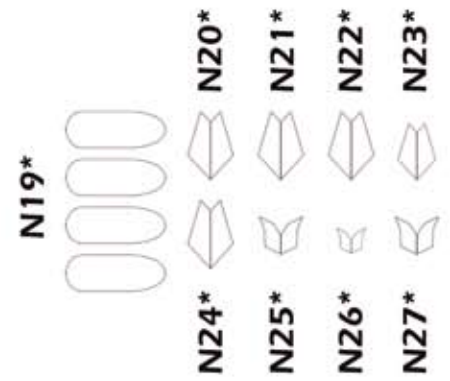
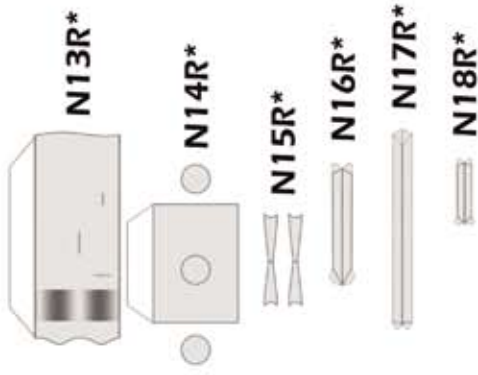
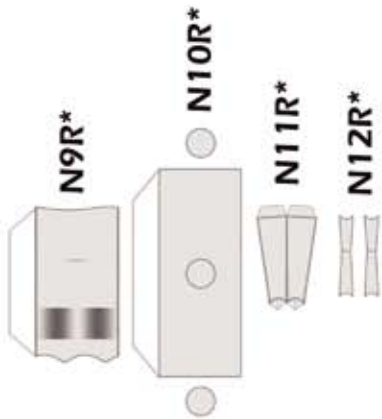
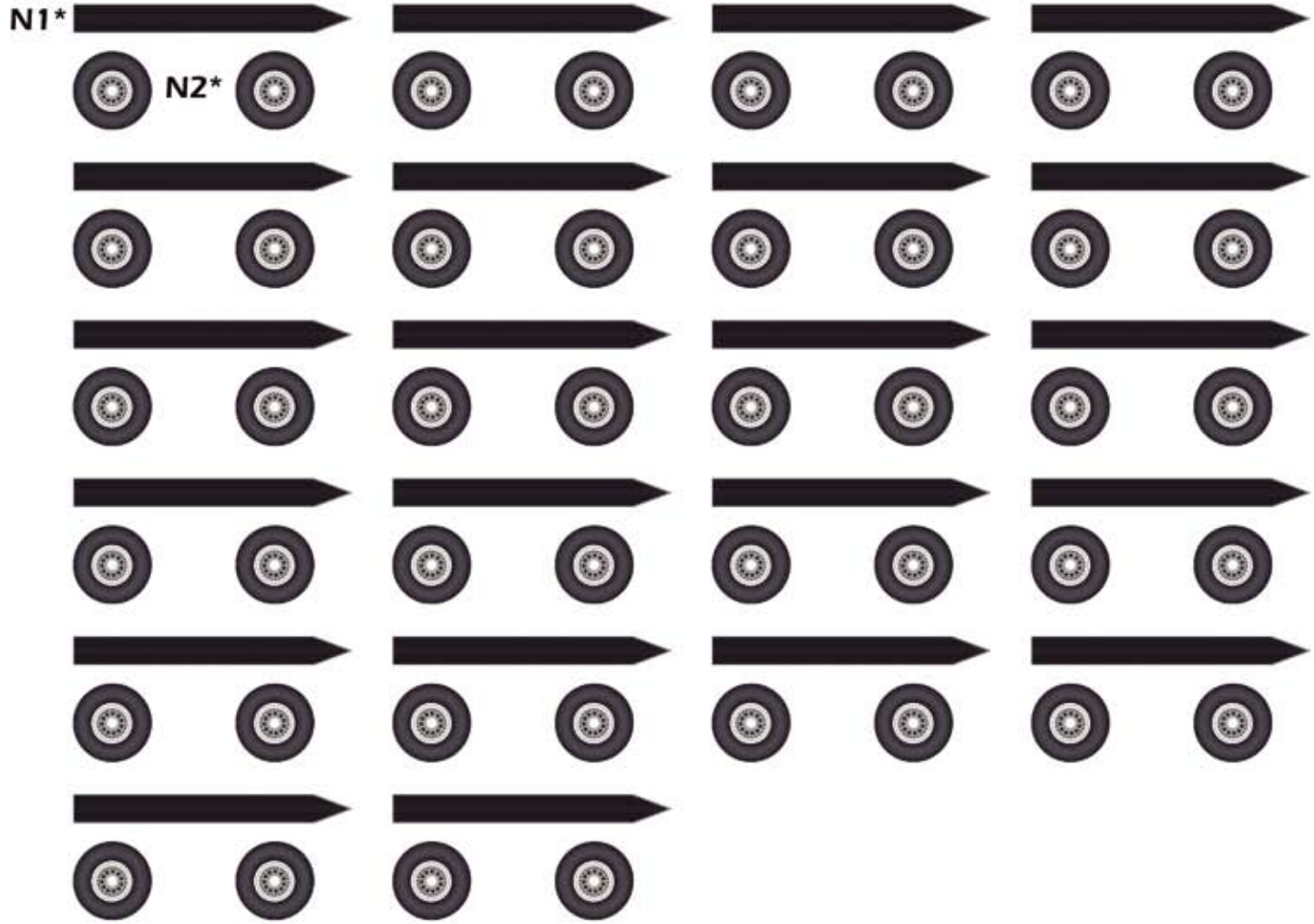

O3L

O1

O2R

HERMERCRAFT

DESIGNED BY EDWIN RODRIGUEZ
AIR FRANCE BY MARIO SOLORIZANO

O3R

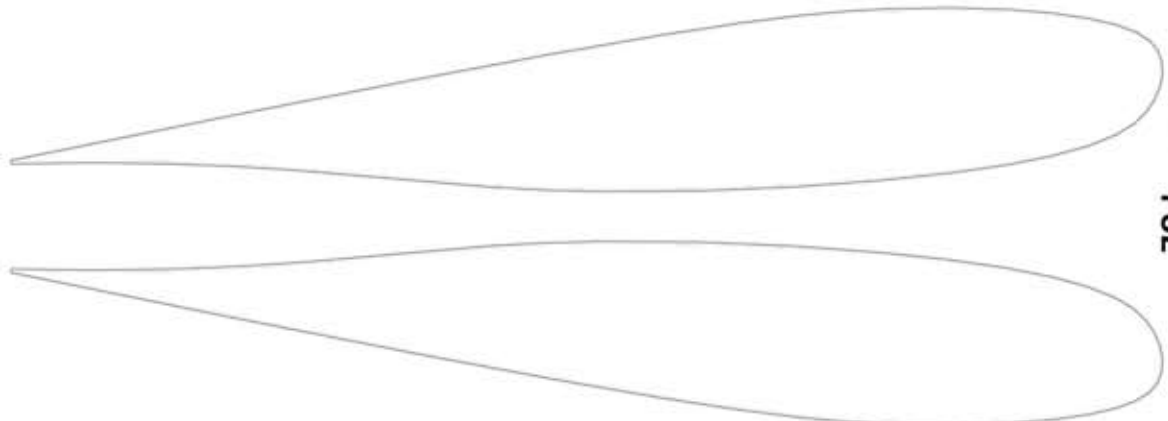
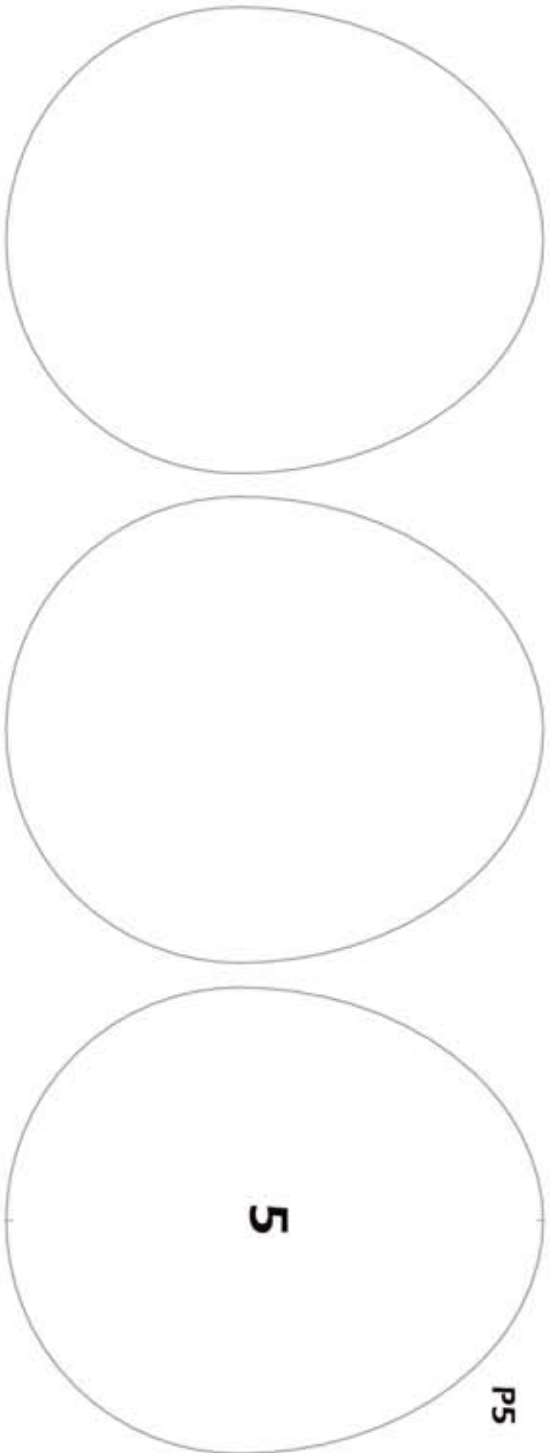
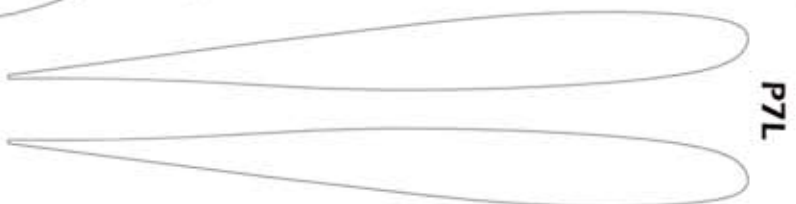
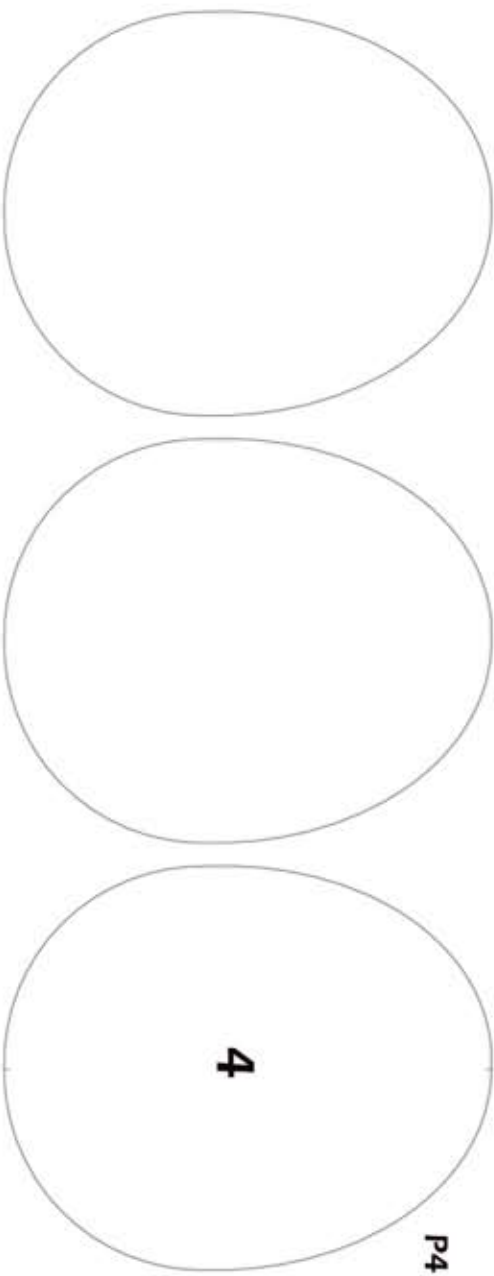
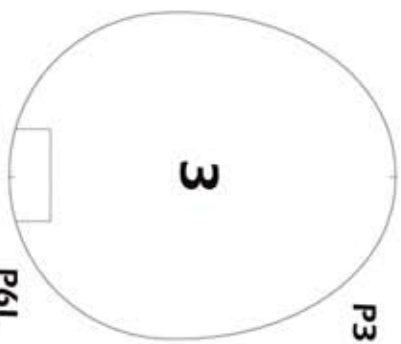
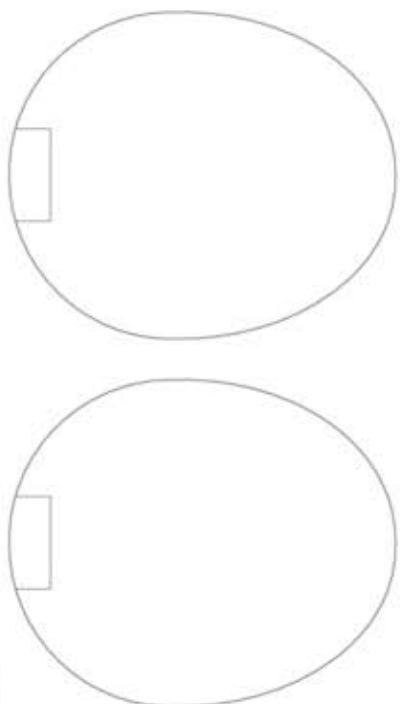
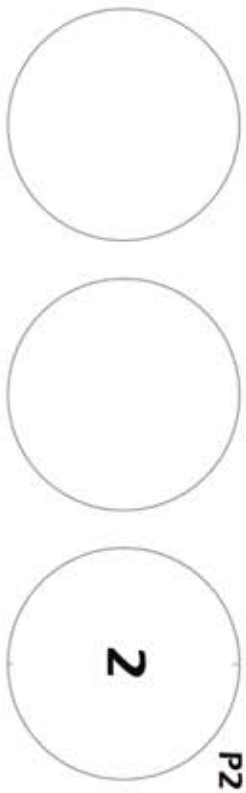

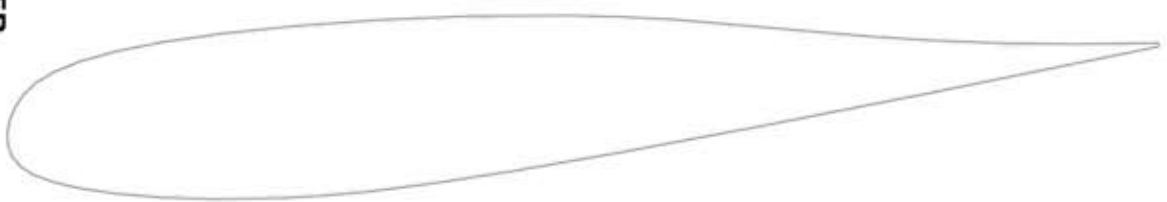
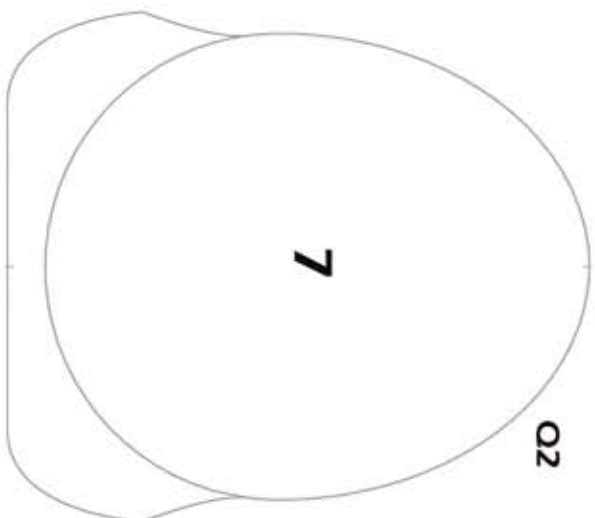
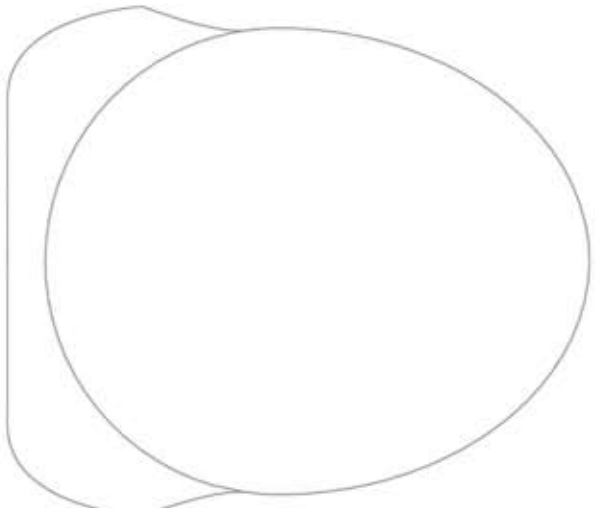
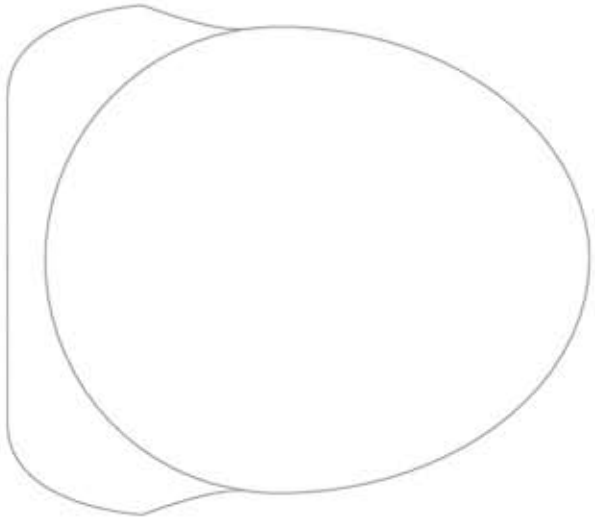
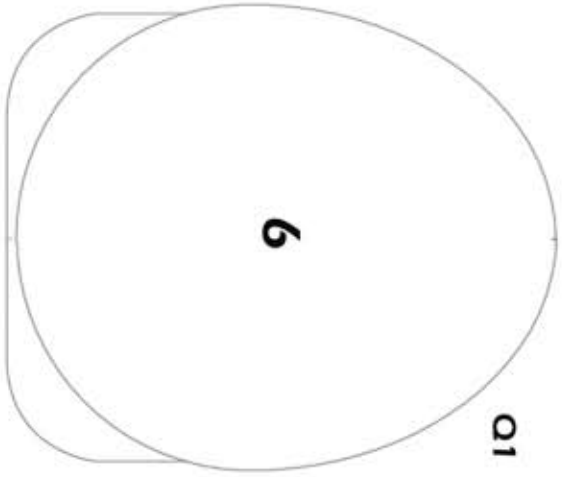
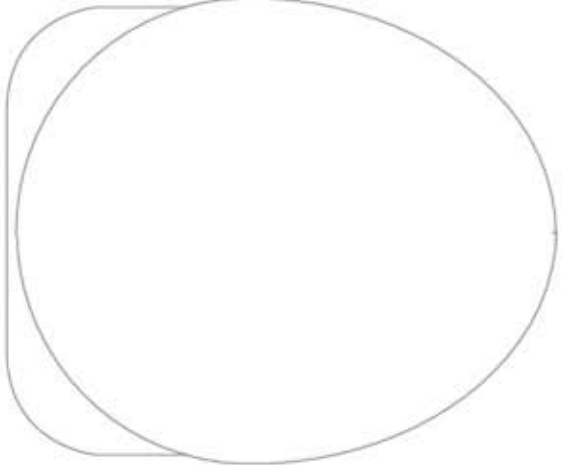
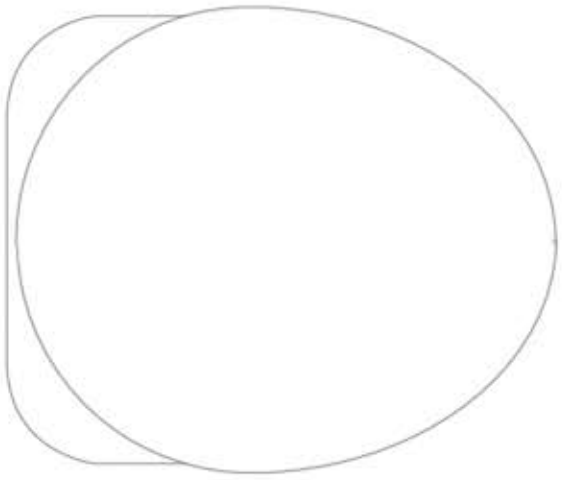

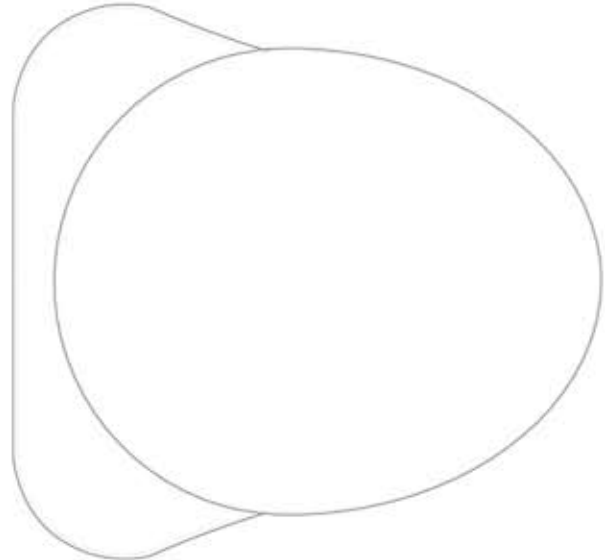

R1

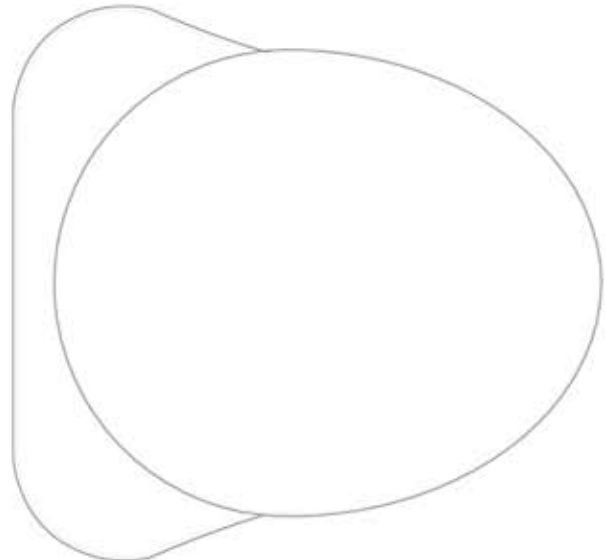

R2

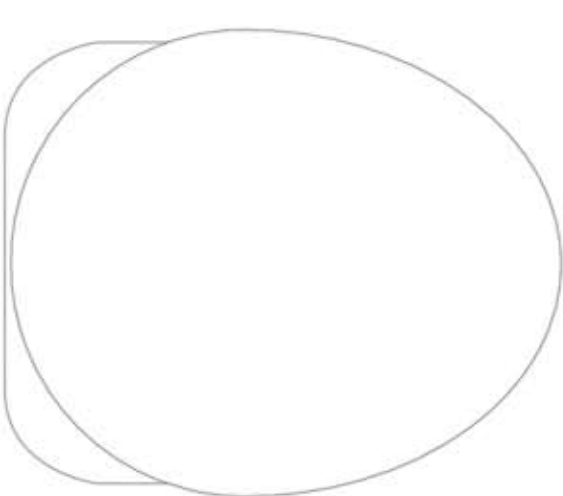

9

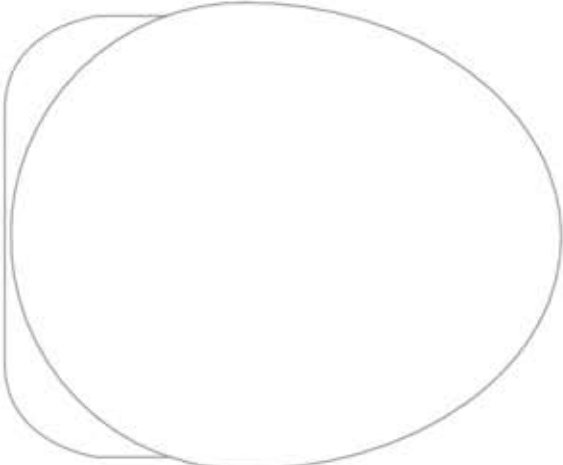

R4

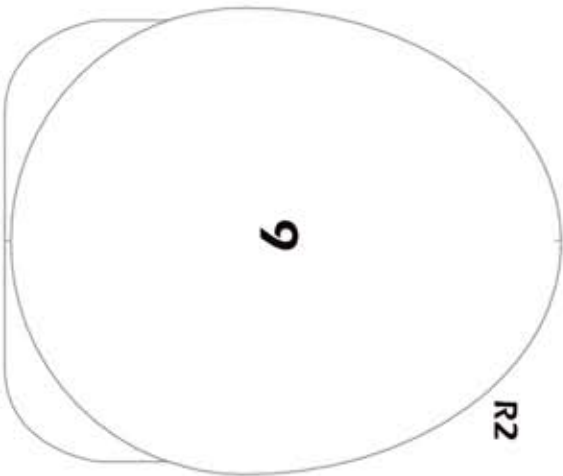

8

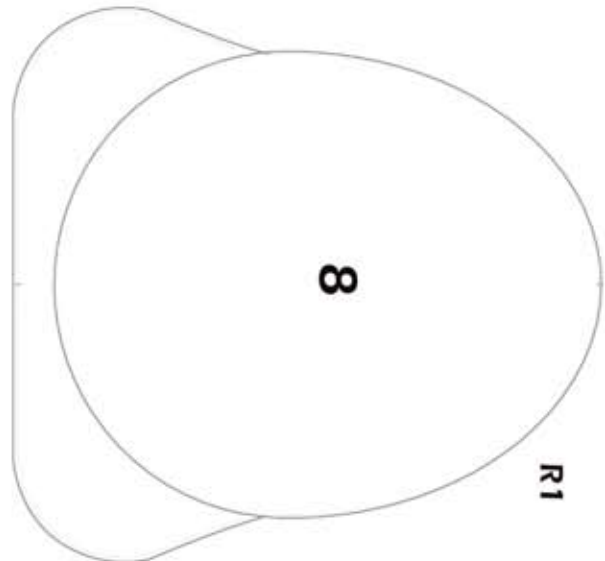

R5L

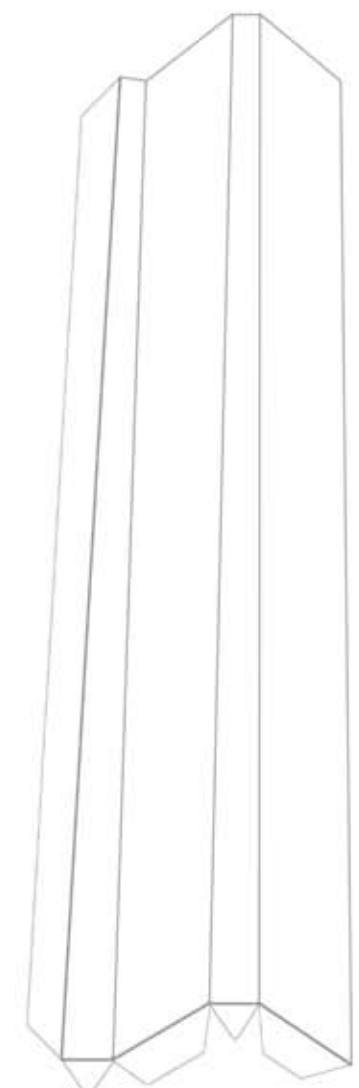

R5R

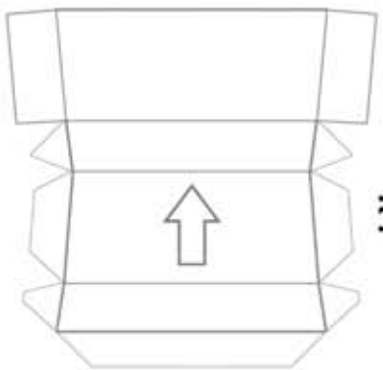

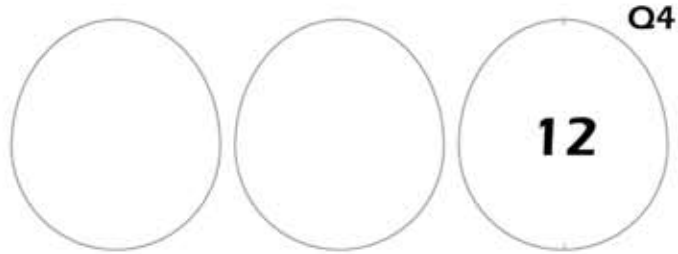
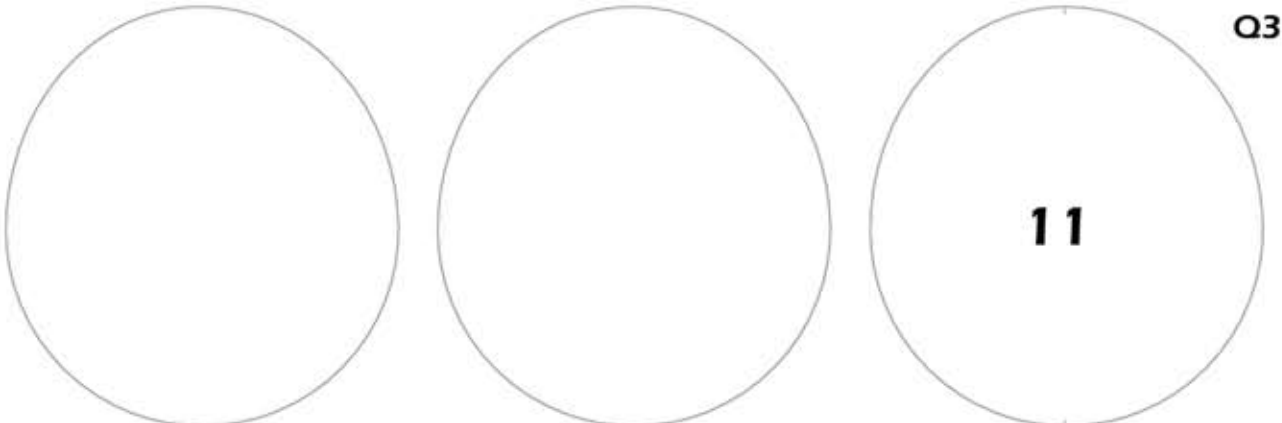
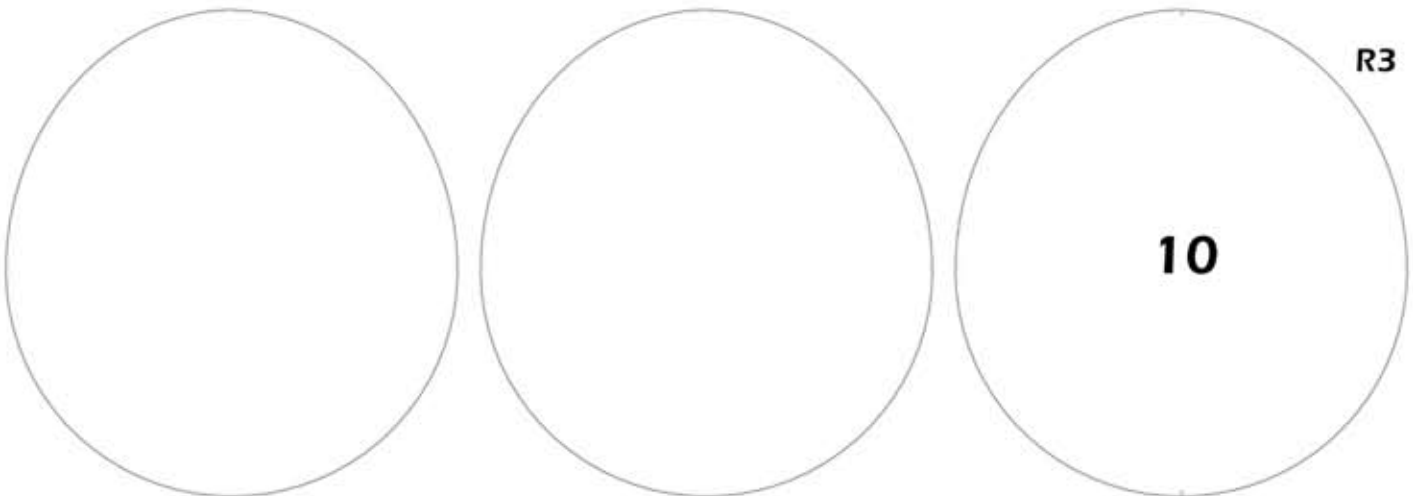

FREE MODEL, DO NOT SELL THE FILES!!!

