

A15L* 625

A15R* 625

AIRBUS A380-800 ASIANA AIRLINES



HERMERCRAFT

© 2019 Edwin Rodriguez

HERMERCRAFT

Redraw By Mario Solorzano
Repaint By Michael Tsai

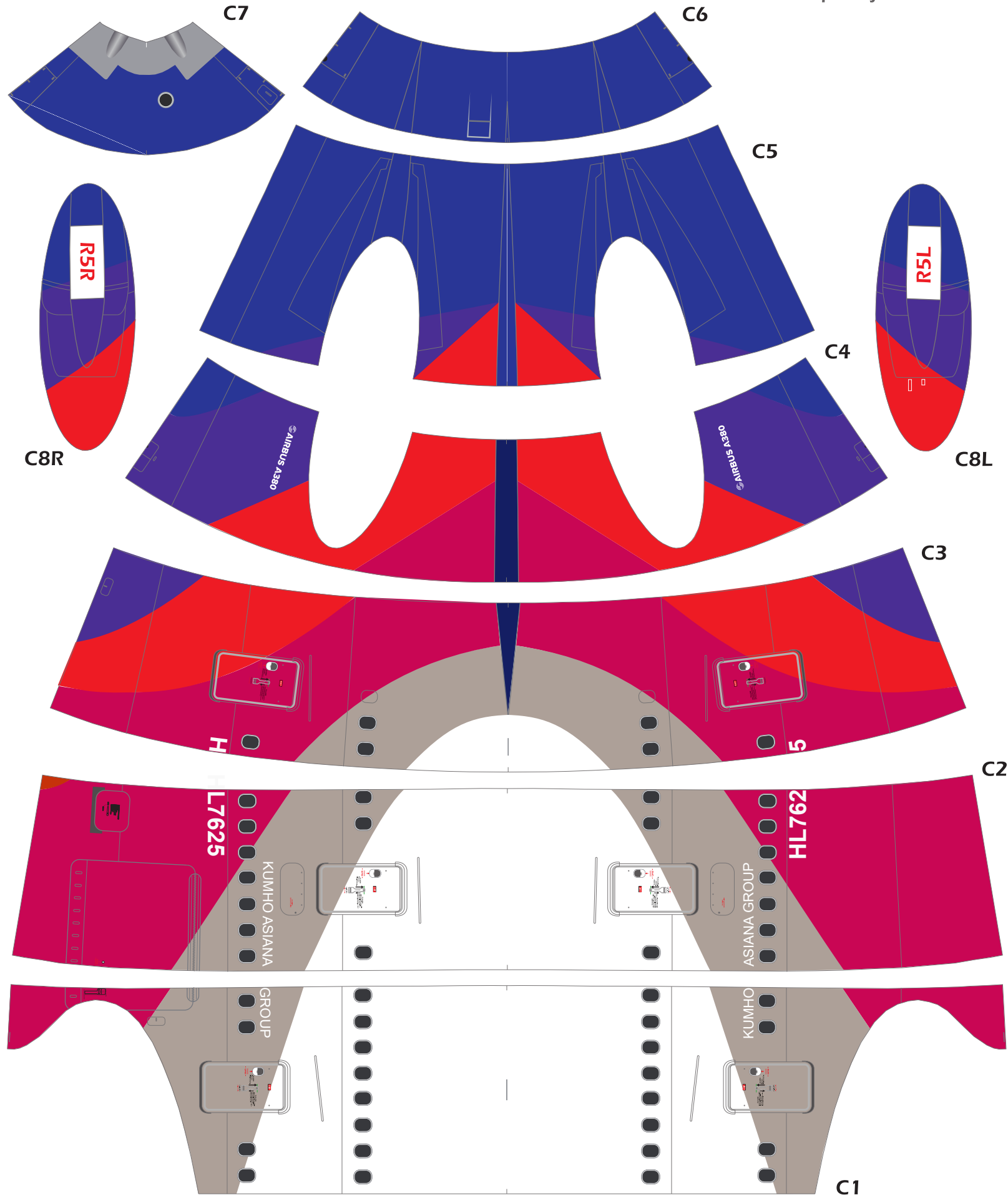

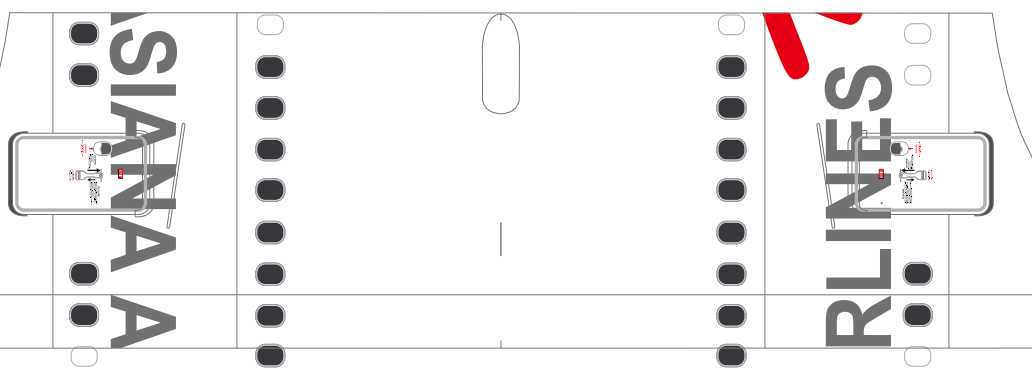
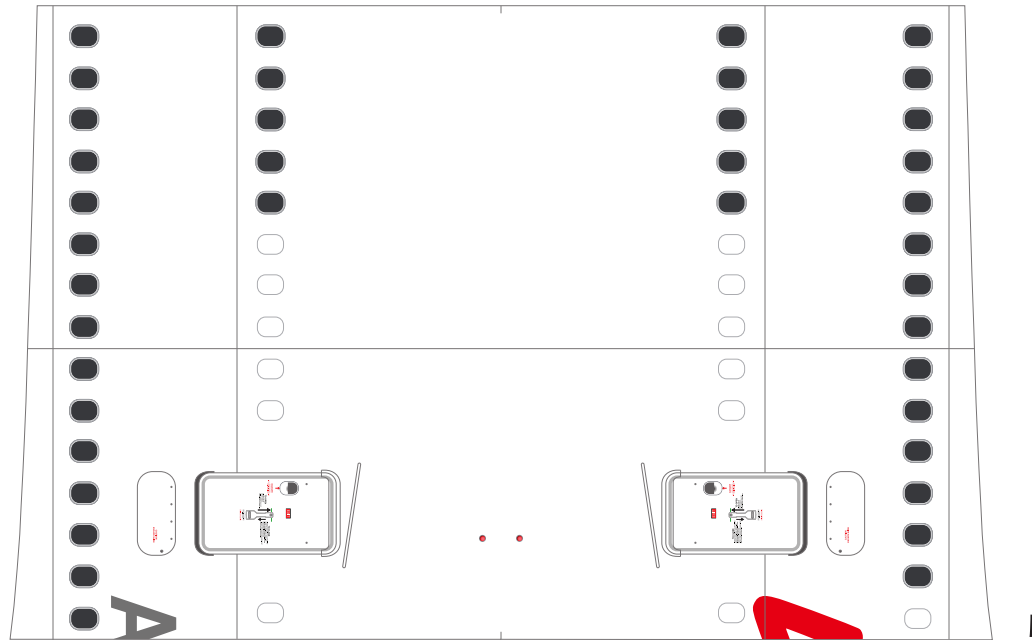
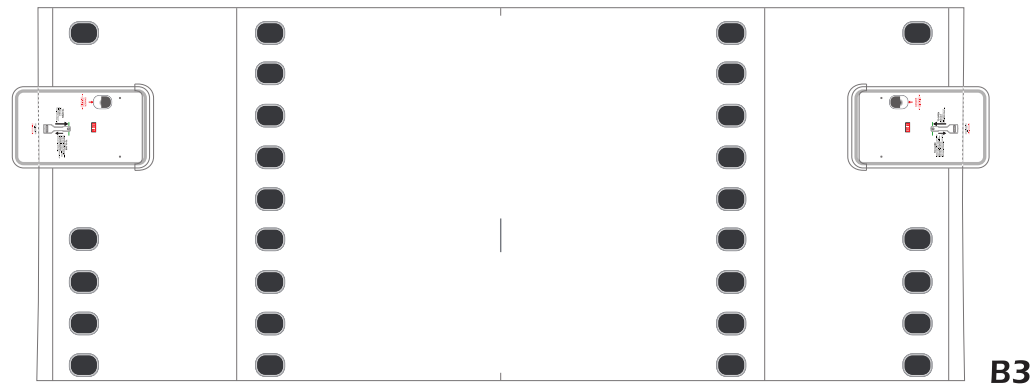
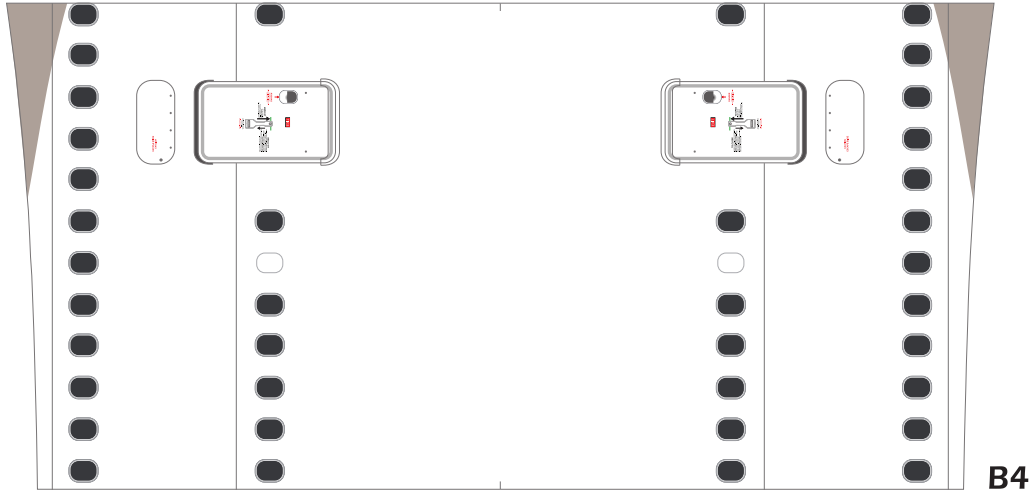

ASIANA AIRLINES

ASIANA AIRLINES





D6

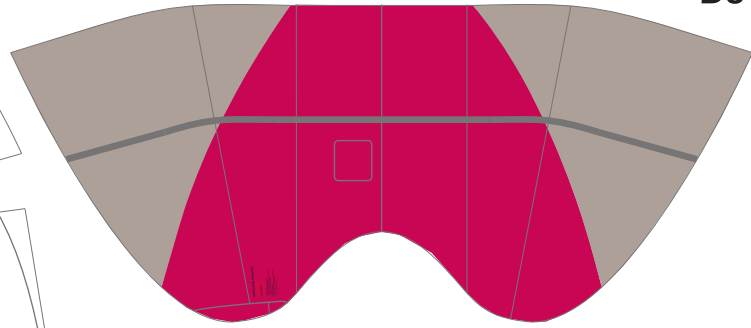

D1

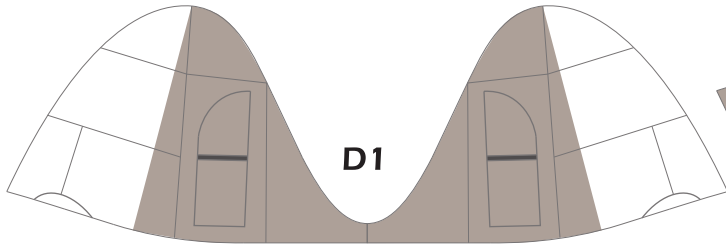

D2

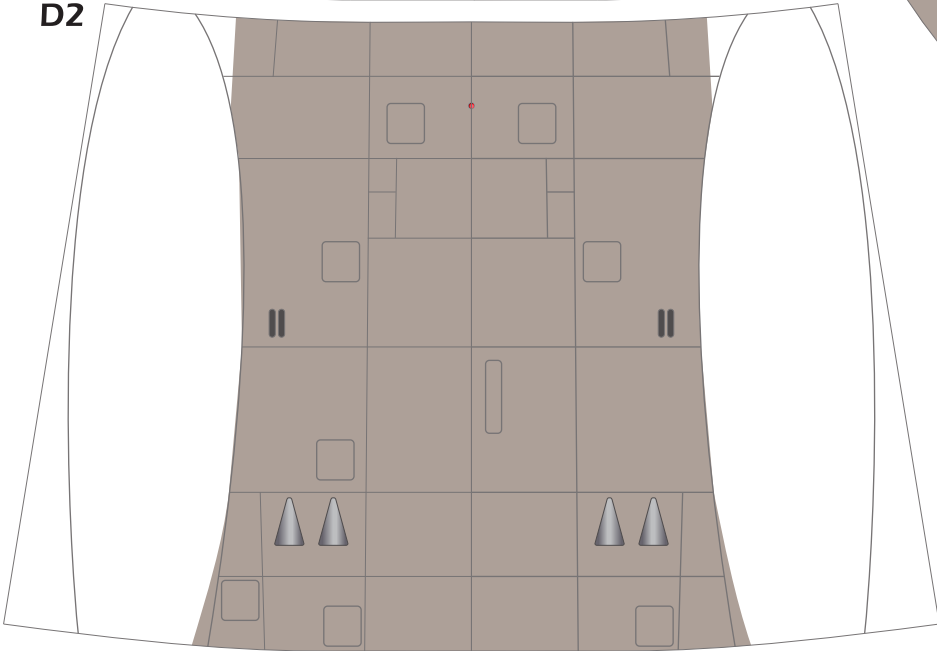

D8L*



D9L*



D9R*

D8R*

D3

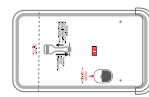

B3+D3 left door

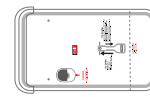

B3+D3 right door

D7R*

D7L*

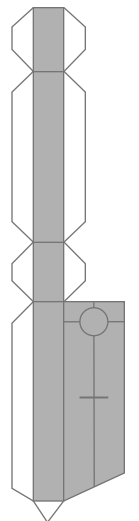

D4

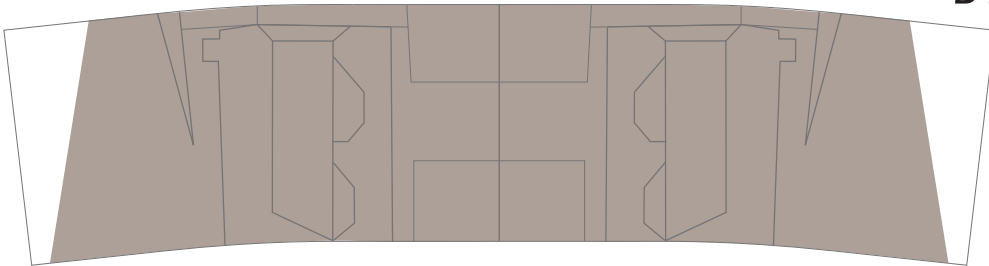

D5

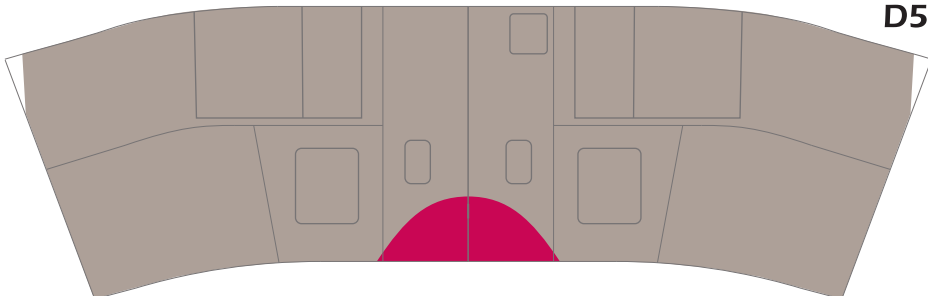

AIRBUS A380-800 ASIANA AIRLINES



HERMERCRAFT

© 2019 Edwin Rodriguez

HERMERCRAFT

Redraw By Mario Solorzano

Repaint By Michael Tsai

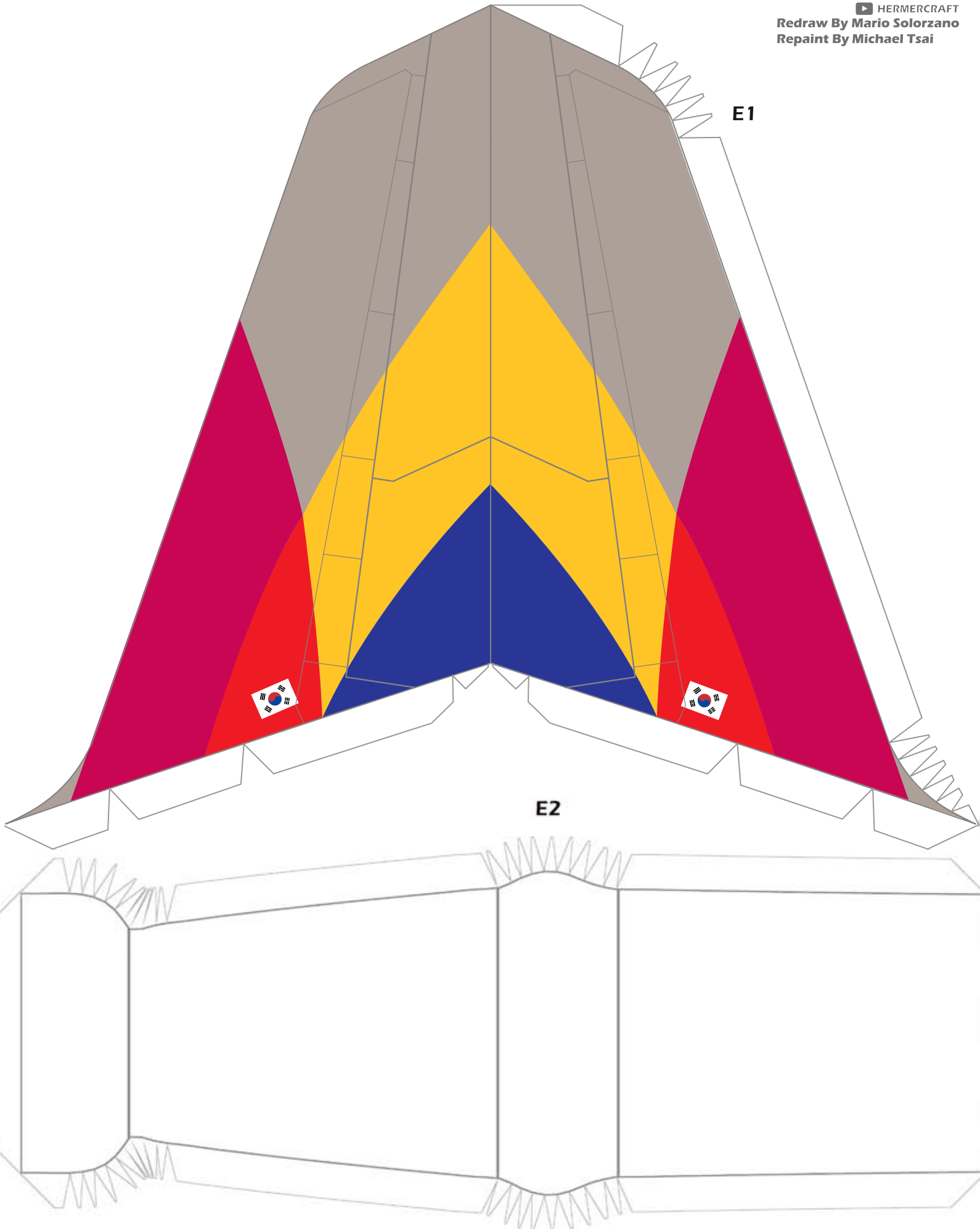



F1L

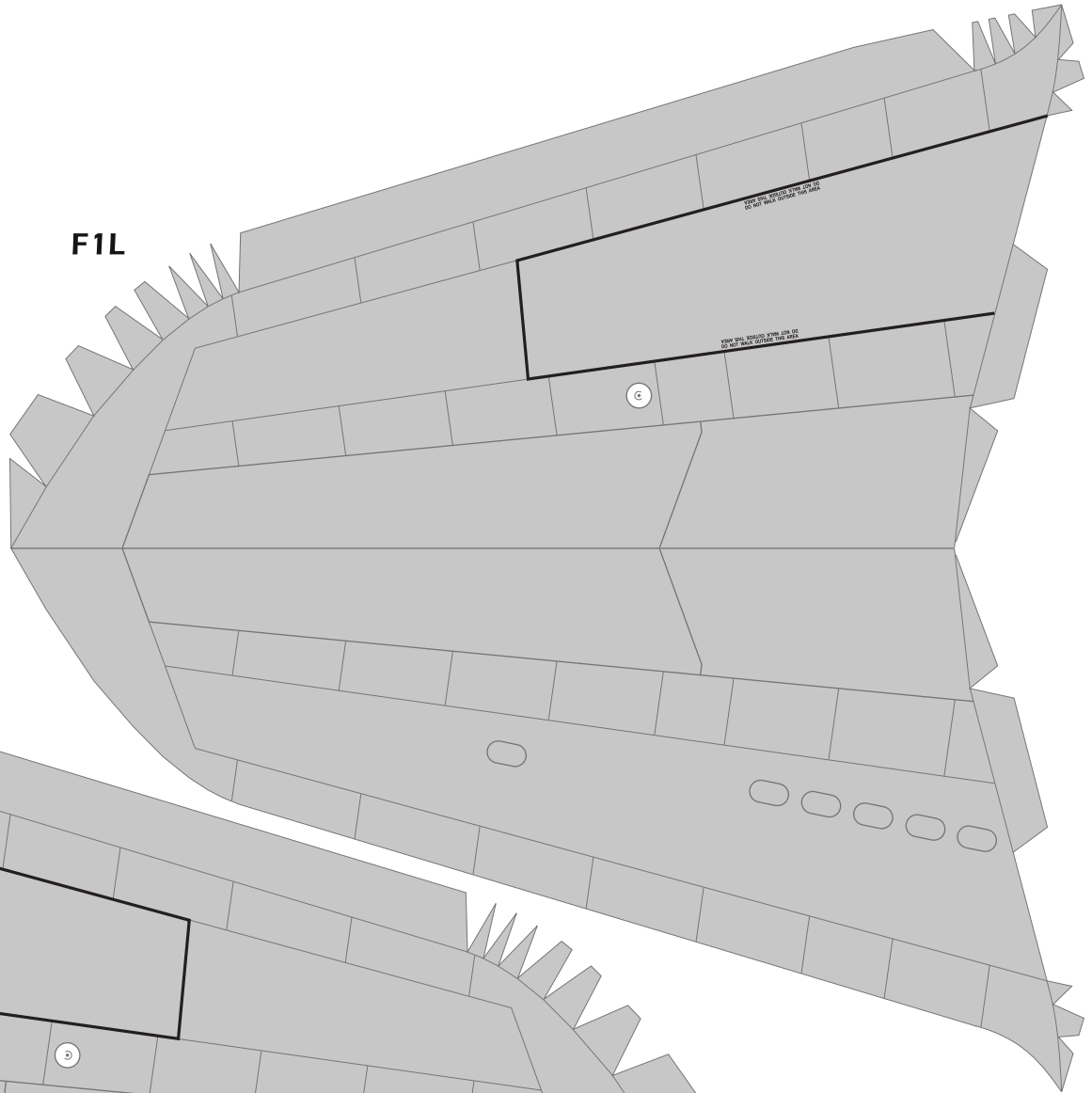

F1R

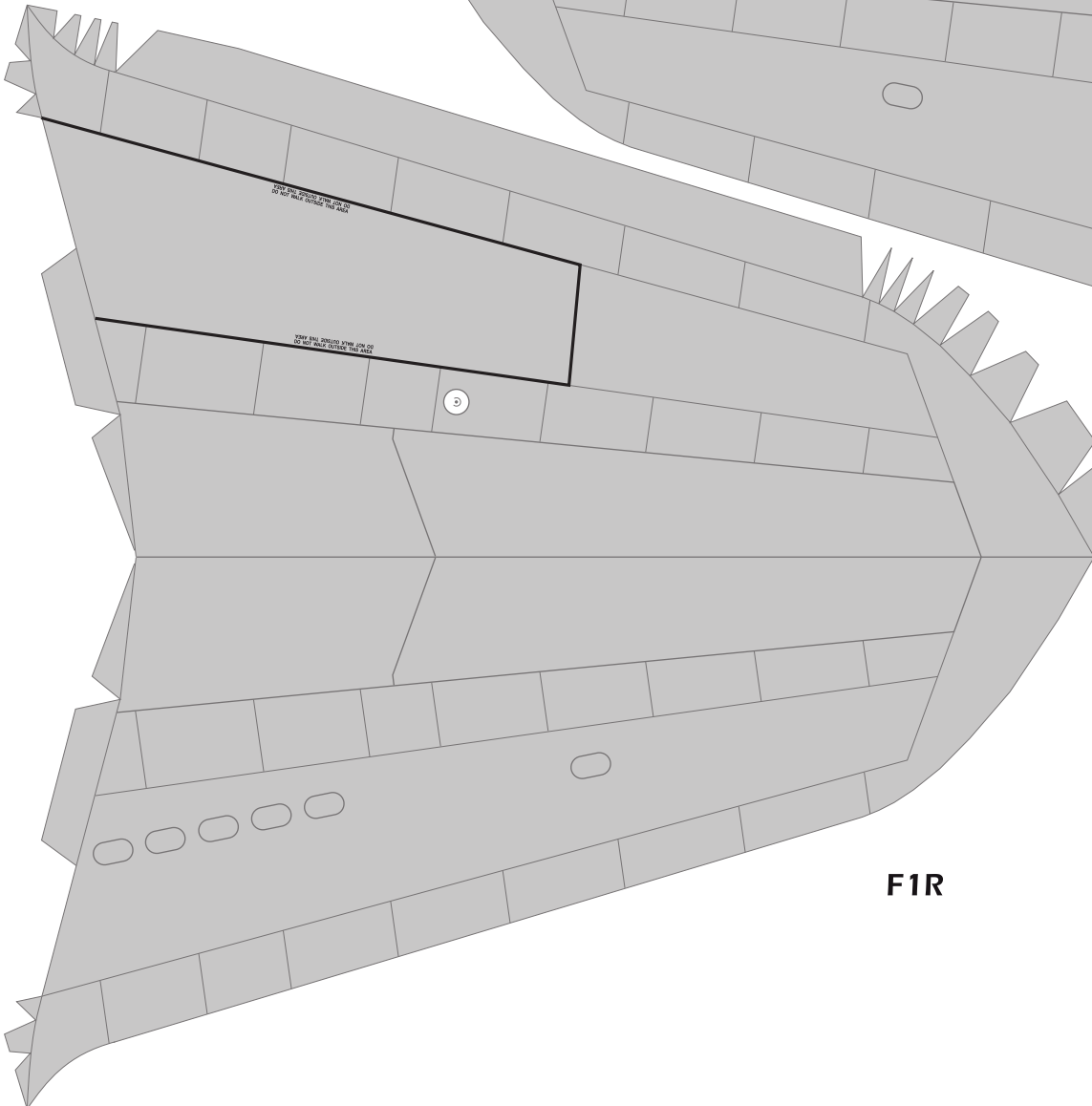

AIRBUS A380-800 ASIANA AIRLINES



HERMERCRAFT

© 2019 Edwin Rodriguez

HERMERCRAFT

Redraw By Mario Solorzano
Repaint By Michael Tsai

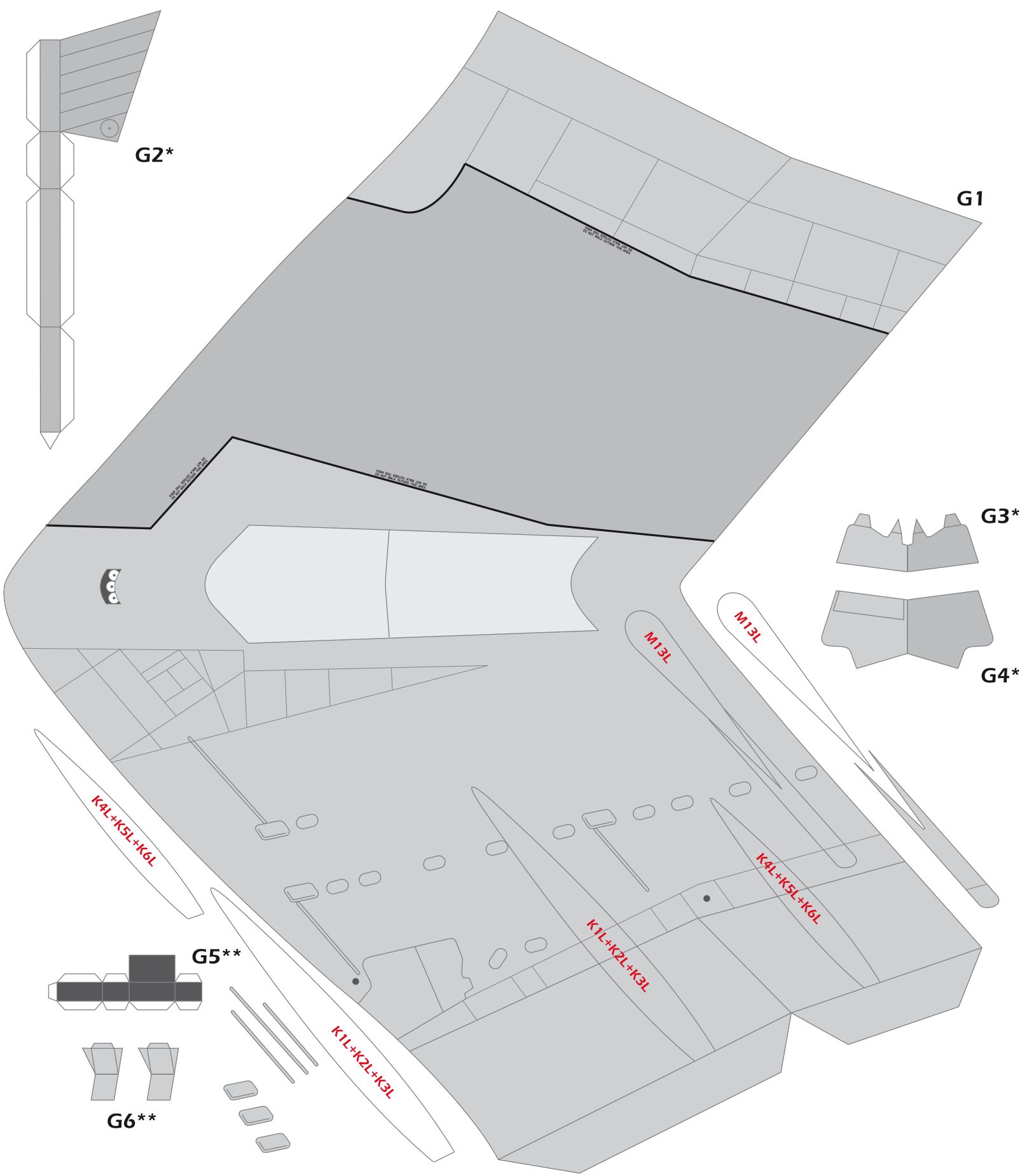

AIRBUS A380-800 ASIANA AIRLINES



HERMERCRAFT

© 2019 Edwin Rodriguez

HERMERCRAFT

Redraw By Mario Solorzano

Repaint By Michael Tsai

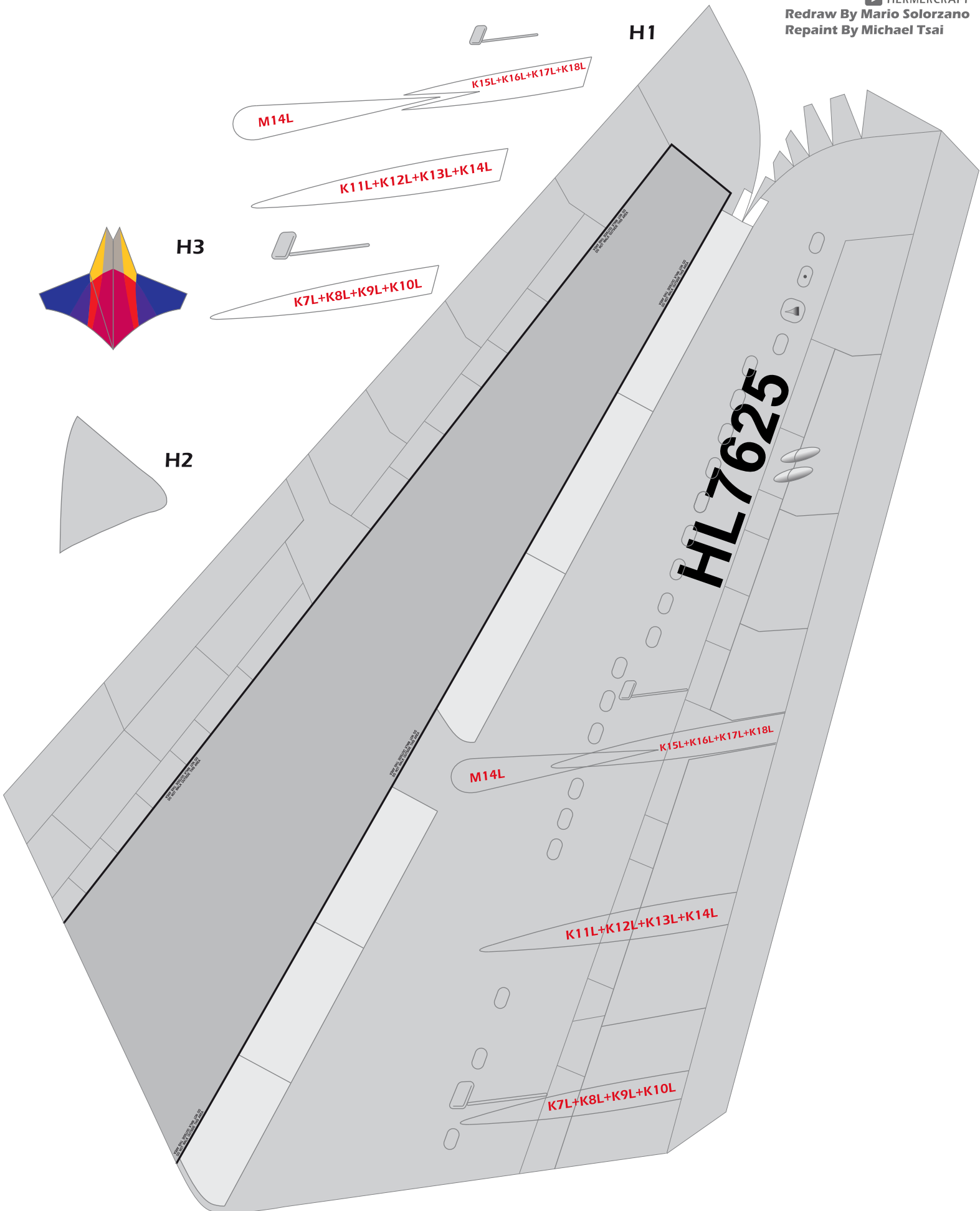

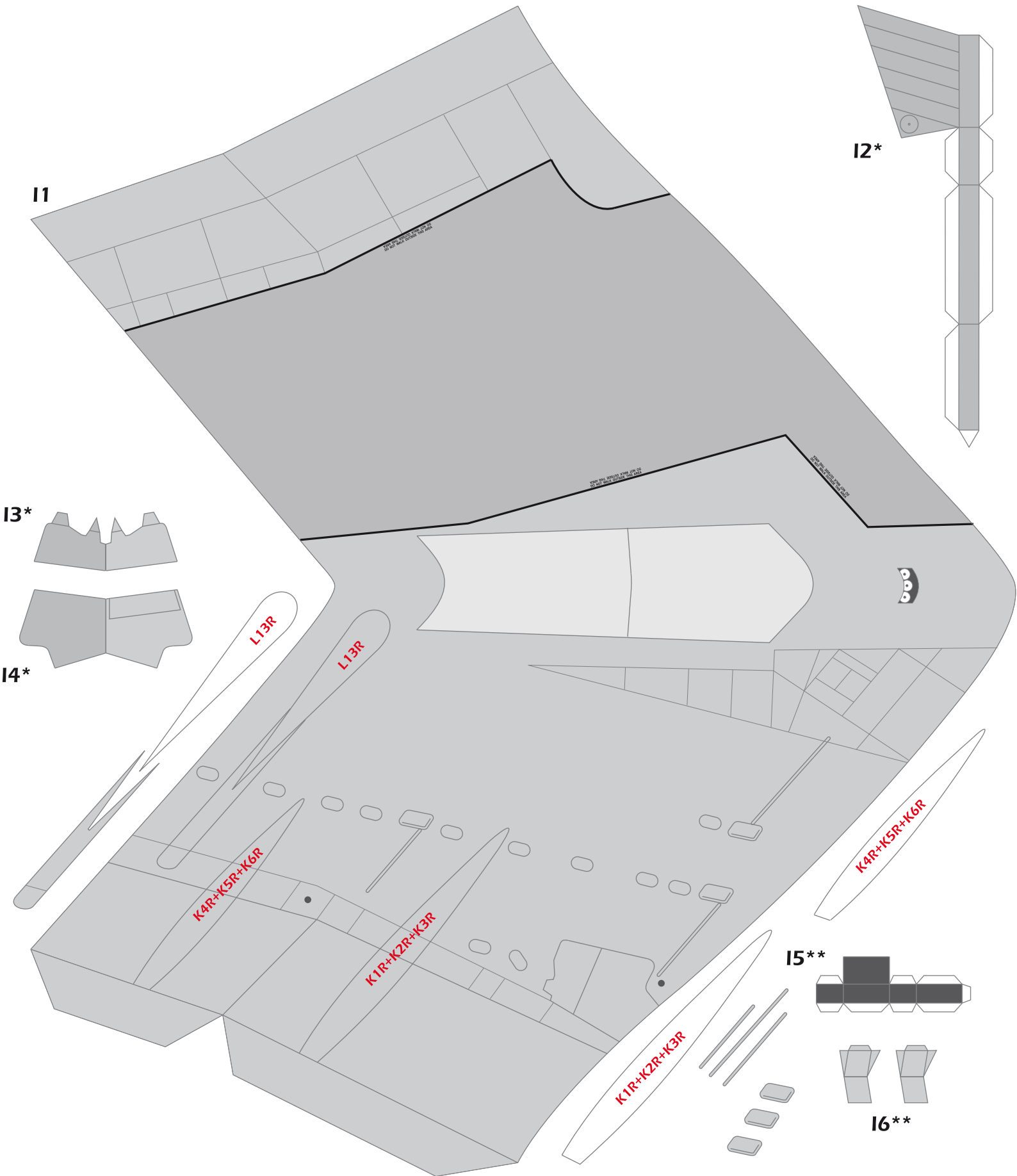

AIRBUS A380-800 ASIANA AIRLINES



HERMERCRAFT

© 2019 Edwin Rodriguez

HERMERCRAFT

Redraw By Mario Solorzano

Repaint By Michael Tsai

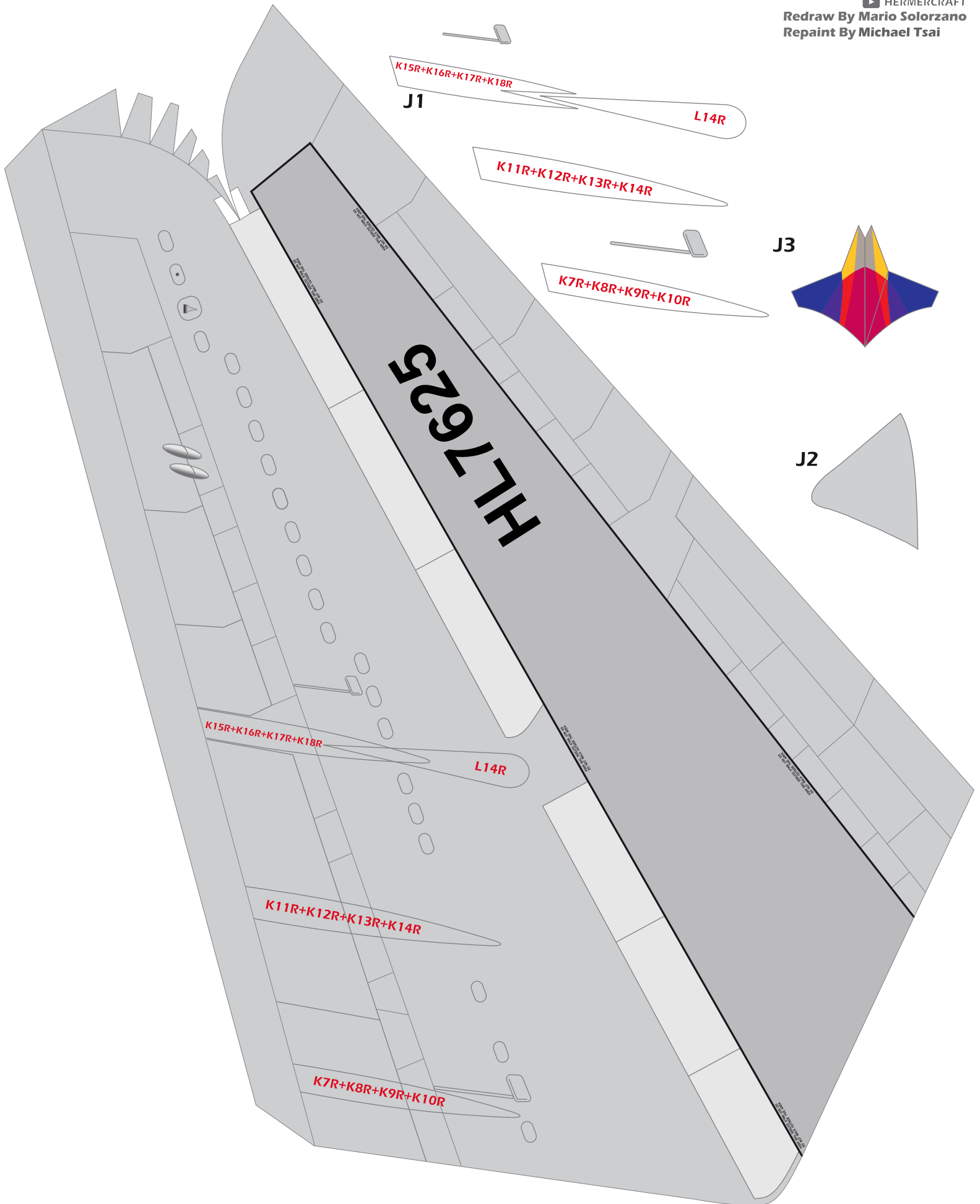

J1

L14R

K11R+K12R+K13R+K14R

J3

K7R+K8R+K9R+K10R

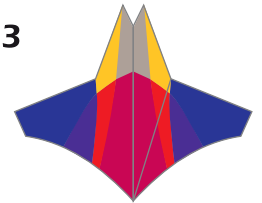

J2

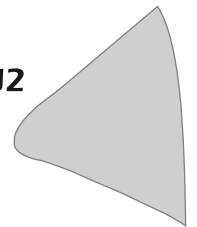

AIRBUS A380-800 ASIANA AIRLINES



HERMERCRAFT

© 2019 Edwin Rodriguez

HERMERCRAFT

Redraw By Mario Solorzano
Repaint By Michael Tsai

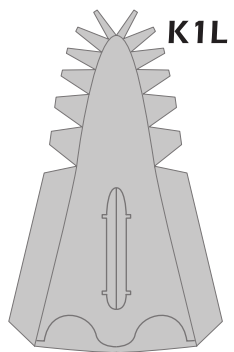

K1L

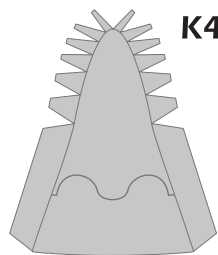

K4L

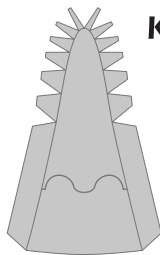

K7L

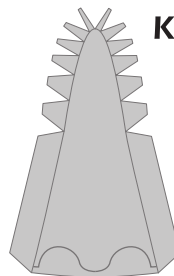

K11L

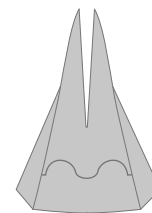

K15L



K5L



K8L



K12L

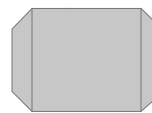

K16L



K2L

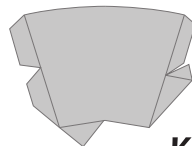

K6L

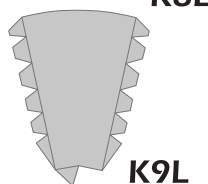

K9L

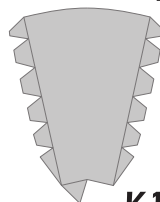

K13L

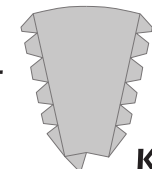

K17L

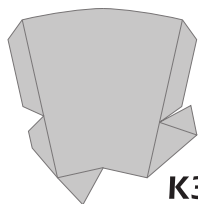

K3L



K10L



K14L



K18L

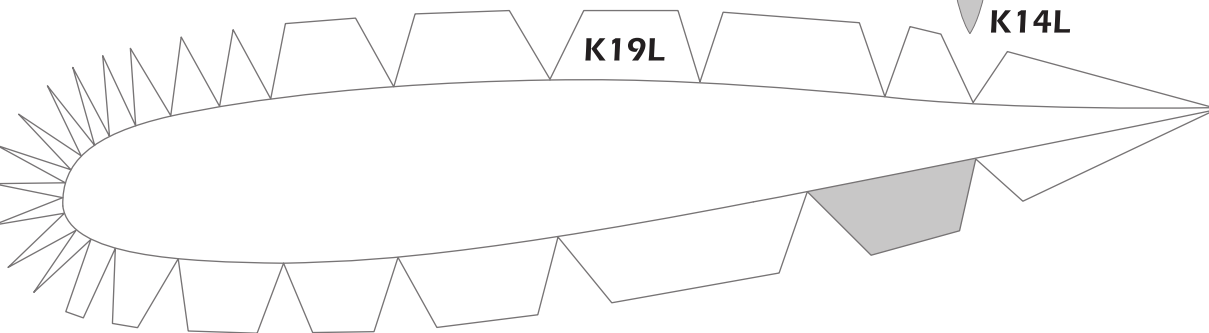

K19L

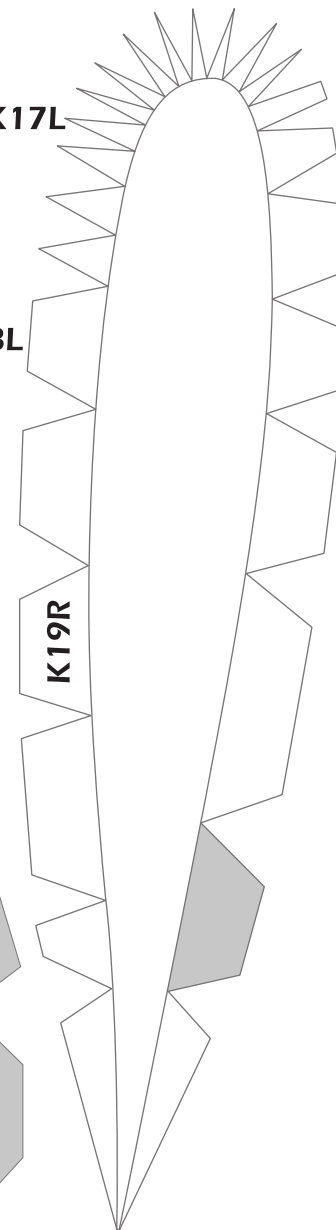

K19R

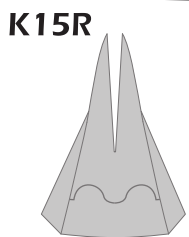

K15R

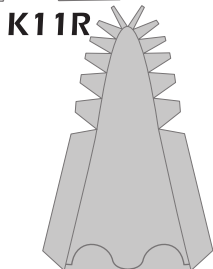

K11R

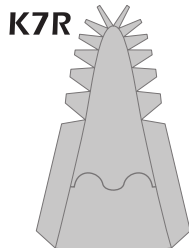

K7R

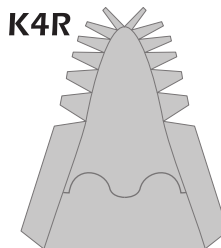

K4R

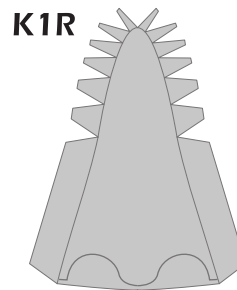

K1R

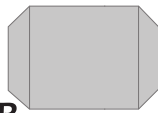

K16R



K8R



K5R

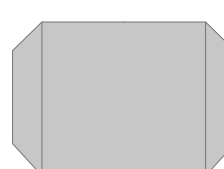

K2R

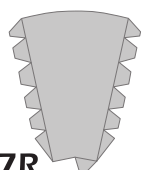

K12R

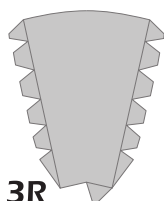

K9R

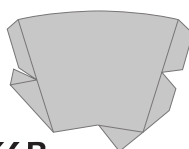

K6R

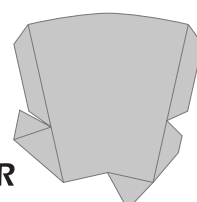

K3R

K17R



K18R

K13R



K14R



K10R

AIRBUS A380-800 ASIANA AIRLINES



HERMERCRAFT

© 2019 Edwin Rodriguez

Redraw By Mario Solorzano
Repaint By Michael Tsai

HERMERCRAFT

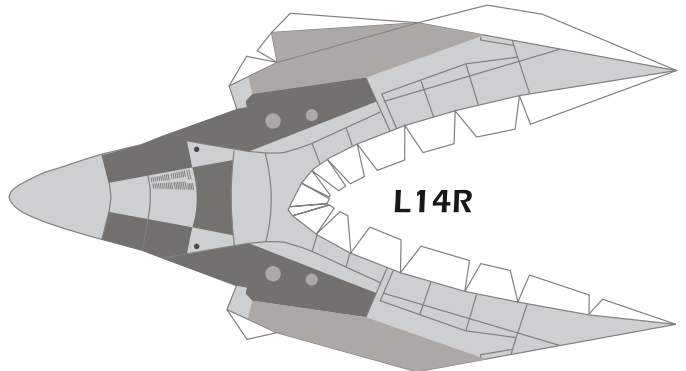
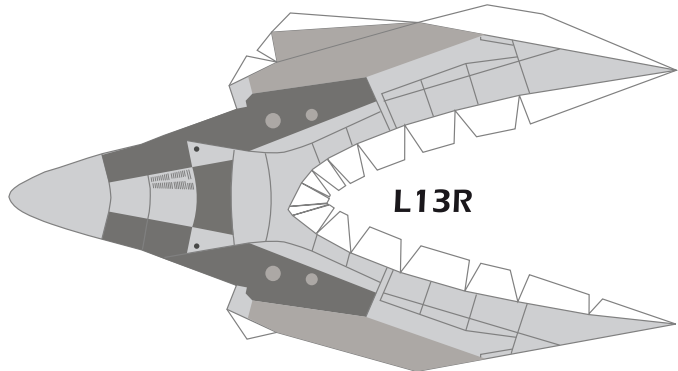
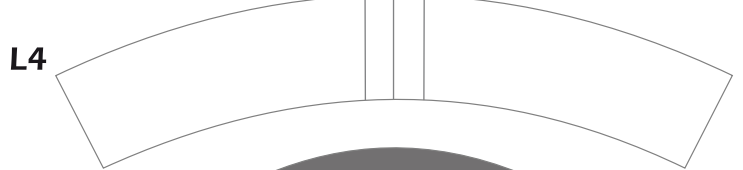
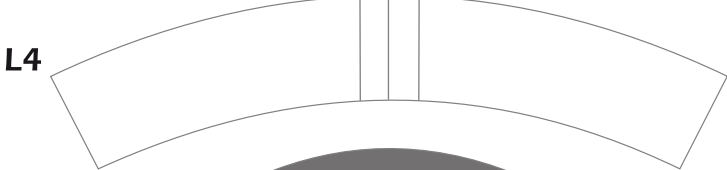
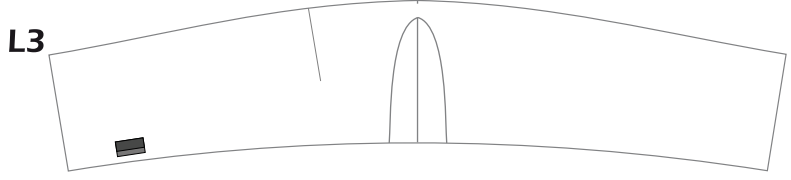
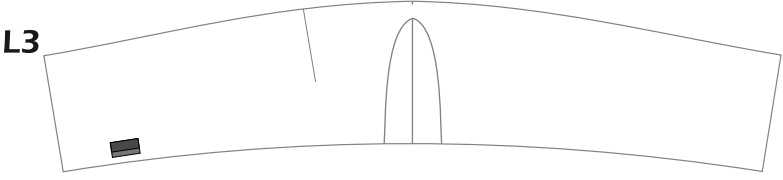
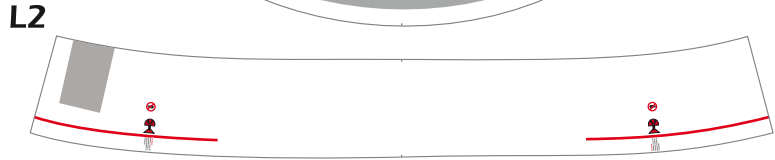
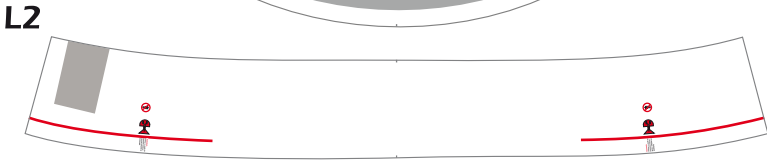
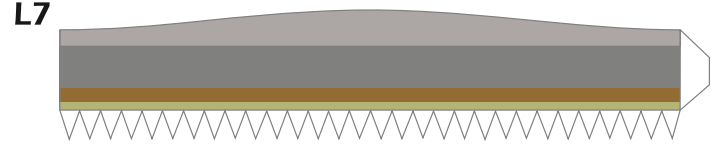
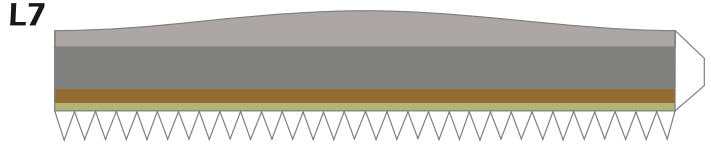
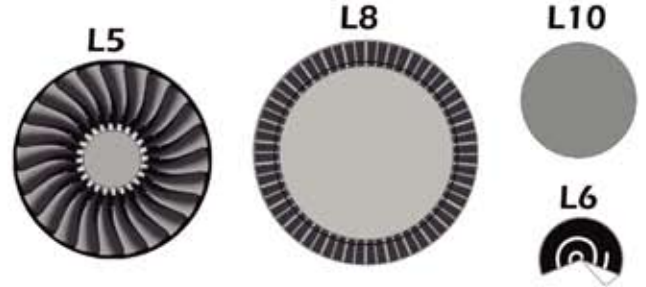
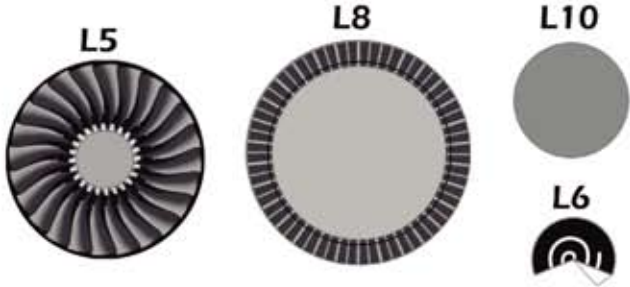

AIRBUS A380-800 ASIANA AIRLINES



HERMERCRAFT

© 2019 Edwin Rodriguez

Redraw By Mario Solorzano
Repaint By Michael Tsai

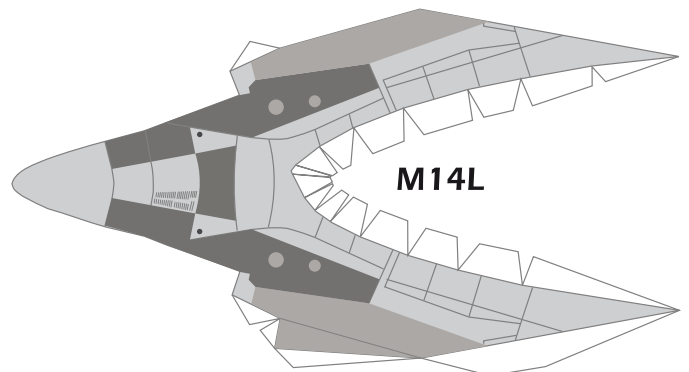
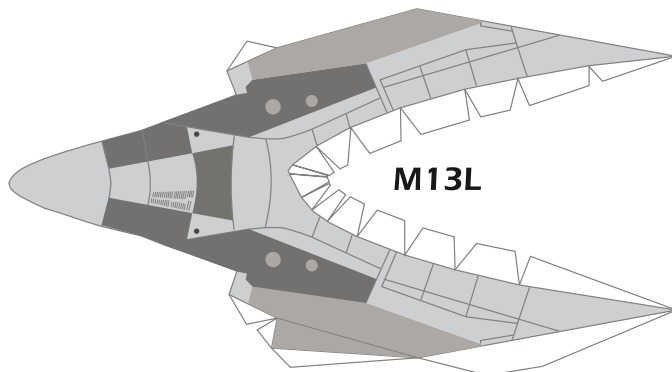
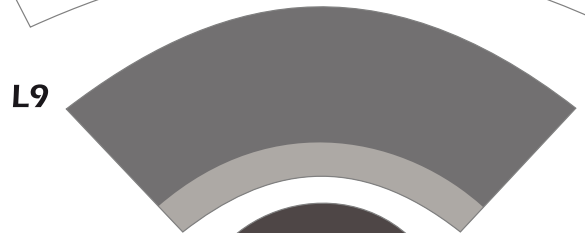
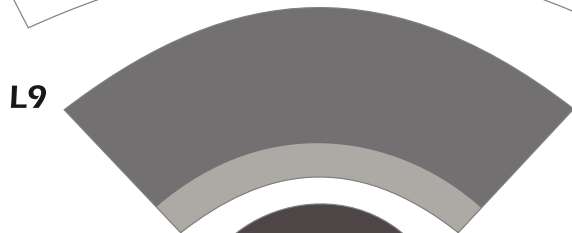
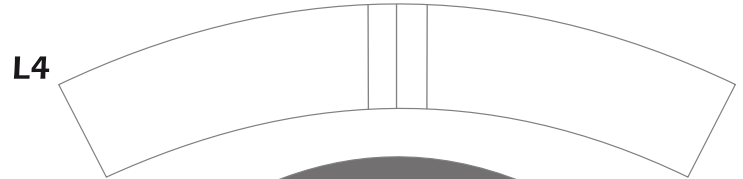
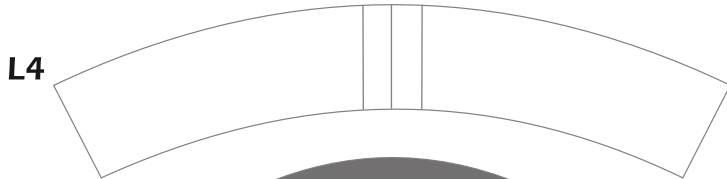
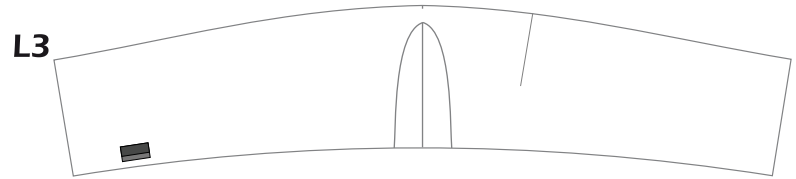
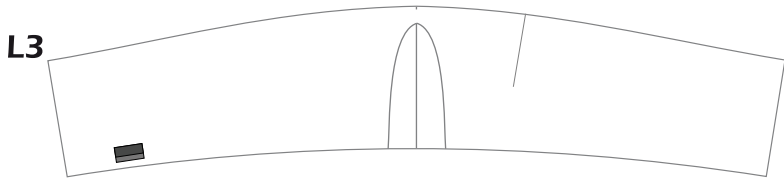
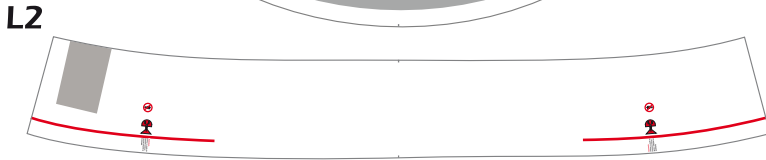
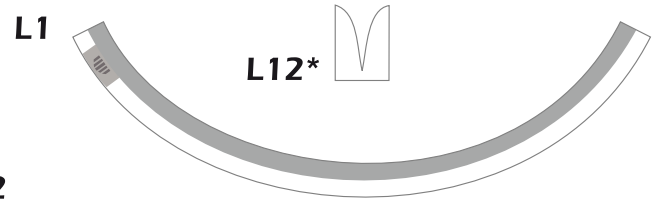
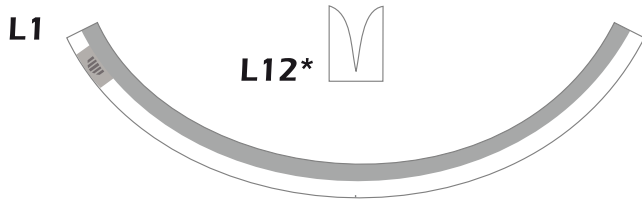
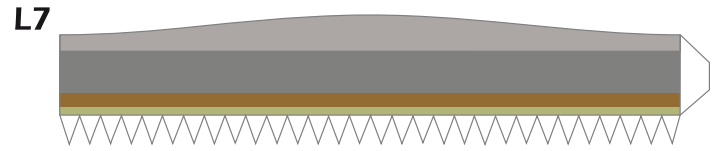
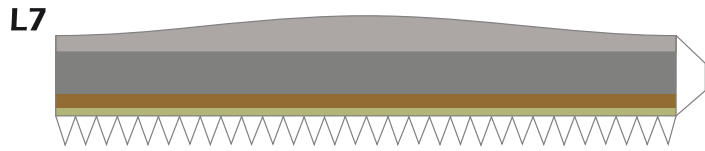
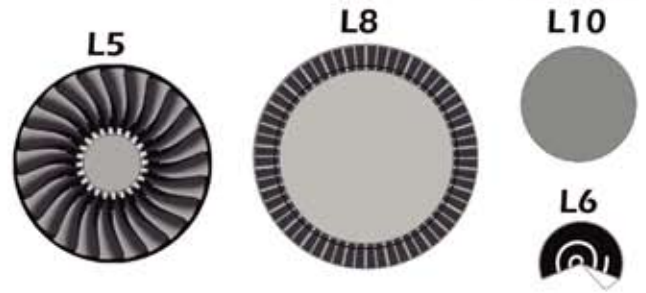
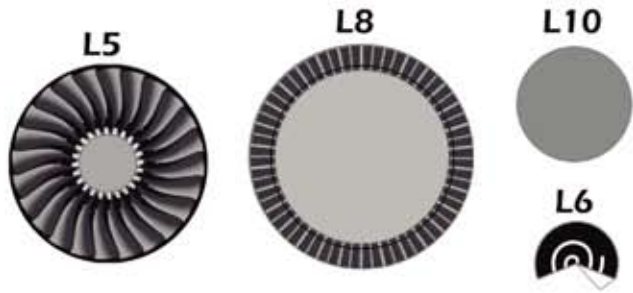

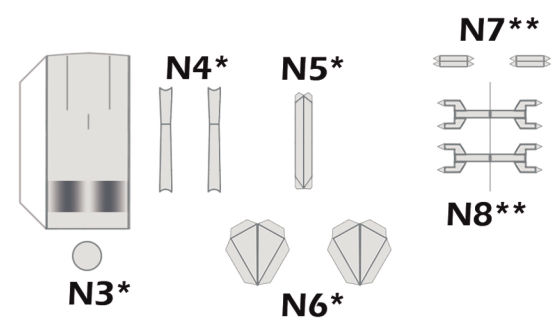
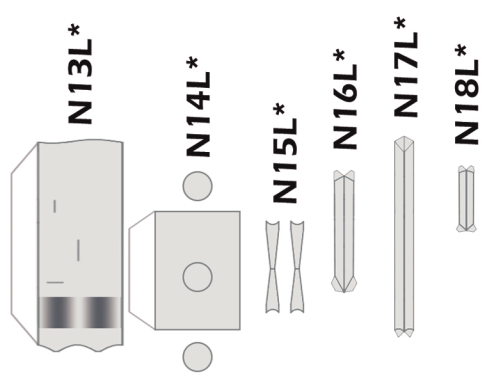
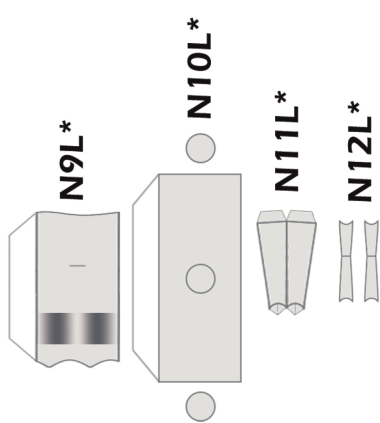
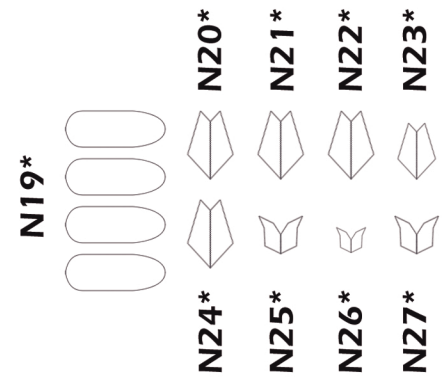
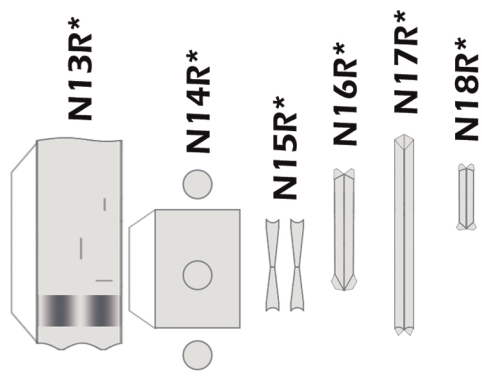
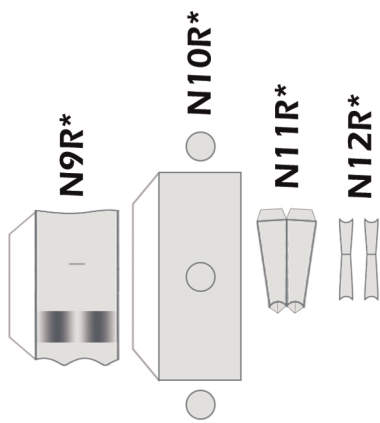
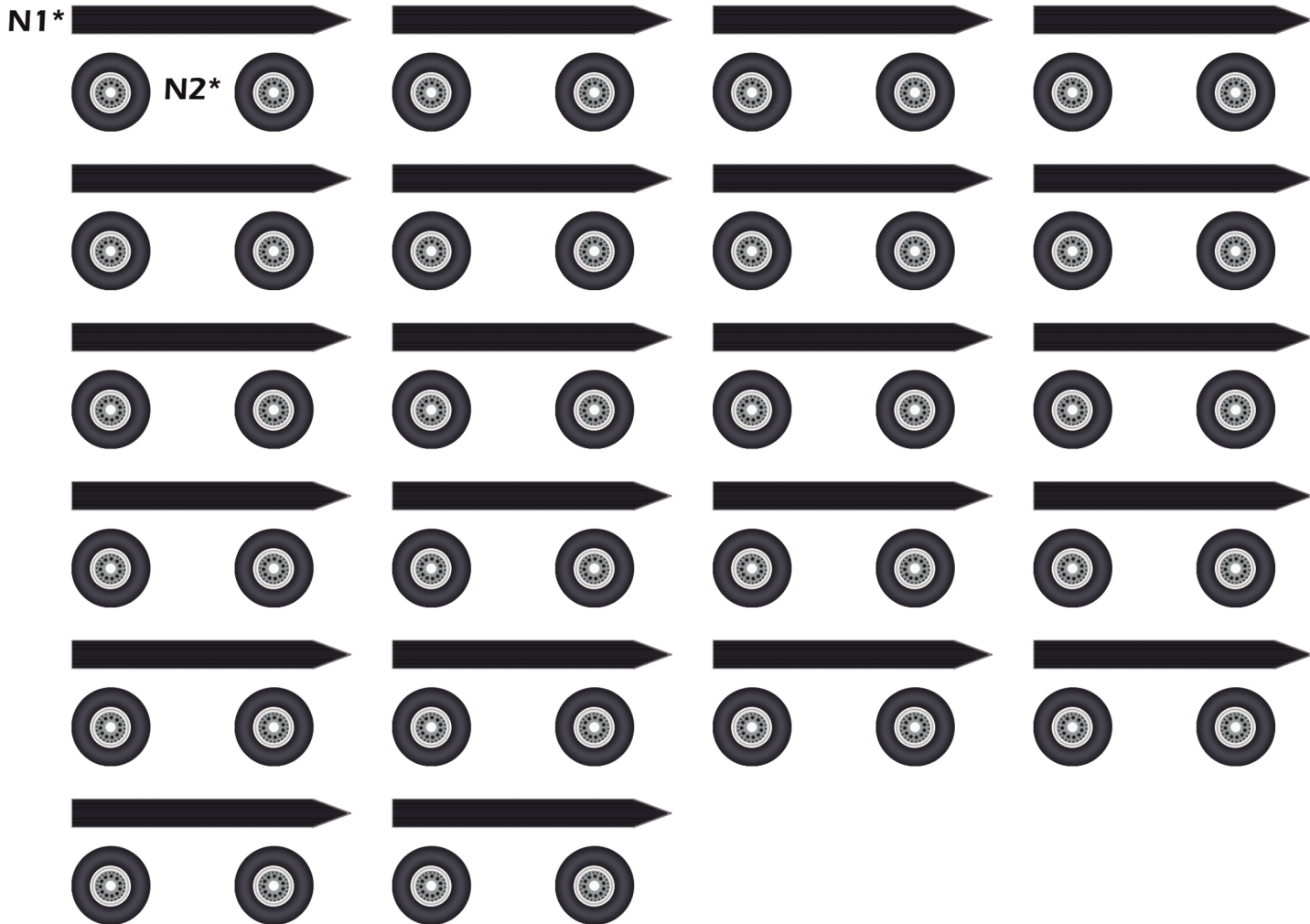

O3L

O1

O2R

HERMERCRAFT

DESIGNED BY EDWIN RODRIGUEZ

O3R

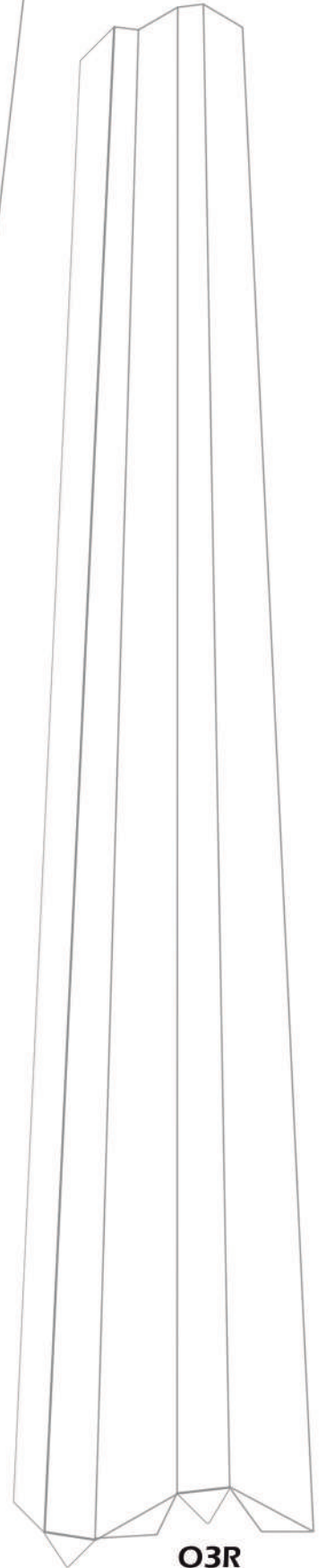
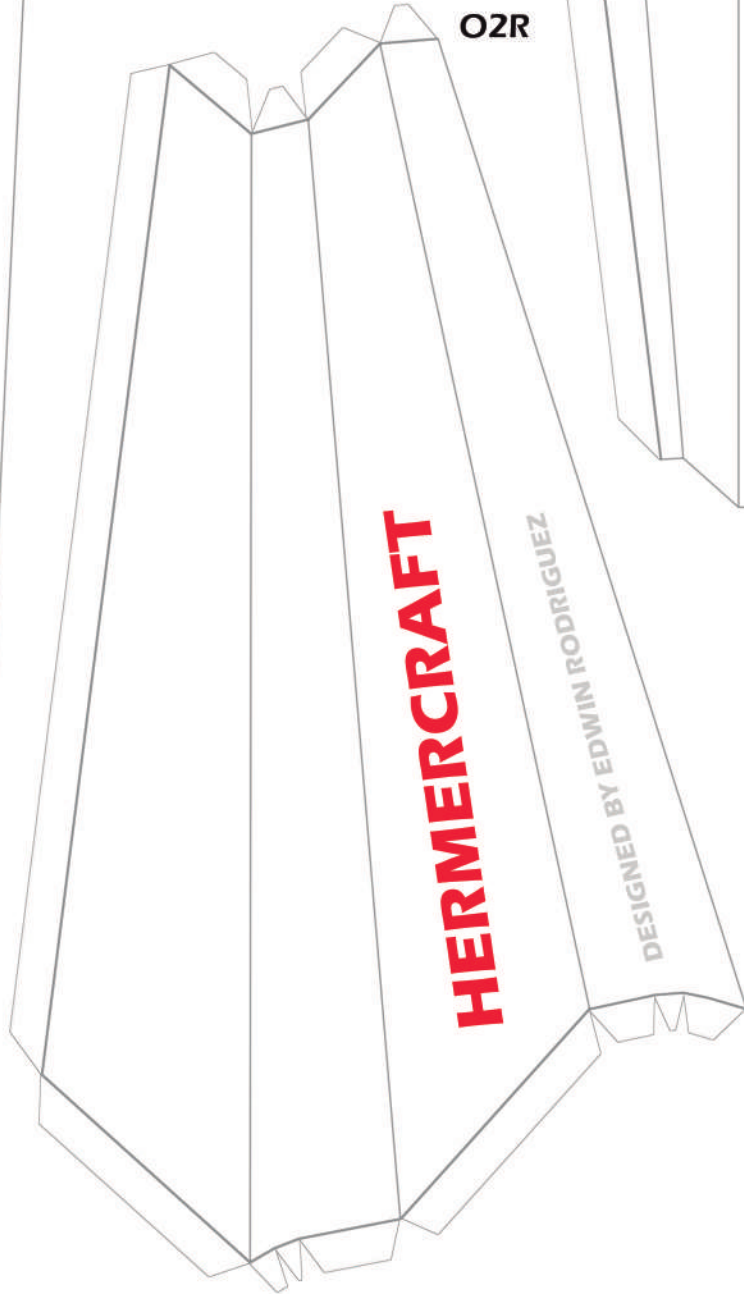
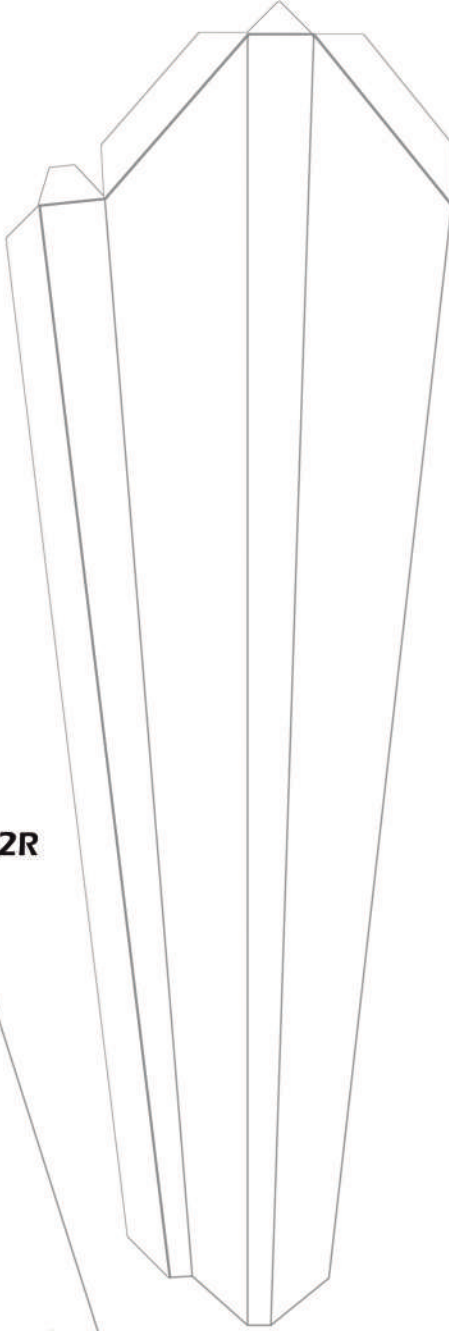
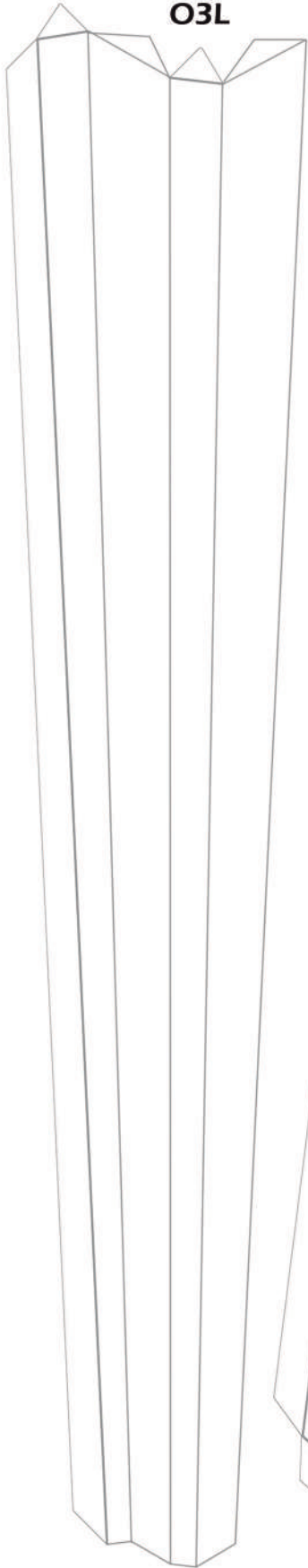

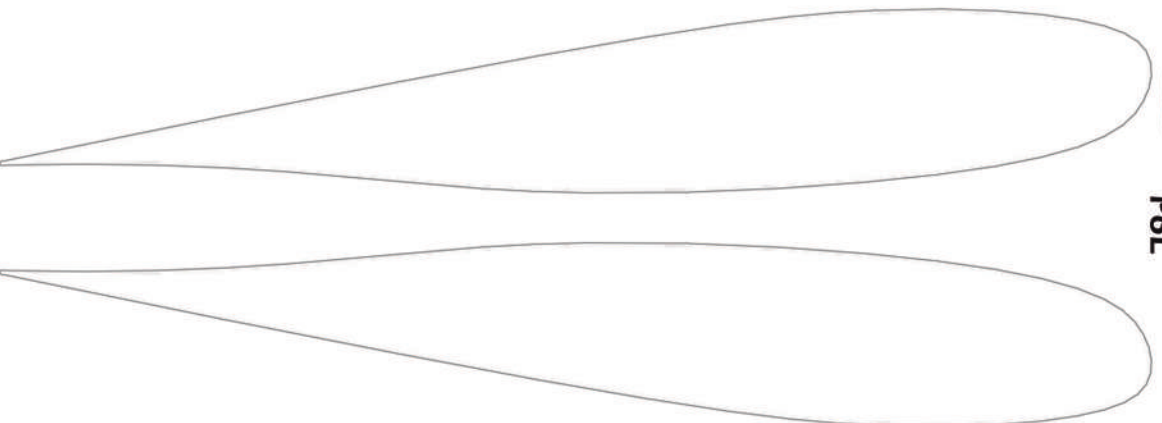
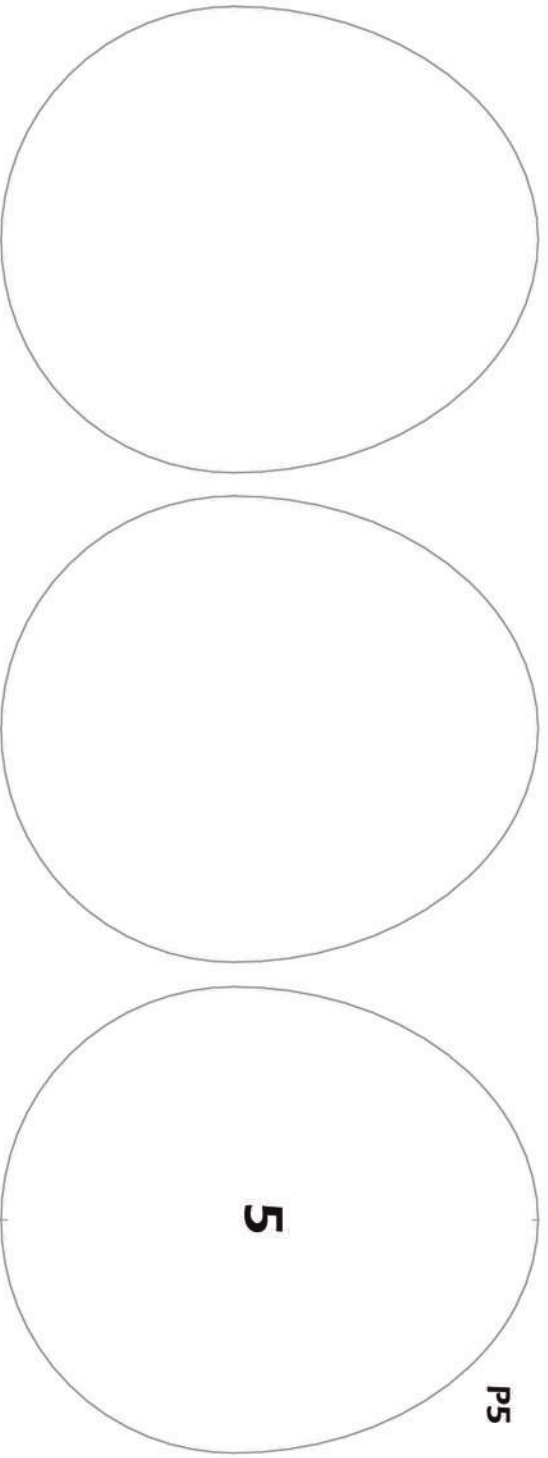
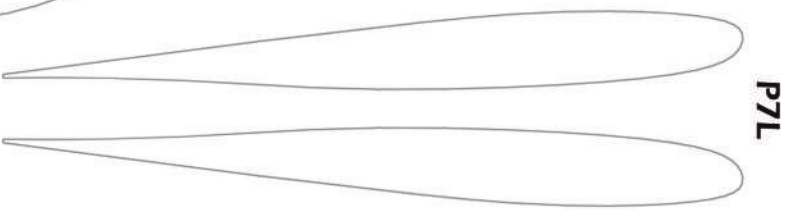
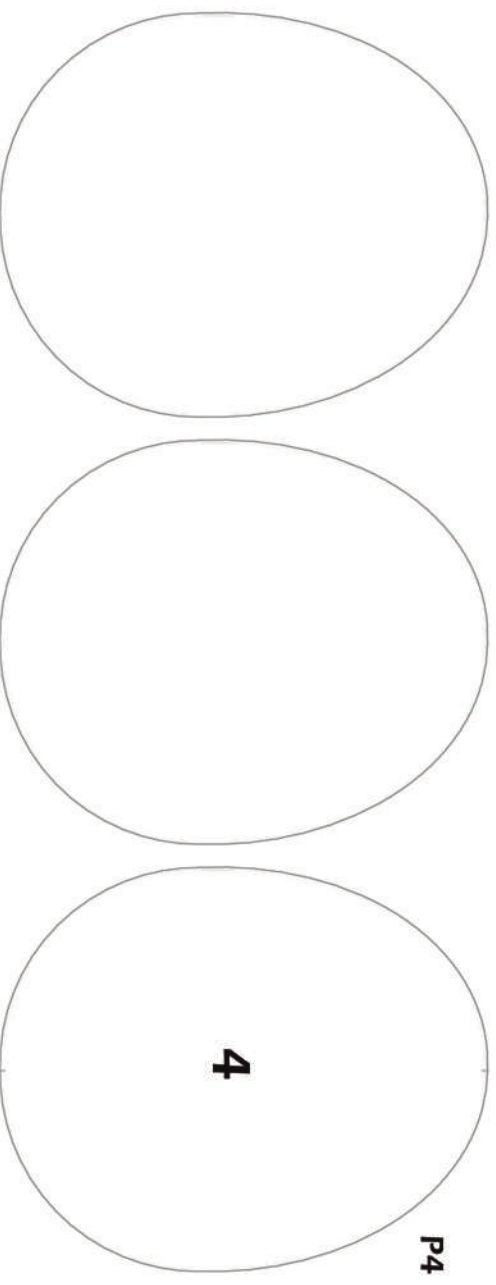
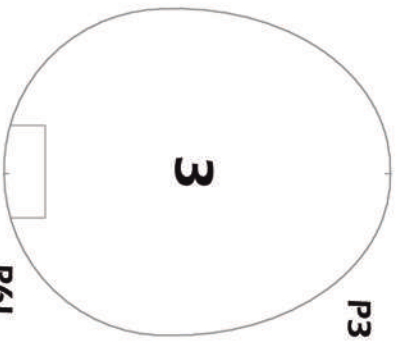
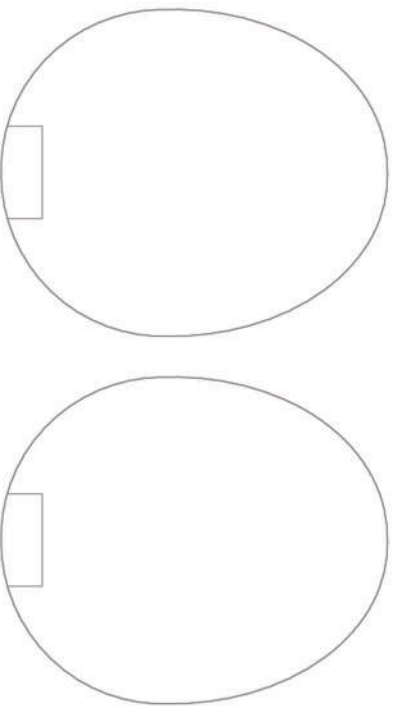
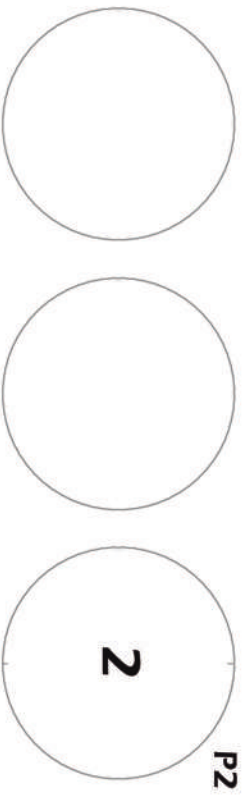
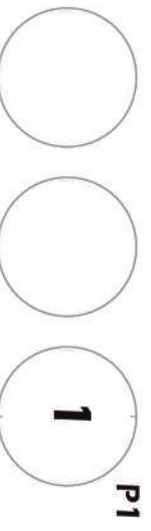

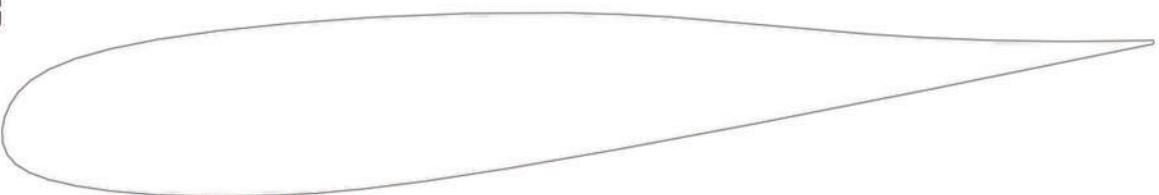
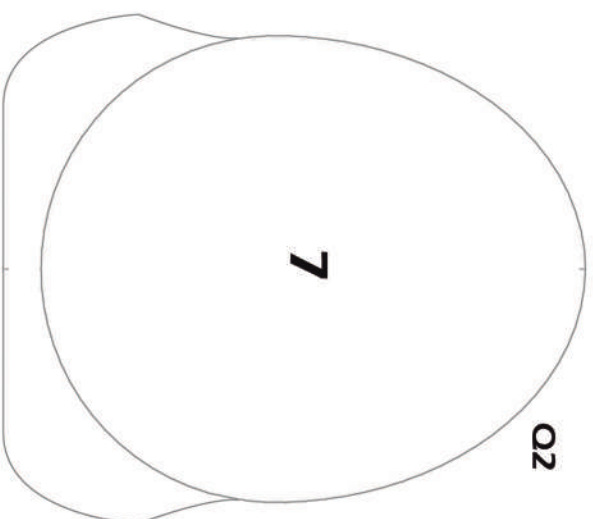
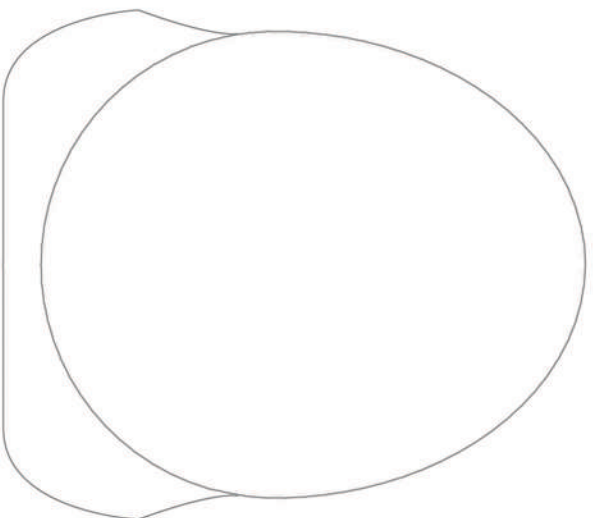
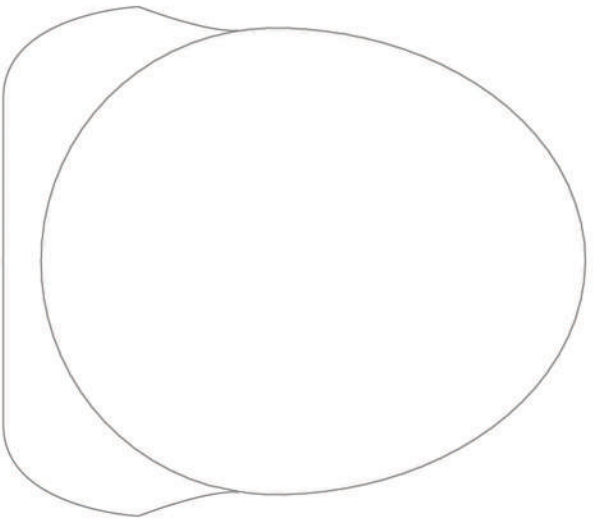
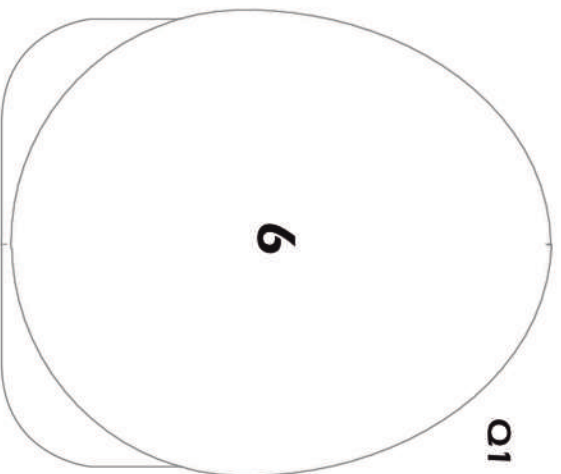
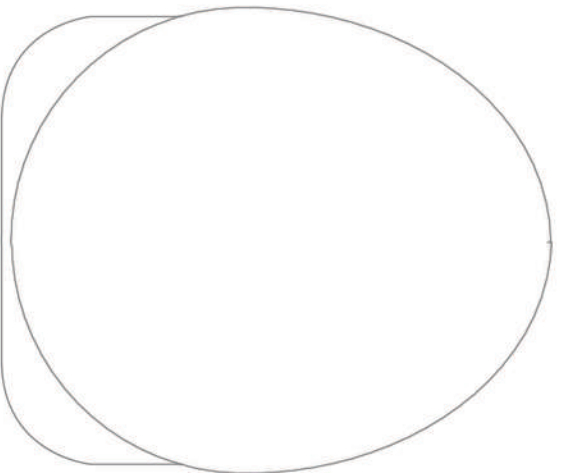
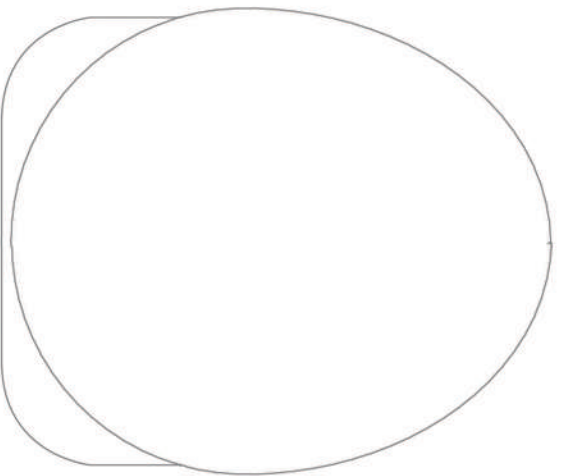

Q5R

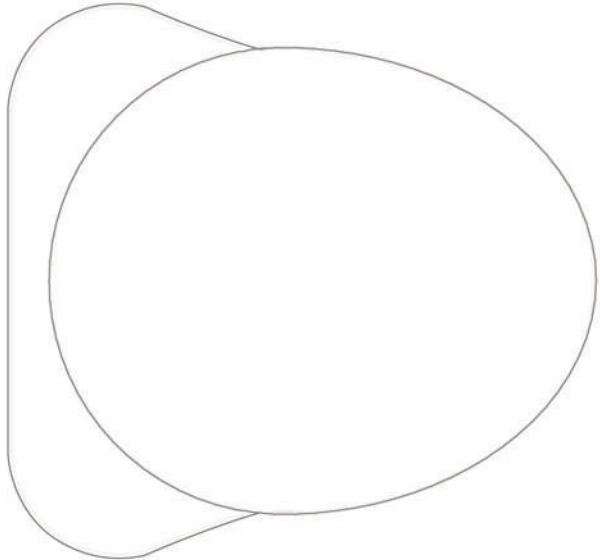

R1

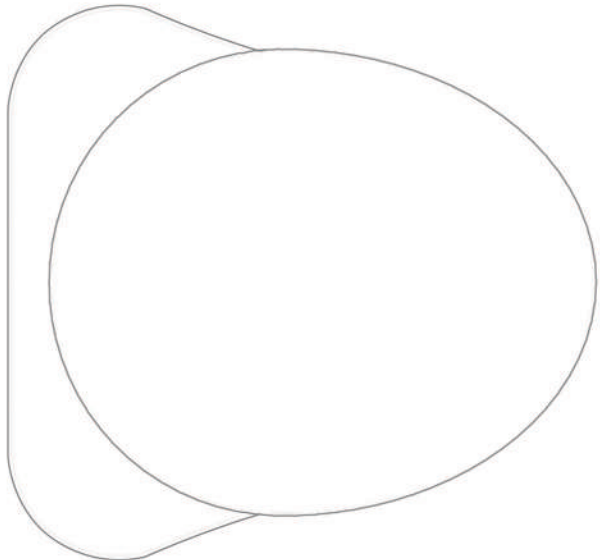

R2

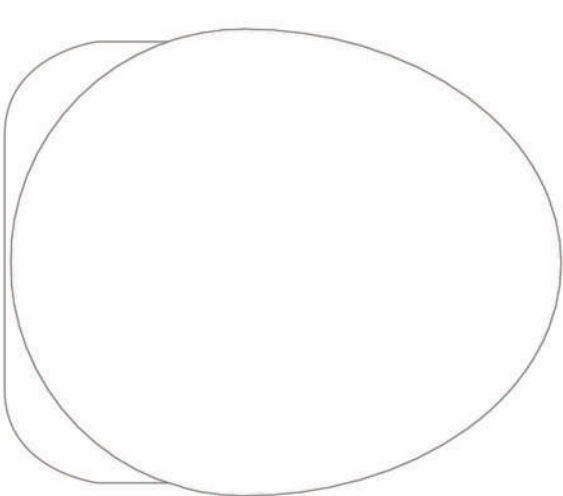

9

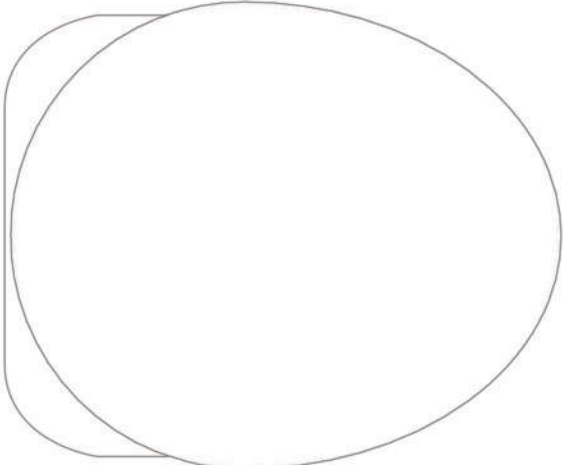

R4

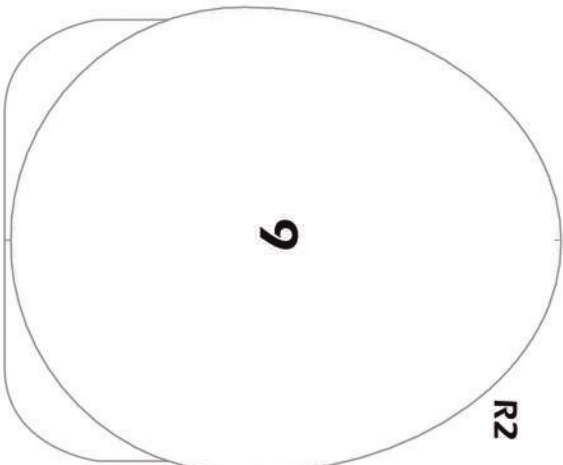

8

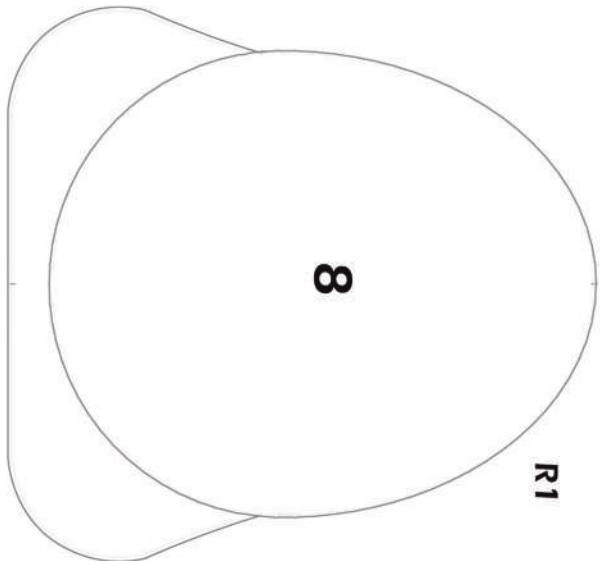

R5L

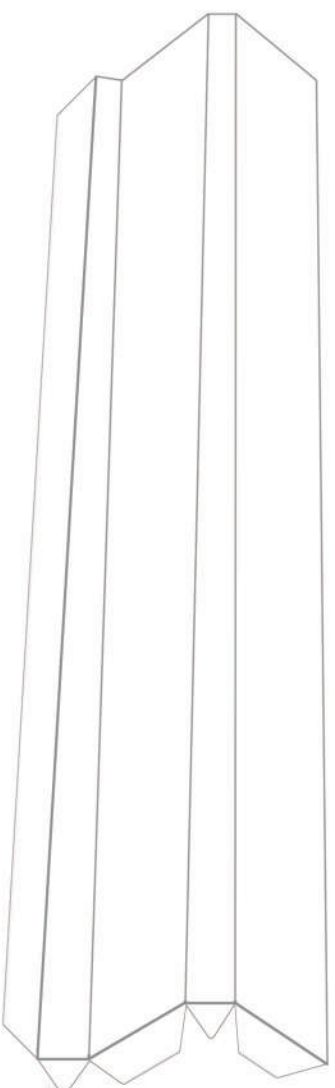

R5R

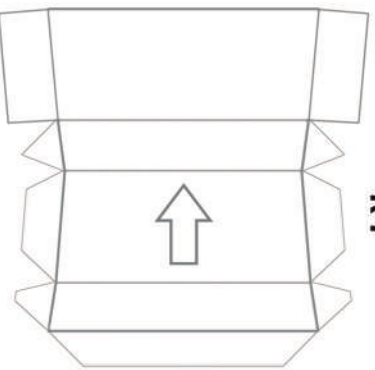

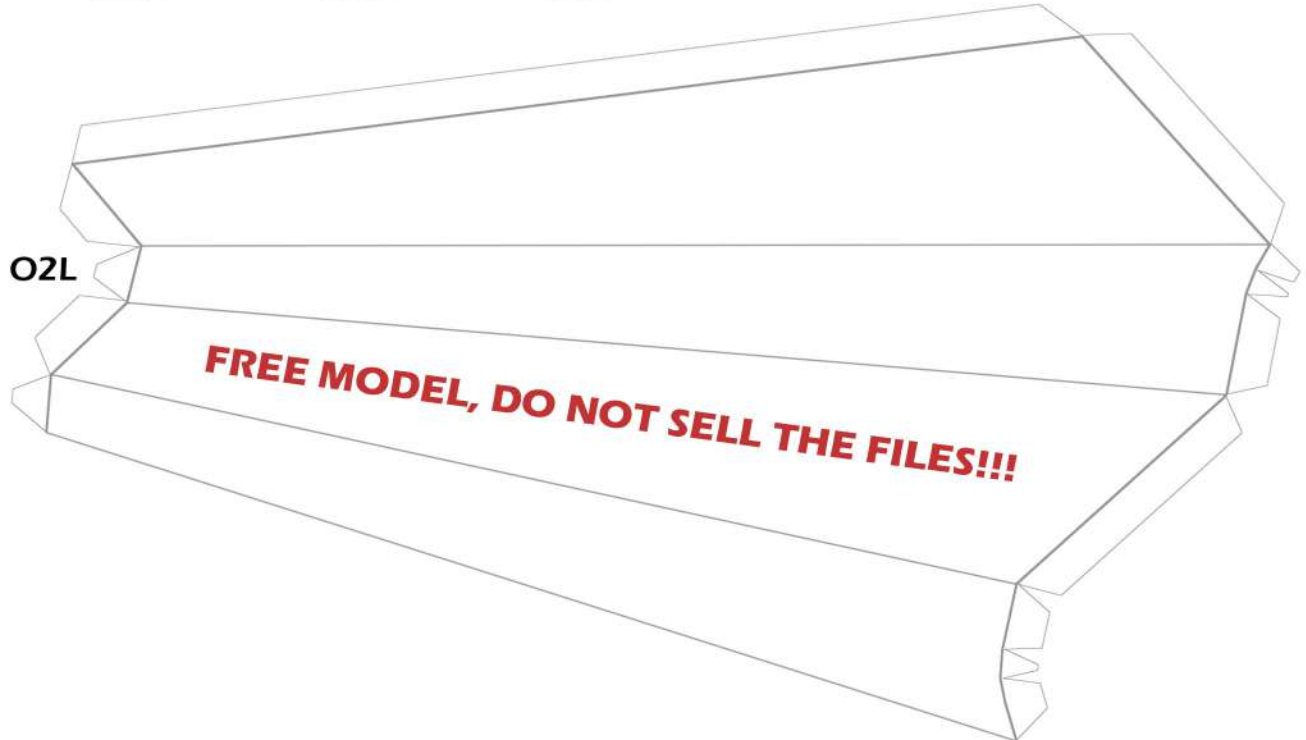
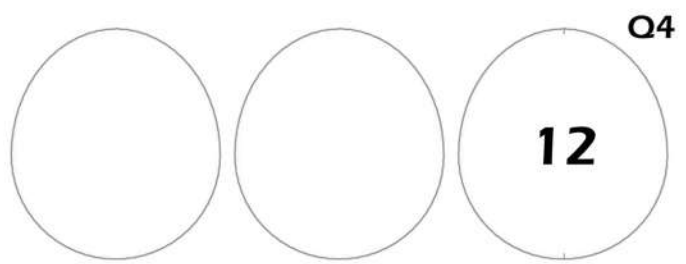
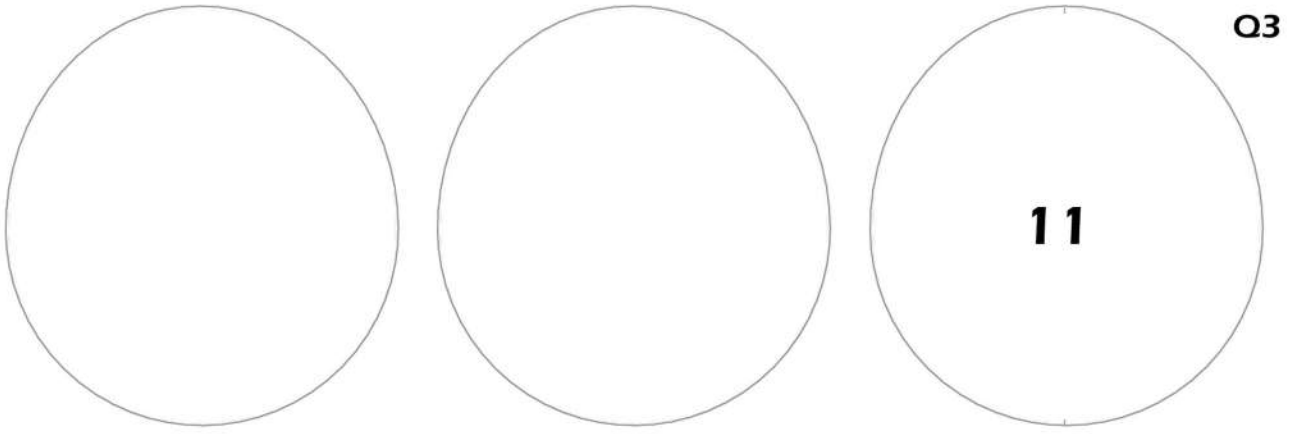
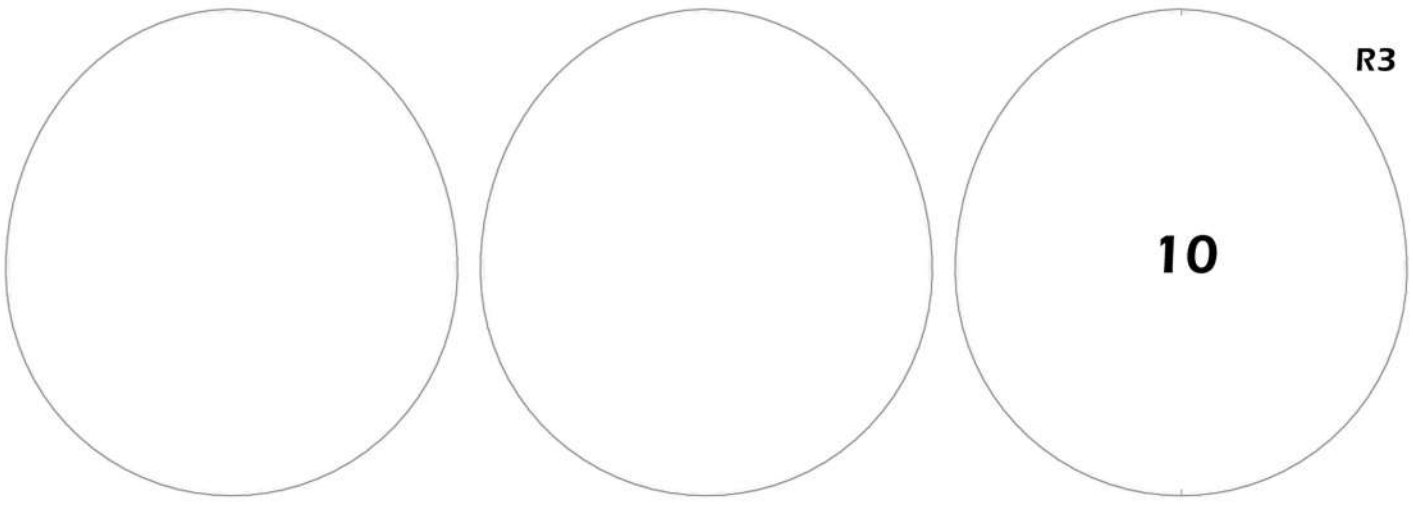

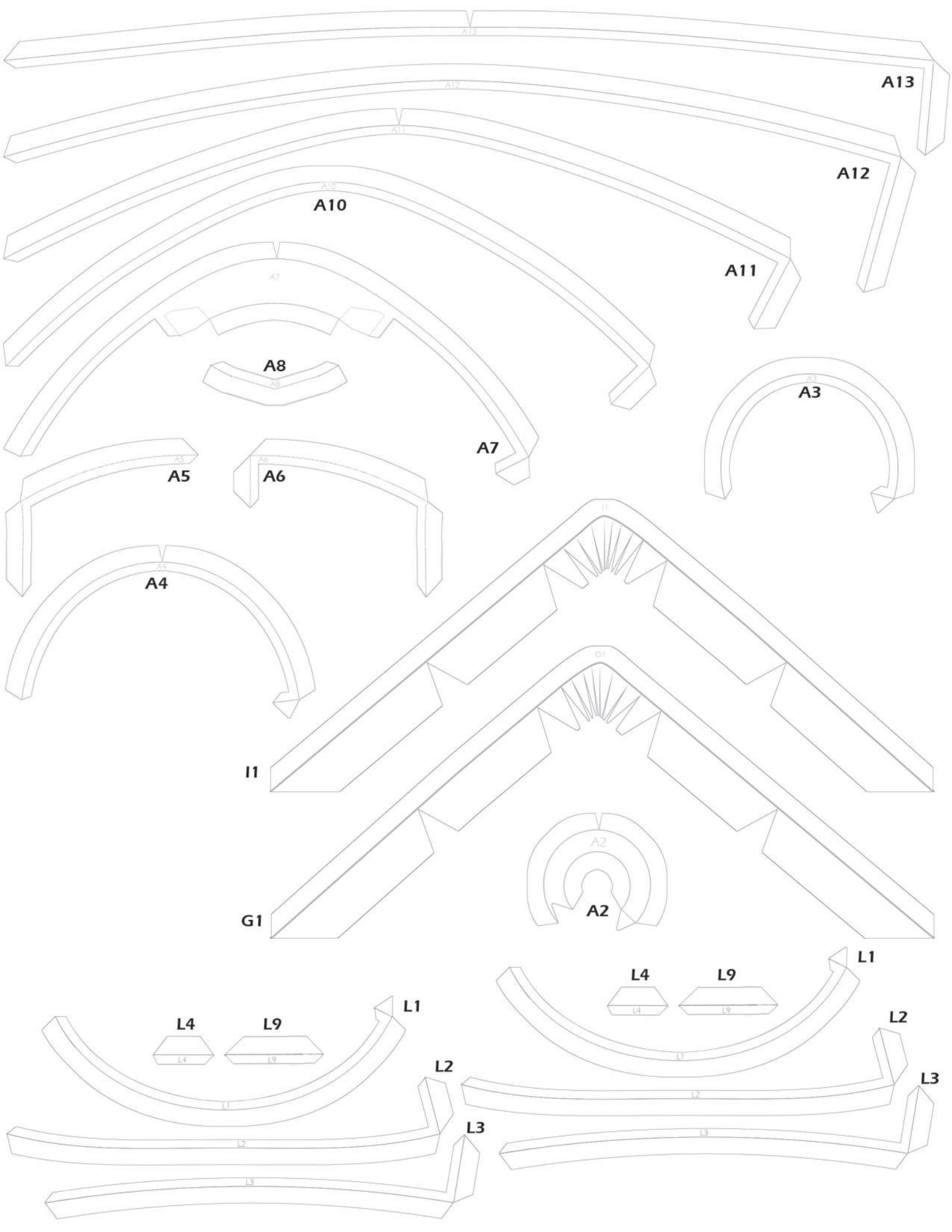

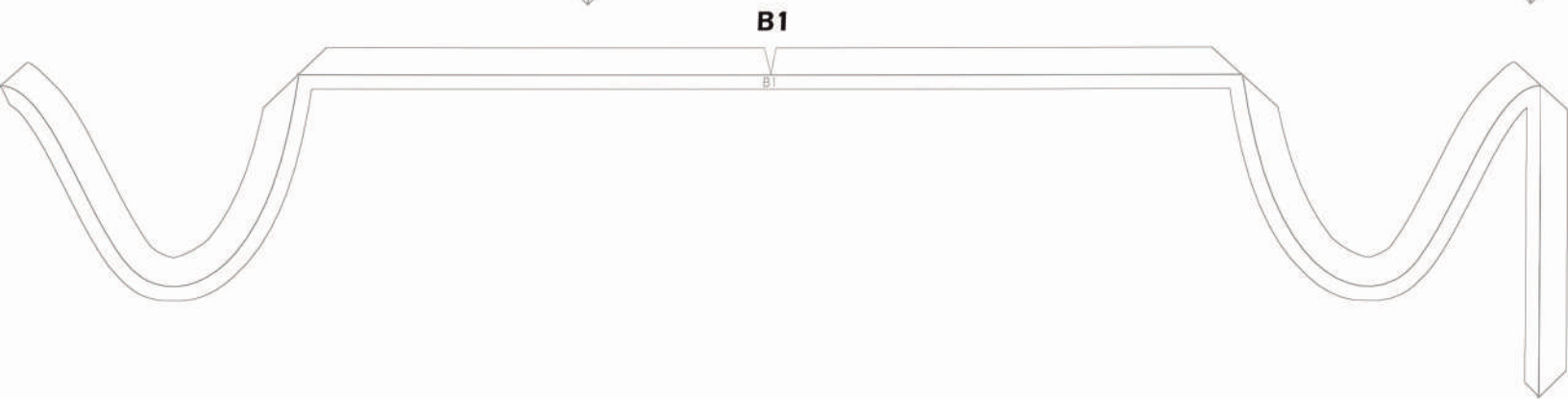
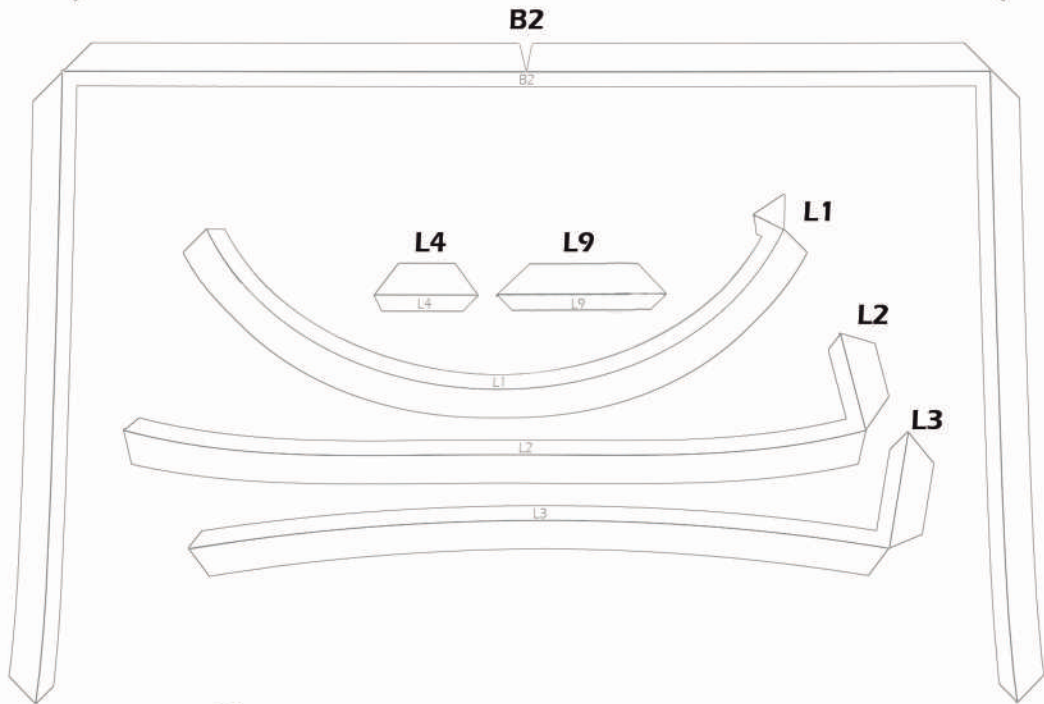
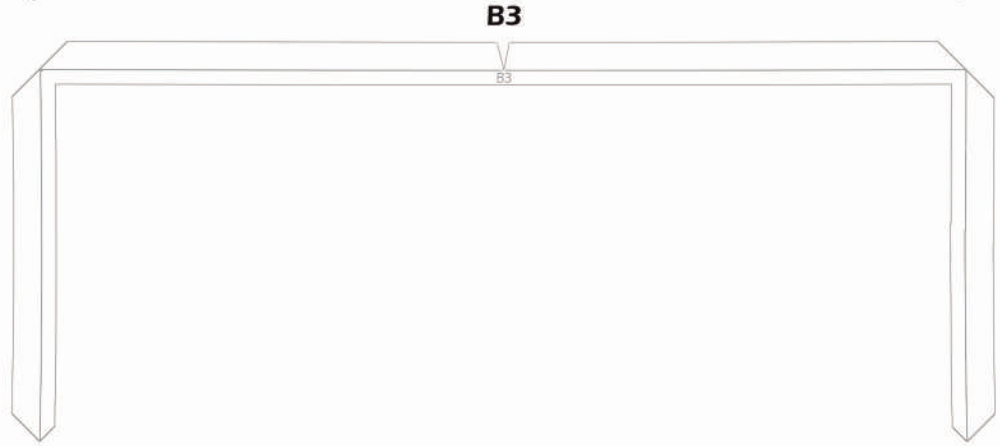
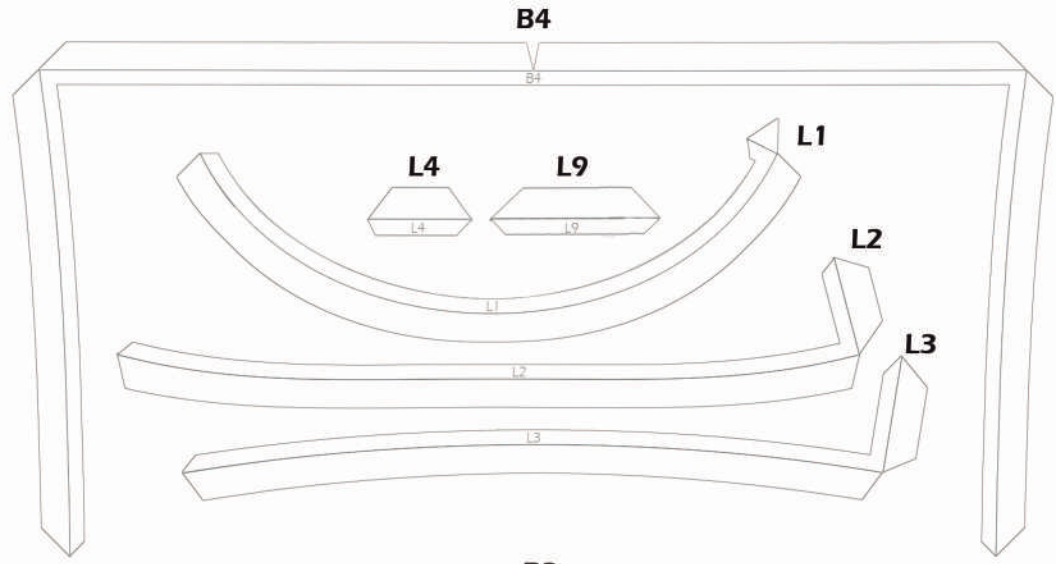
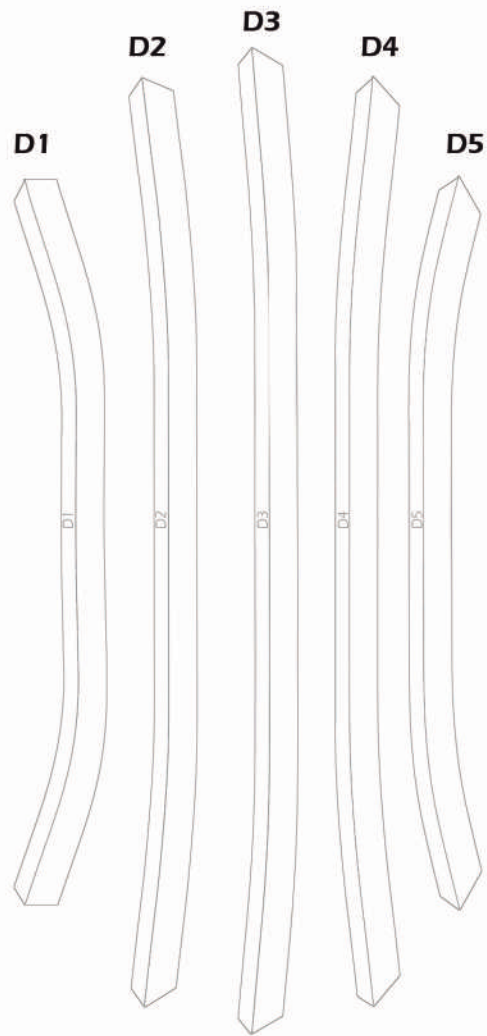

K15L K16L

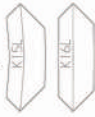

K11L K12L



K7L K8L



K4L K5L



K1L K2L



K1R K2R



K4R K5R



K7R K8R

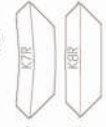

K11R K12R



K15R K16R



C7

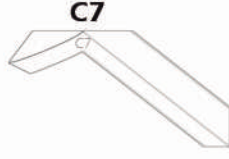

C6

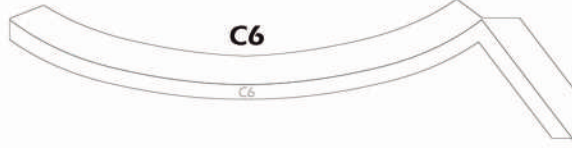

C5

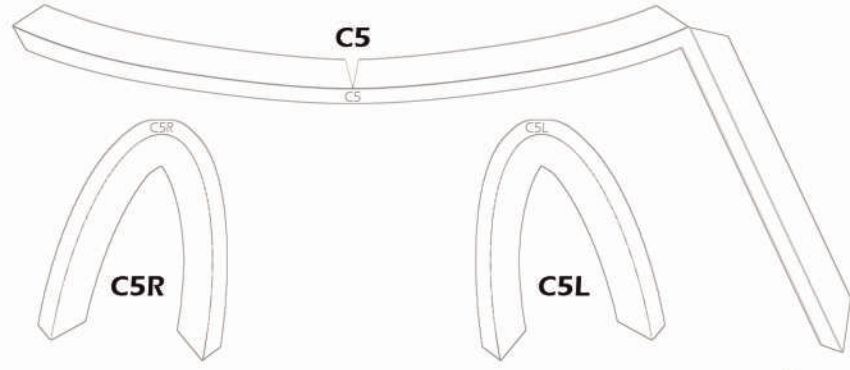

C5R

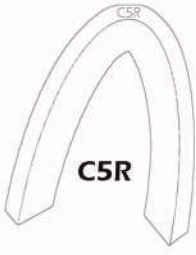

C5L



C4

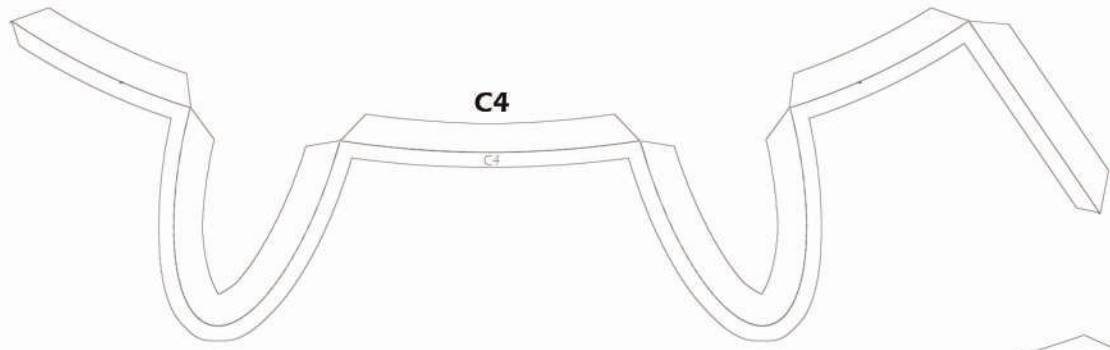

C3

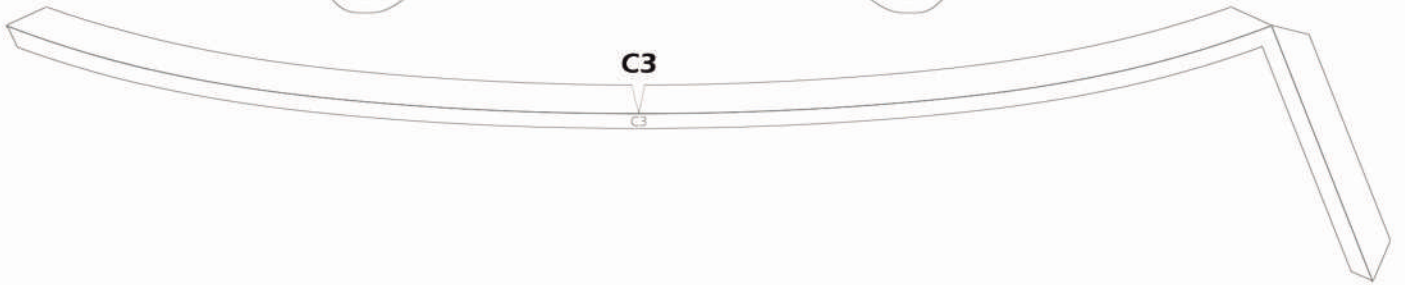

C2

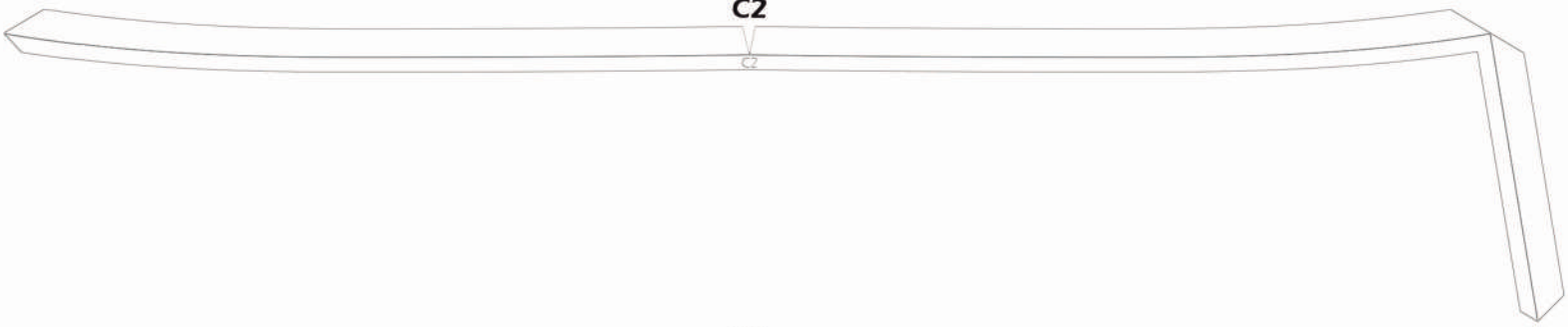

C1

