

BOEING B777-300ER EVA AIR

HERMERCRAFT

Repainted by: Christopher Roden

© 2020 Edwin Rodriguez

A13*

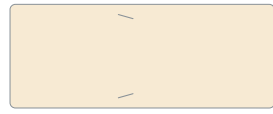
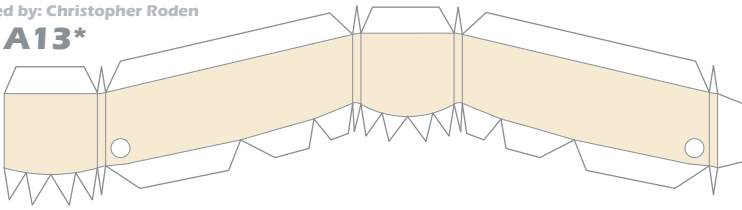

A14*



A21



A22



A23



A24

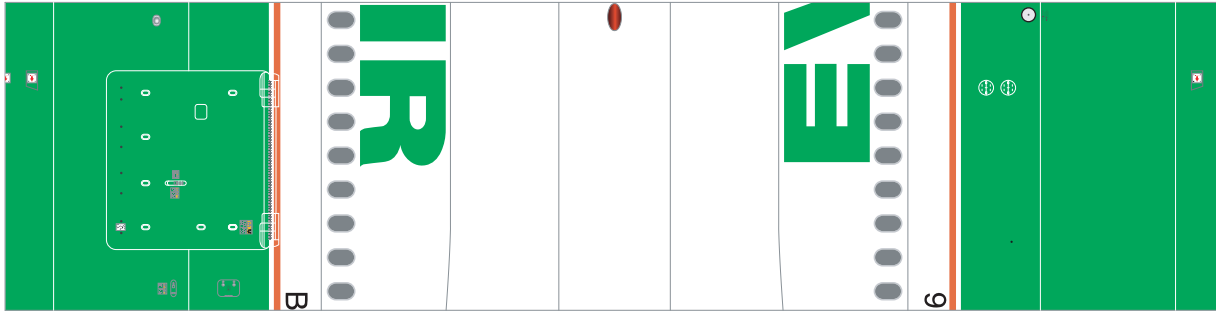

A12

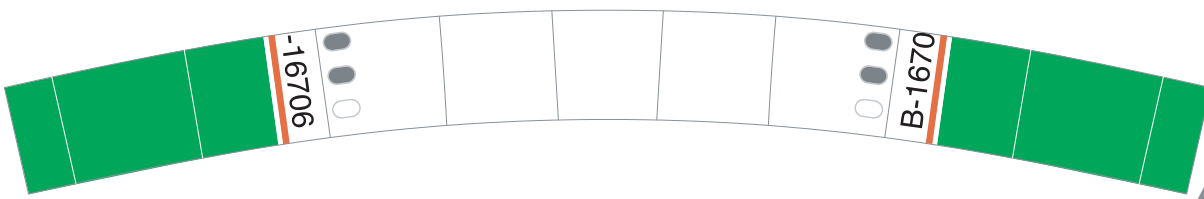

A11

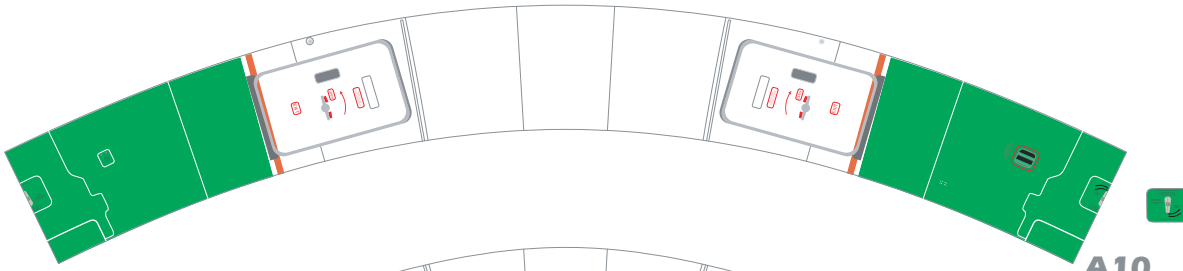

A10

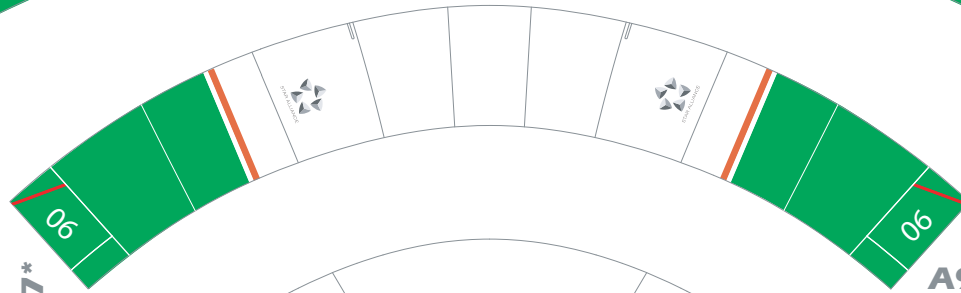

A9



A25*



A27*



A26*

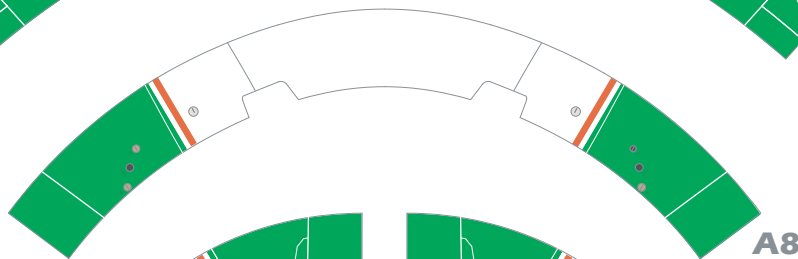

A8

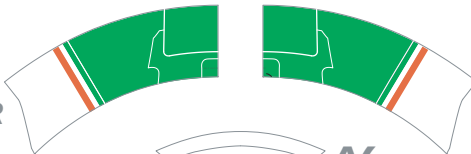

A7R

A7L

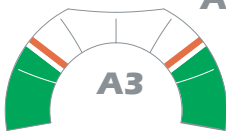

A3



A2



A1



A6

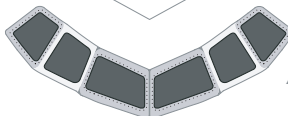

A5



A4

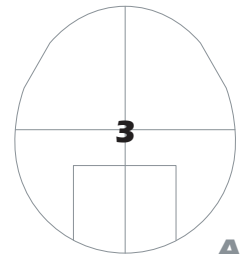
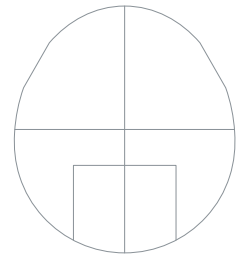
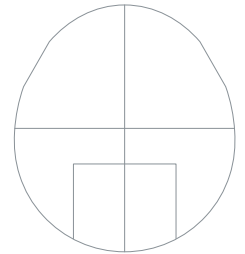

A17



2

A16



1

A15

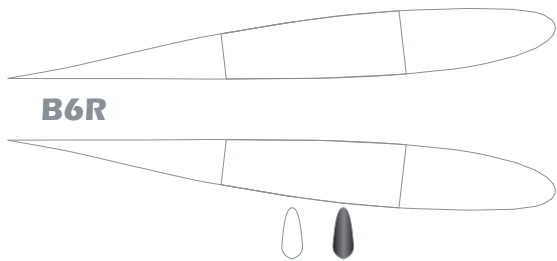

B6R

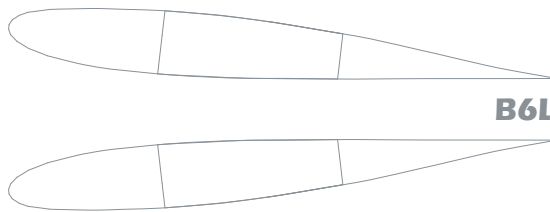

B6L

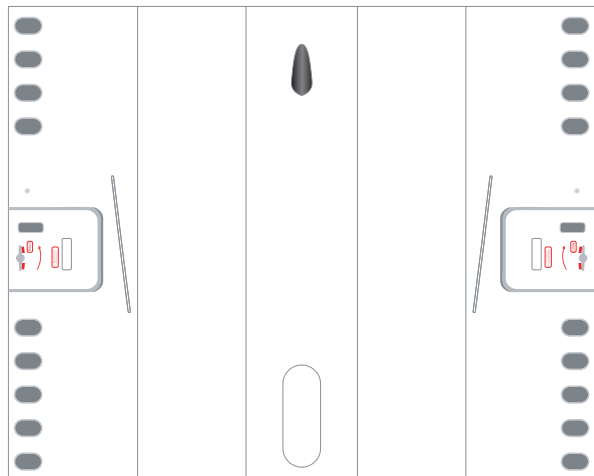

B3

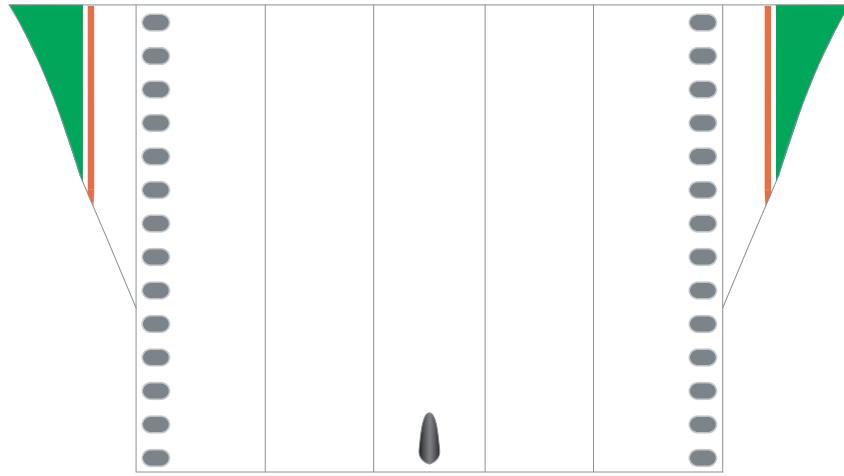

B4

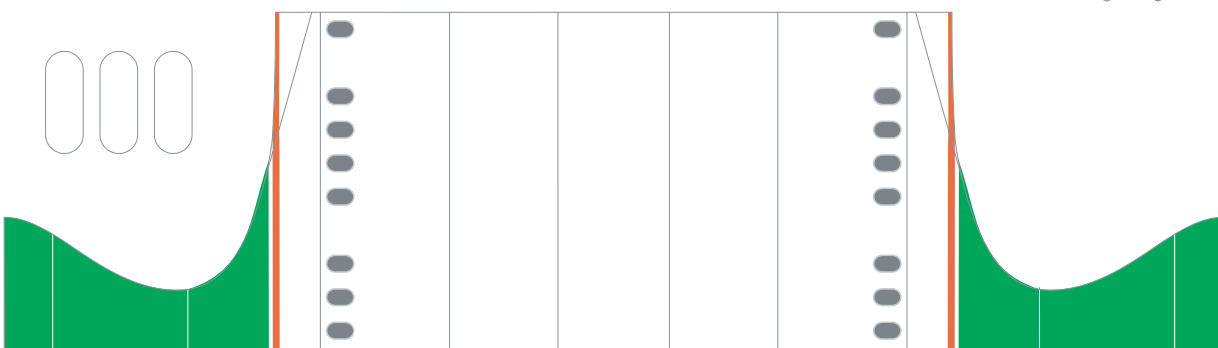

B2

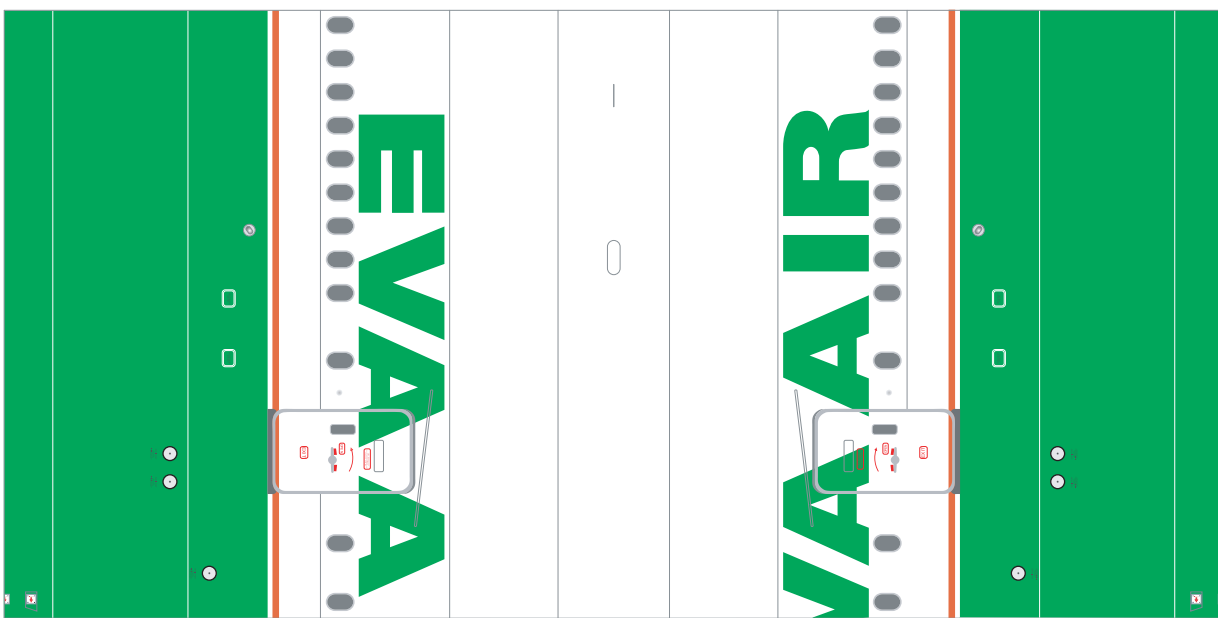

B1



B5

BOEING B777-300ER EVA AIR

HERMERCRAFT

Repainted by: Christopher Roden

© 2020 Edwin Rodriguez

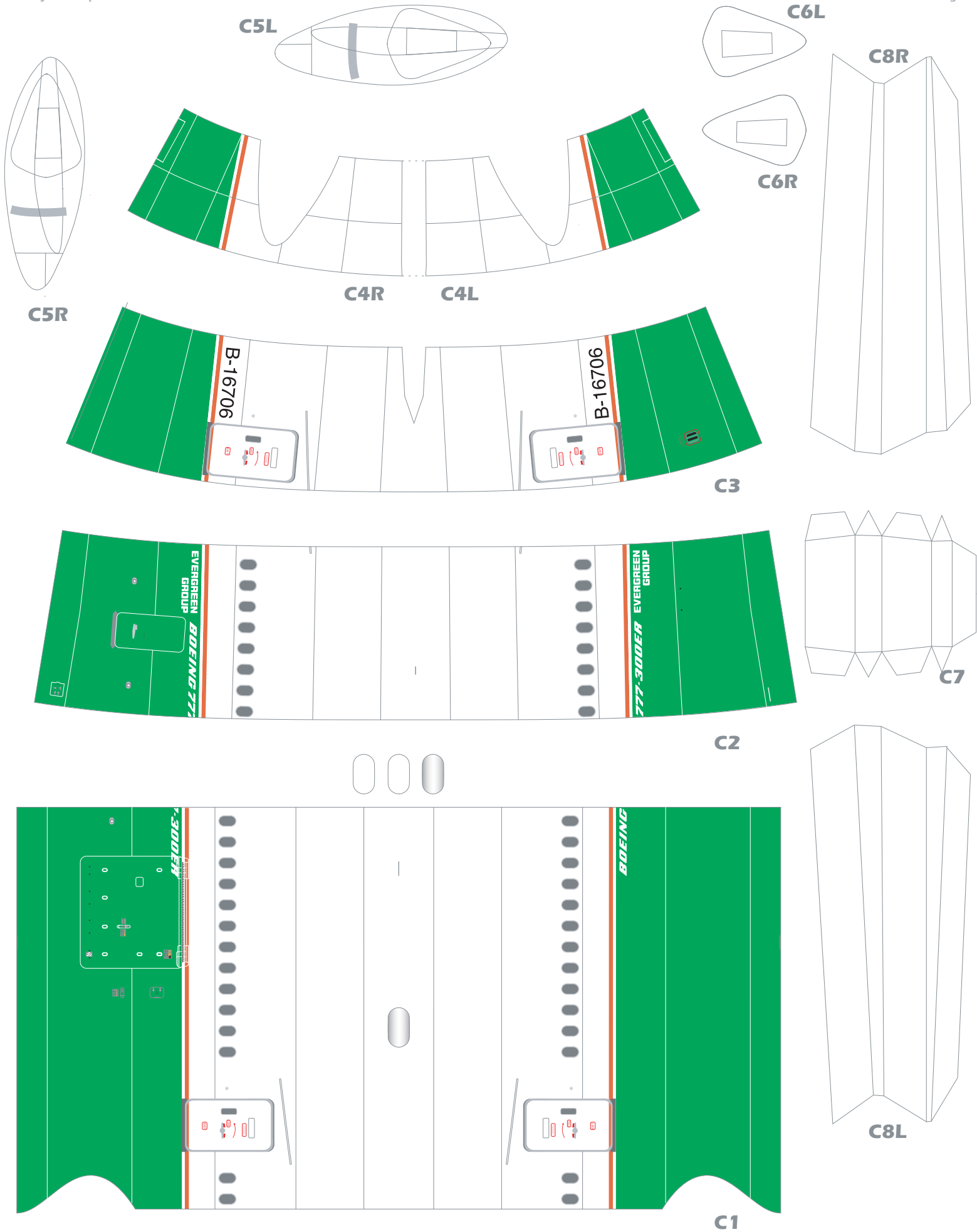

D14R* D14L*

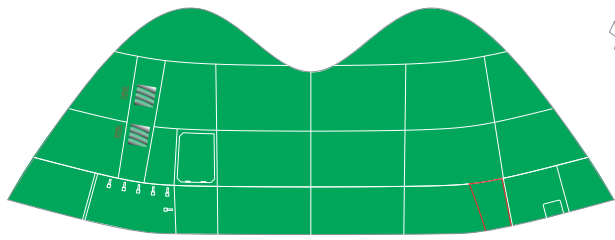

D5

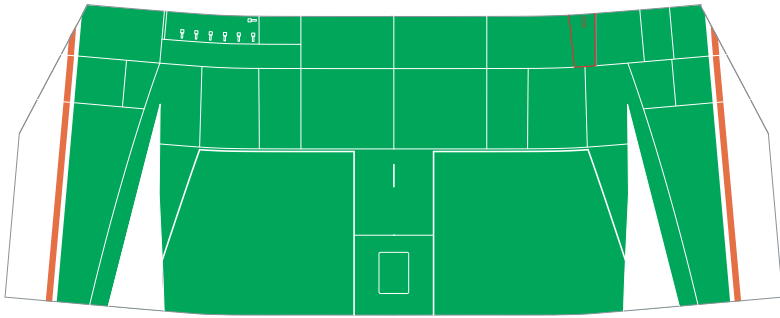

D4

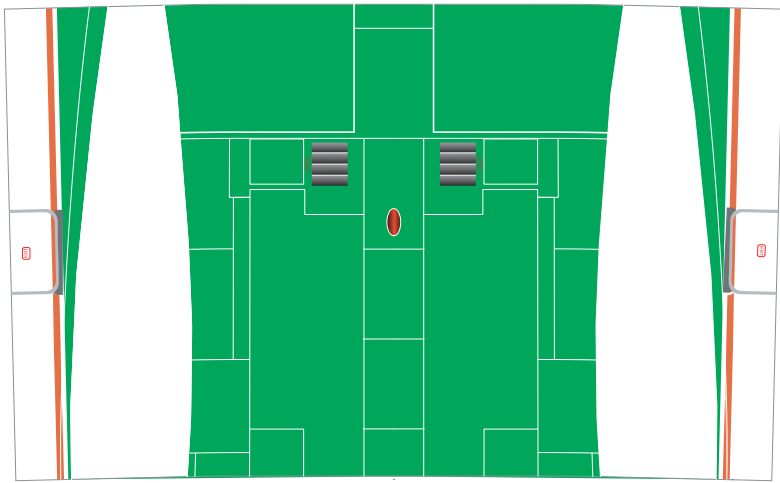

D3



D2

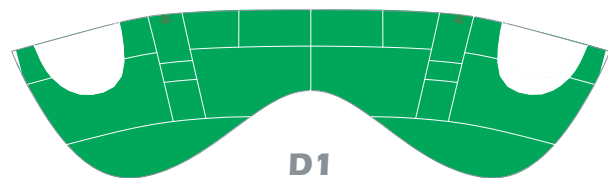

D1

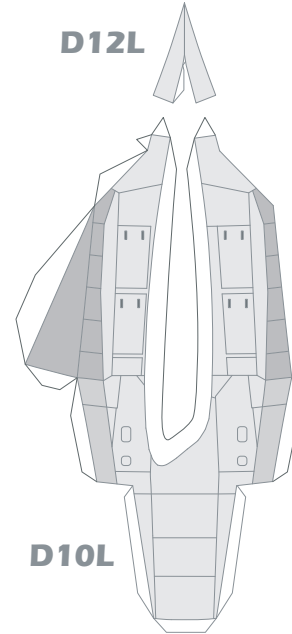

D12L

D10L

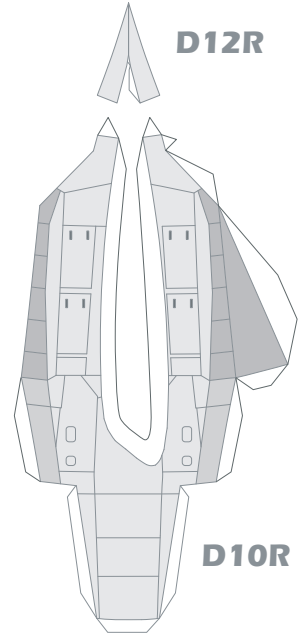

D12R

D10R



D11L



D11R

D12*



D13*

D9

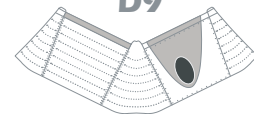

D8

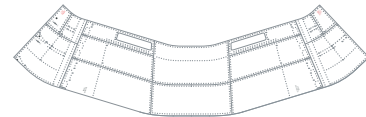

D15*

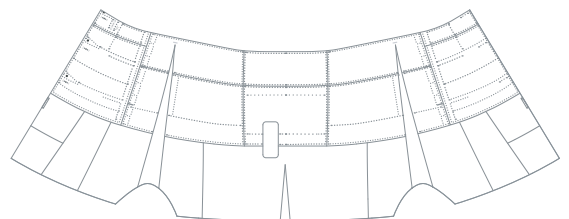

D7



D6L



D6CL



D6CR



D6R

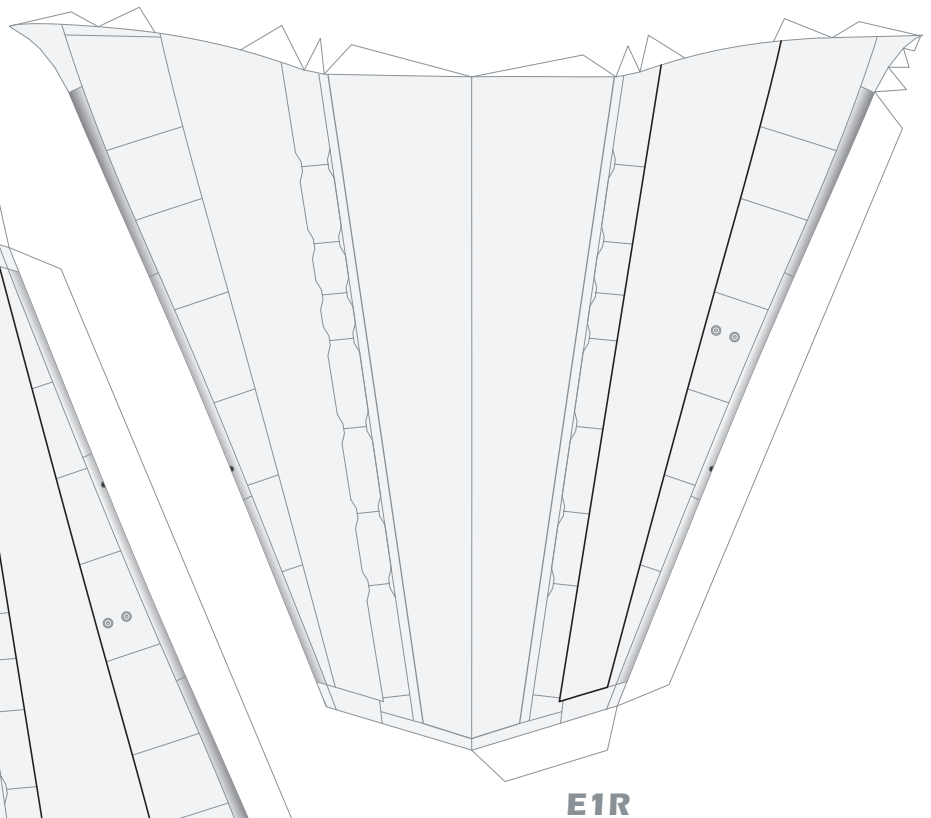
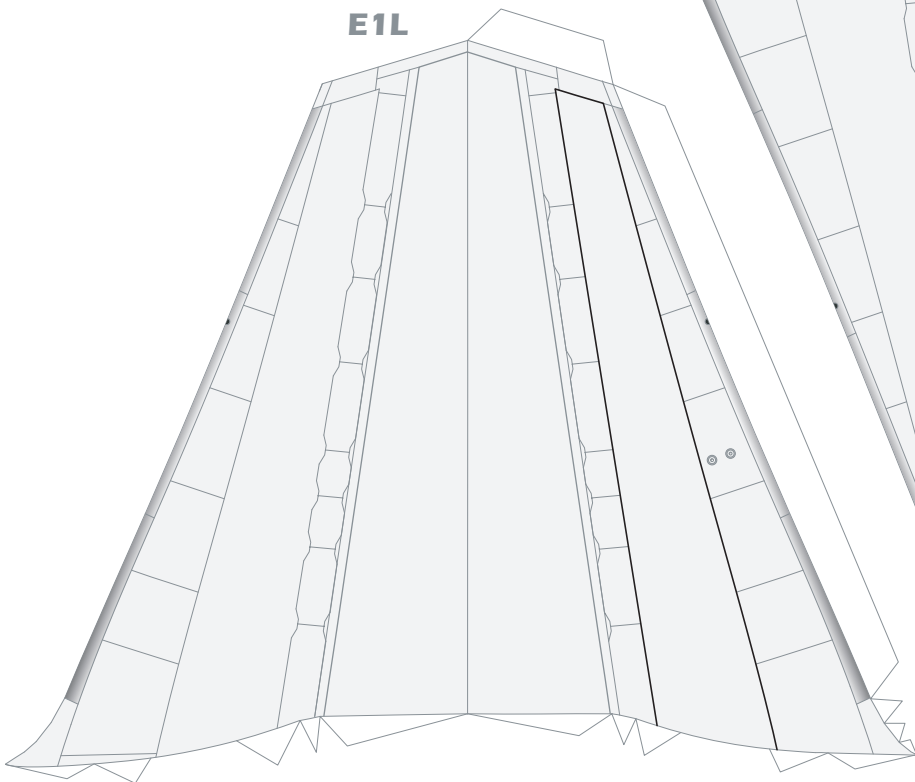
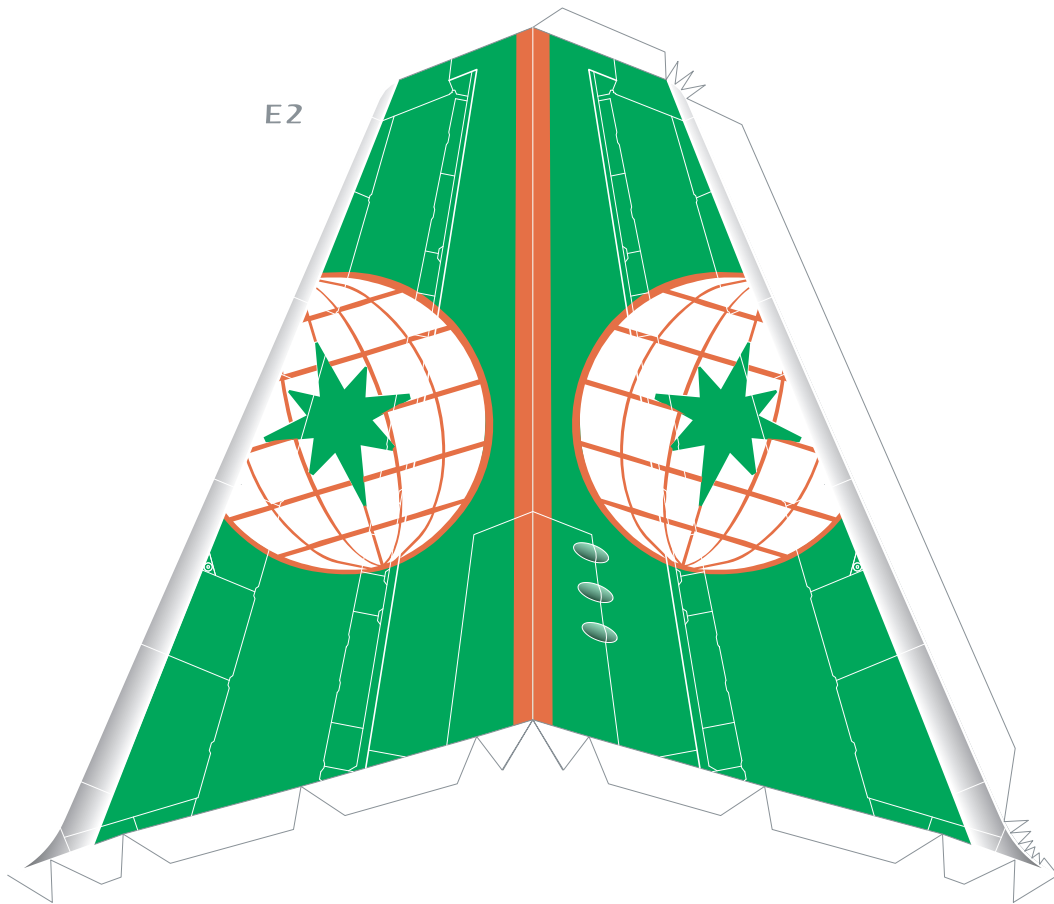

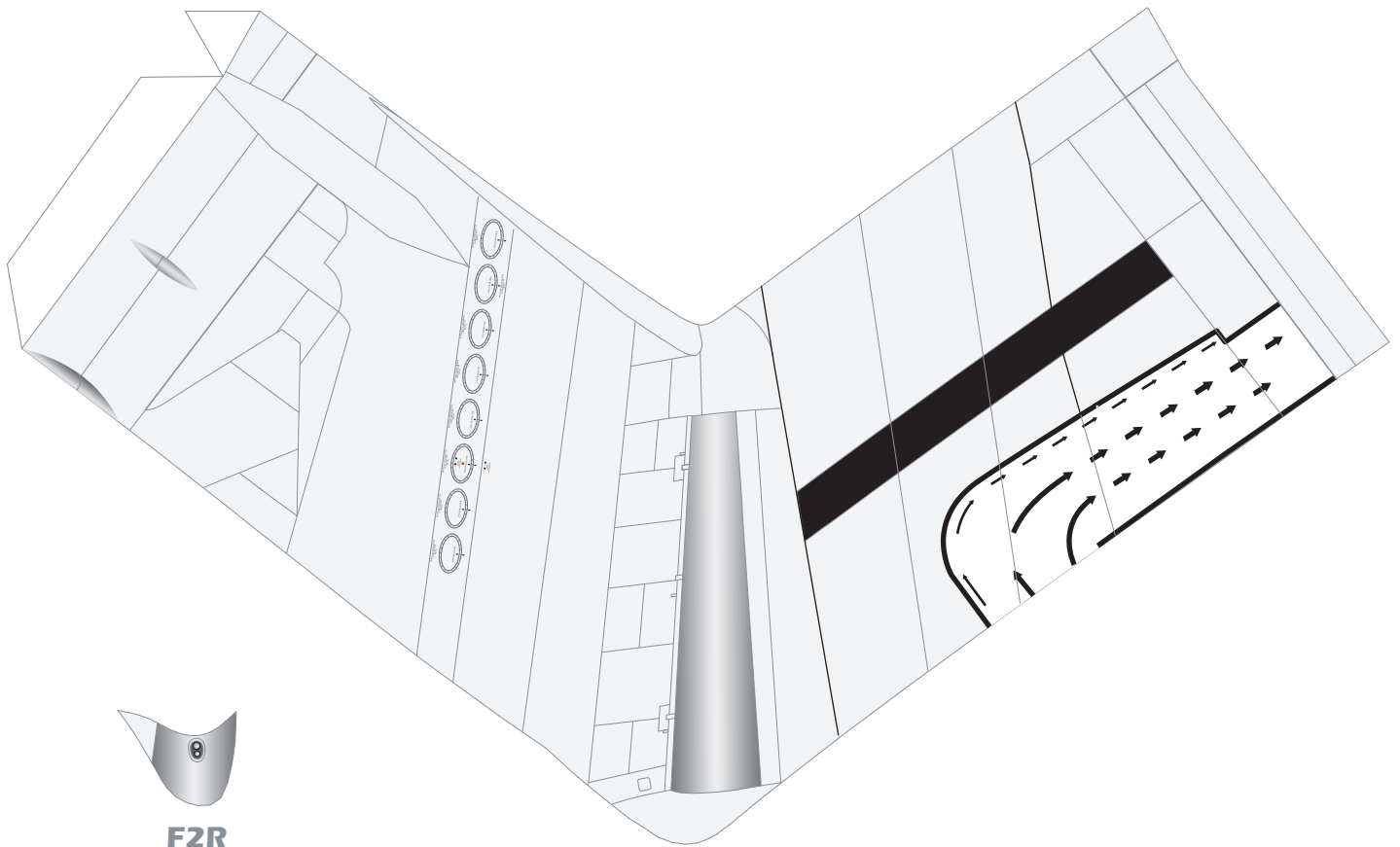

F2R

F1R

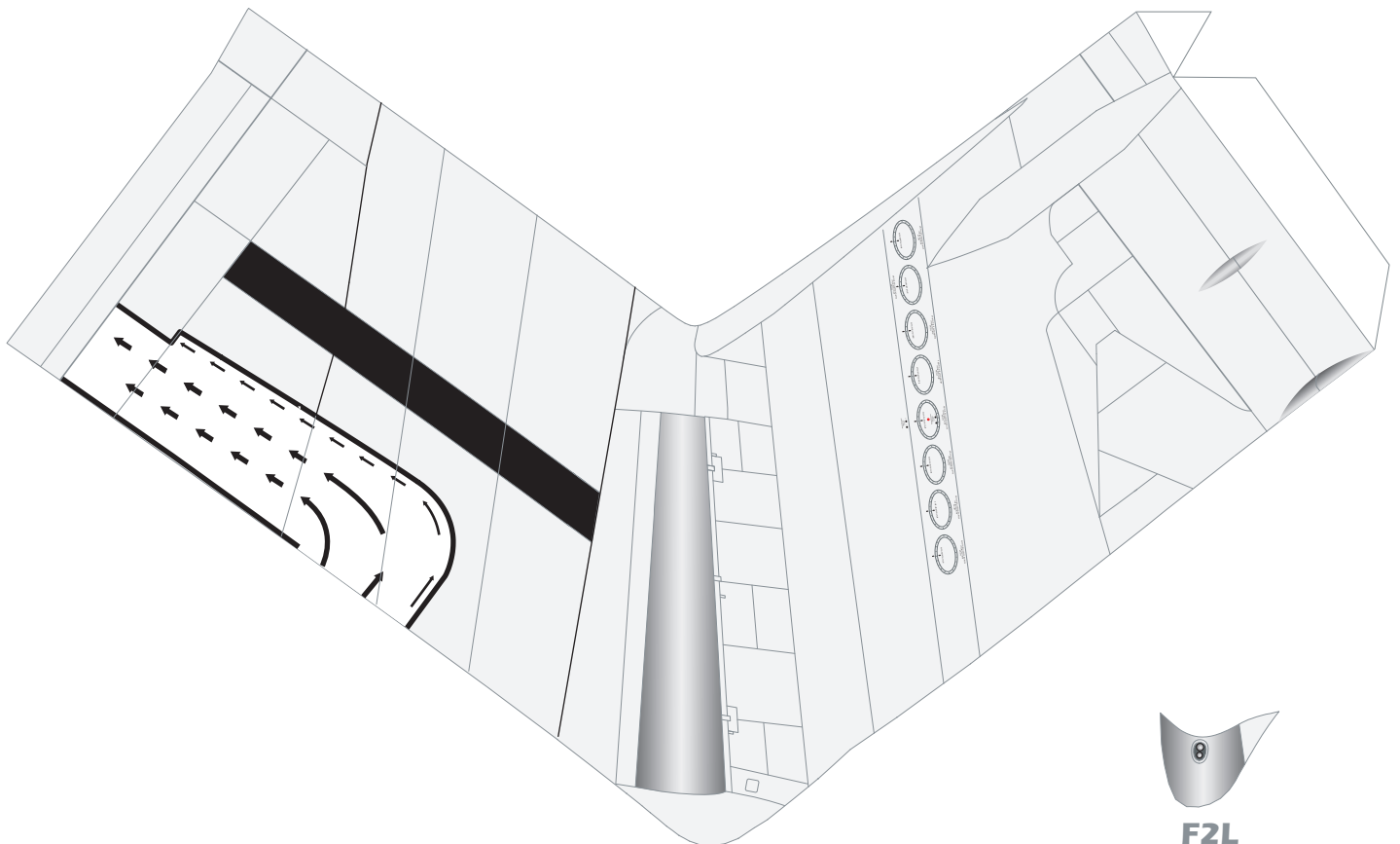

F2L

F1L

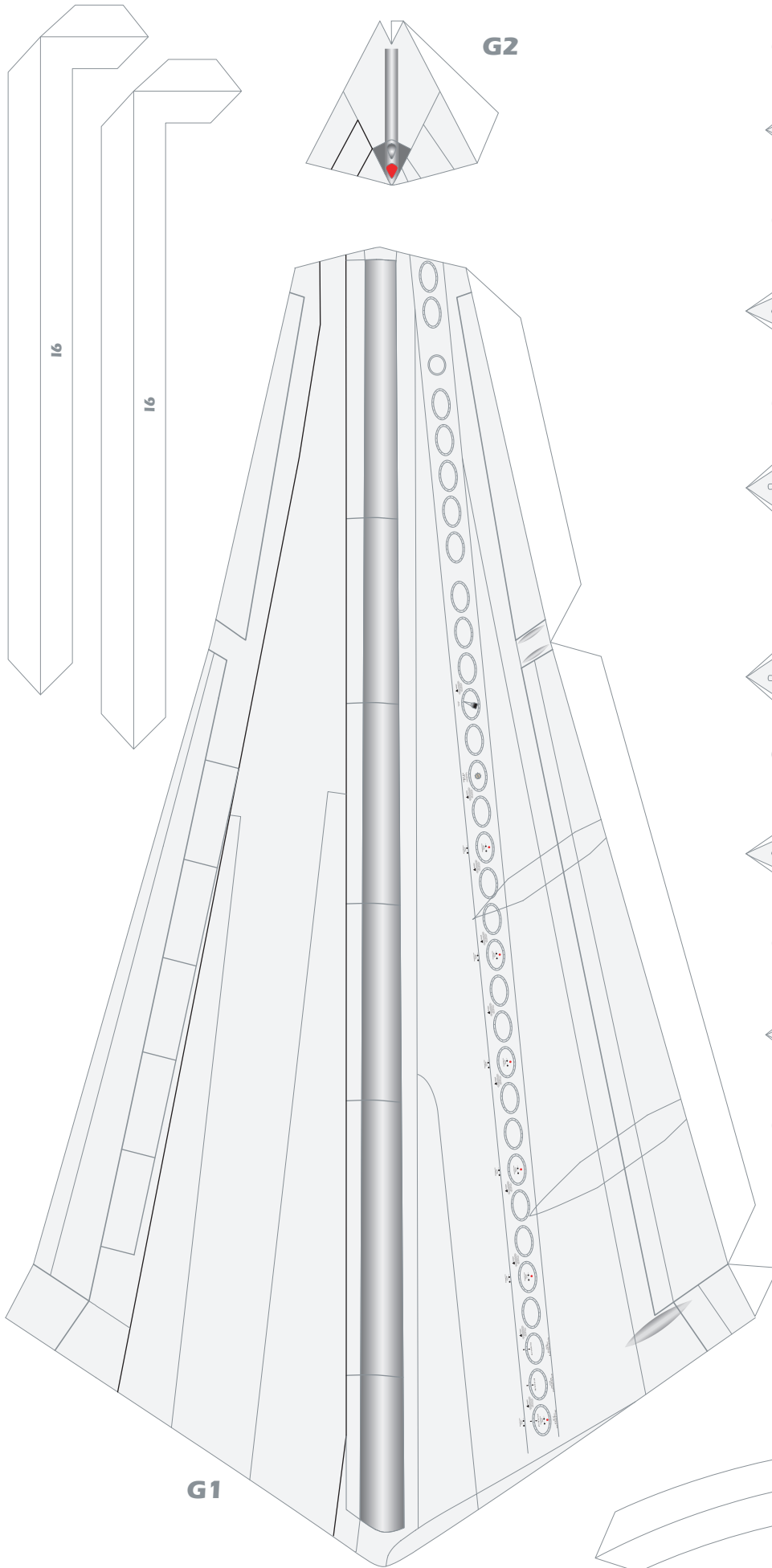

G9R



G10R

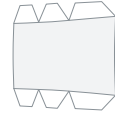

G11R

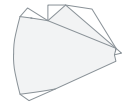

G6R

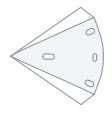

G7R



G8R



G3R



G4R

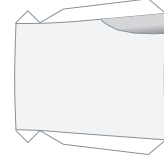

G5R

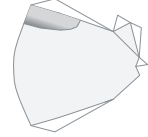

G3L



G4L

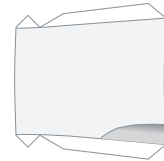

G5L

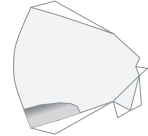

G6L



G7L



G8L



G9L



G10L

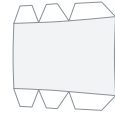

G11L

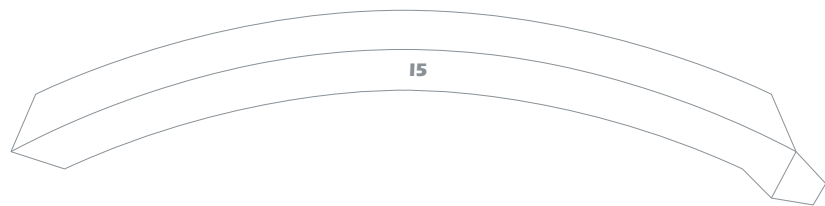
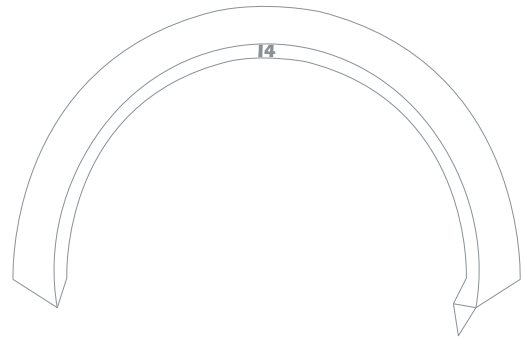
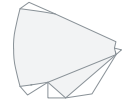

Repainted by: Christopher Roden

© 2020 Edwin Rodriguez

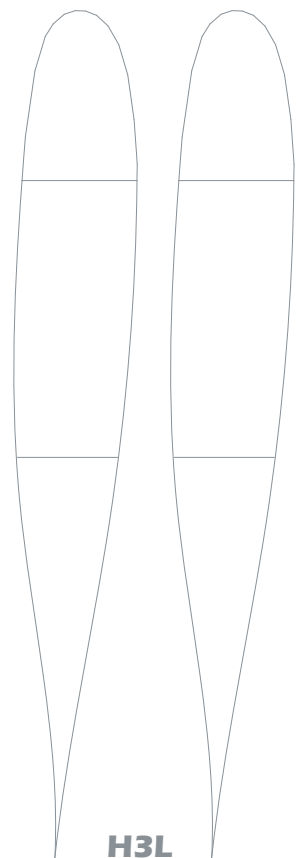
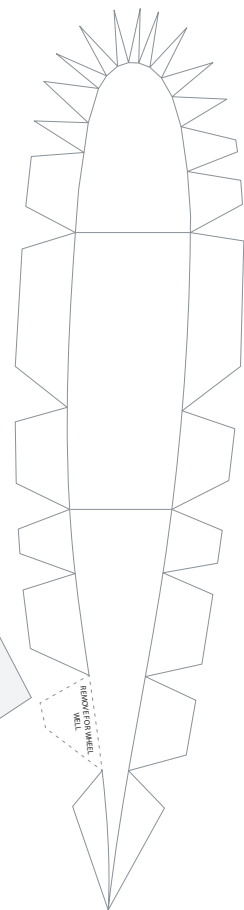
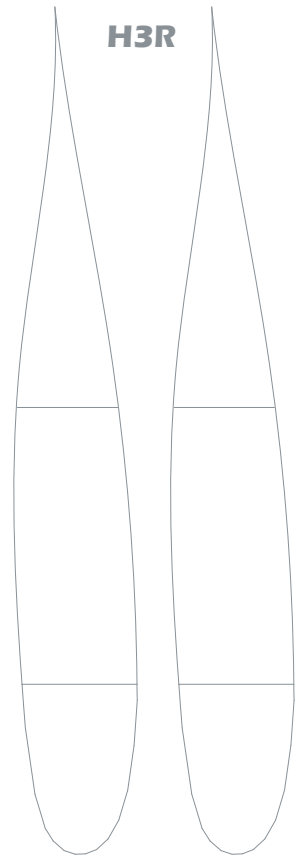
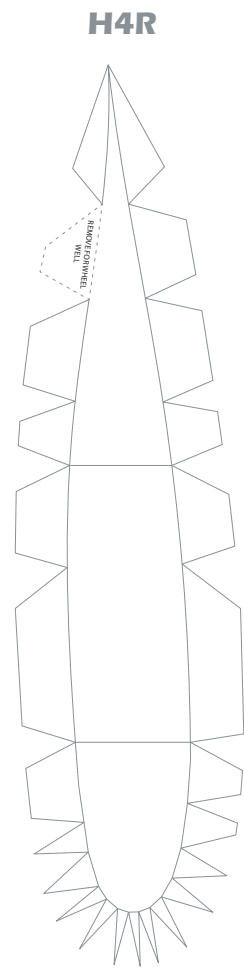
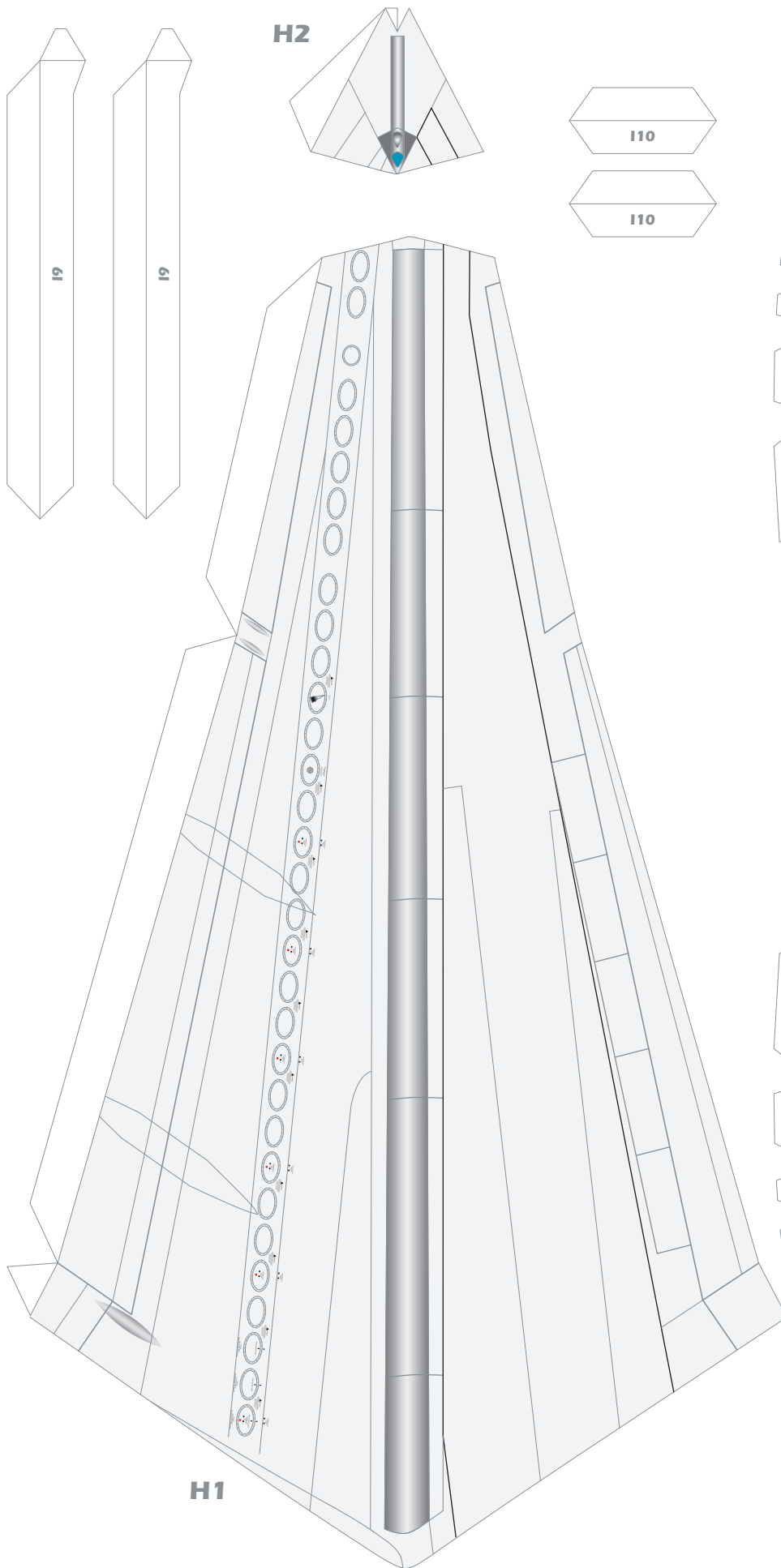

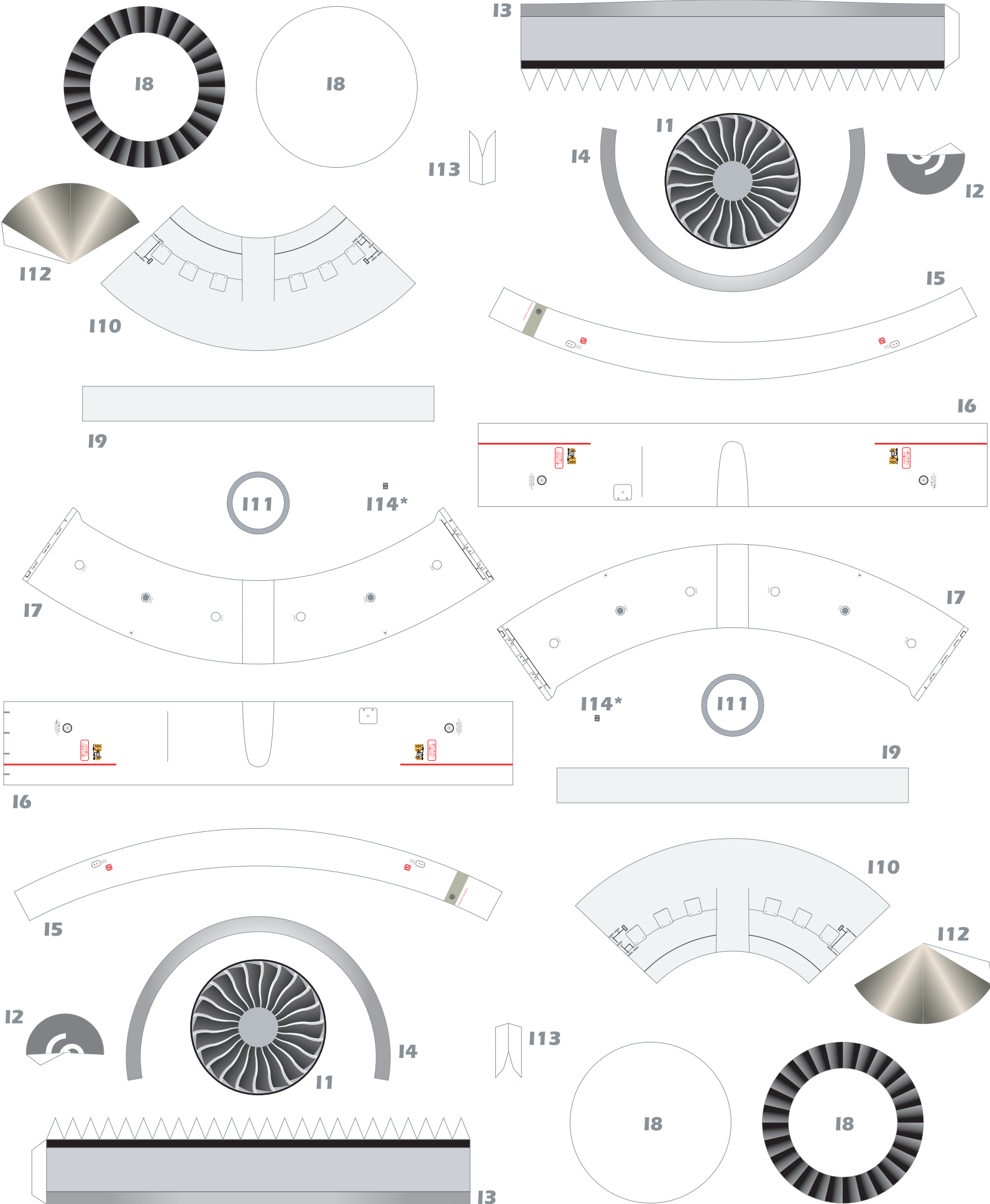

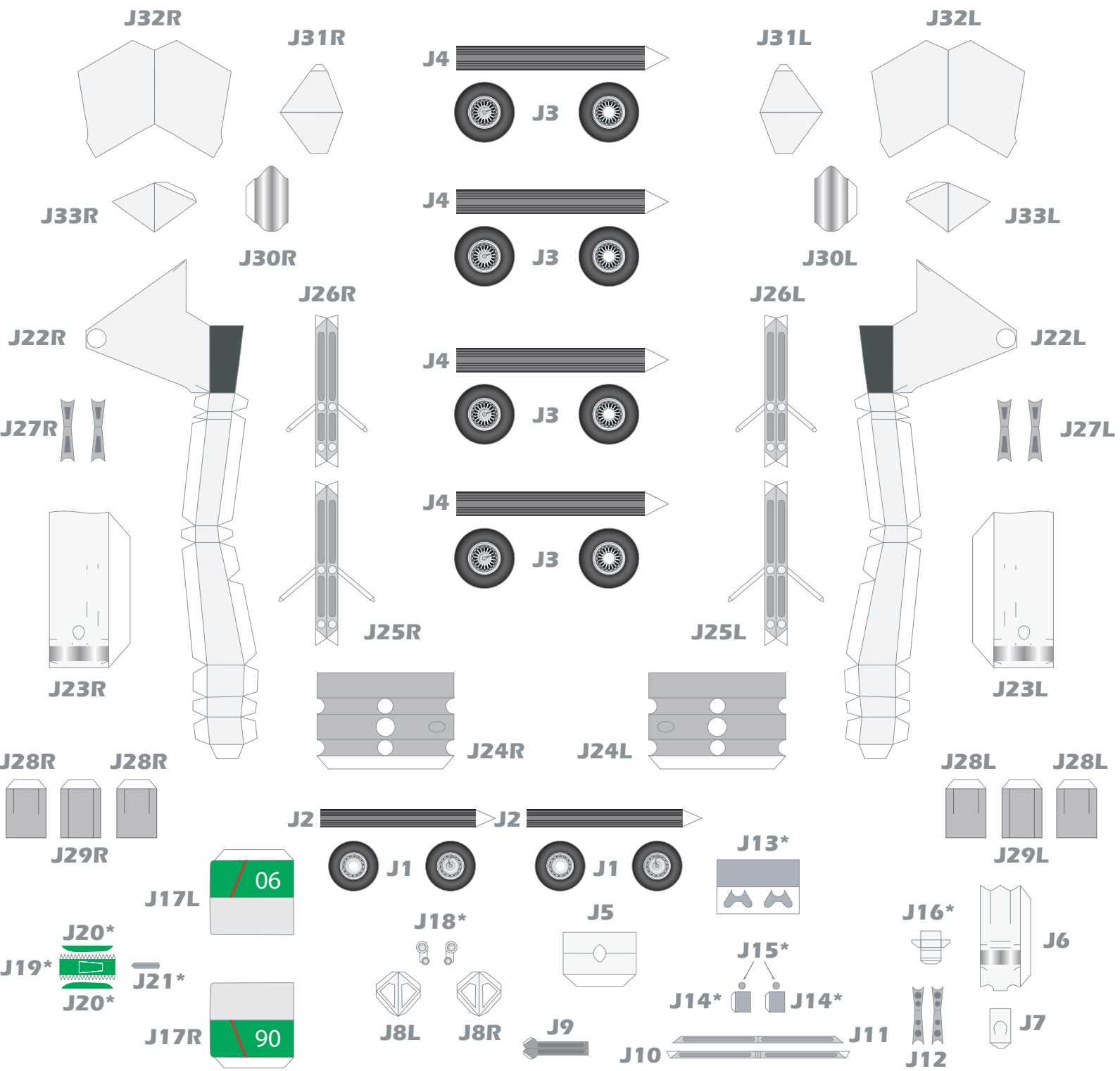
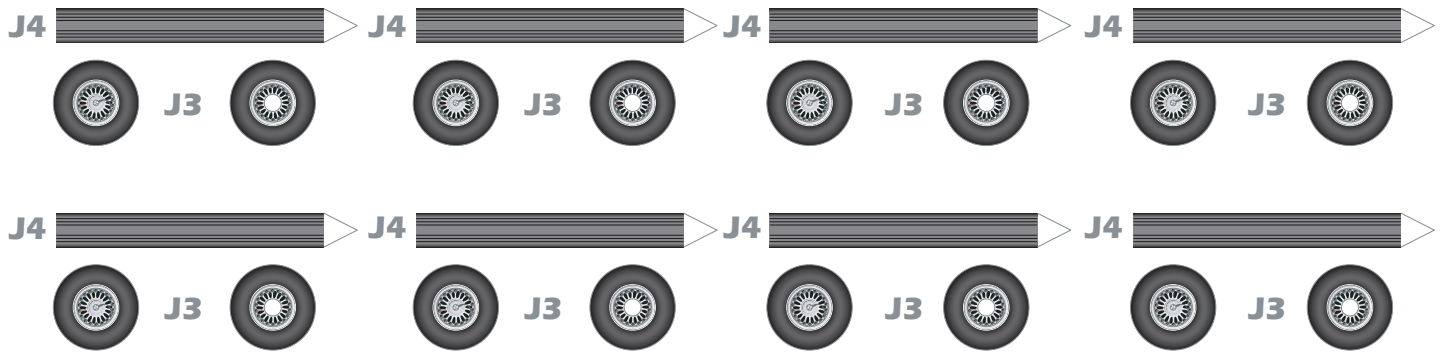

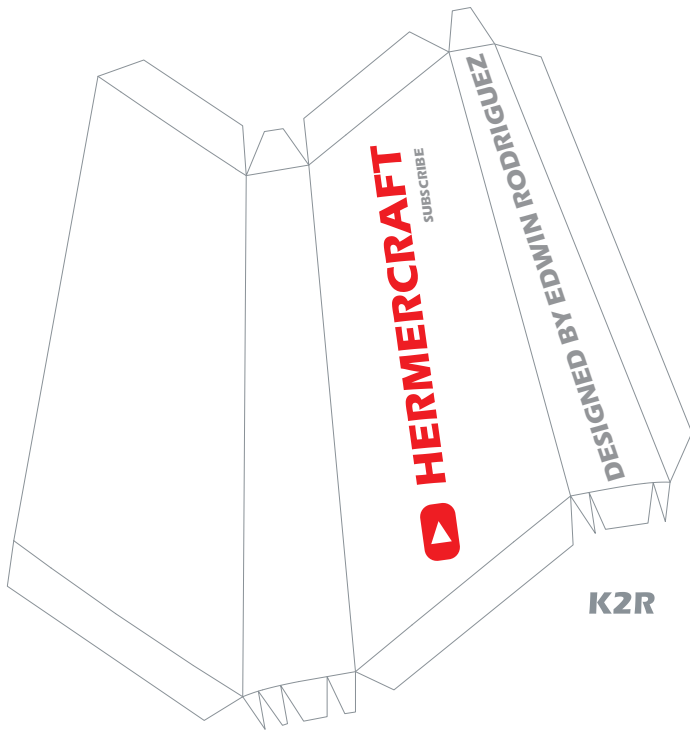

K2R

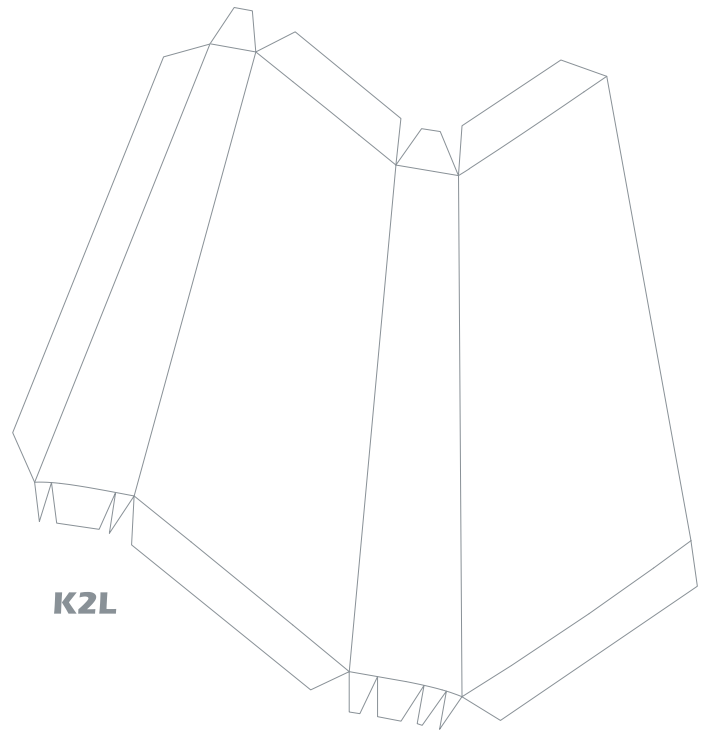

K2L

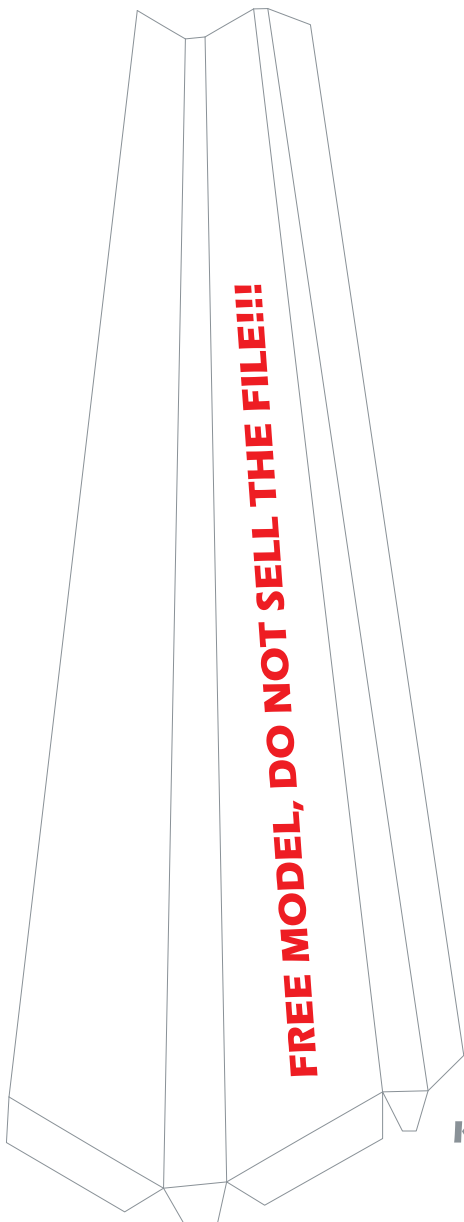

K3R

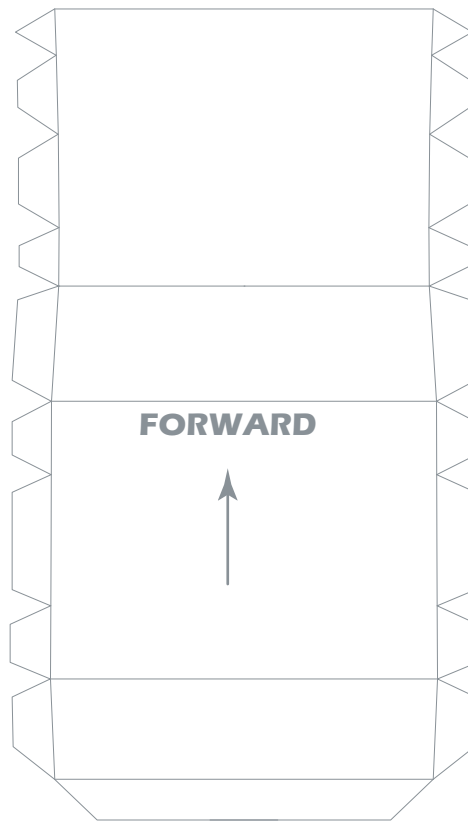

K1

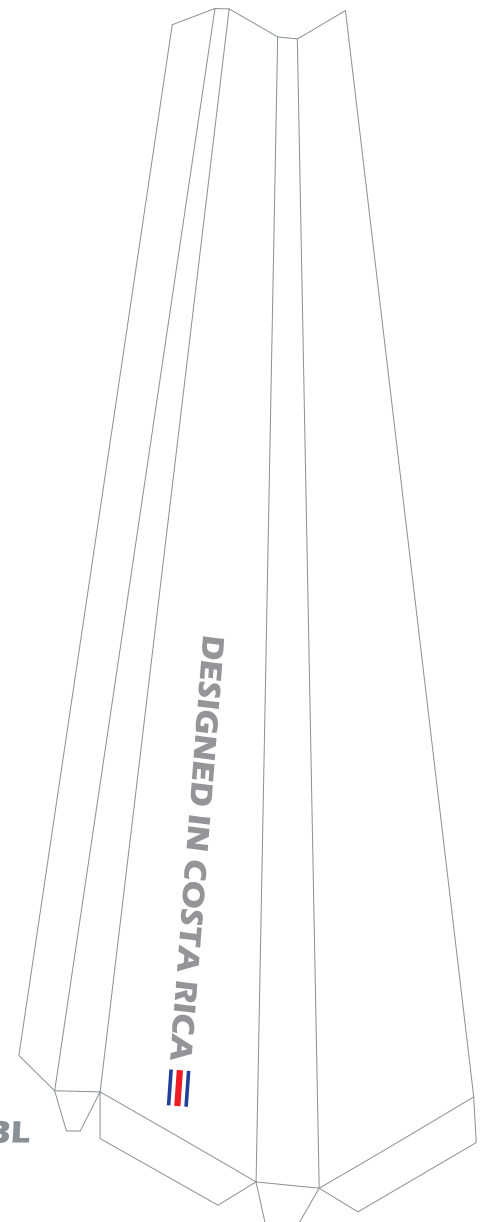

K3L

L5

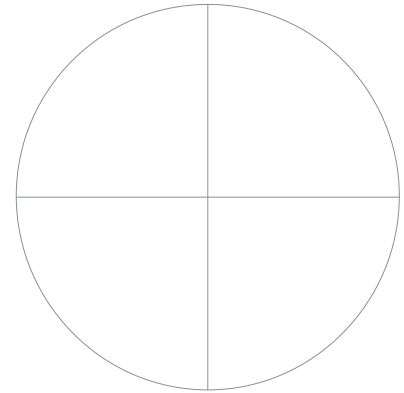
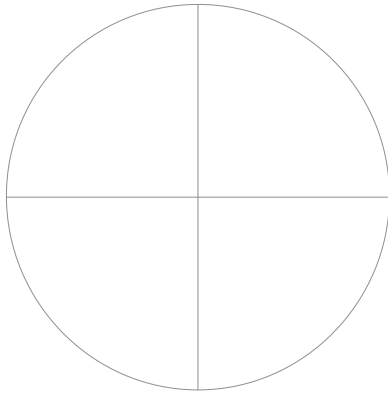
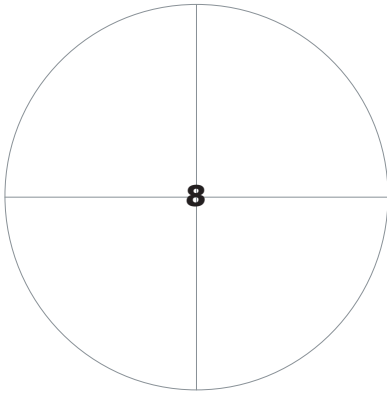

L4

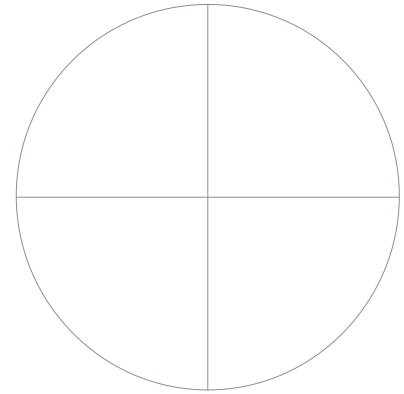
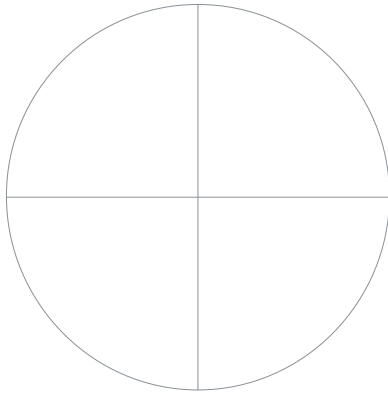
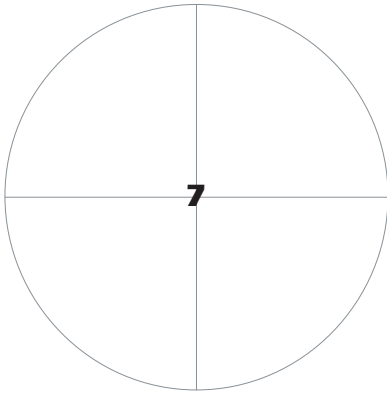

L3

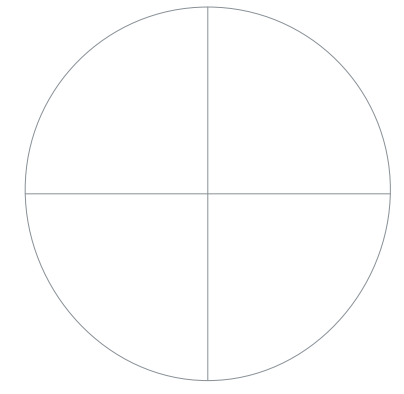
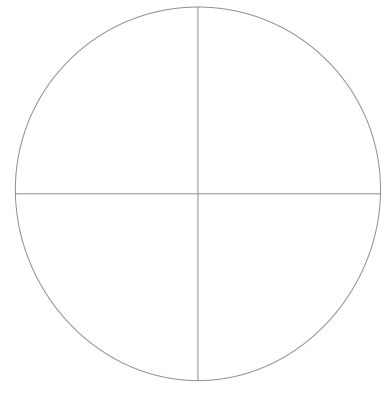
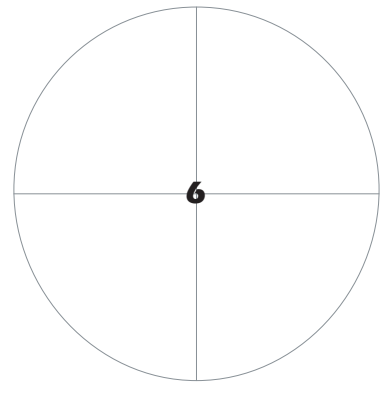

L2

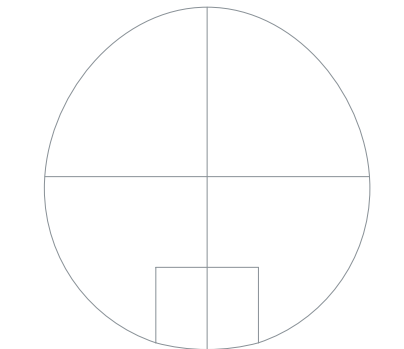
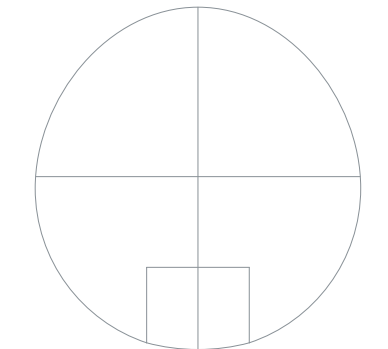
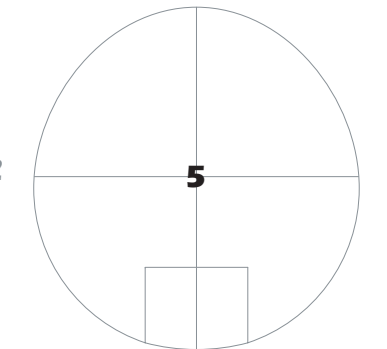

L1

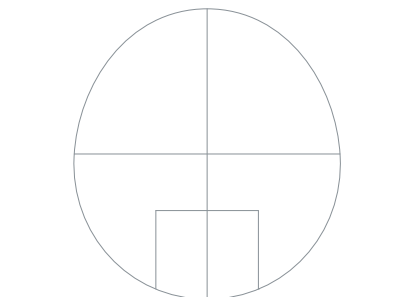
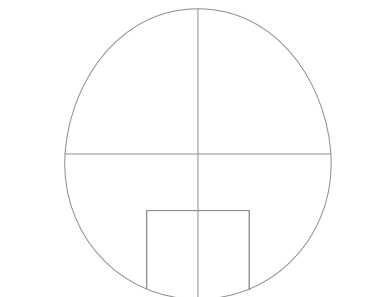
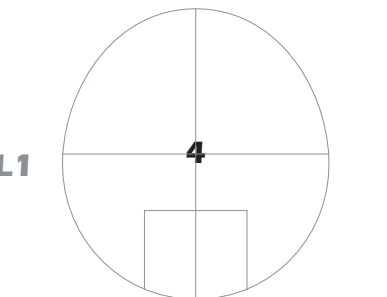

M4

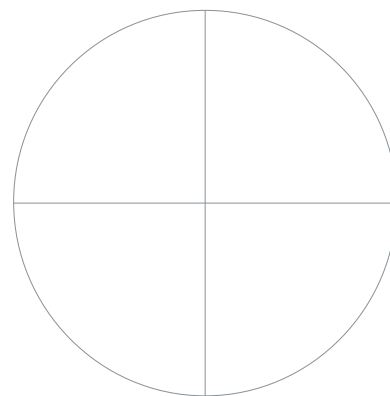
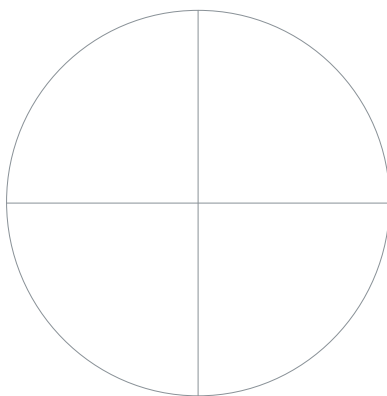
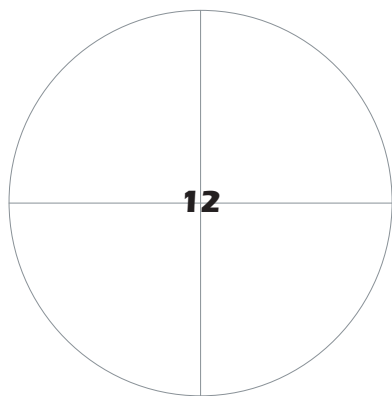

M3

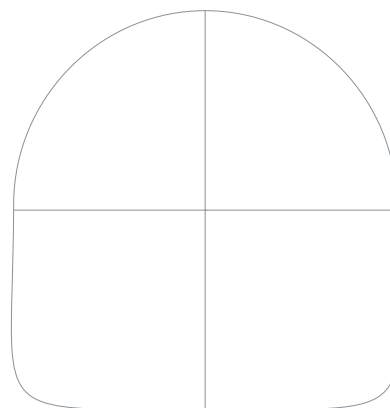
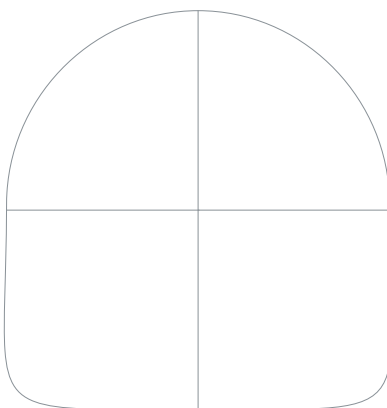
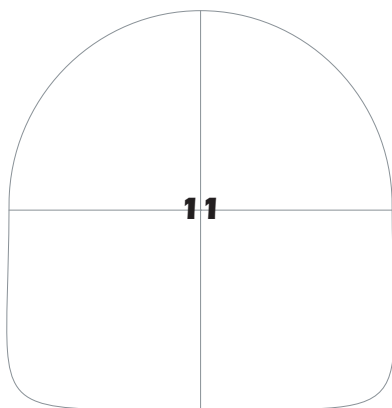

M2

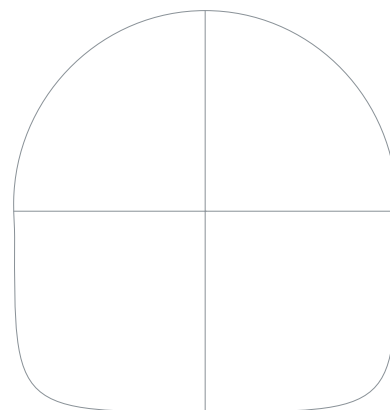
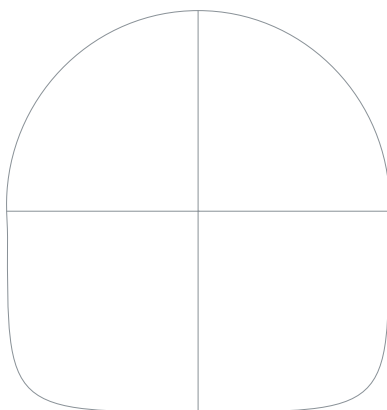
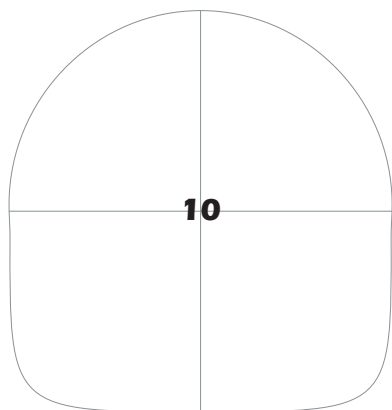

M1

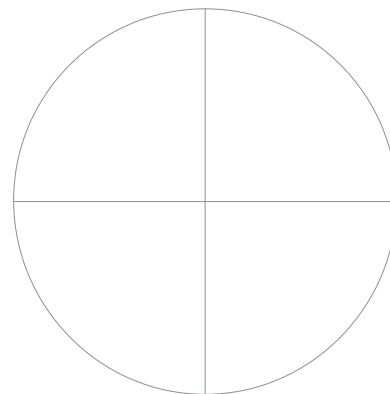
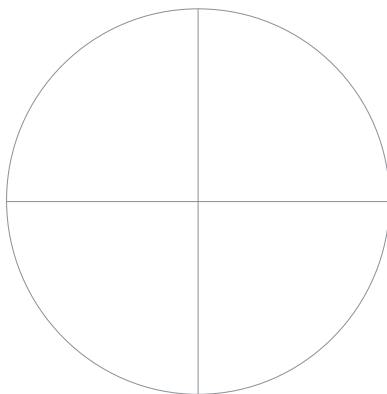
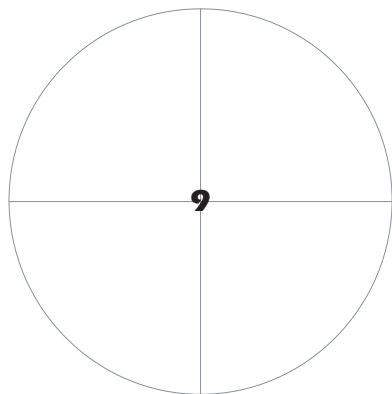

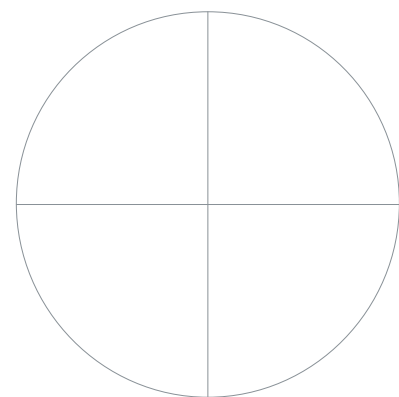
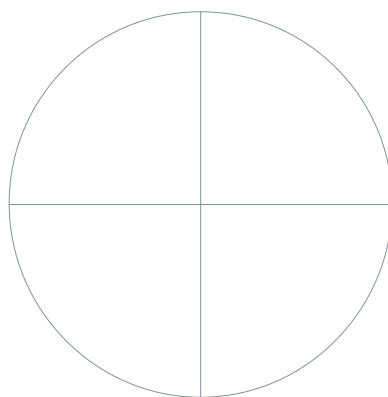
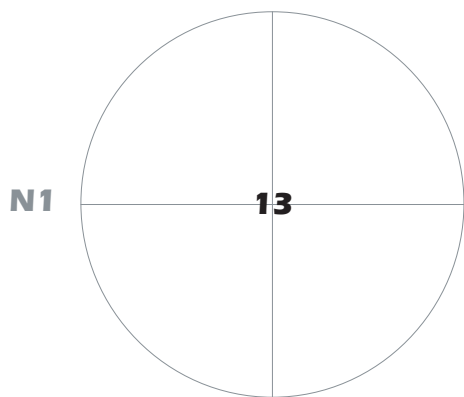
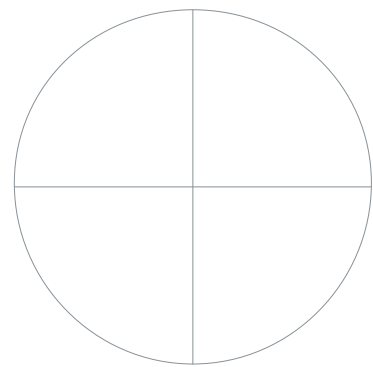
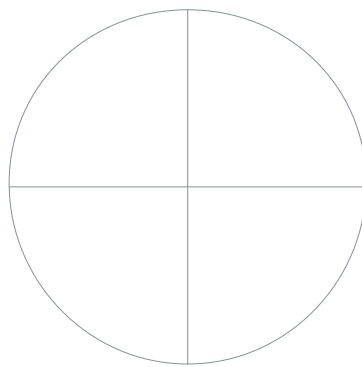
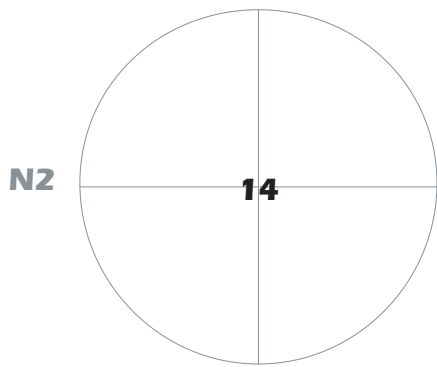
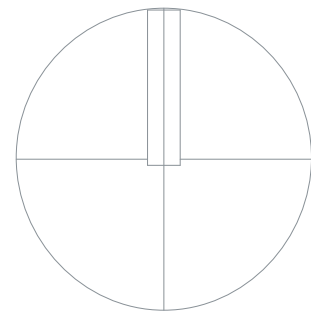
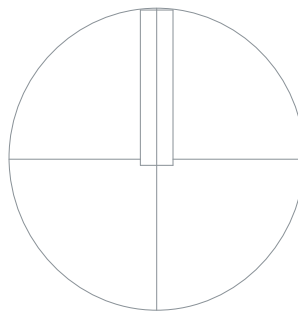
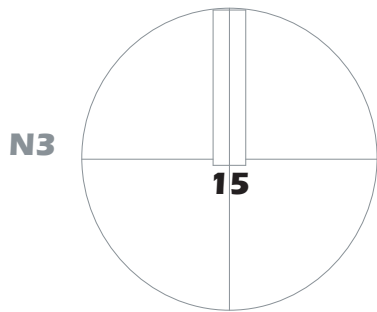
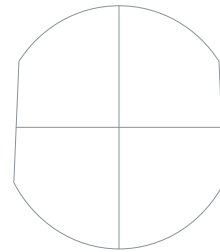
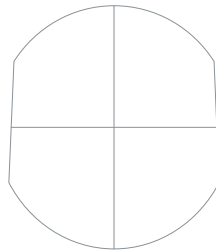
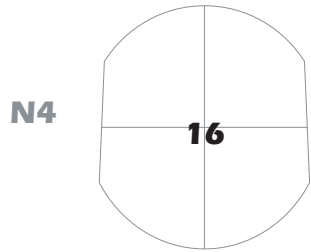
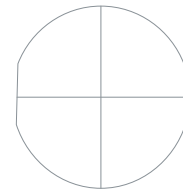
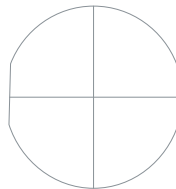

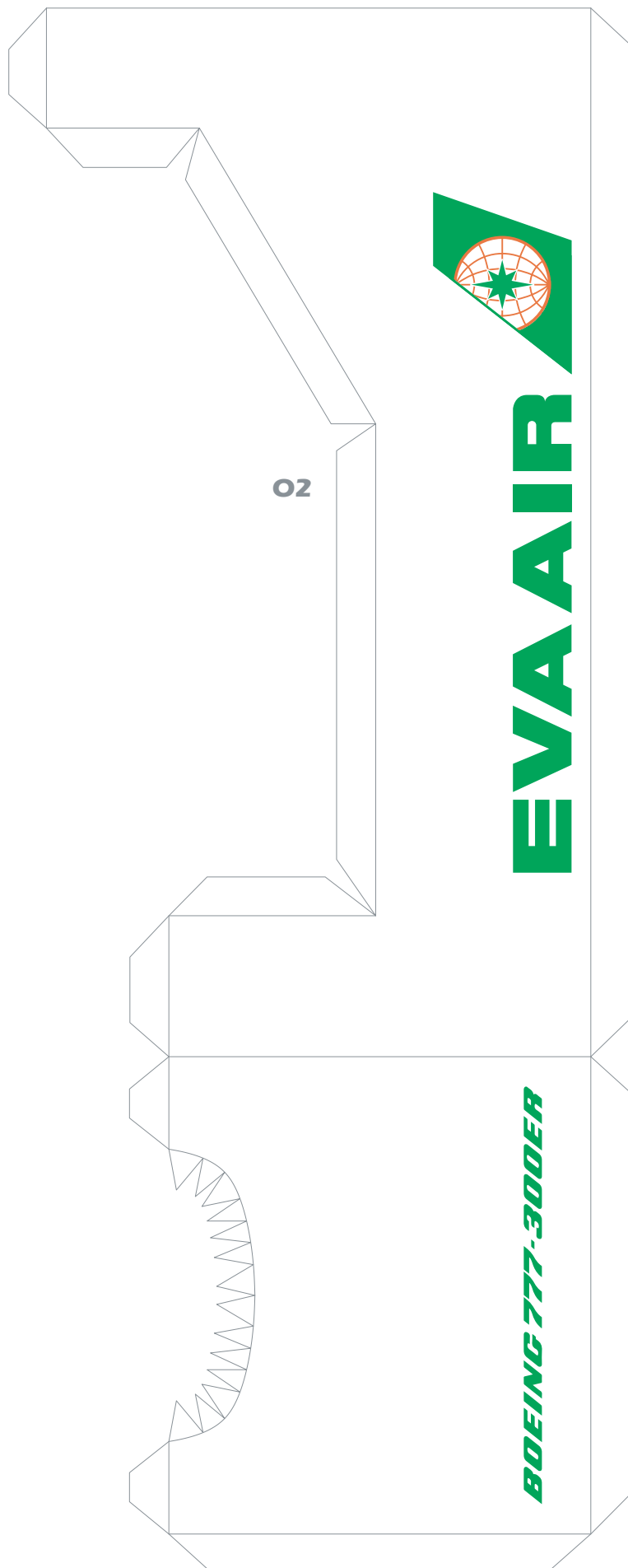
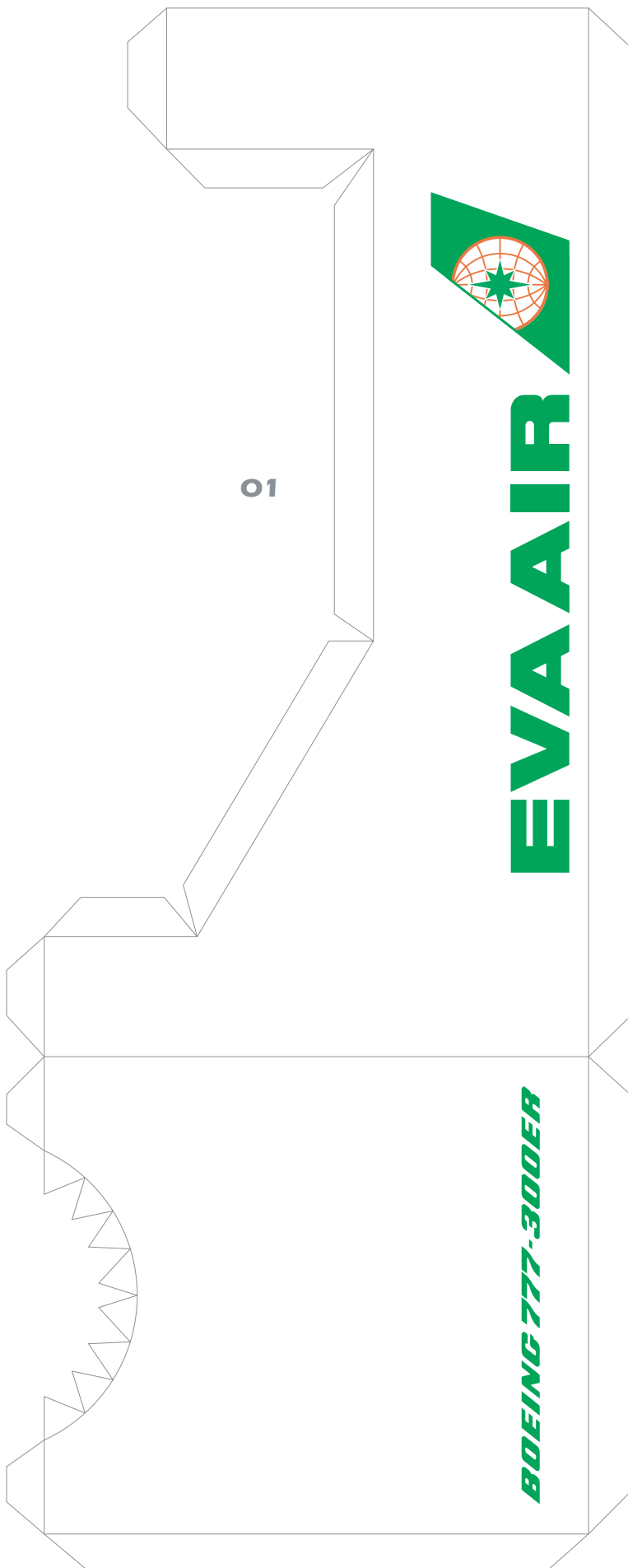

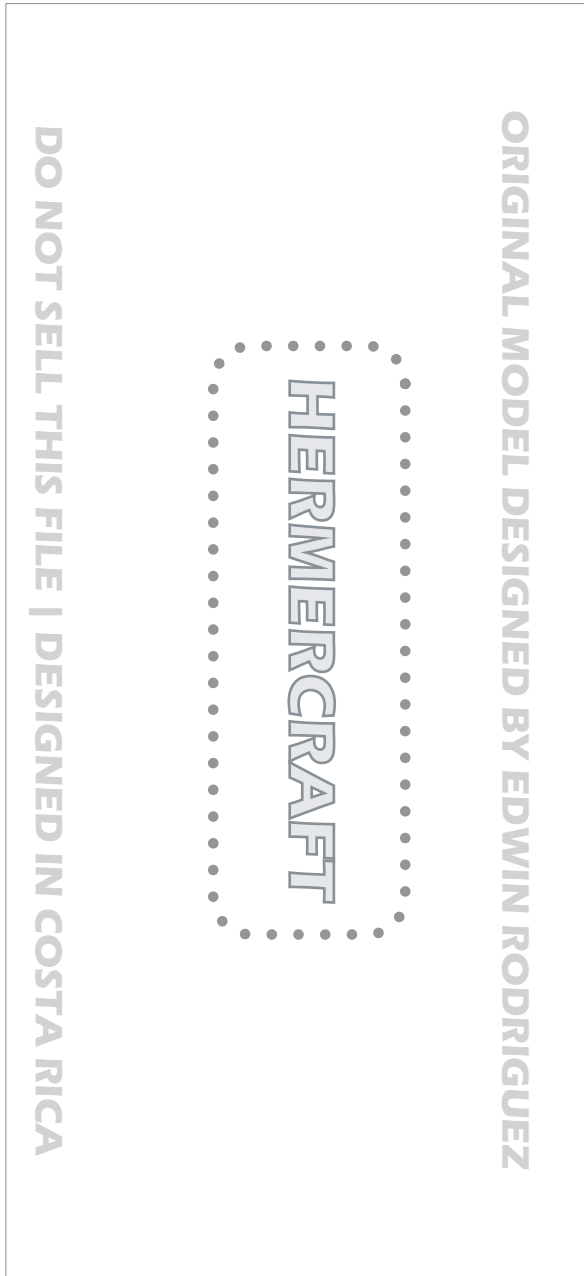

P4

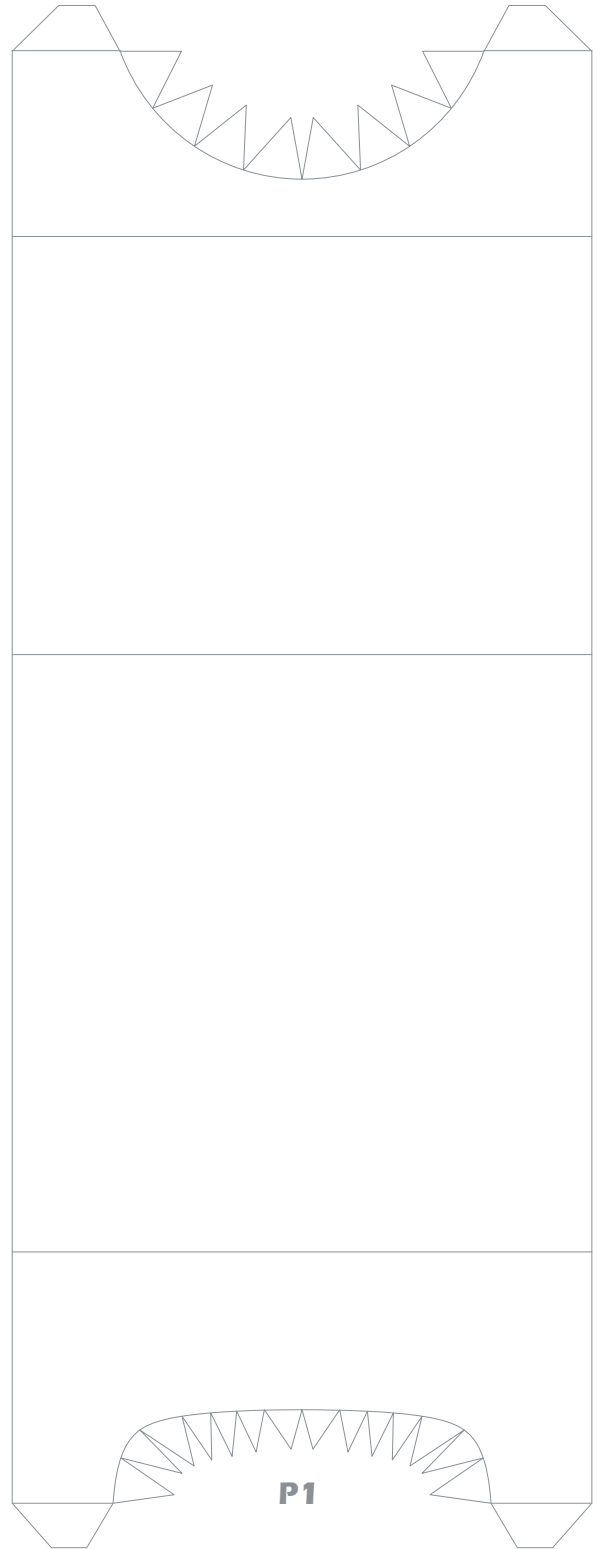

P1



P2



P3

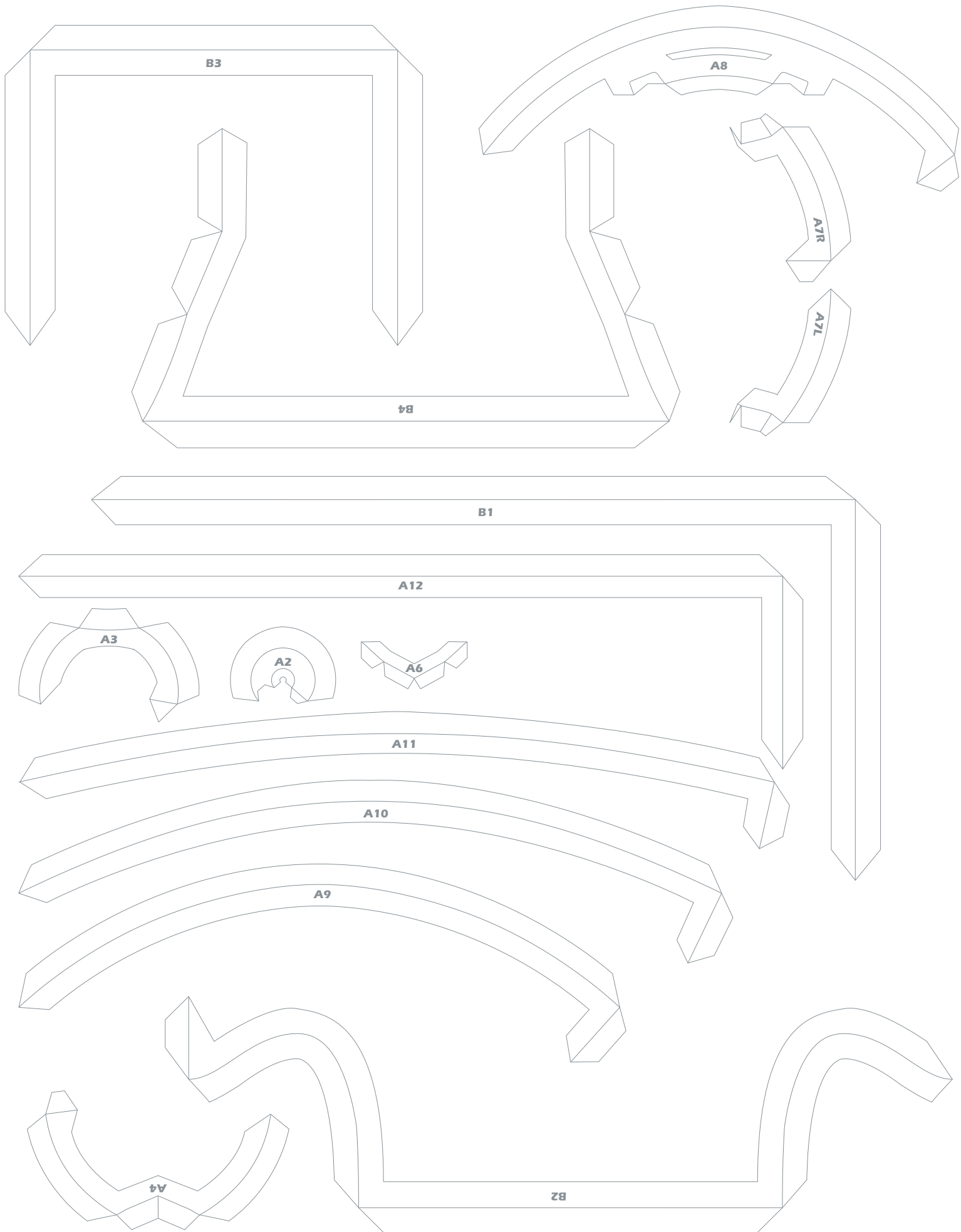

Repainted by: Christopher Roden

© 2020 Edwin Rodriguez

