

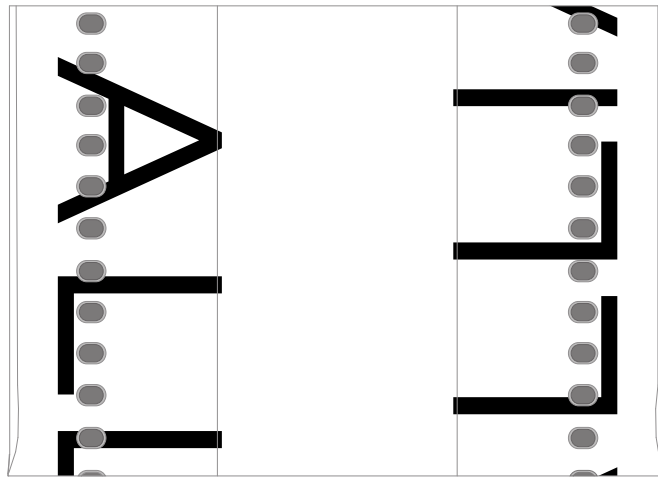

- B5\* B7\* B9\*
- B6\* B8\* B10\*

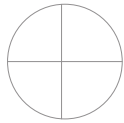

B3

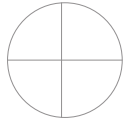
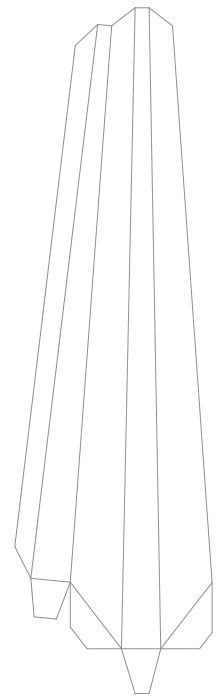

B13

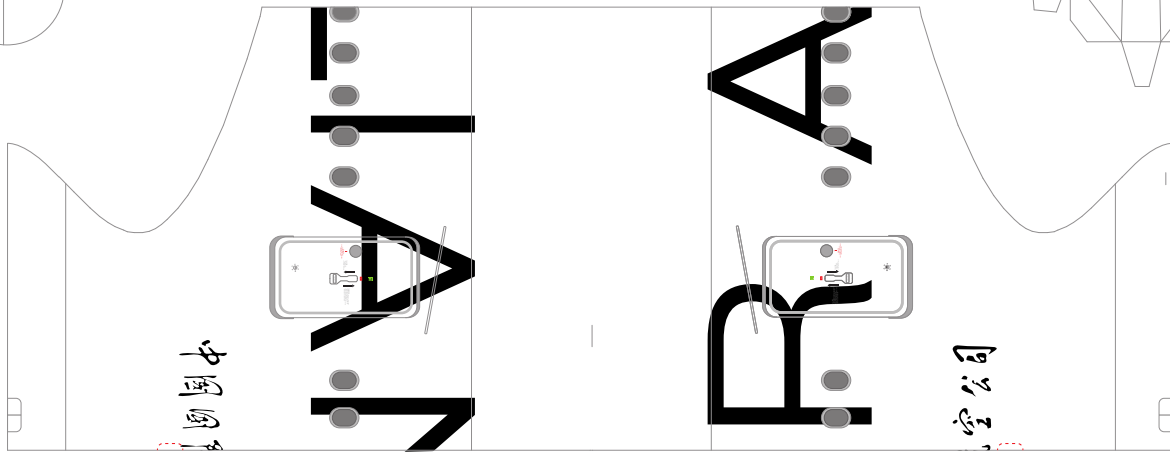

B2

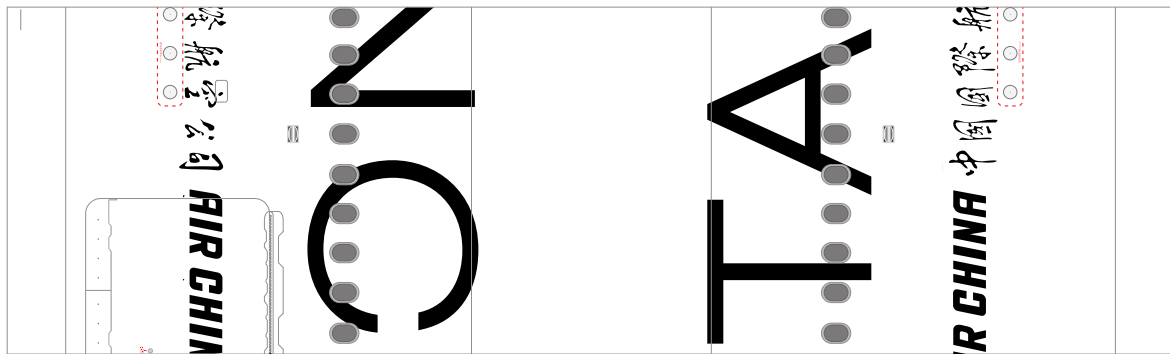

B1

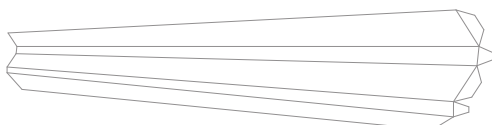

B12R

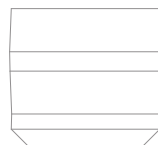

B11



B12L

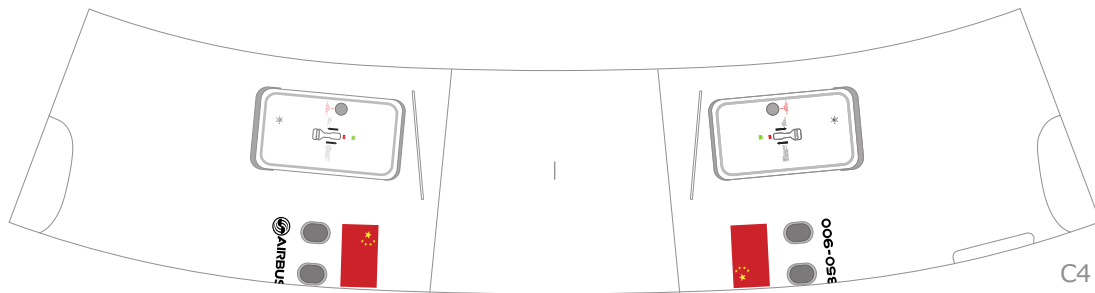

C4

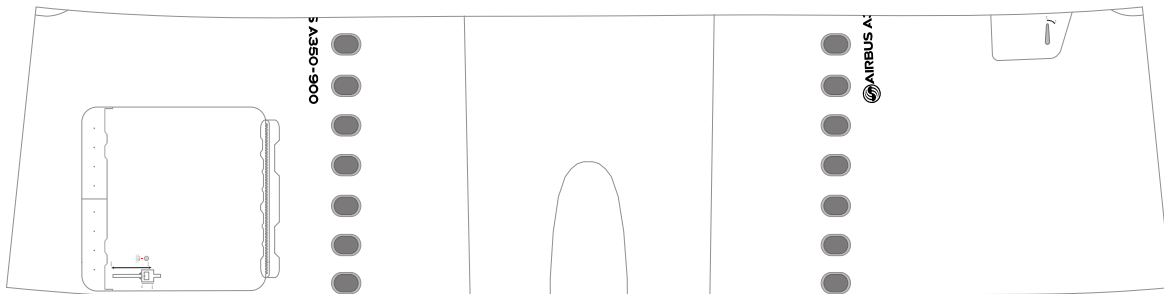

C3



C2

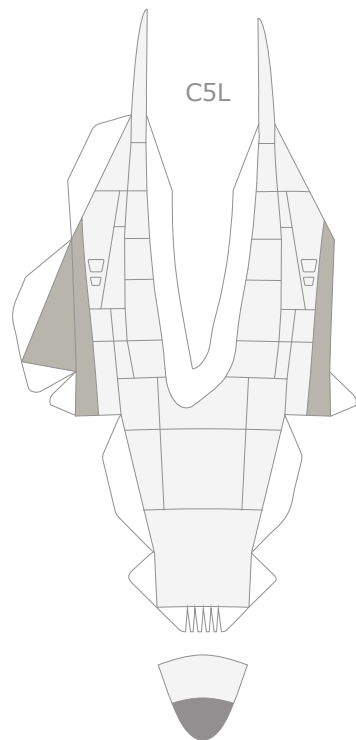

C5L

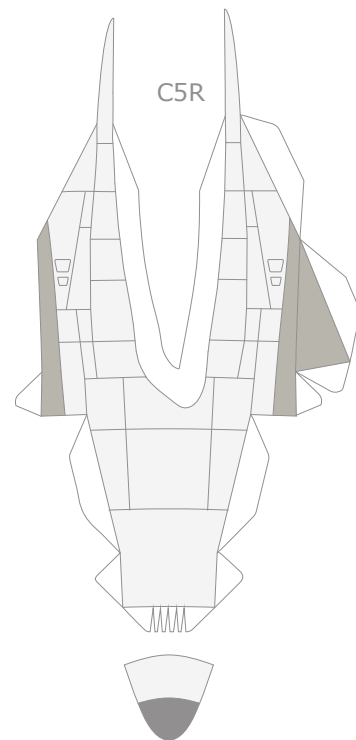

C5R

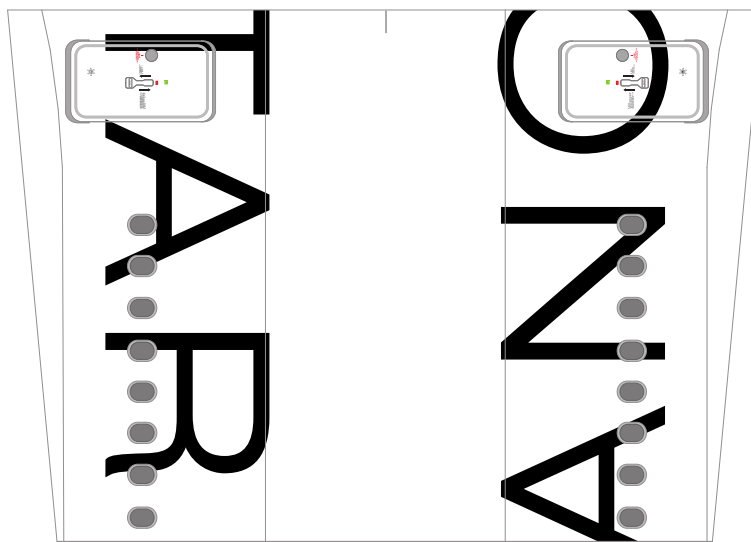

C1

C6L

C6R

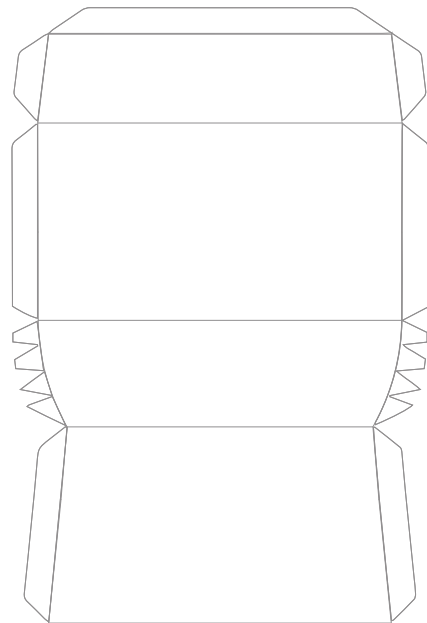
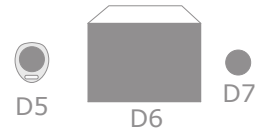
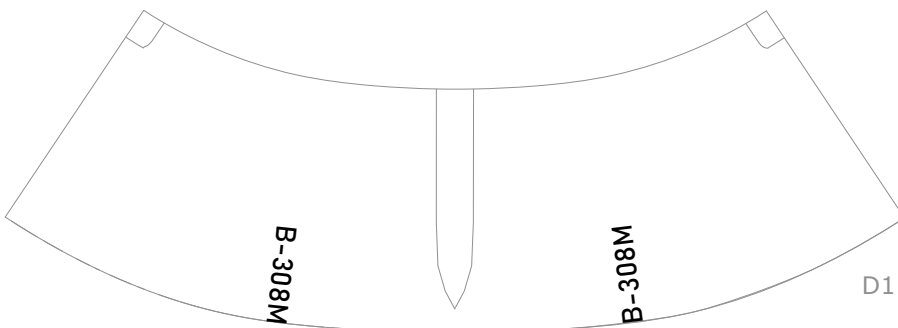
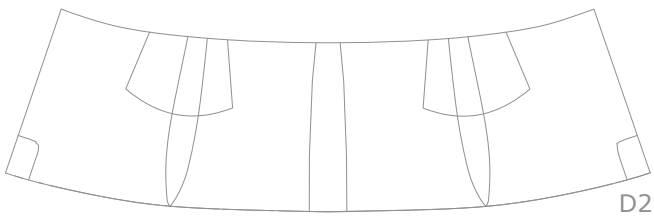
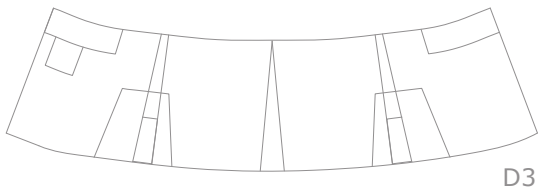
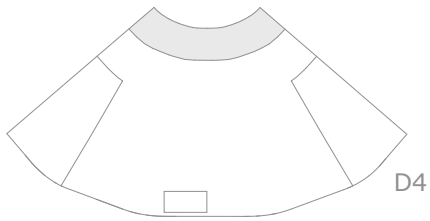
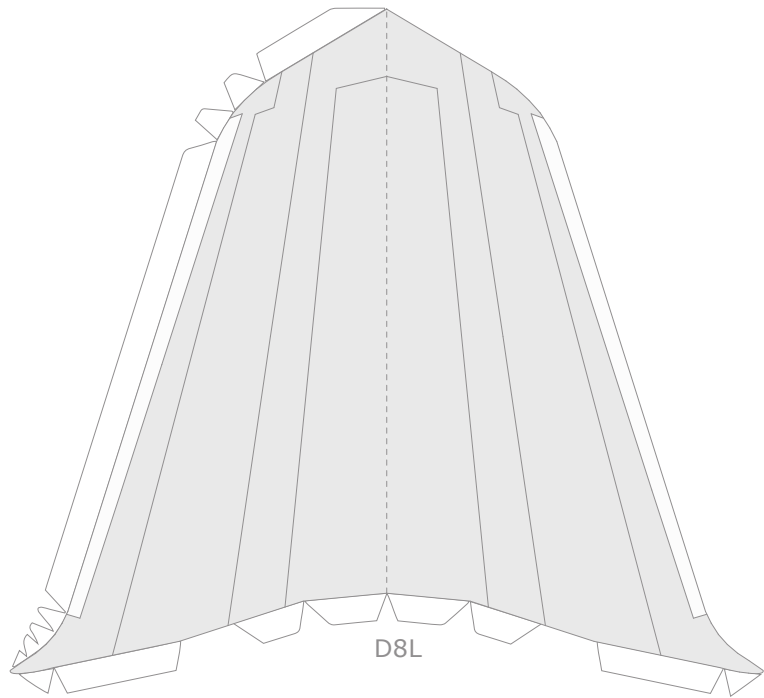
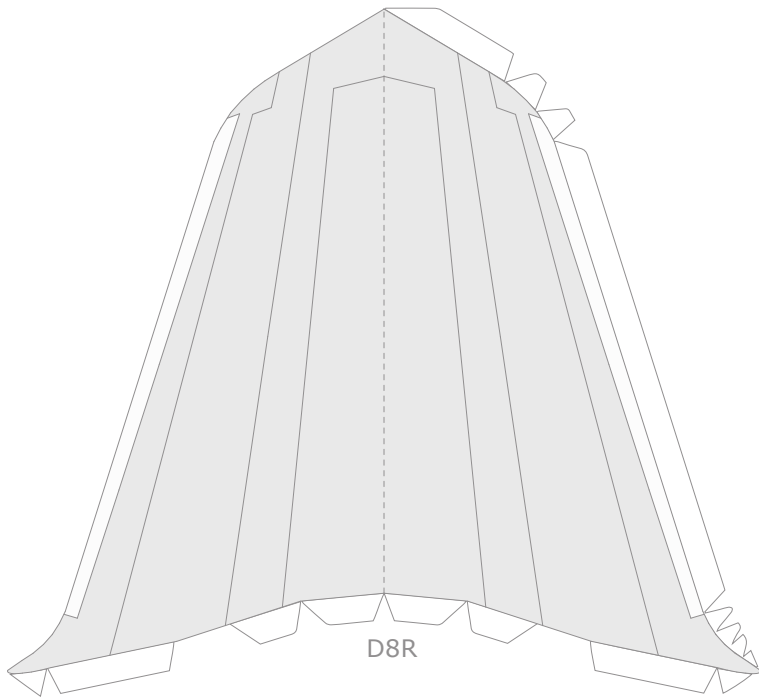

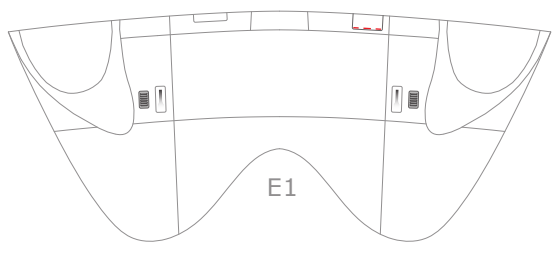
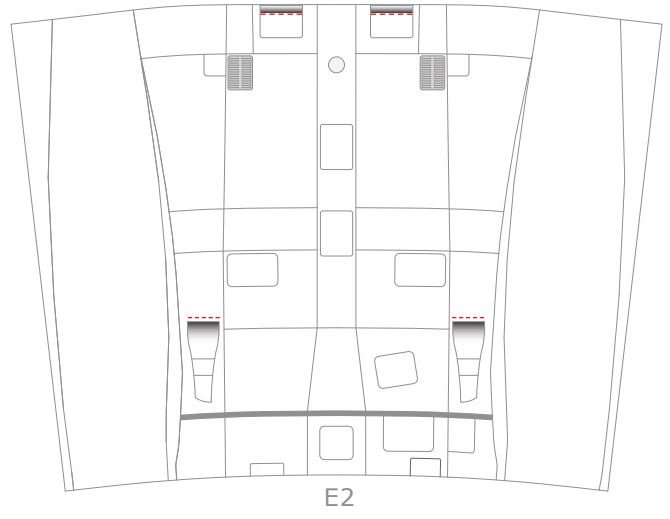
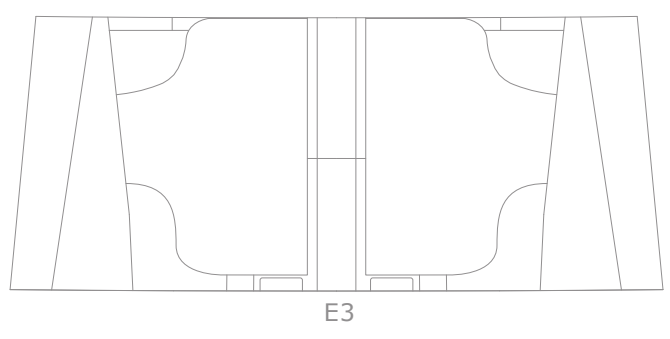
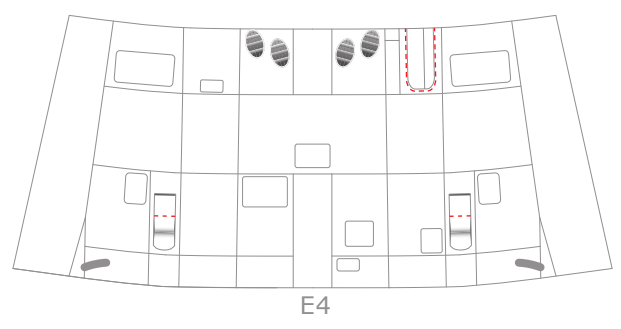
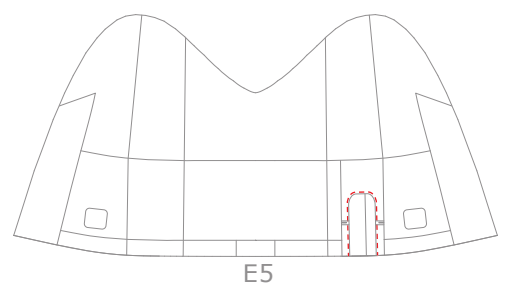
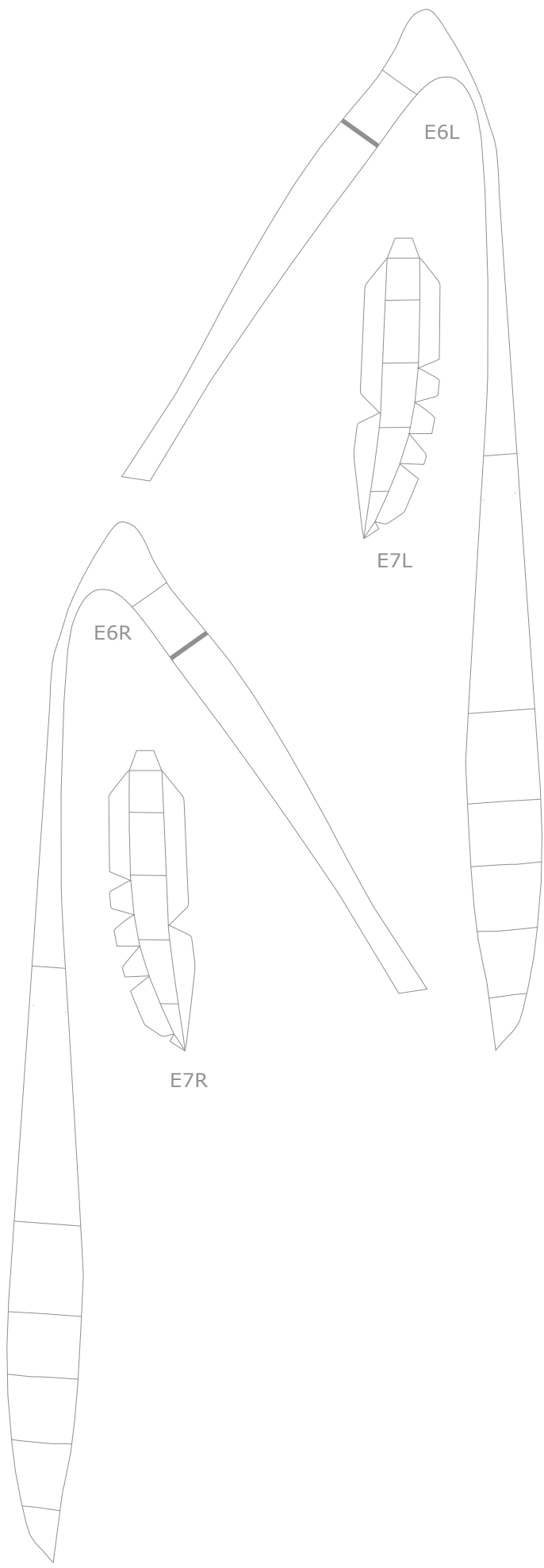

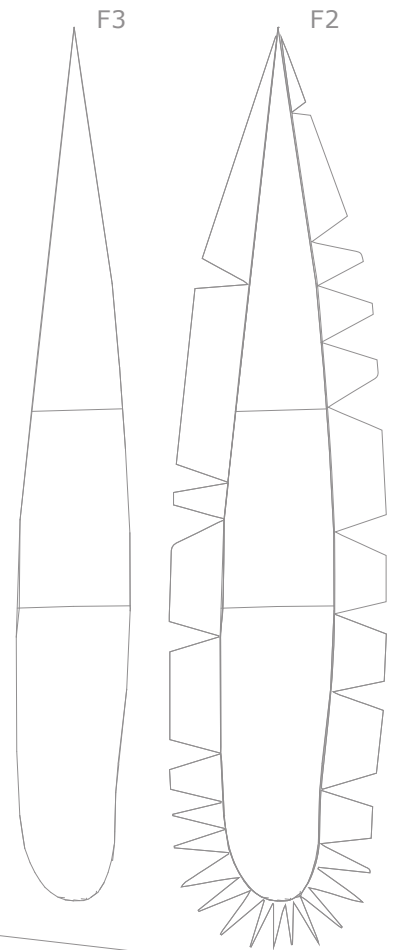
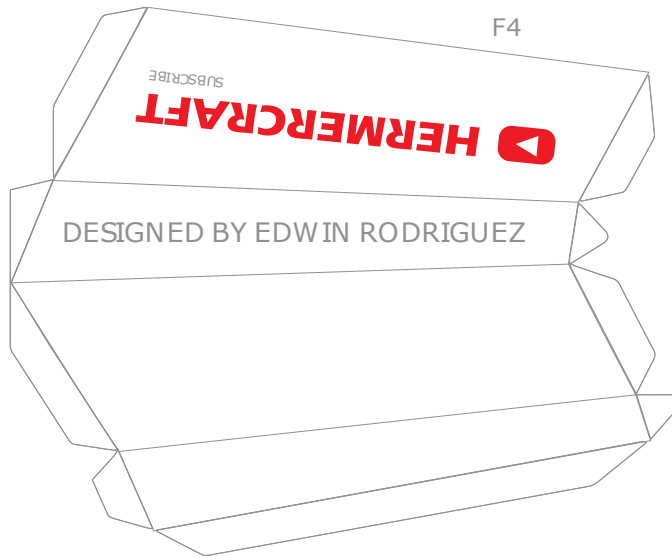
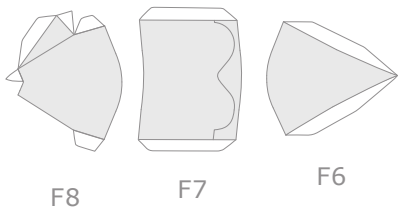
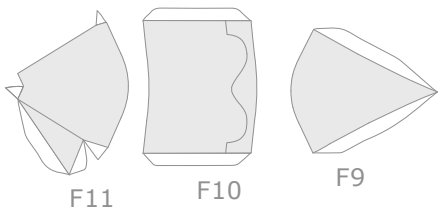
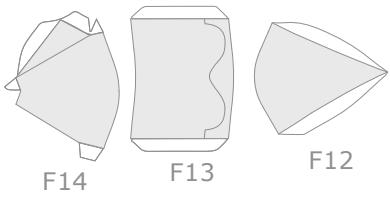
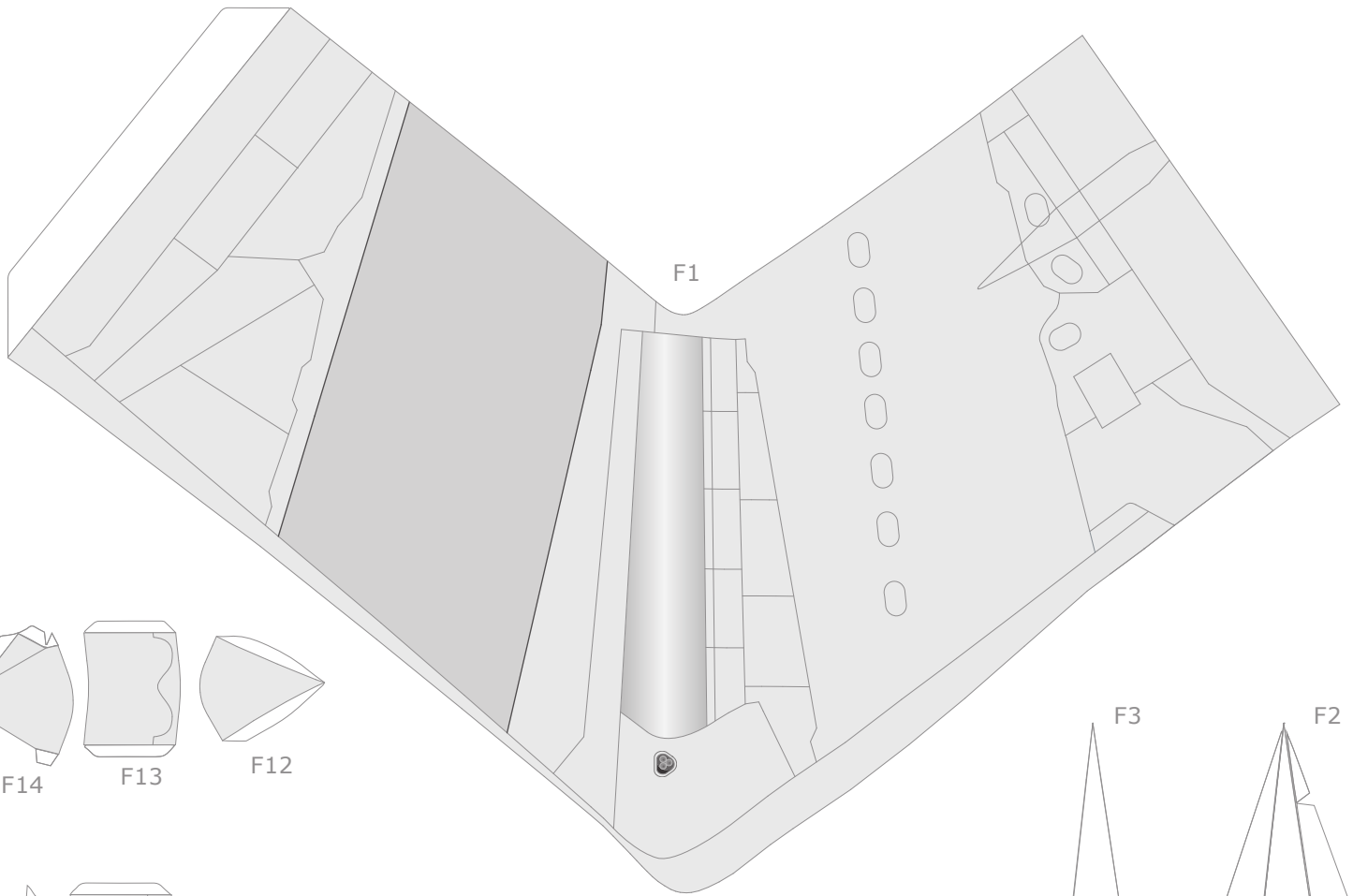

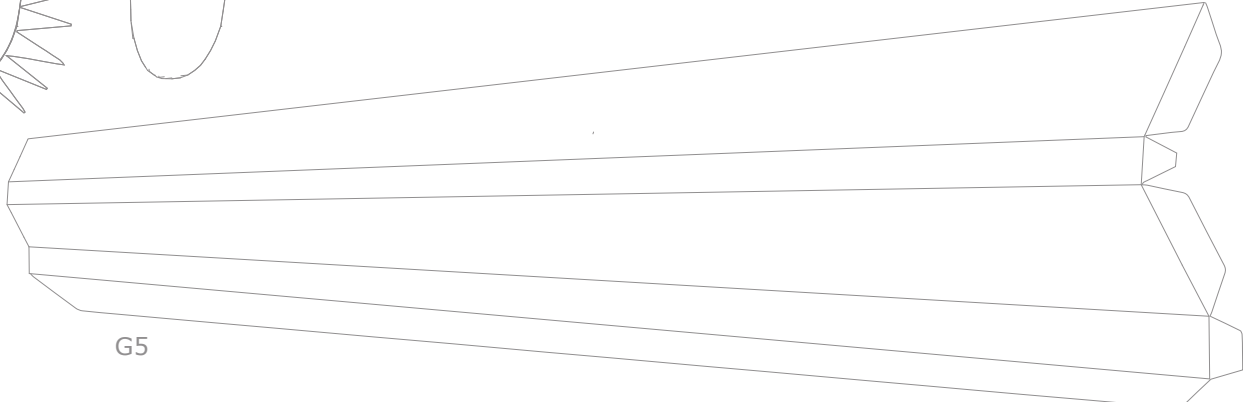
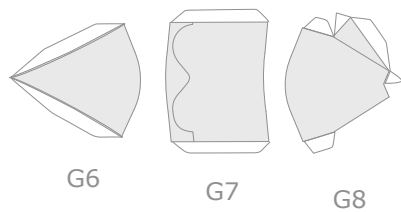
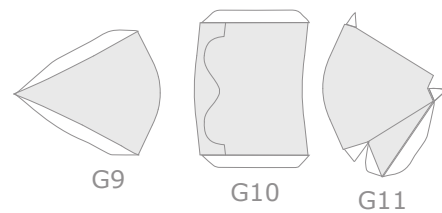
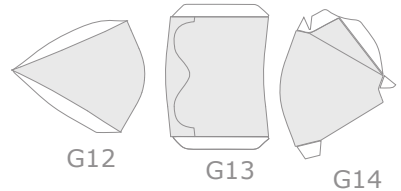
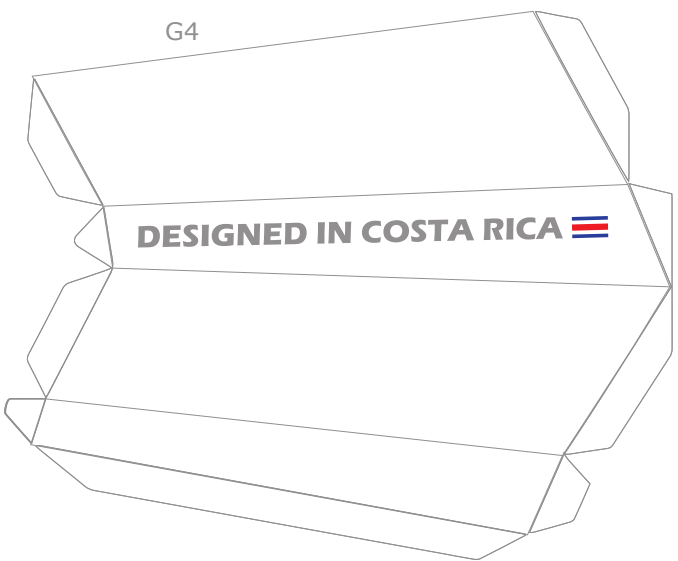
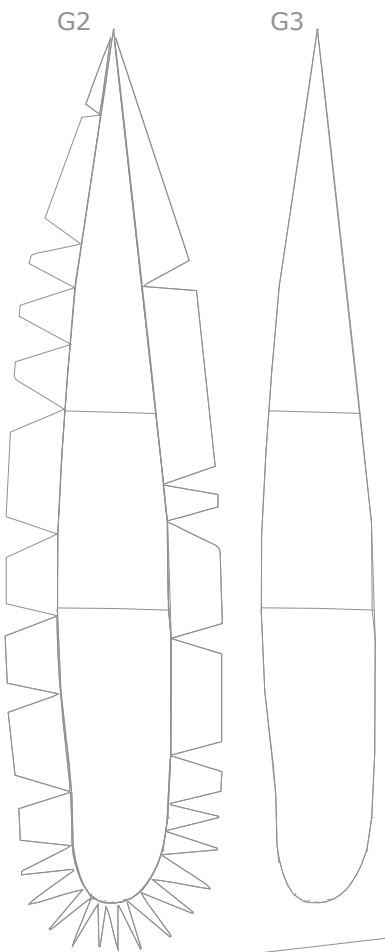
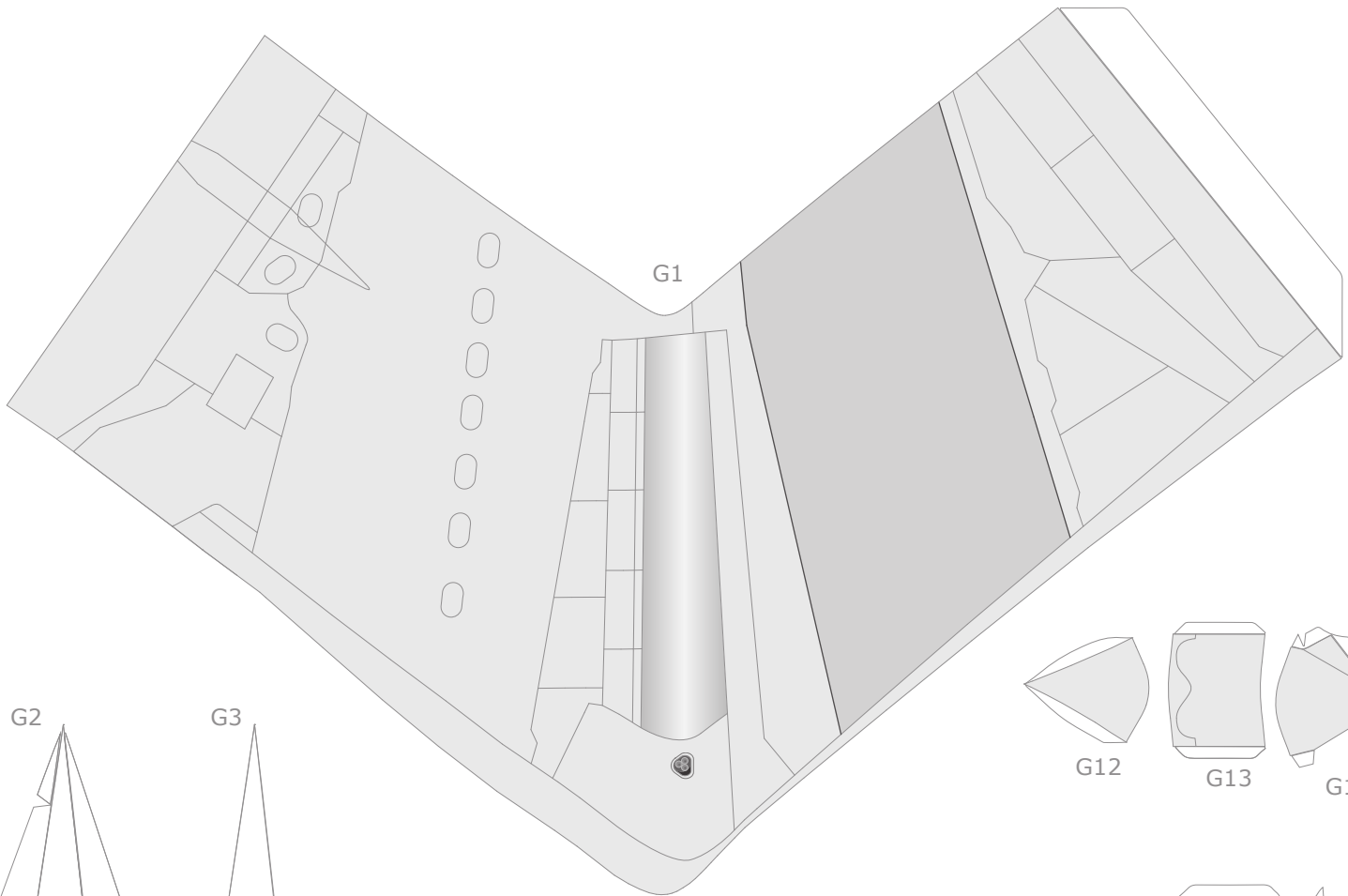

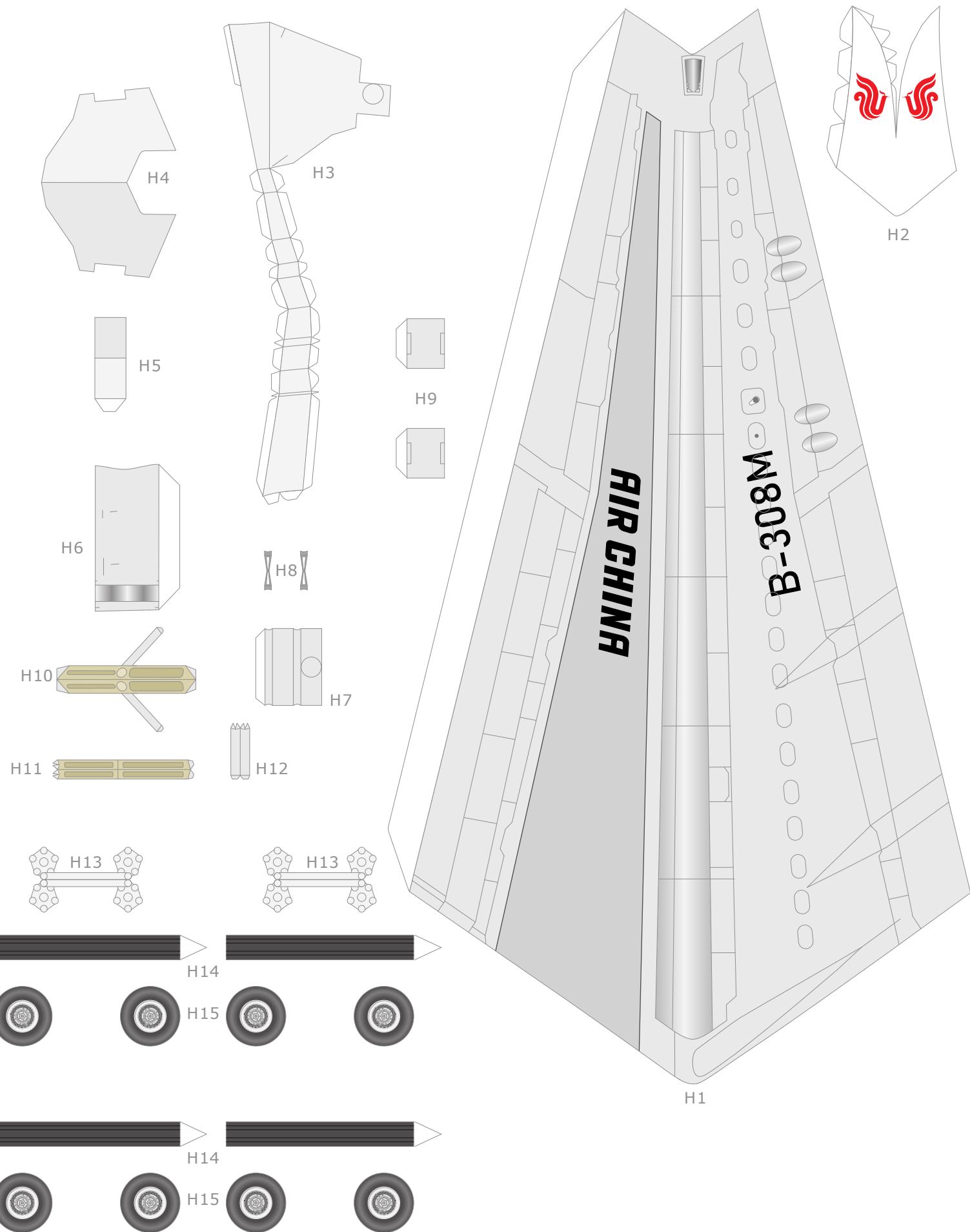



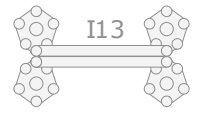
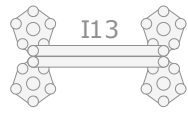
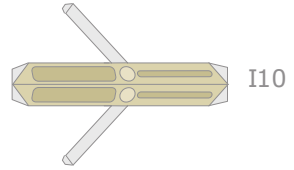
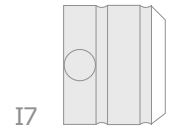
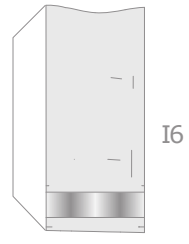
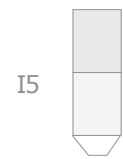
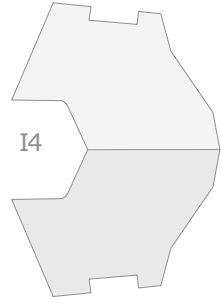
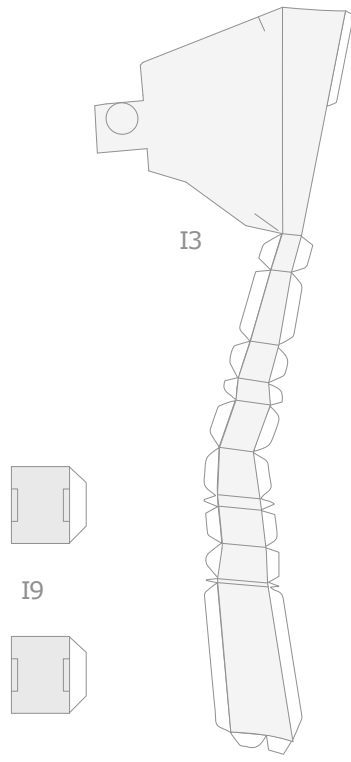
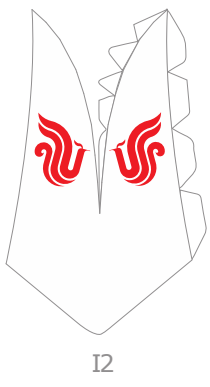
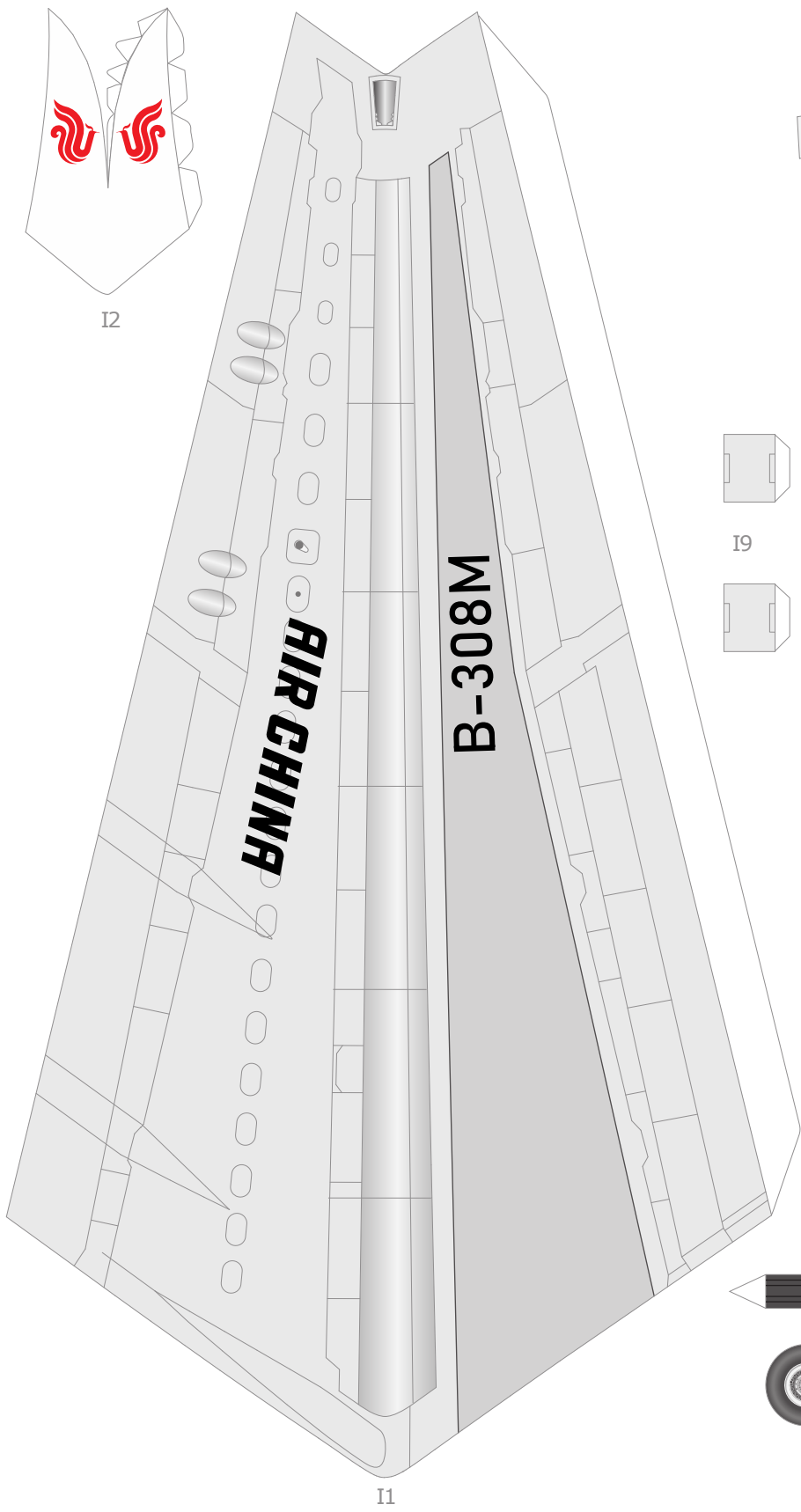

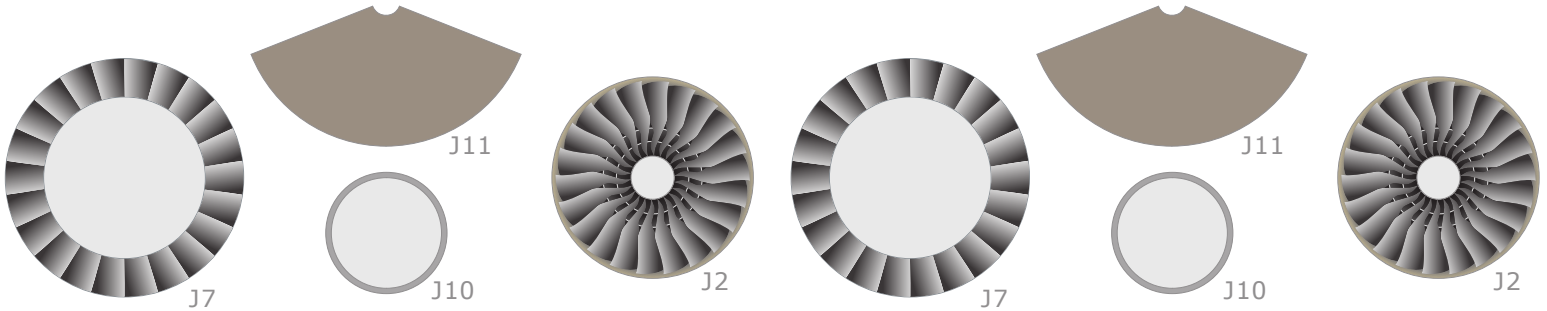
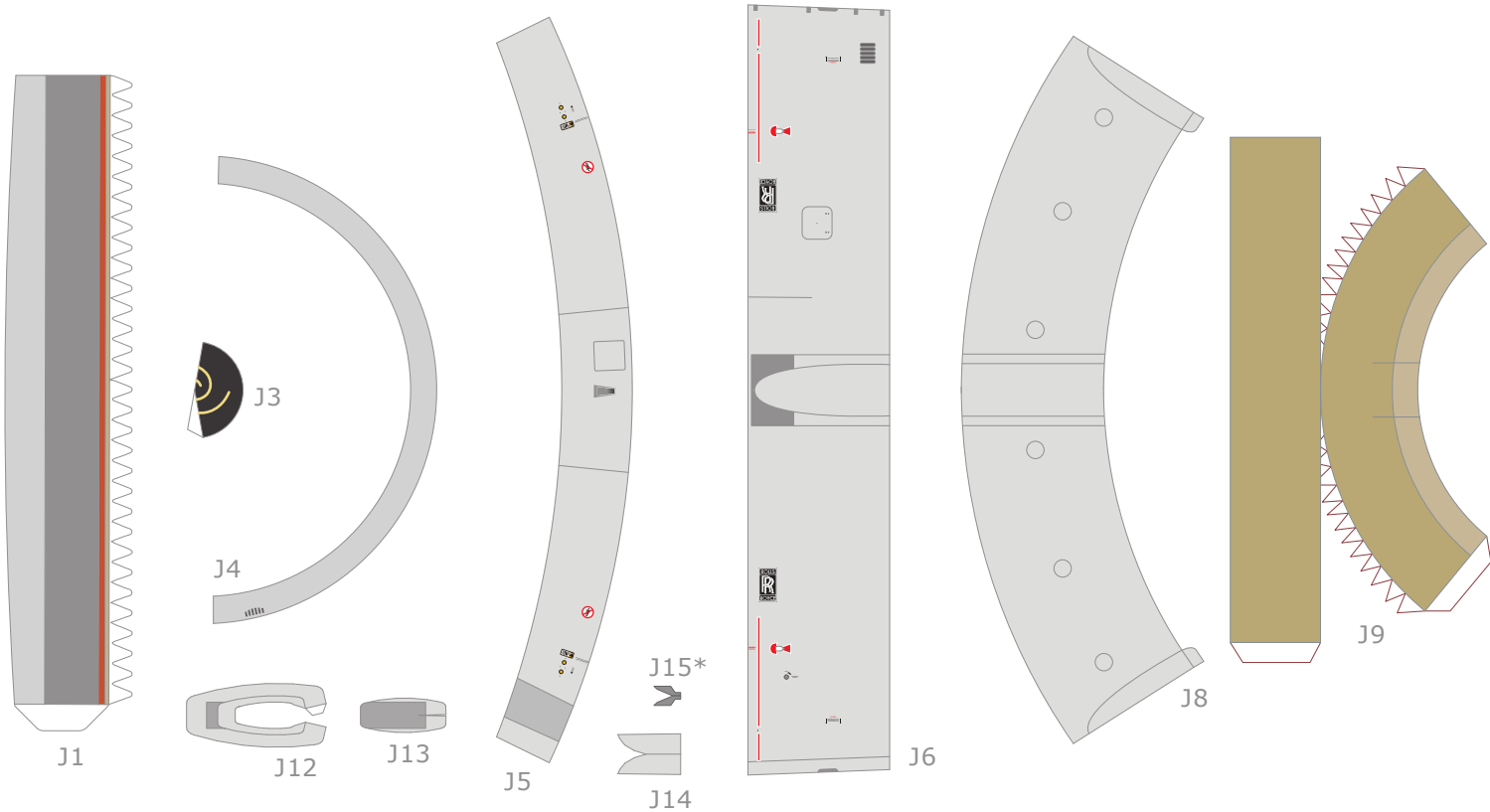
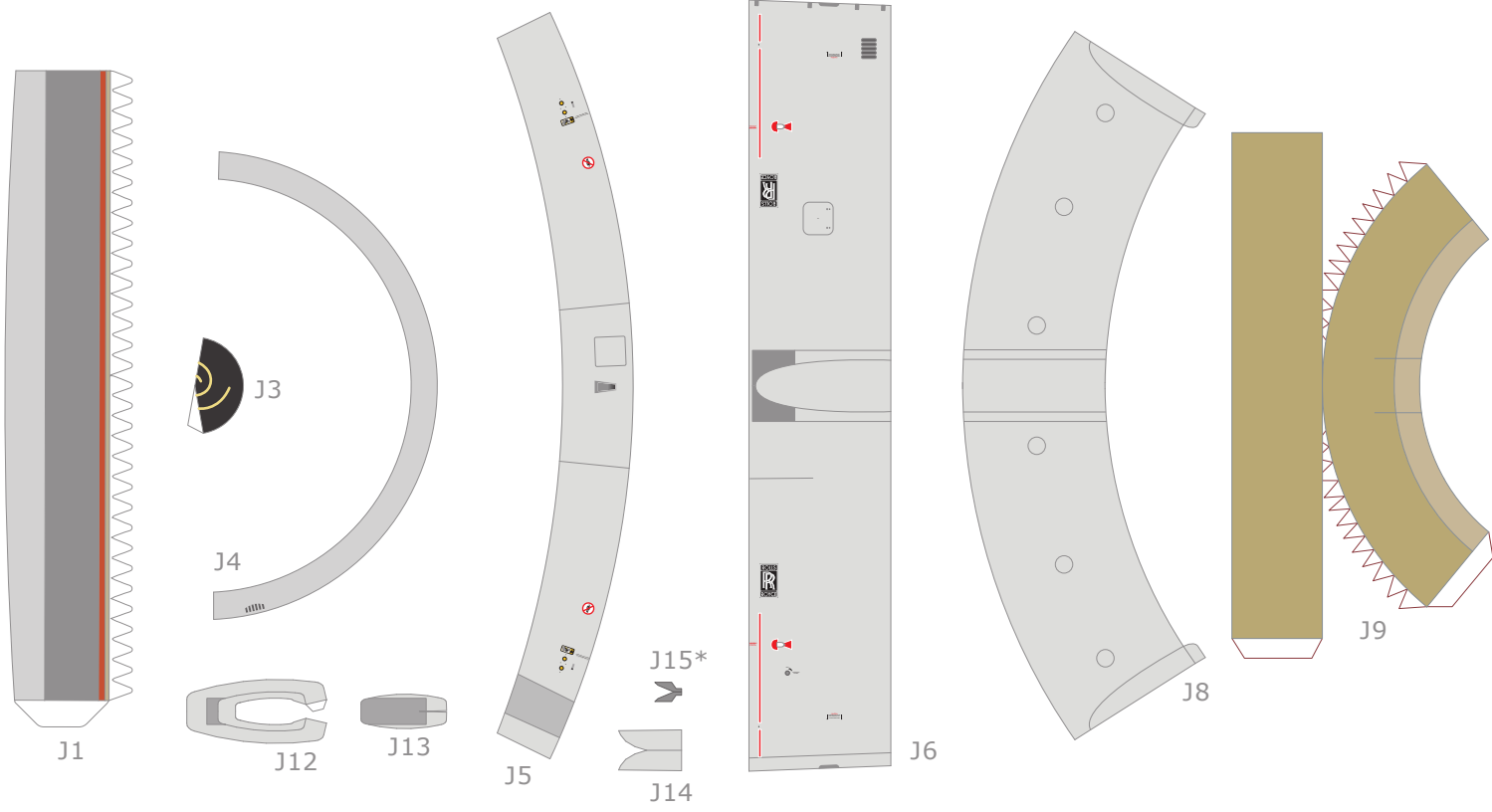

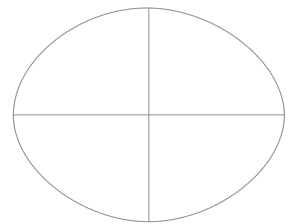
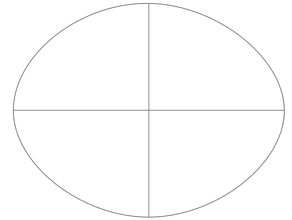
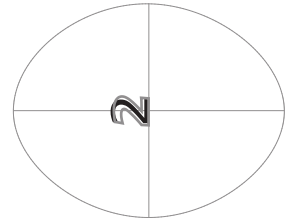
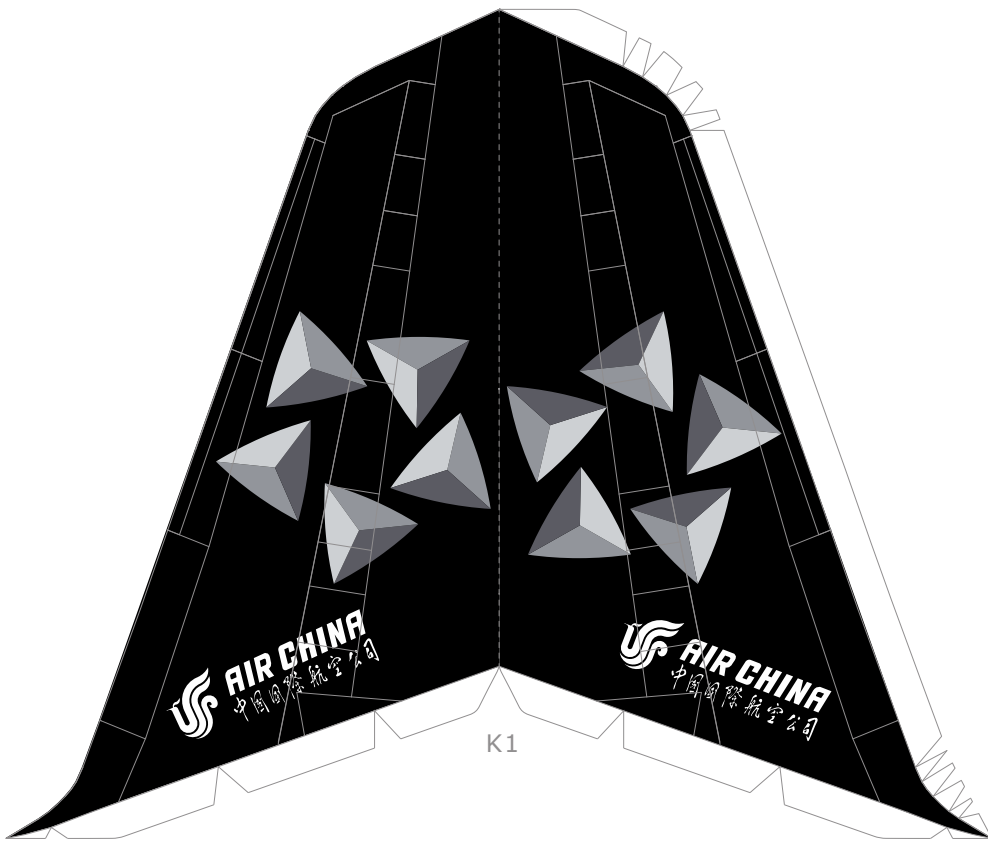

K2

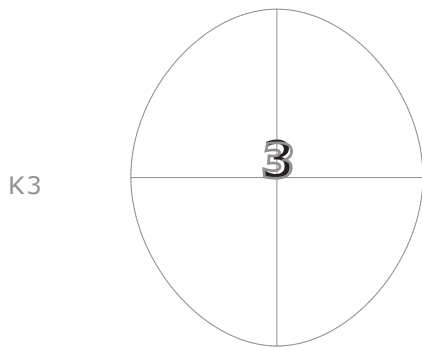

K3

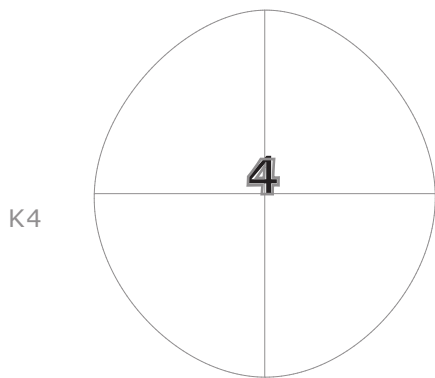
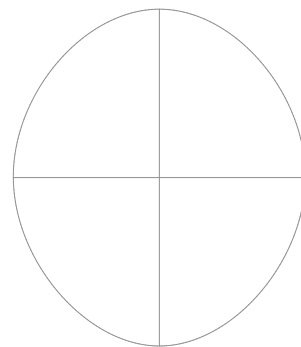
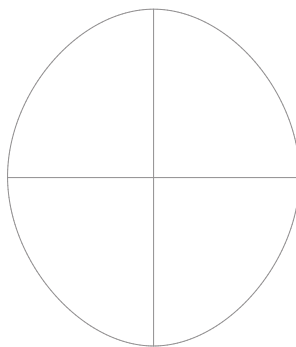

K4

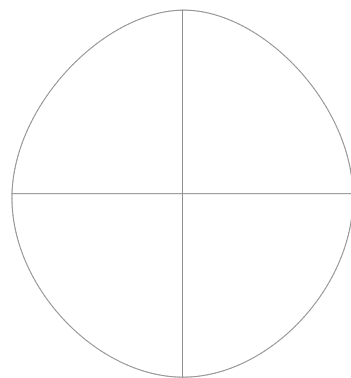
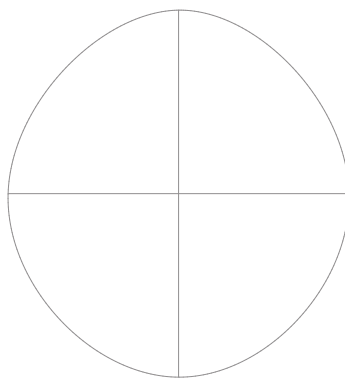

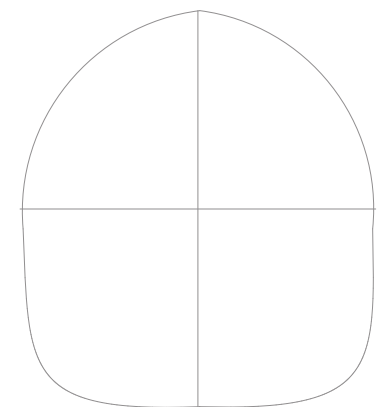
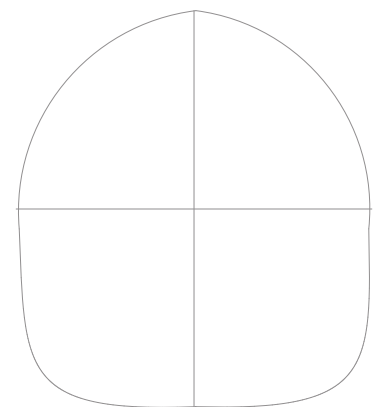
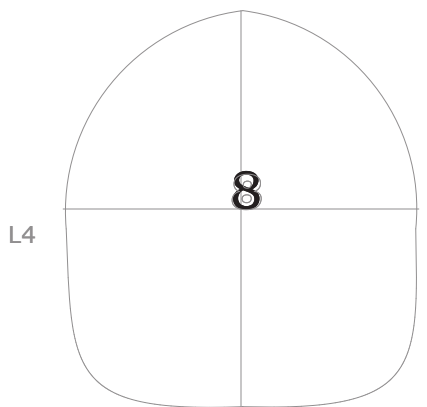
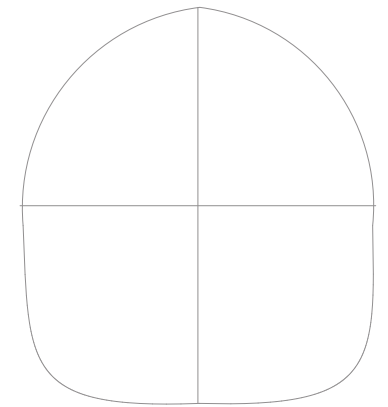
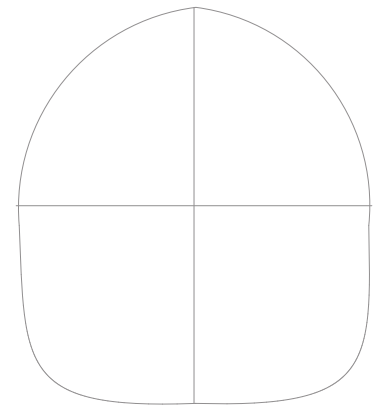
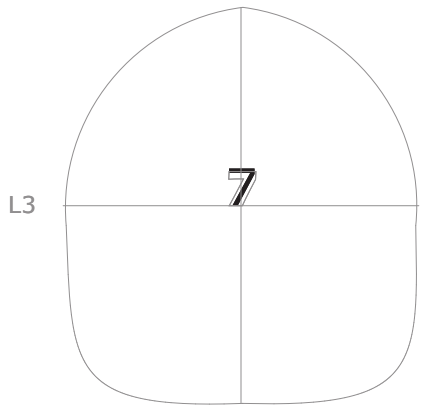
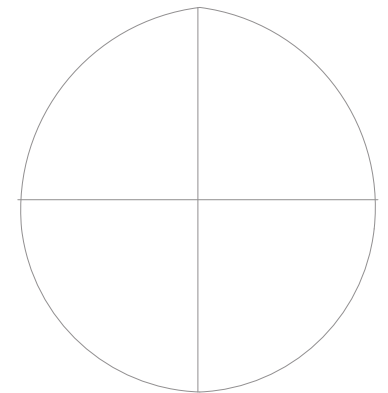
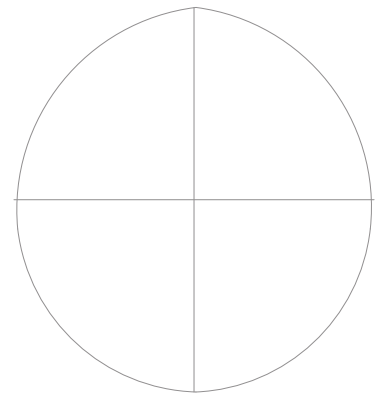
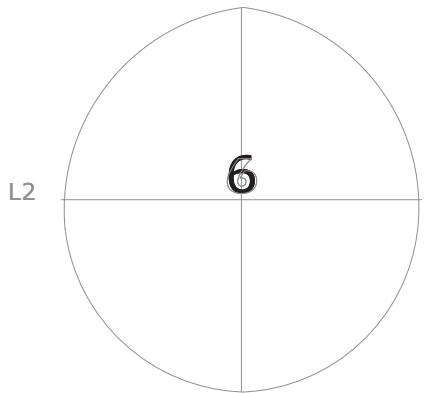
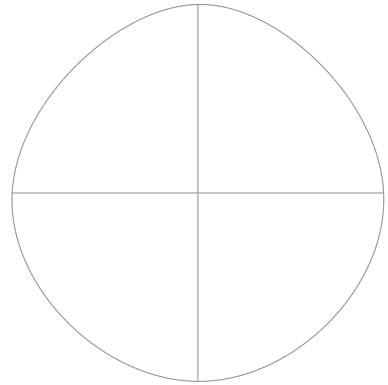
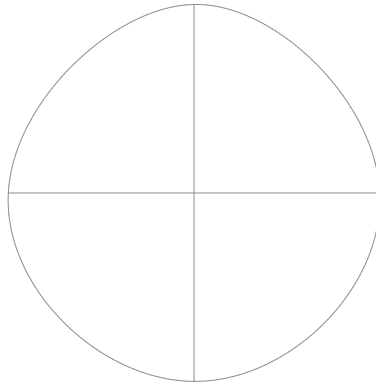
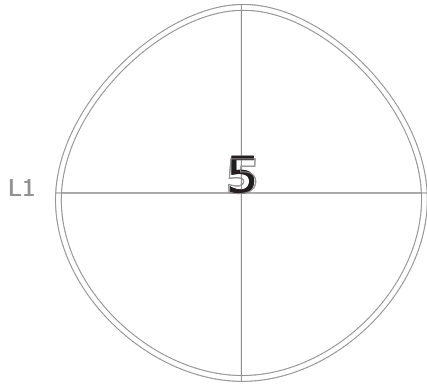

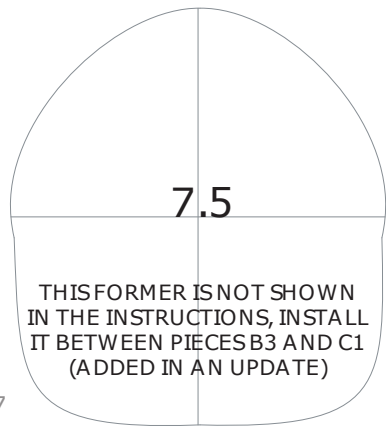

M7

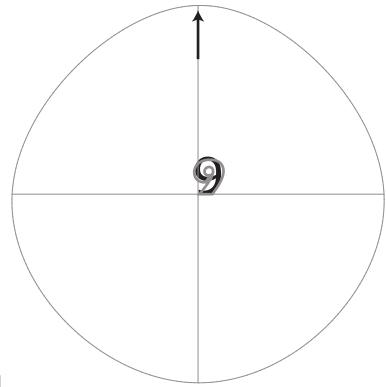
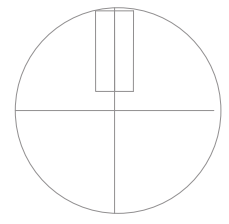
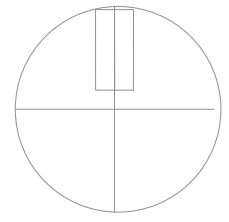
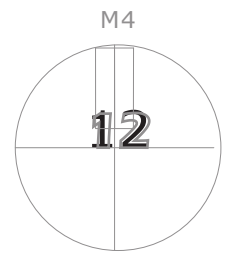
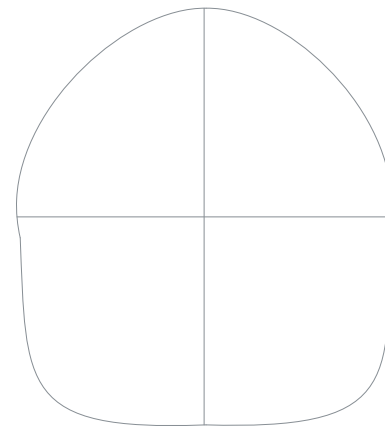
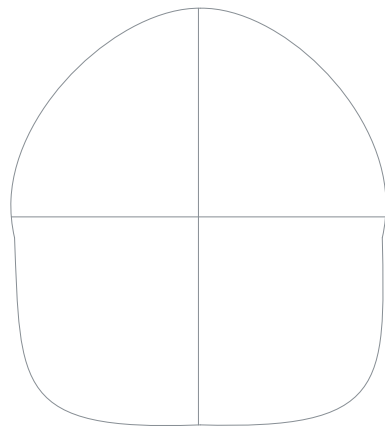

M1

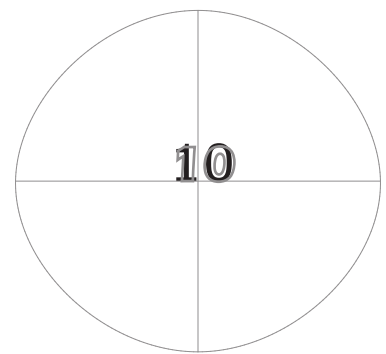
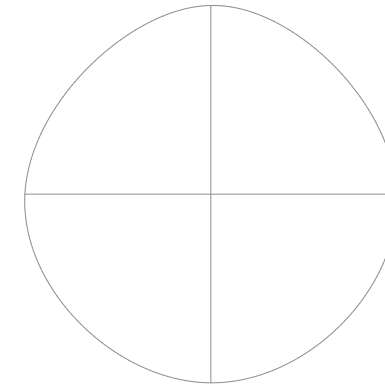
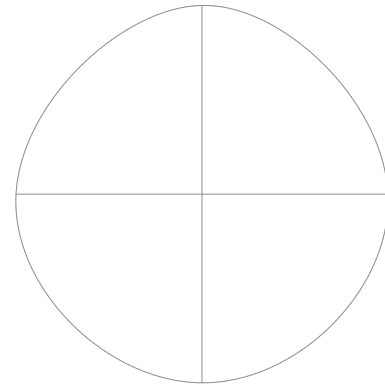

M2

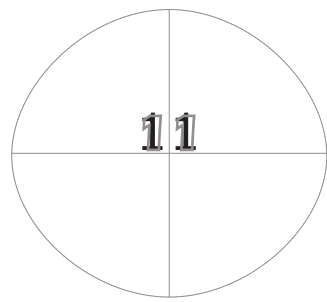
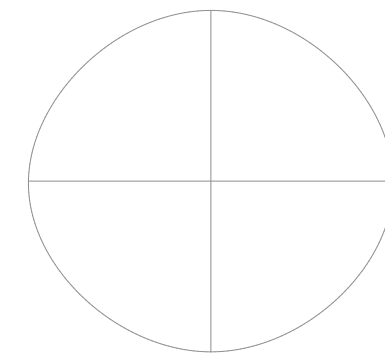
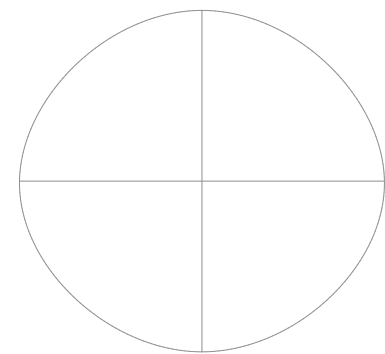

M3

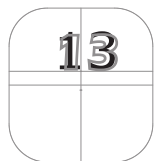
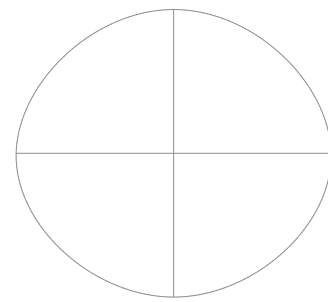
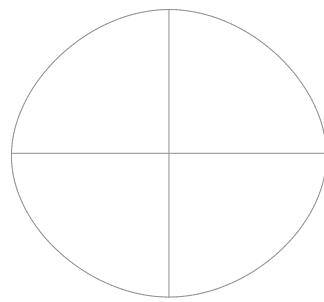

M5

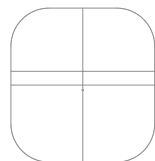
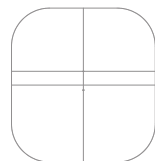

M6

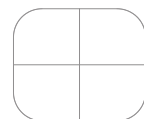
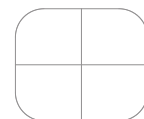

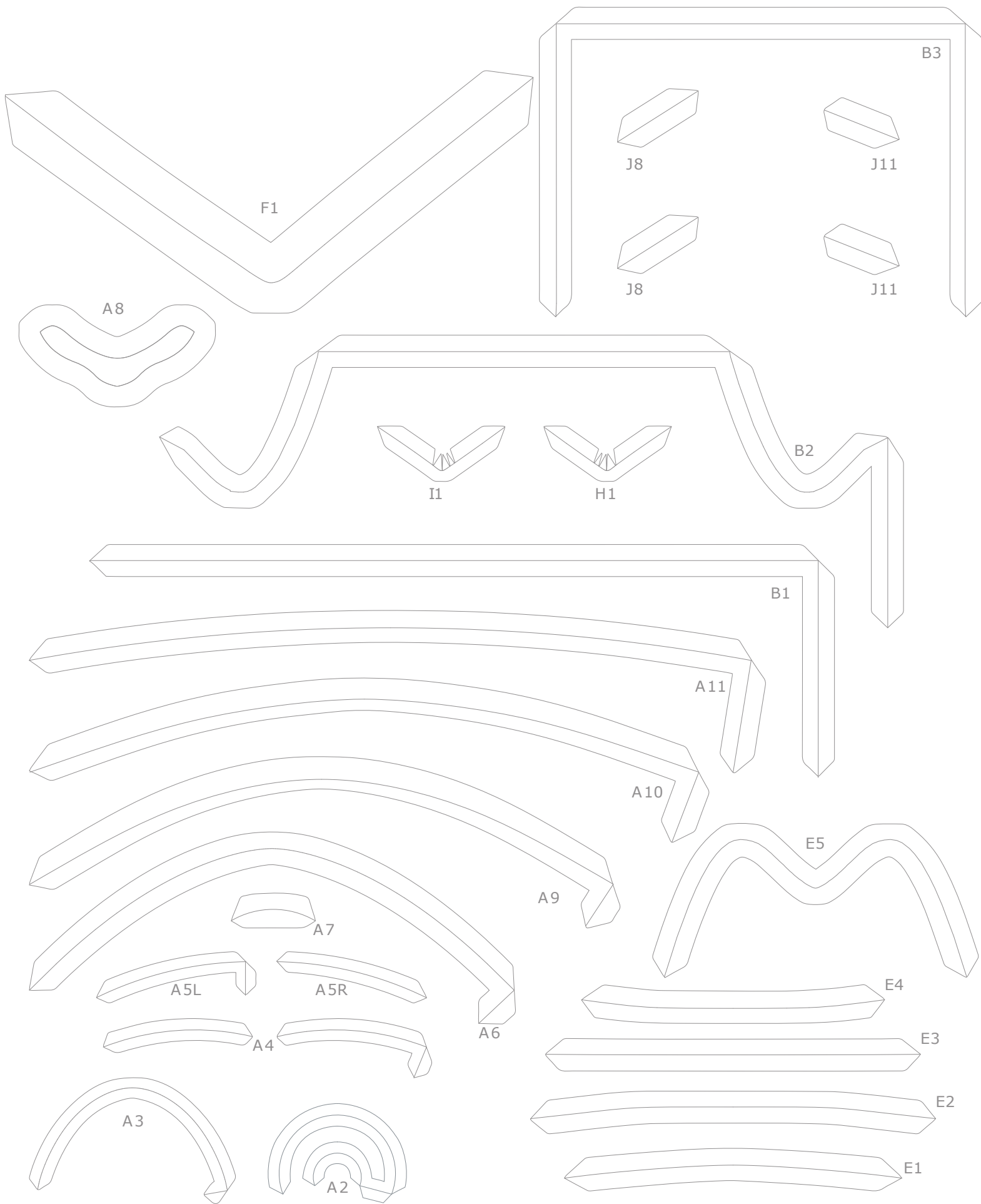

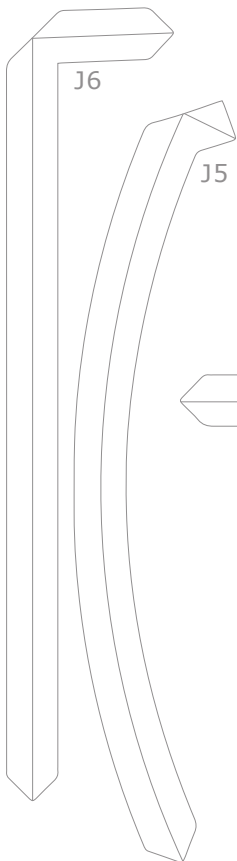
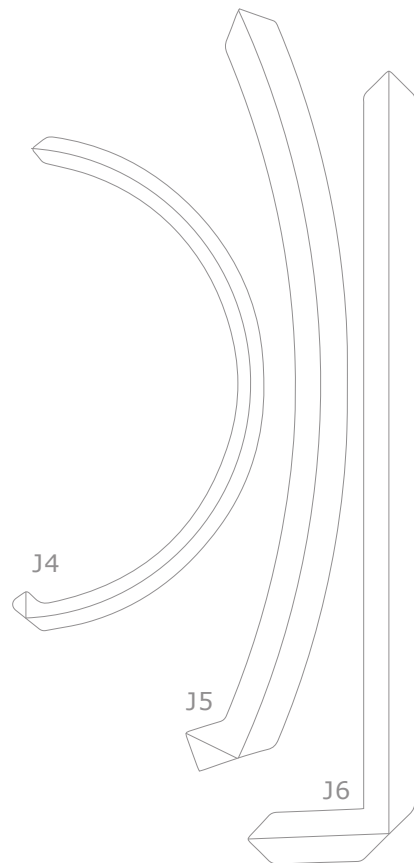
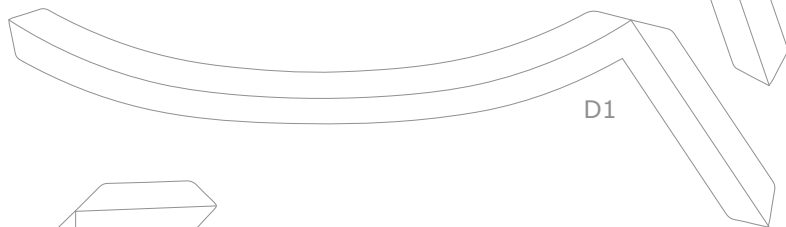
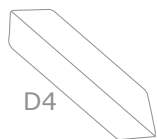
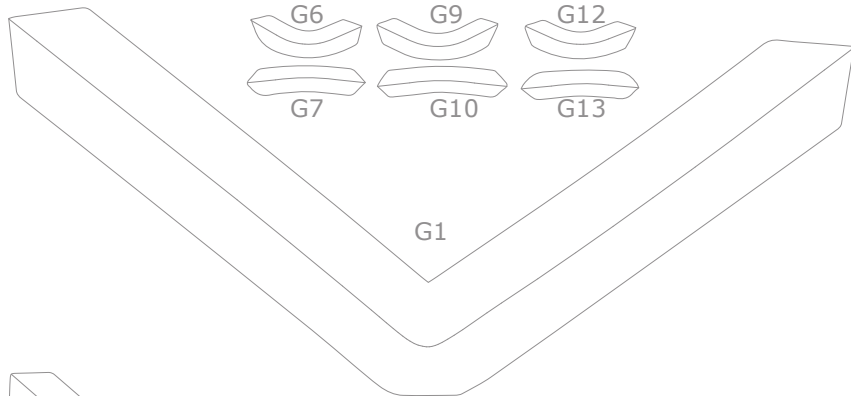
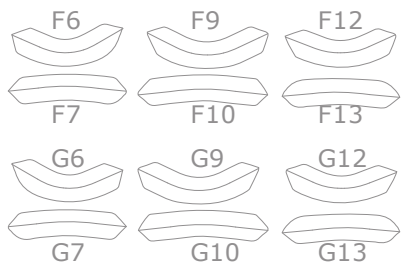

J6

J5



C4

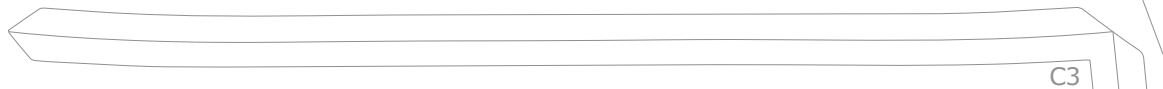

C3

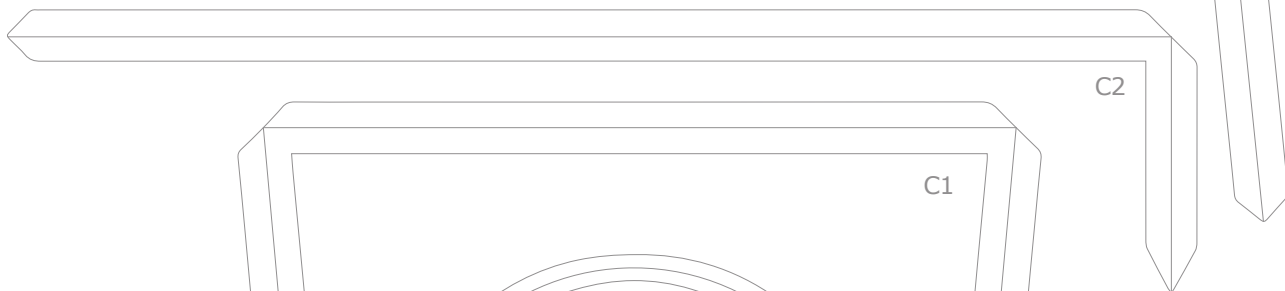

C2

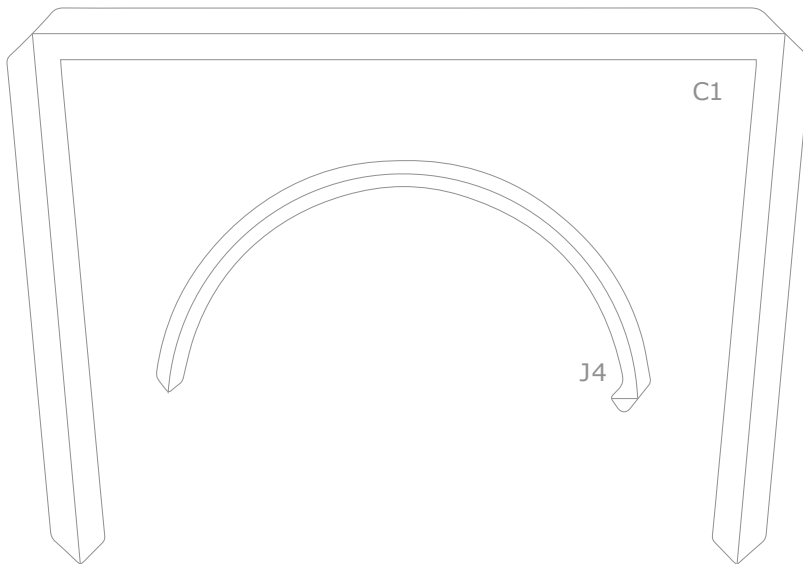

C1

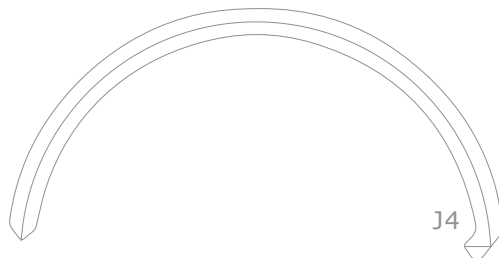

J4

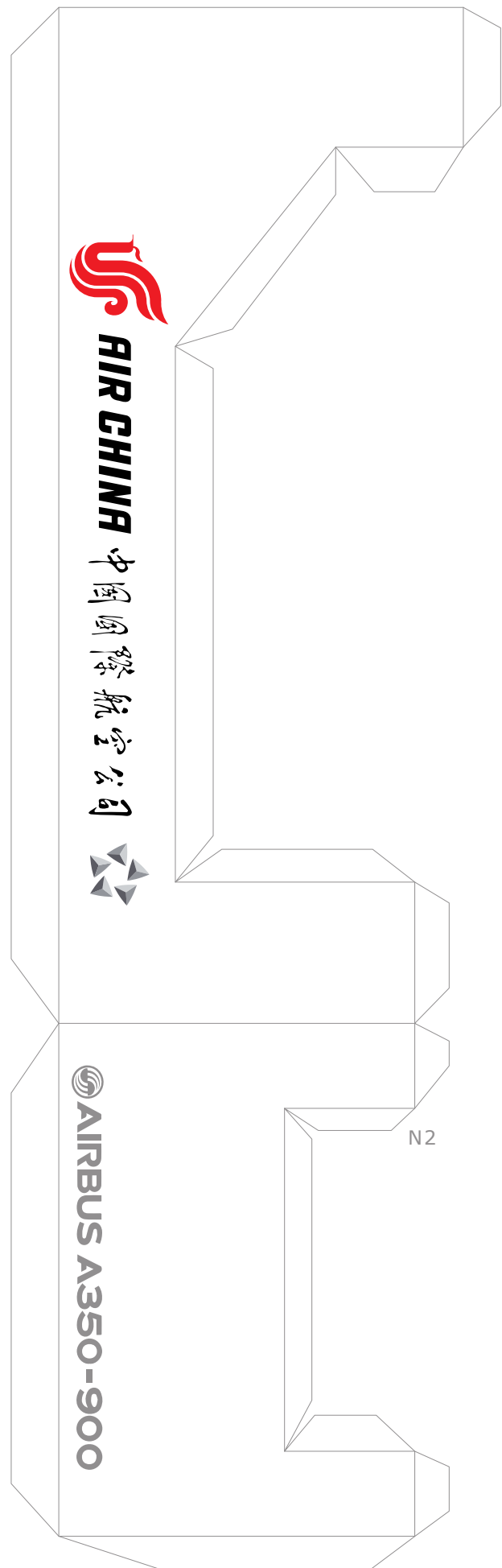
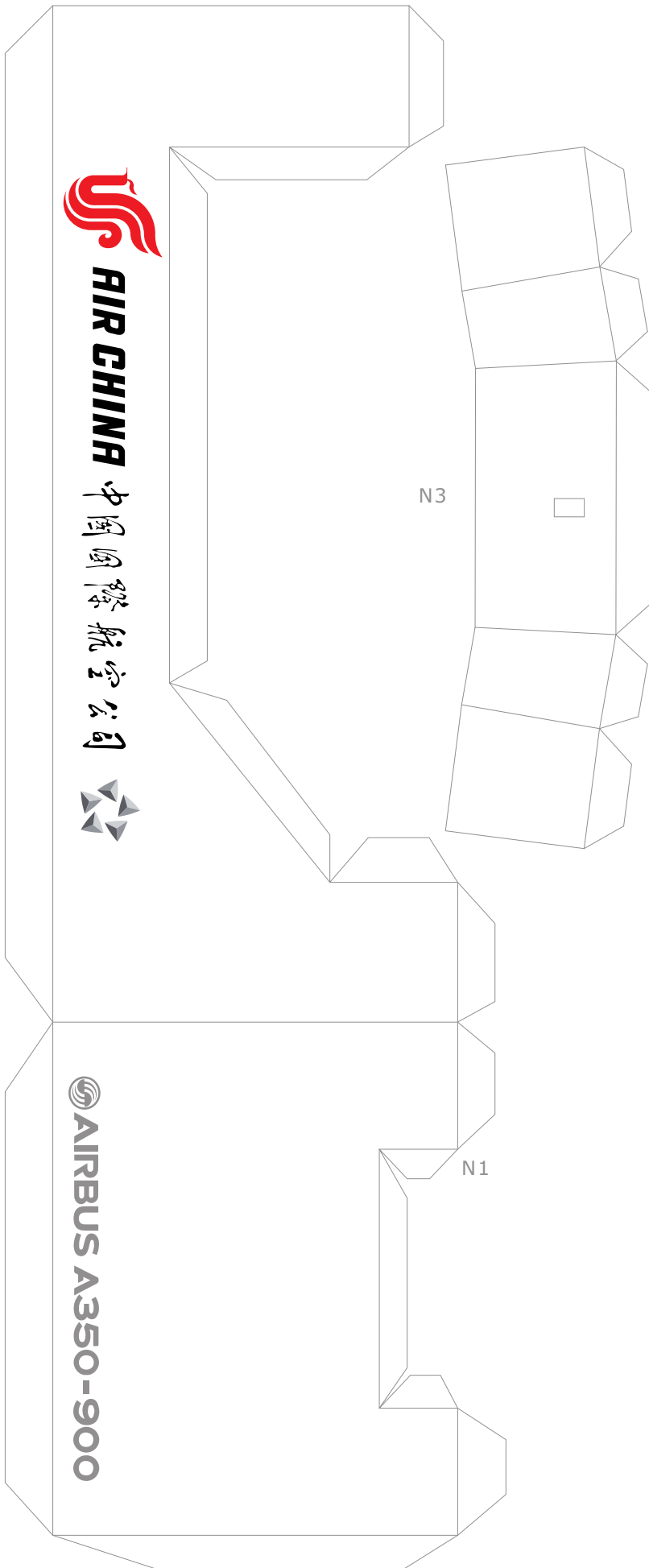



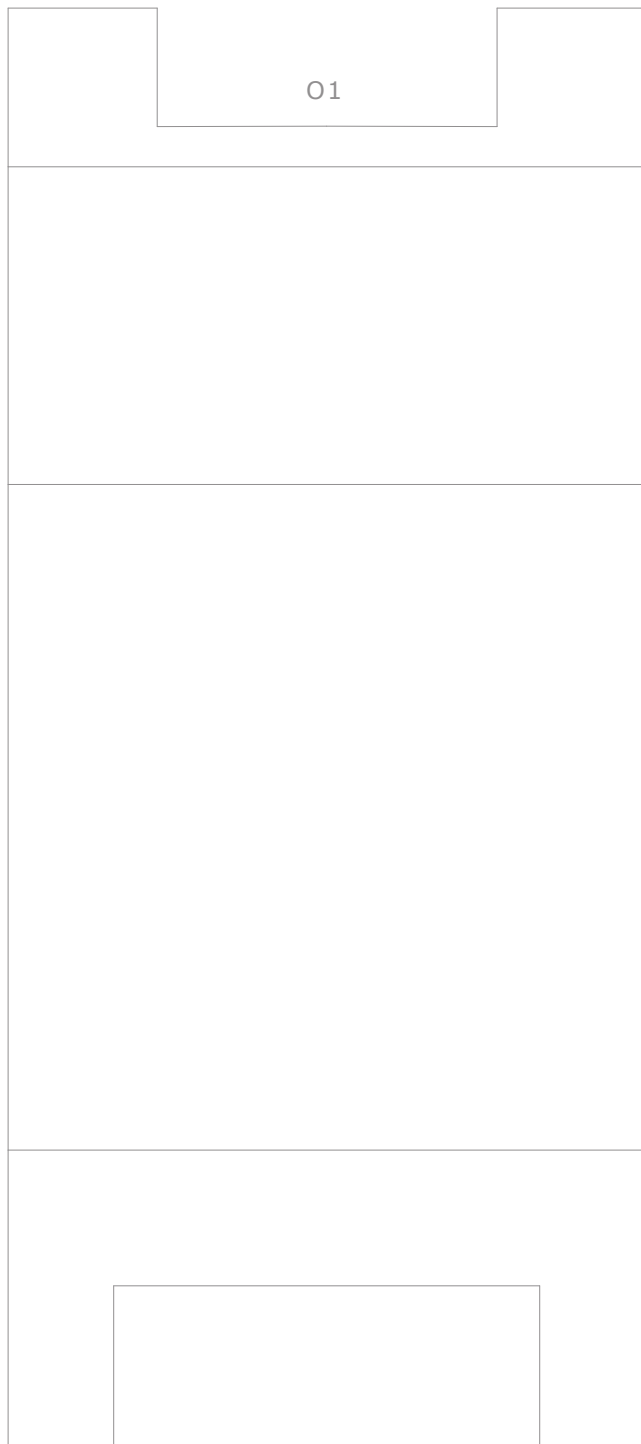

O3

ORIGINAL MODEL DESIGNED BY EDWIN RODRIGUEZ

**HERMERCRAFT**

PLEASE DO NOT SELL THIS FILE | DESIGNED IN PALMARES, COSTA RICA