

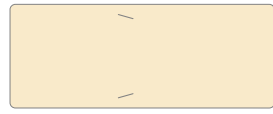

Repaint by: Edwin Rodriguez

© 2020 Edwin Rodriguez

A13\*

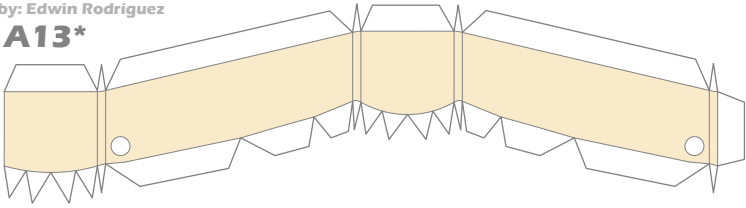

A14\*

A18



A19



A20



A21



A22



A23



A24

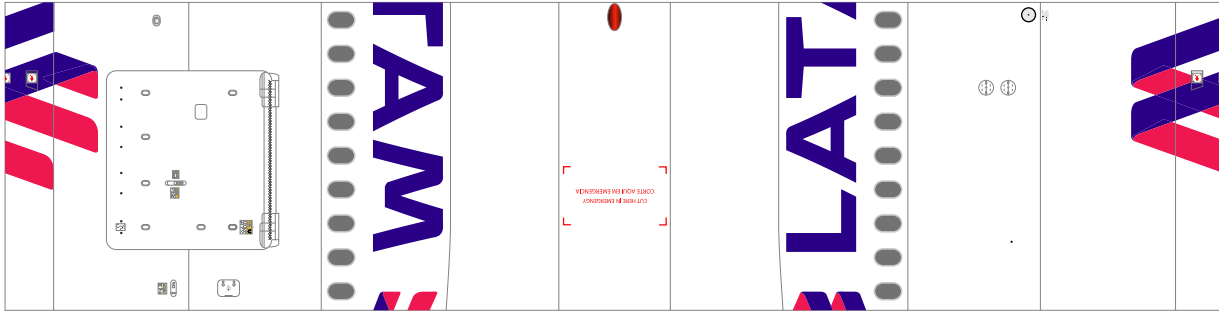

A12

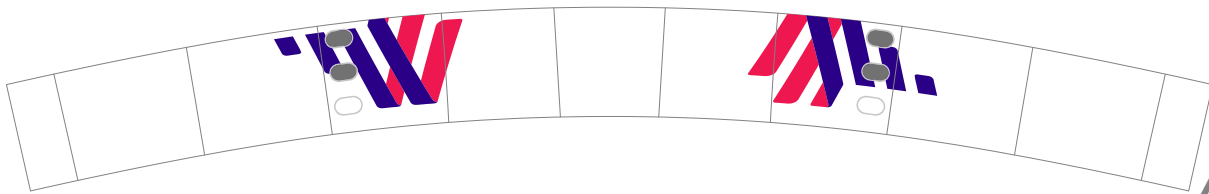

A11

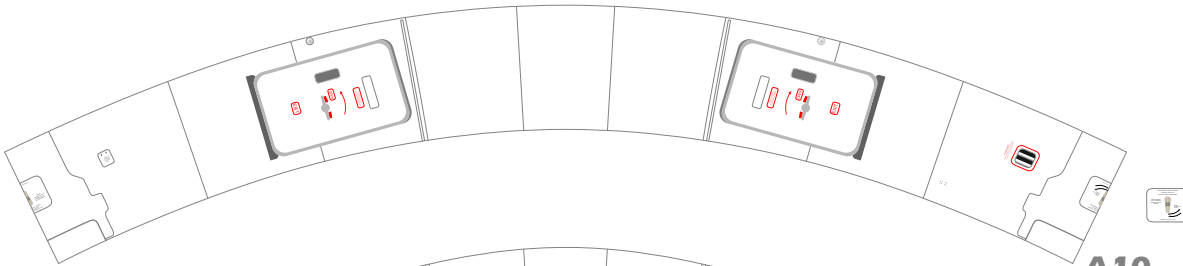

A10

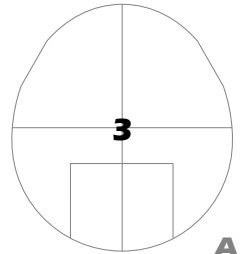
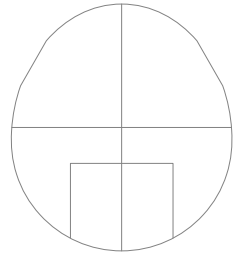
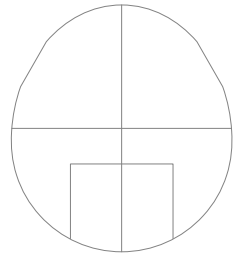

A17

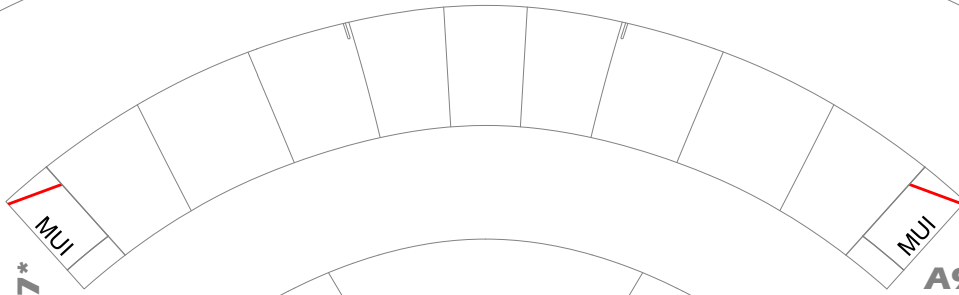

A9

A25\*



A27\*



A26\*

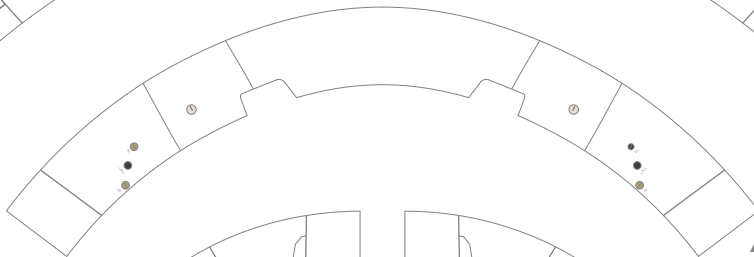

A8

A7R

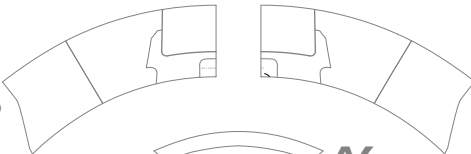

A7L

A6



A5

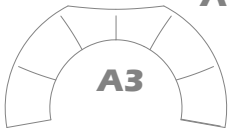
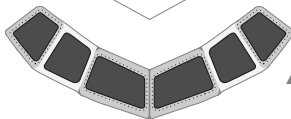

A3



A2

A1

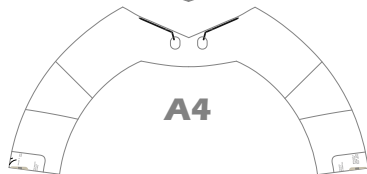

A4

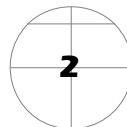

2

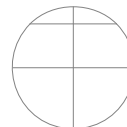

1

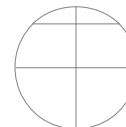

A16



A15

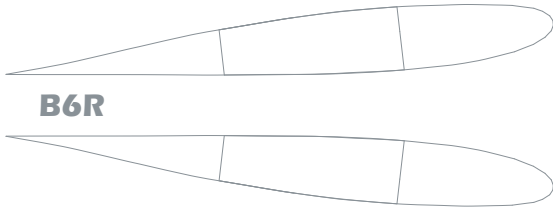

B6R

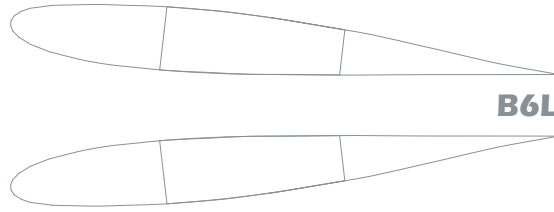

B6L

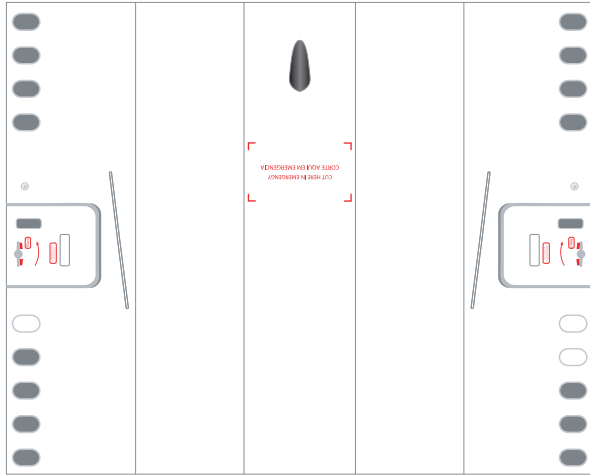

B3

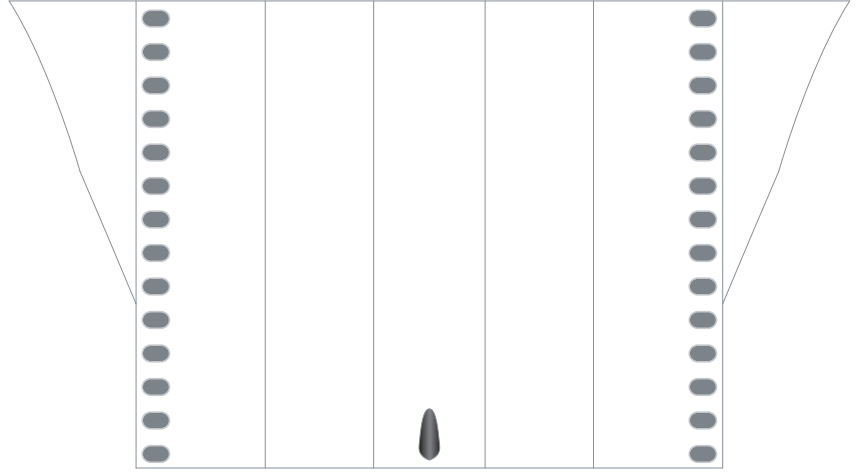

B4

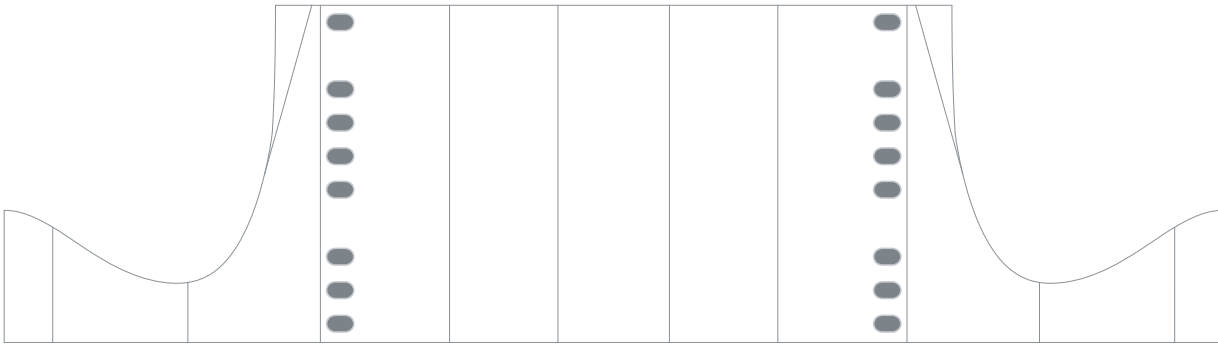

B2

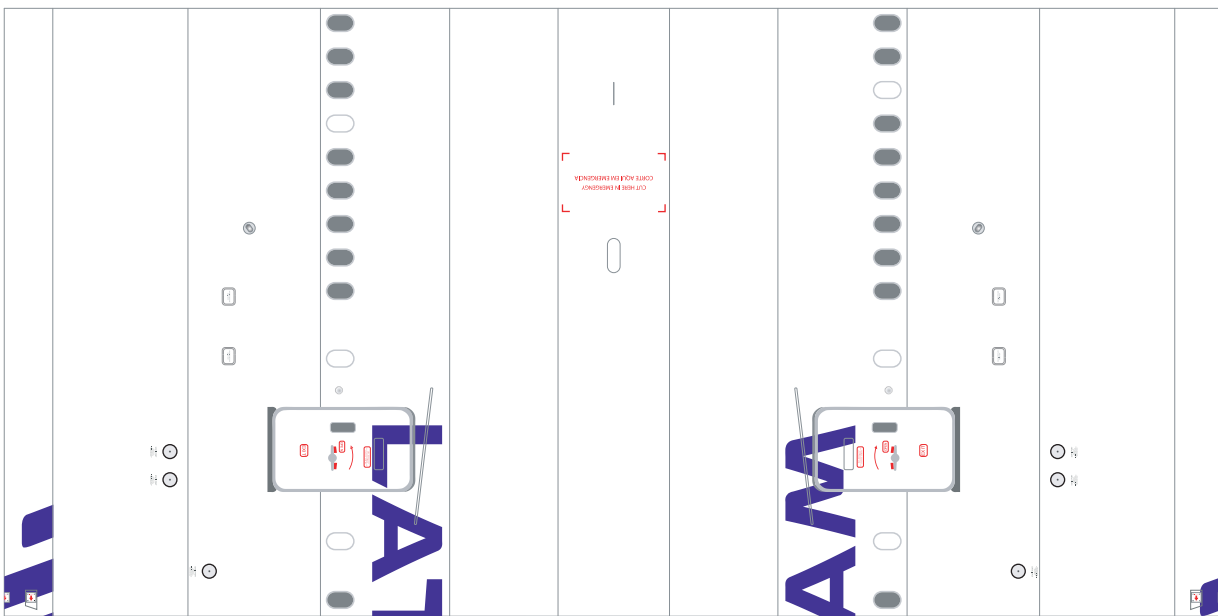

B1



B5

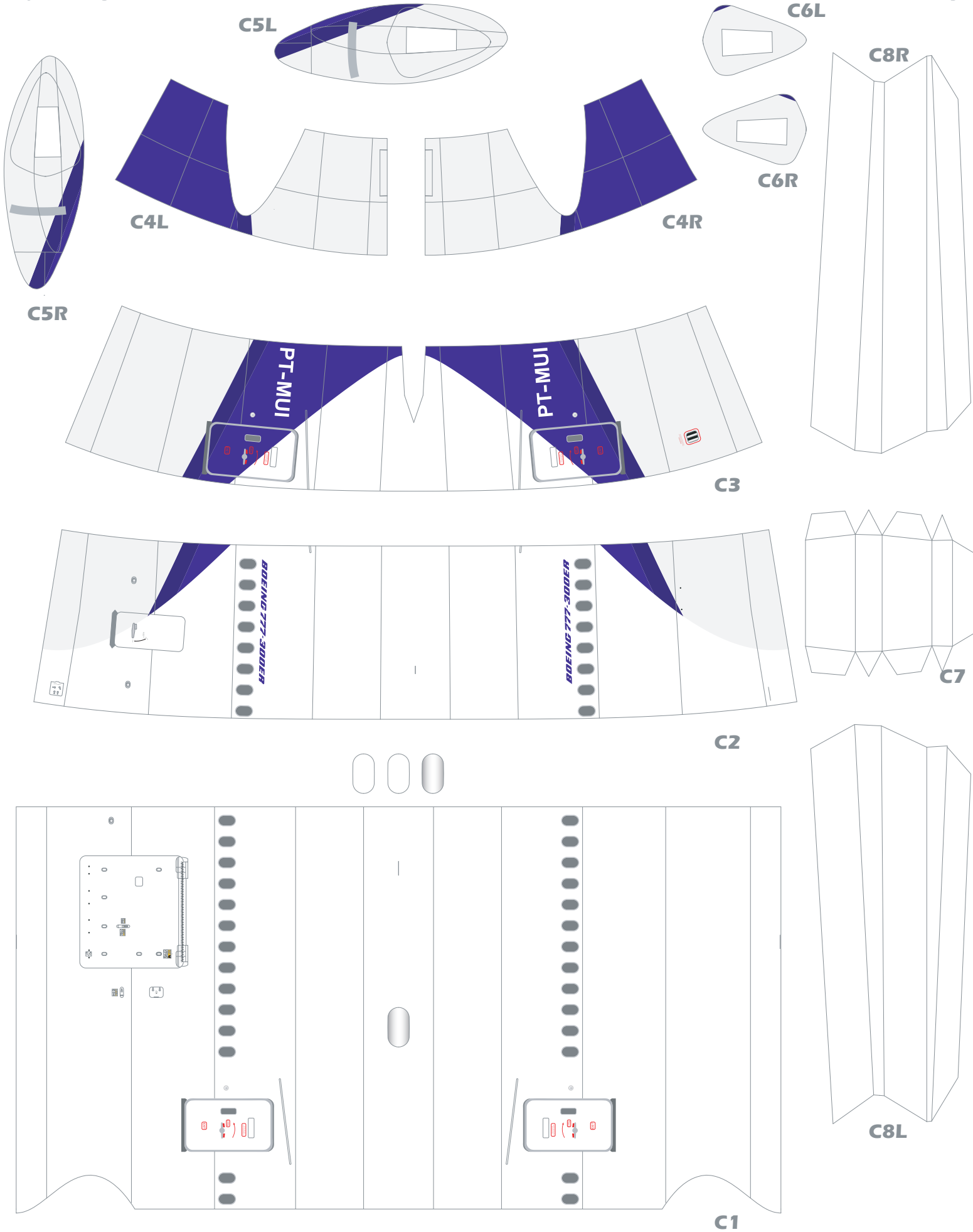



D14R\* D14L\*

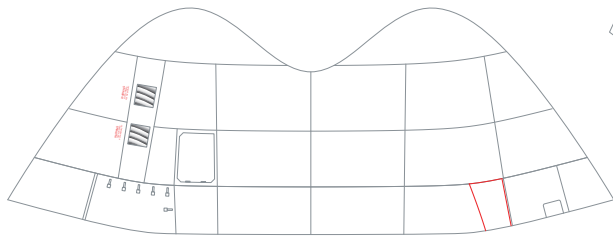
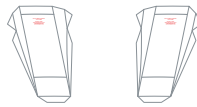

D5

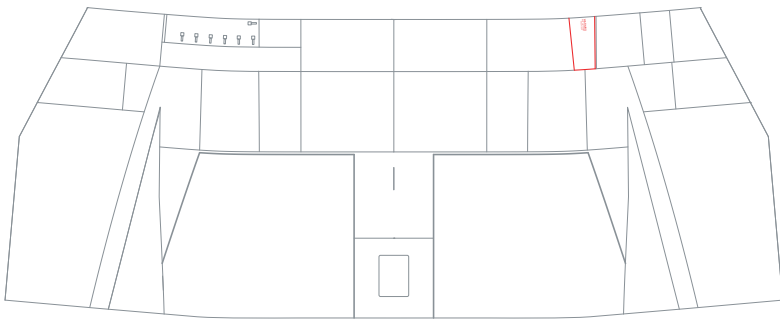

D4

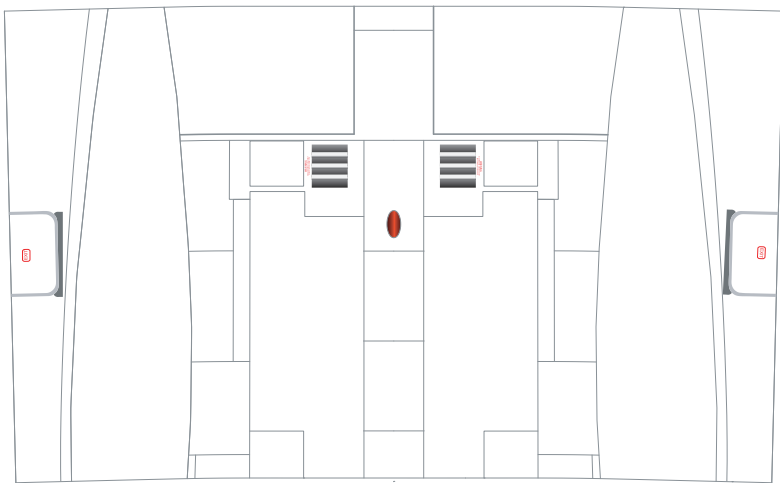

D3



D2

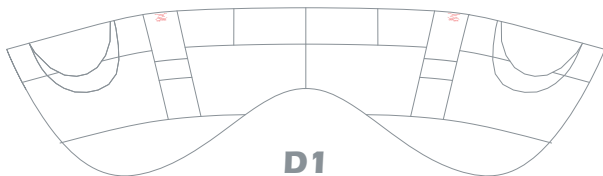

D1

D12L

D12R

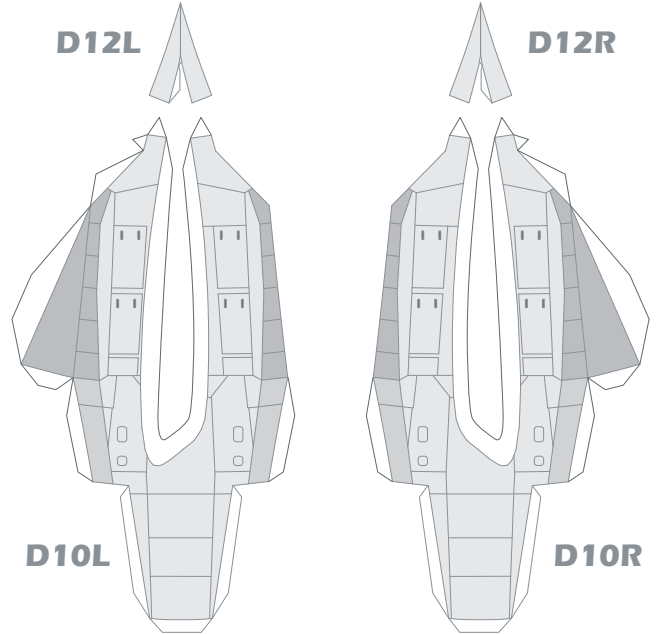

D10L

D10R

D11L

D11R

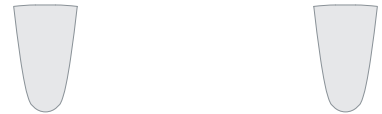

D12\*



D13\*



D9

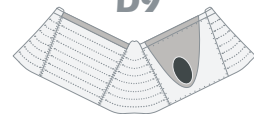

D8

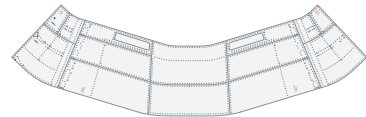

D15\*

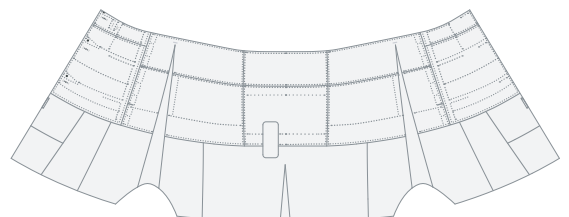

D7

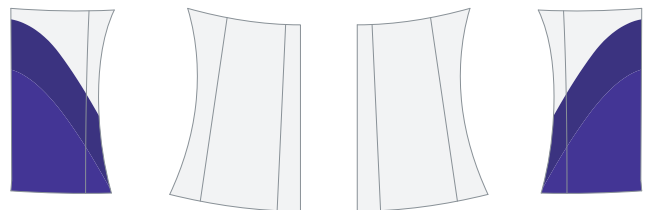

D6L

D6CL

D6CR

D6R

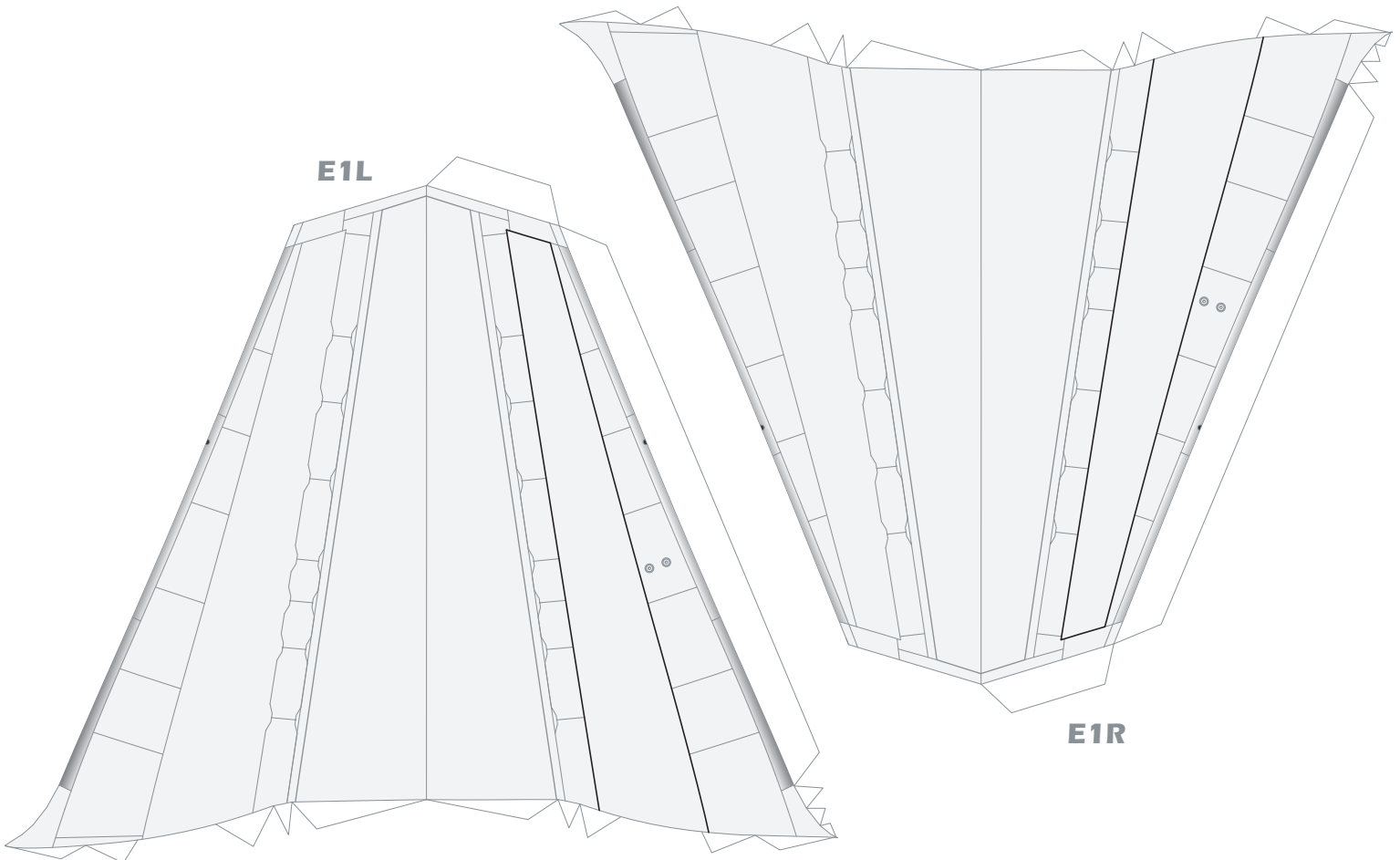
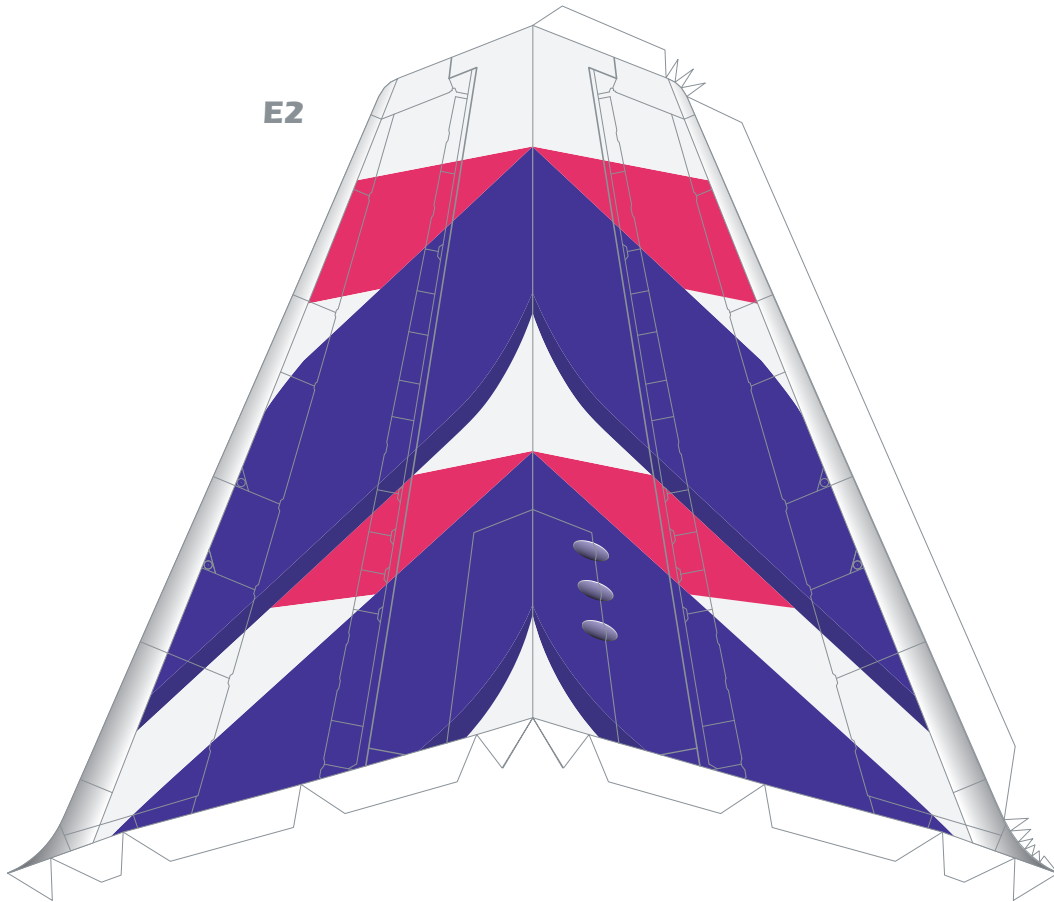

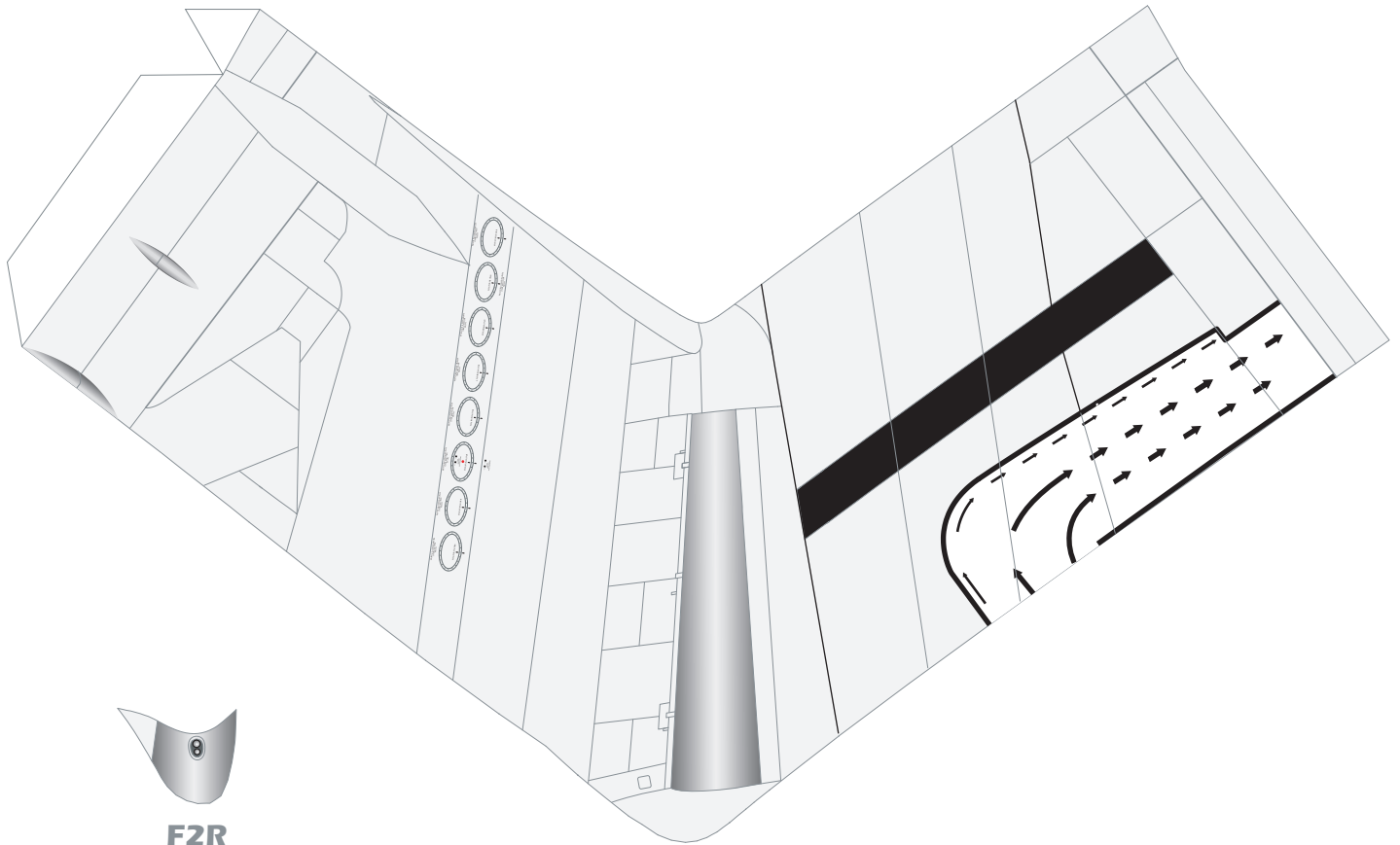

F2R

F1R

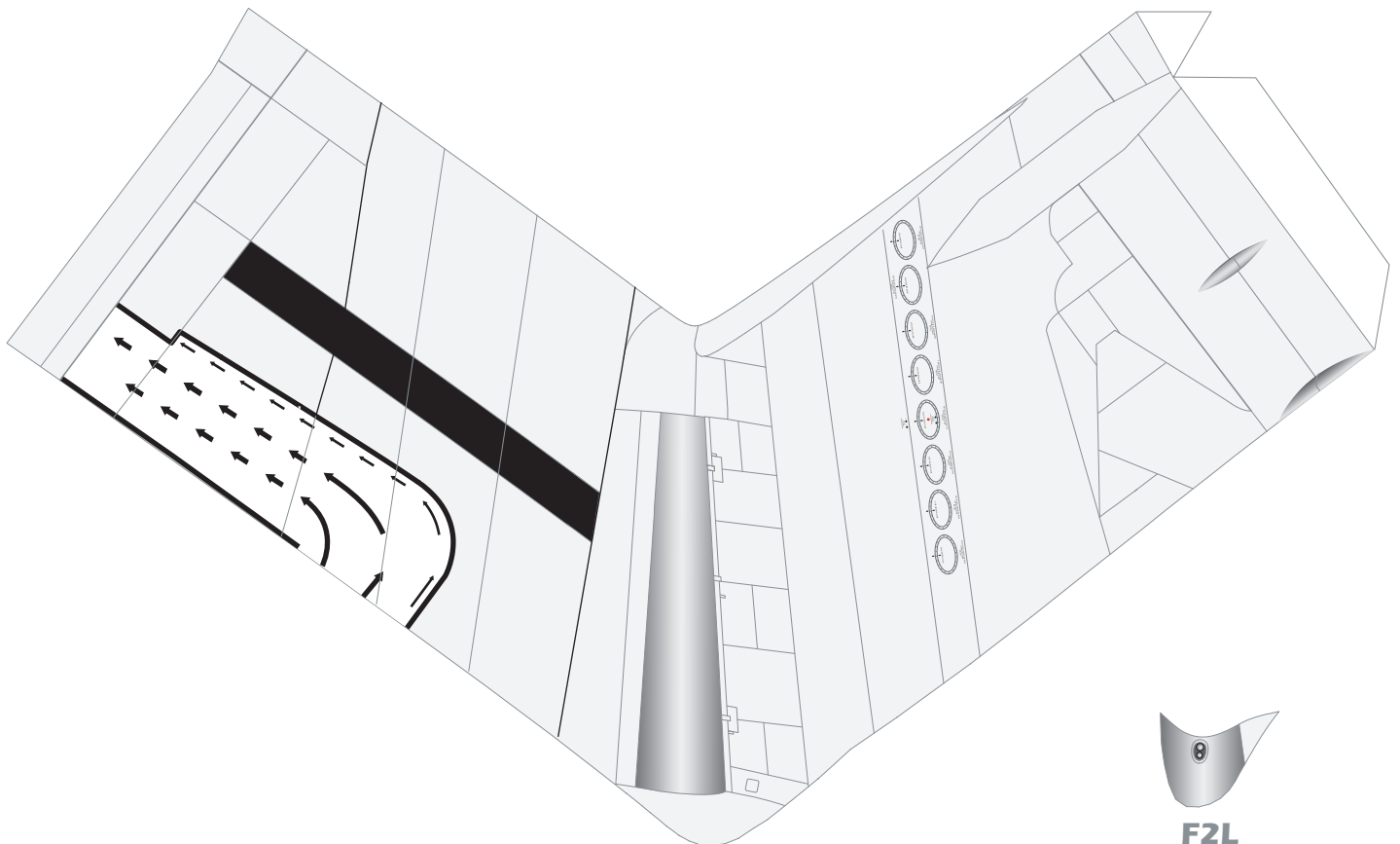

F2L

F1L

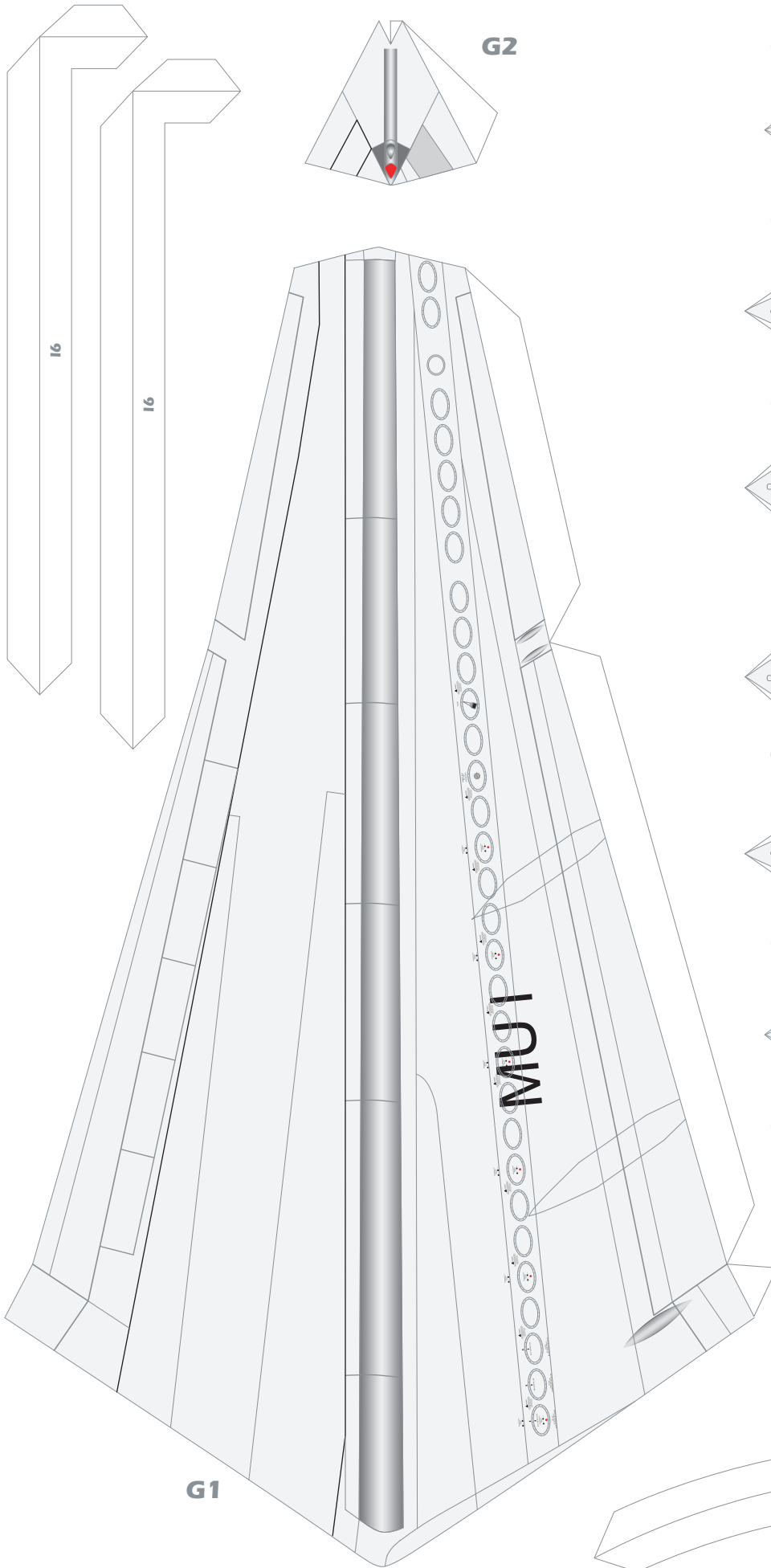

G1

G2

G9R

G10R

G11R

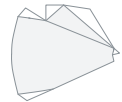
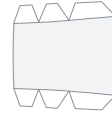

G6R

G7R

G8R

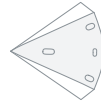

G3R

G4R

G5R

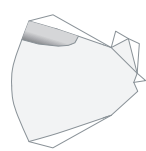
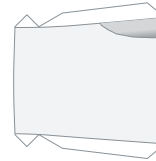

G3L

G4L

G5L

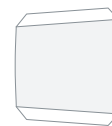

G6L

G7L

G8L

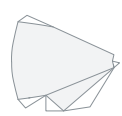

G9L

G10L

G11L

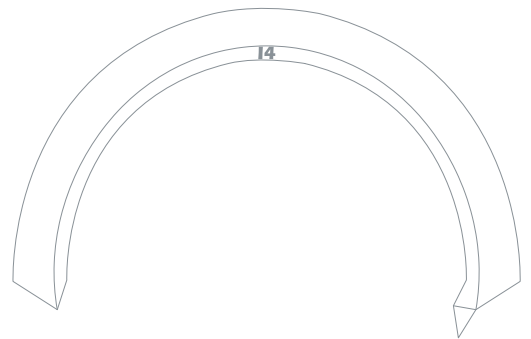

14

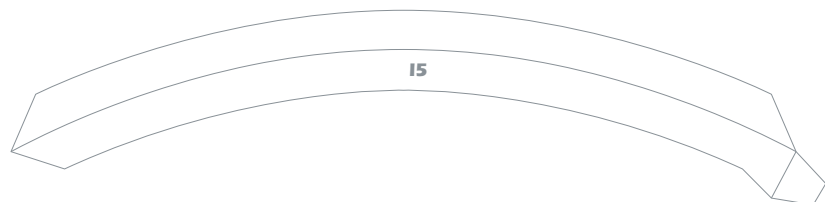

15

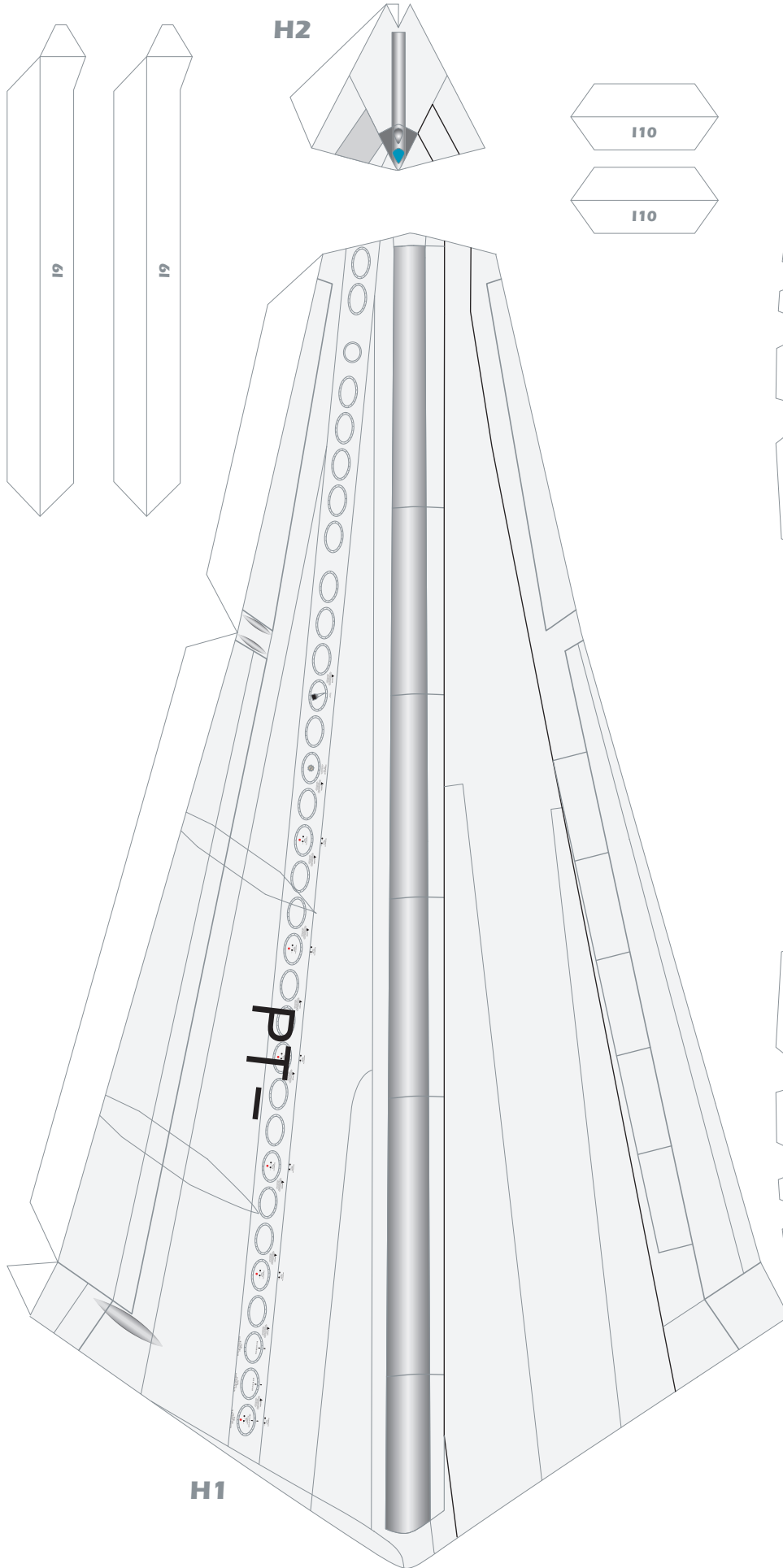

**H4R**

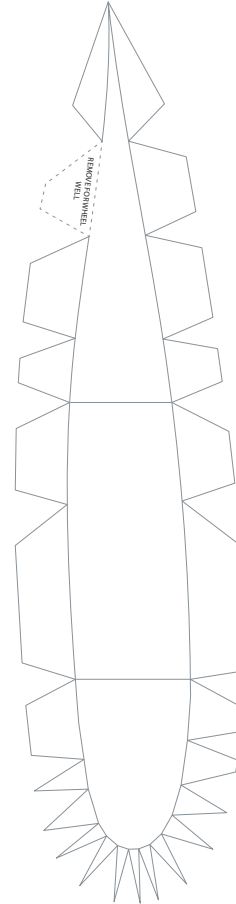

**H3R**

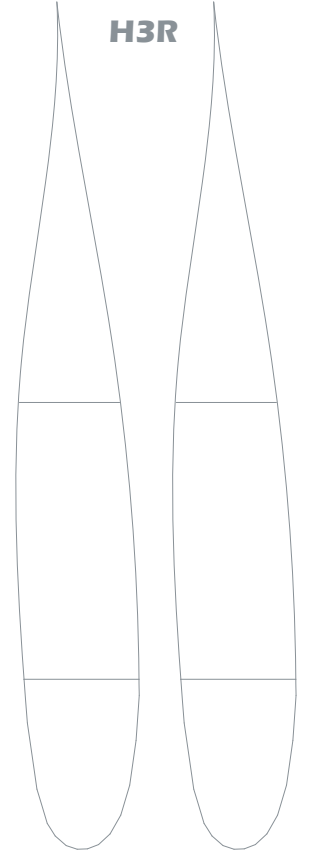

**H4L**

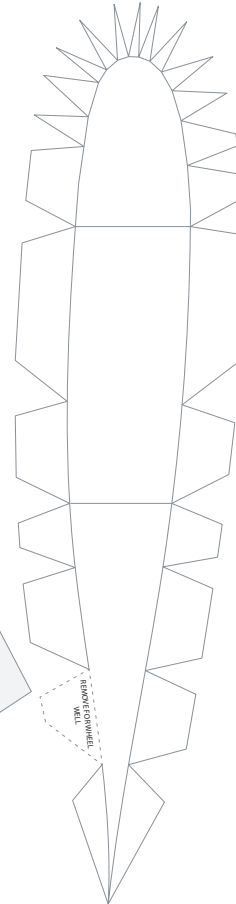

**H3L**

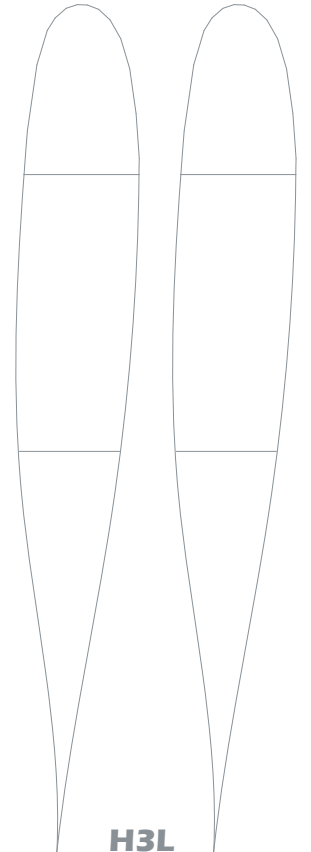



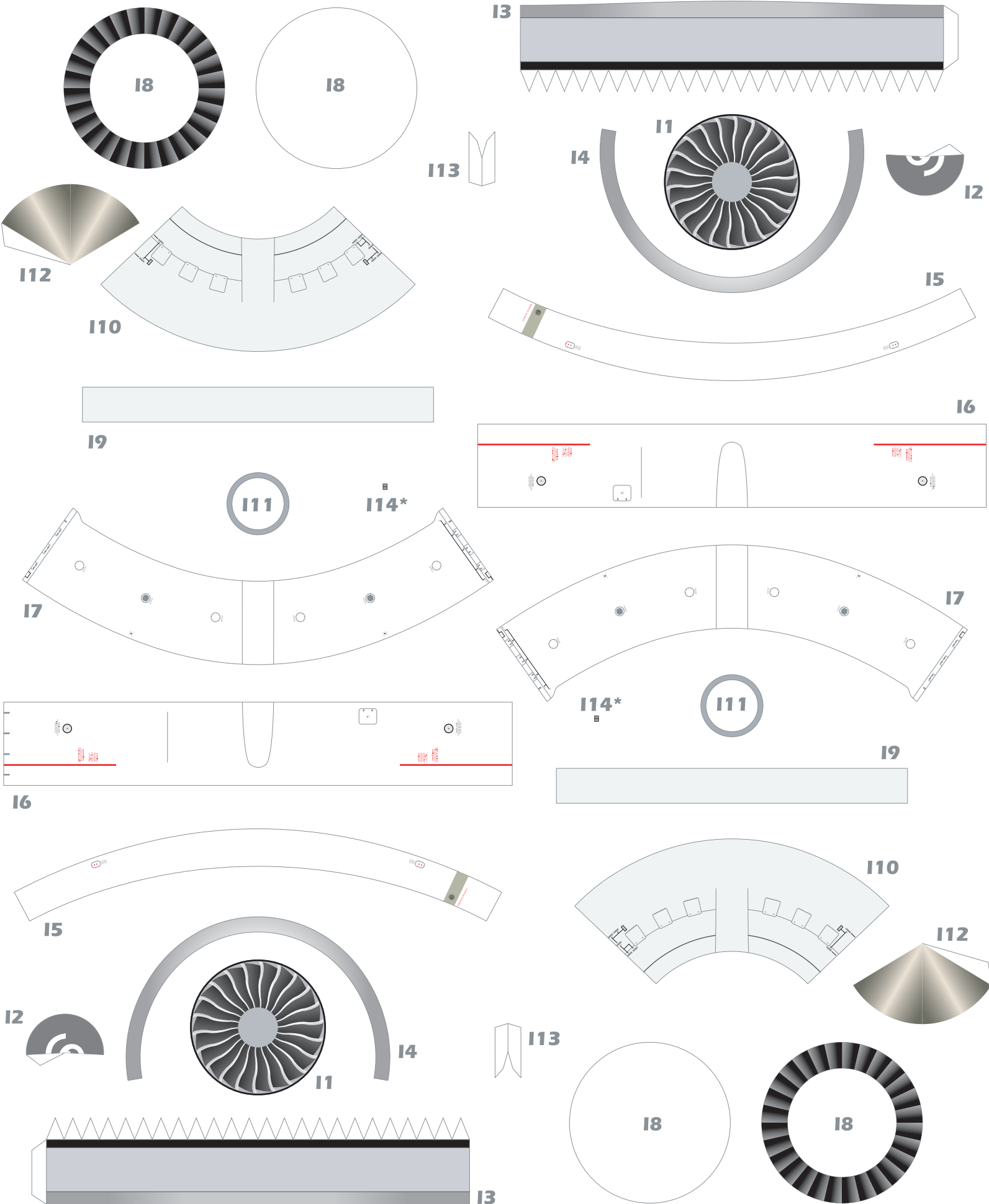

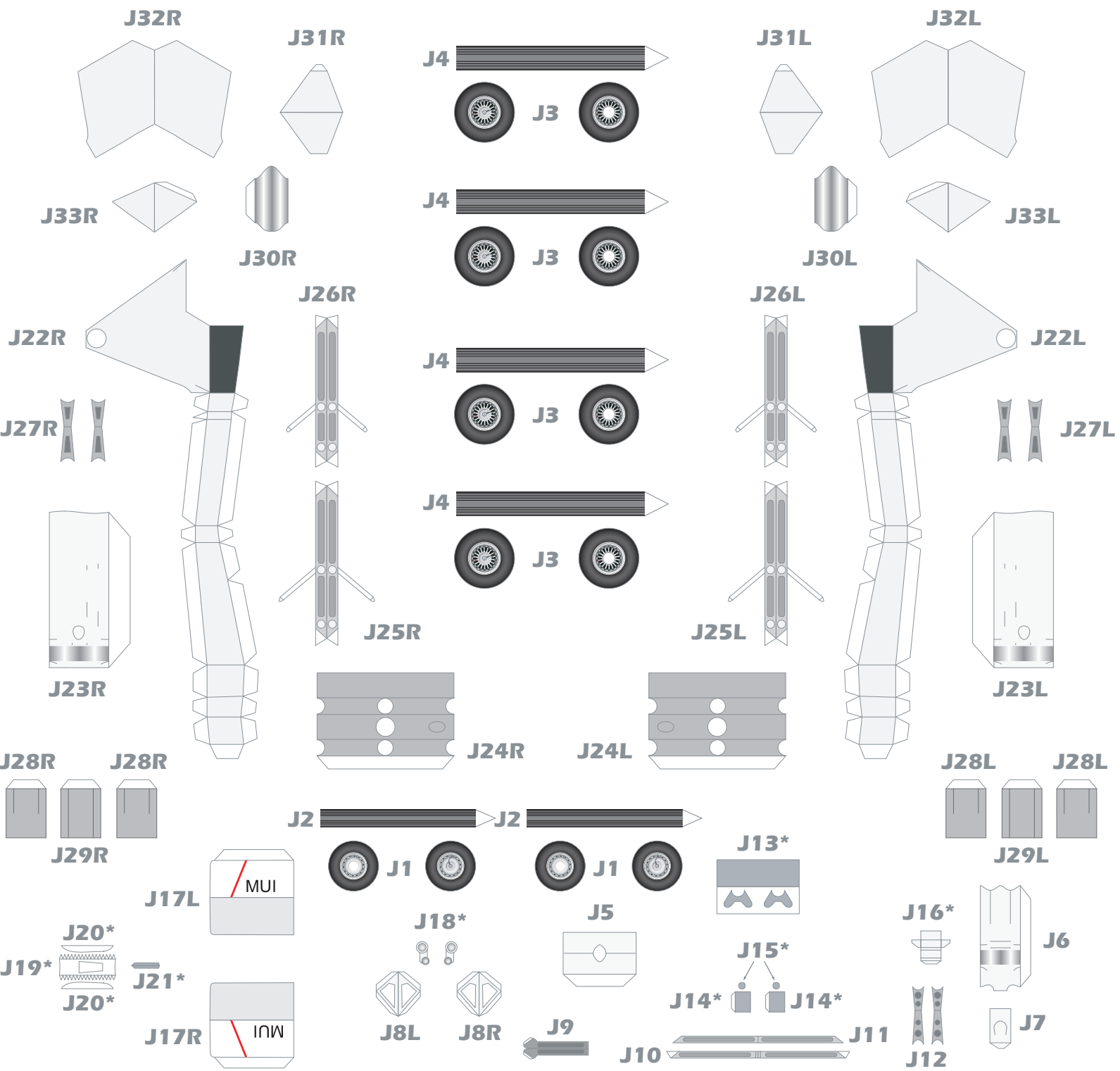
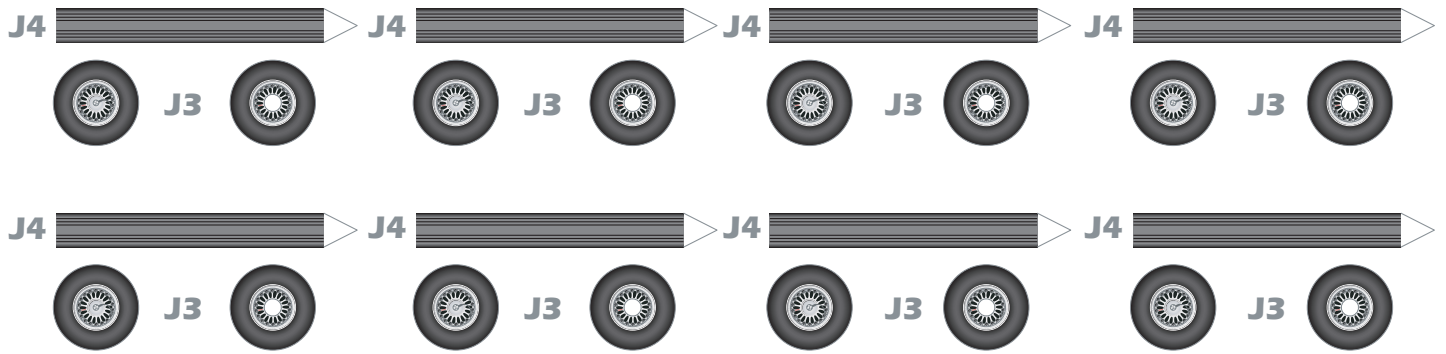

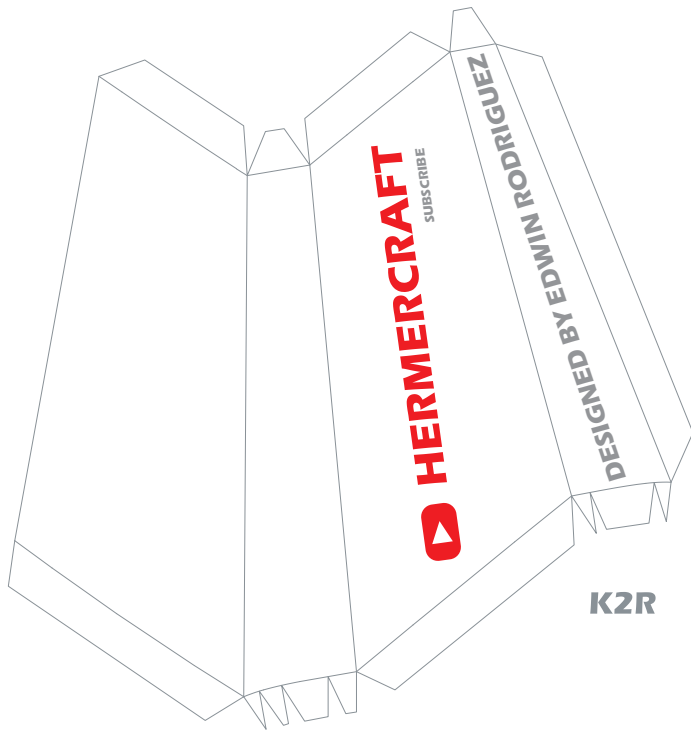

K2R

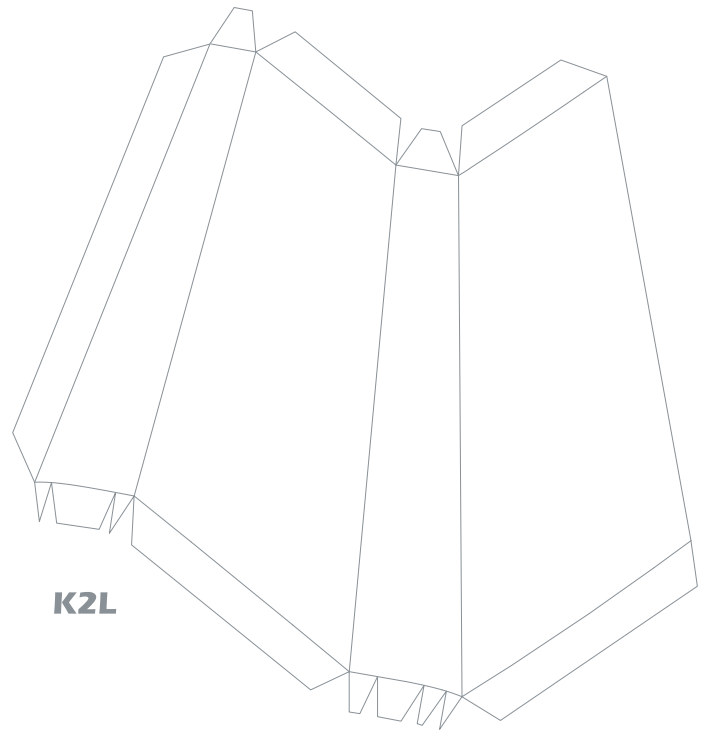

K2L

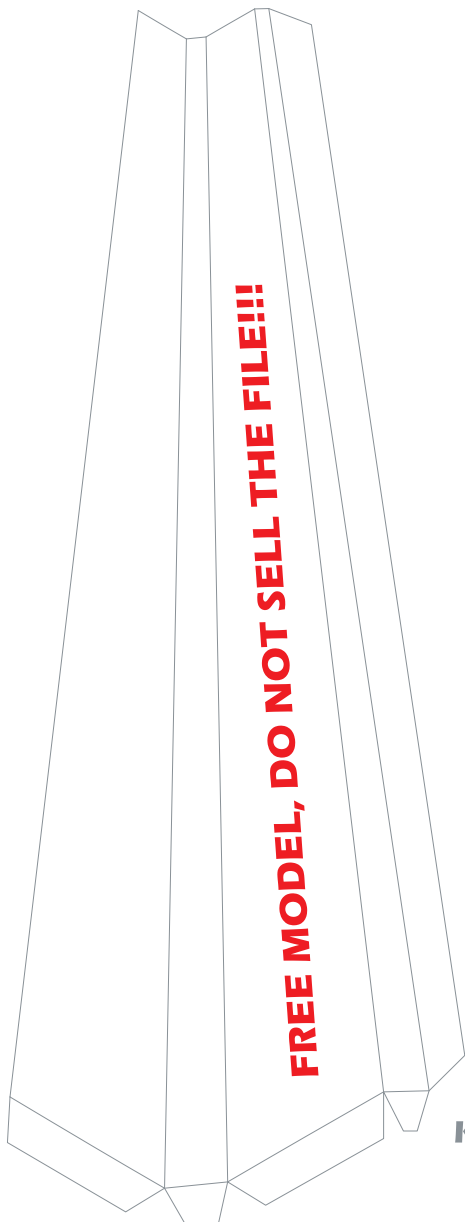

K3R

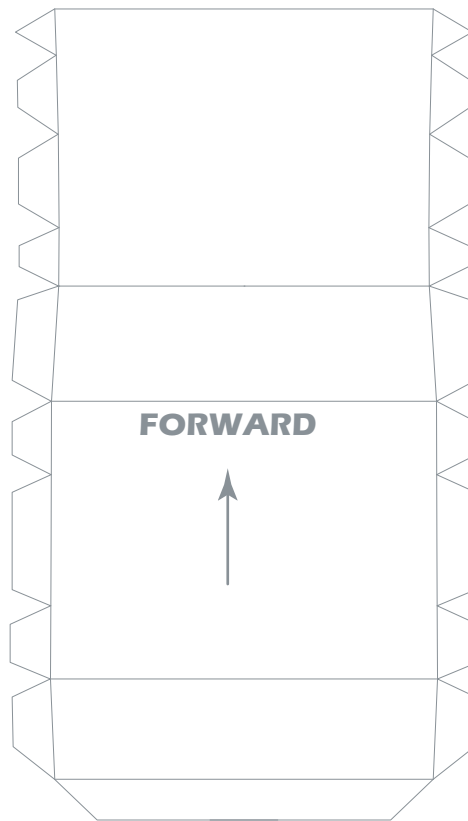

K1

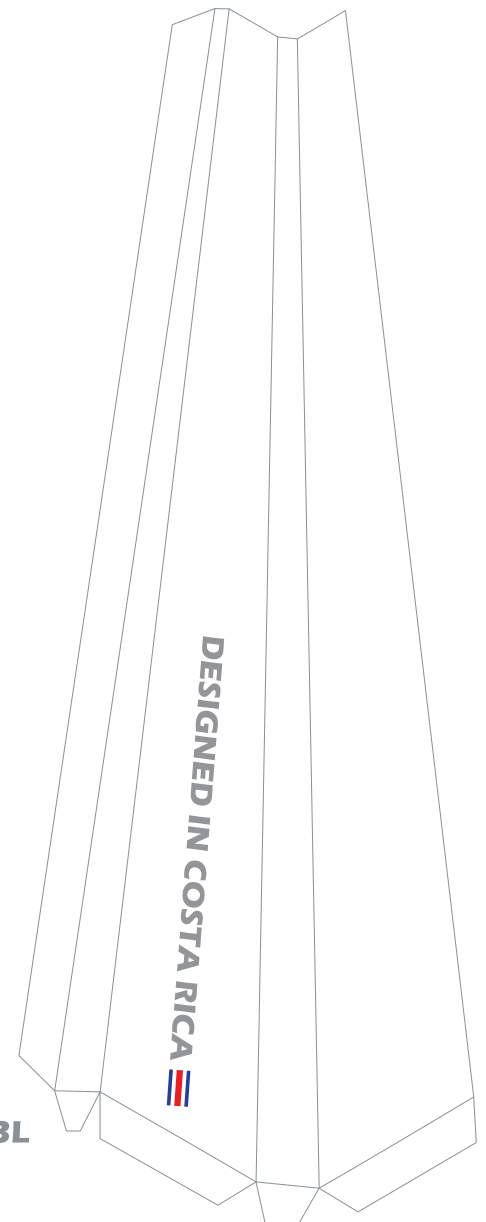

K3L

L5

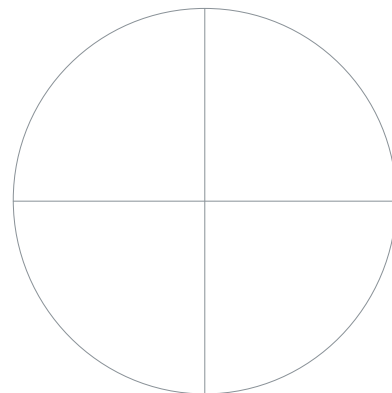
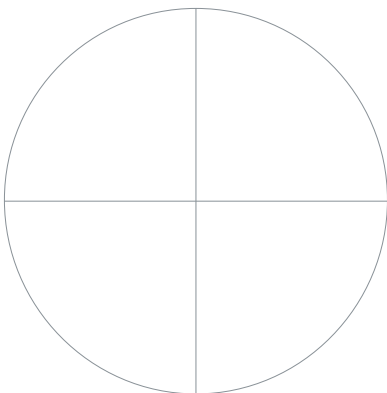
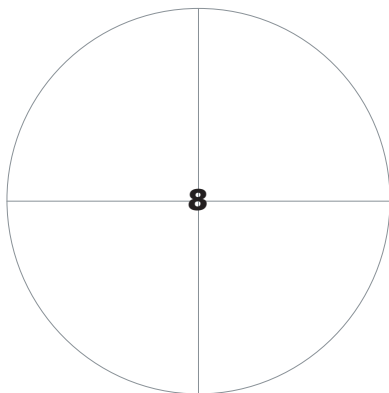

L4

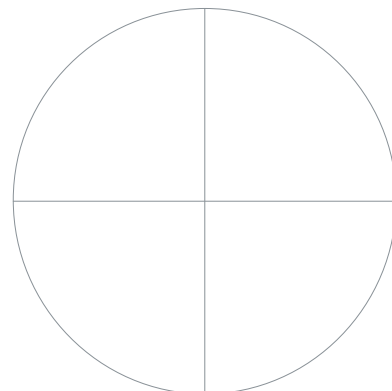
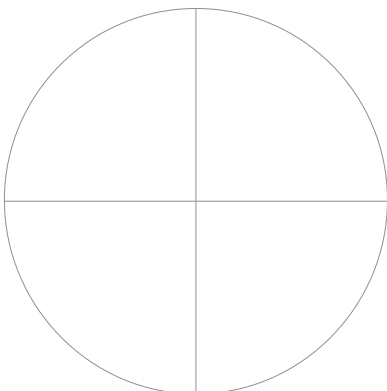
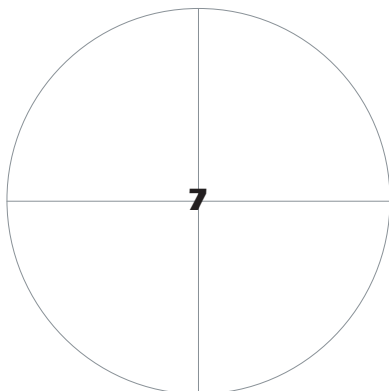

L3

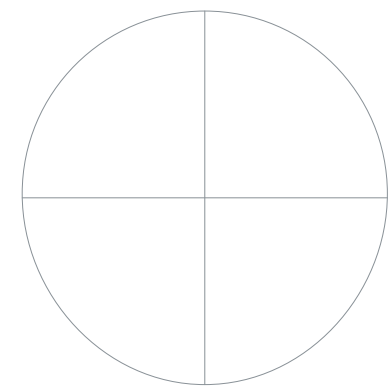
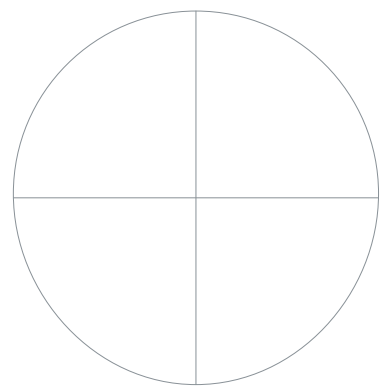
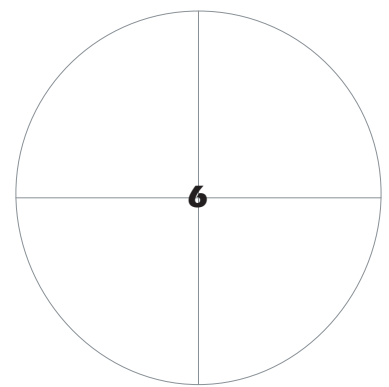

L2

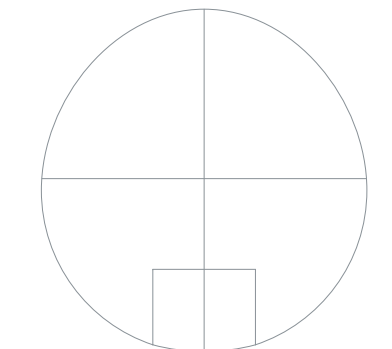
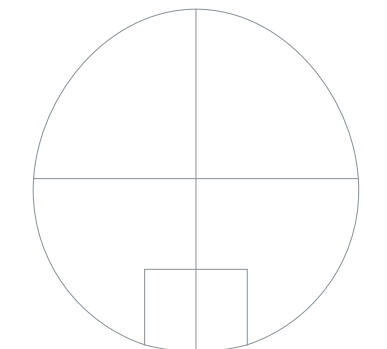
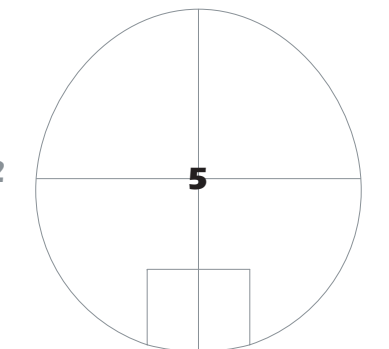

L1

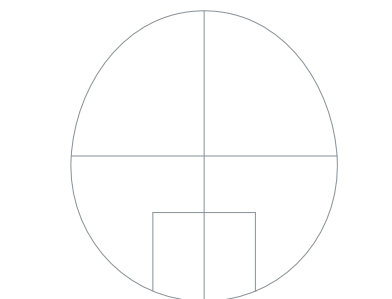
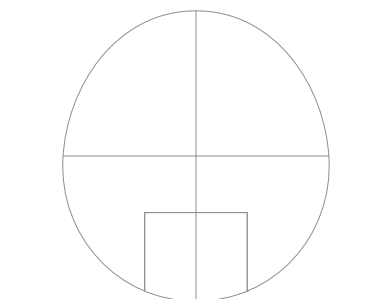
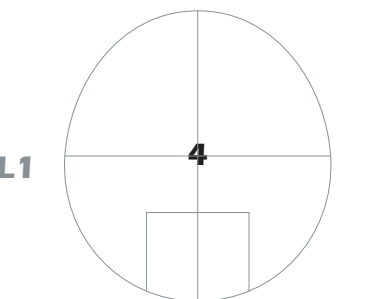

M4

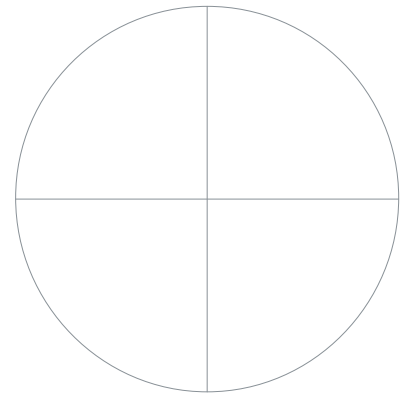
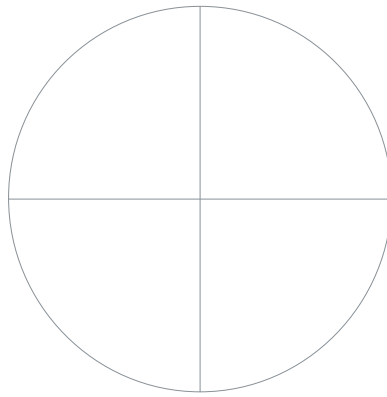
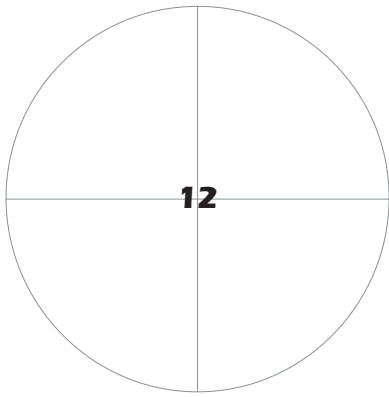

M3

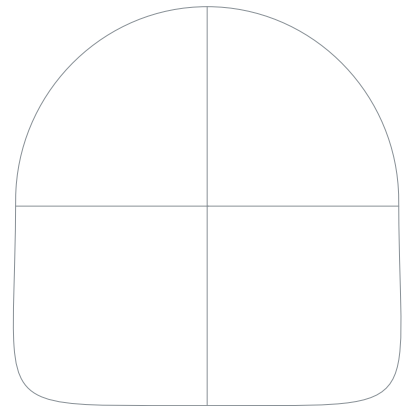
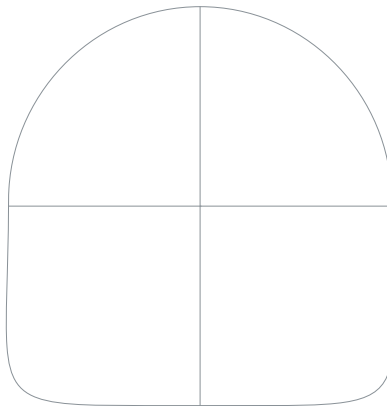
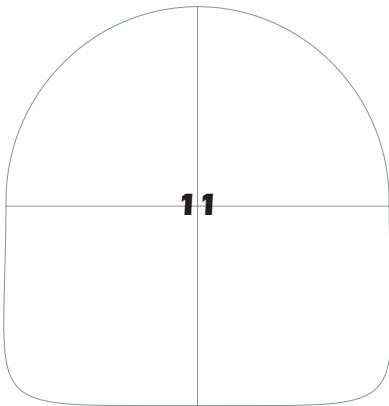

M2

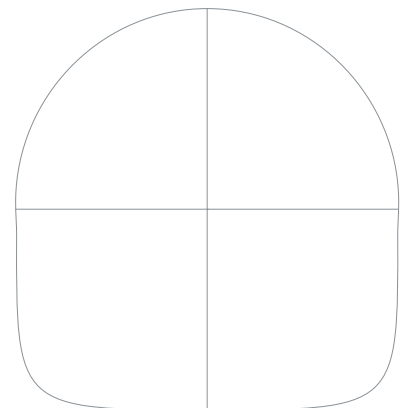
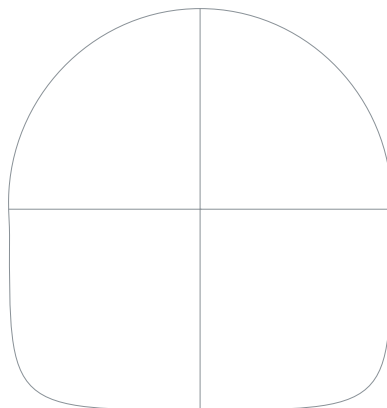
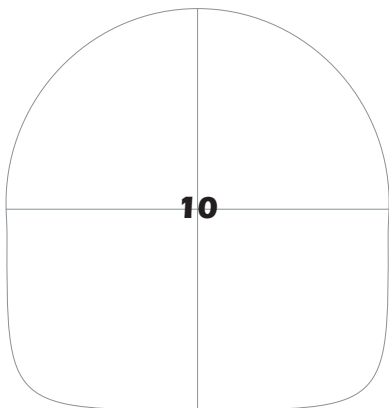

M1

