

F10



F9



F8

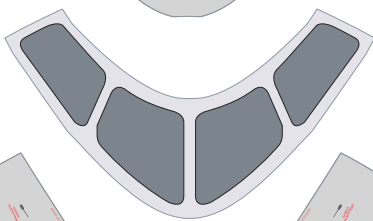

F7

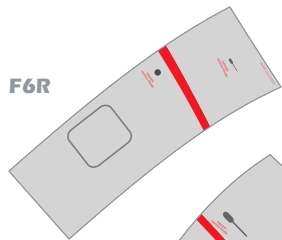

F6R

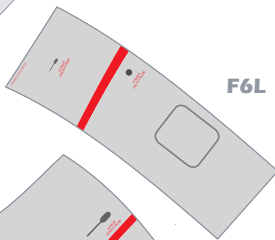

F6L

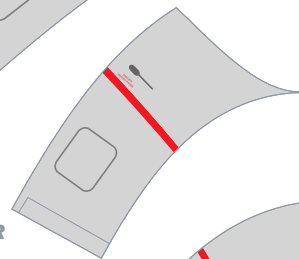

F5R

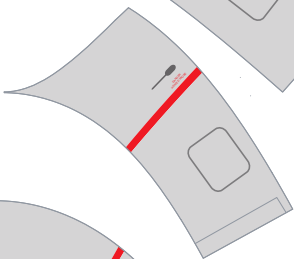

F5L

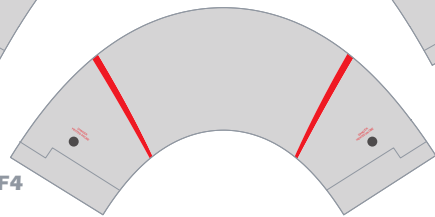

F4

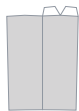

L3

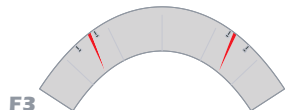

F3

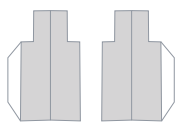

L2L

L2R



F2



F1

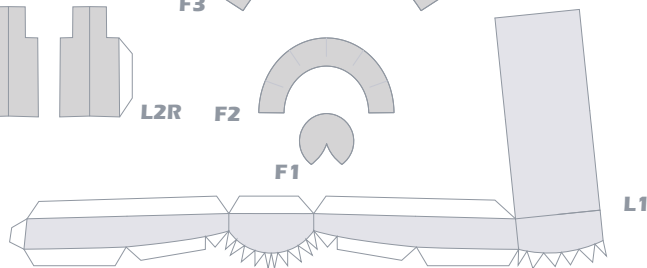

L1

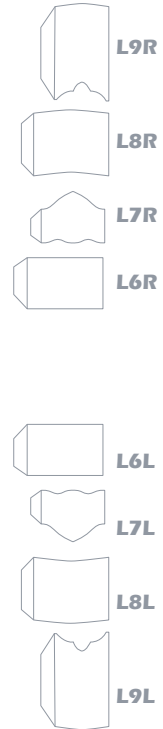

L9R

L8R

L7R

L6R

L6L

L7L

L8L

L9L

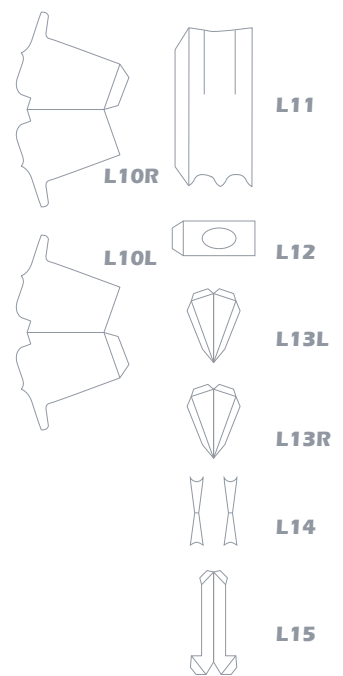

L10R

L10L

L11

L12

L13L

L13R

L14

L15

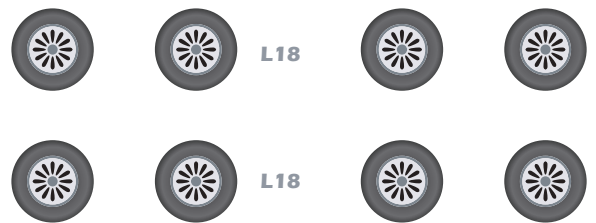

L18

L18



L19



L16



L17

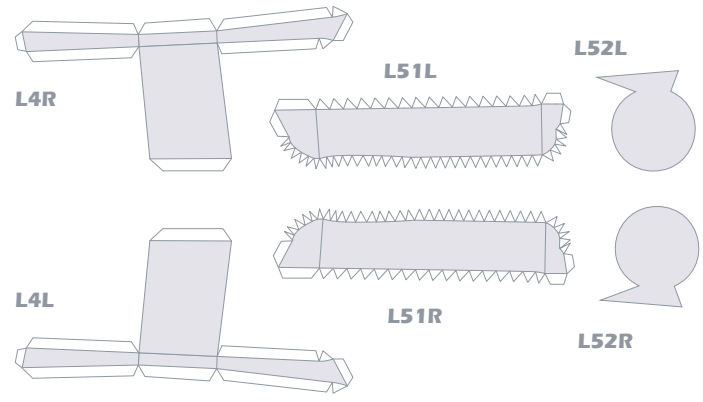

L4R

L4L

L51L

L51R

L52L

L52R

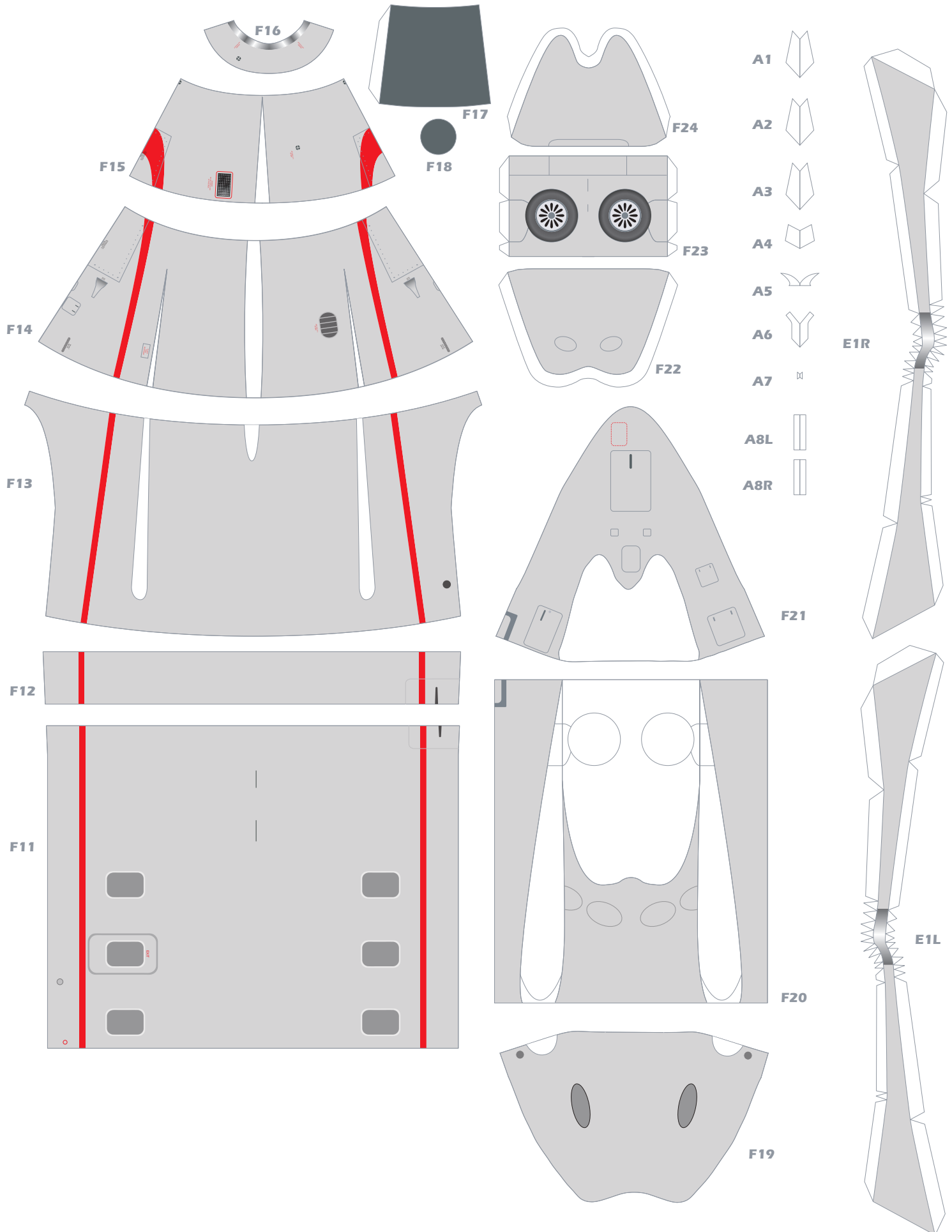

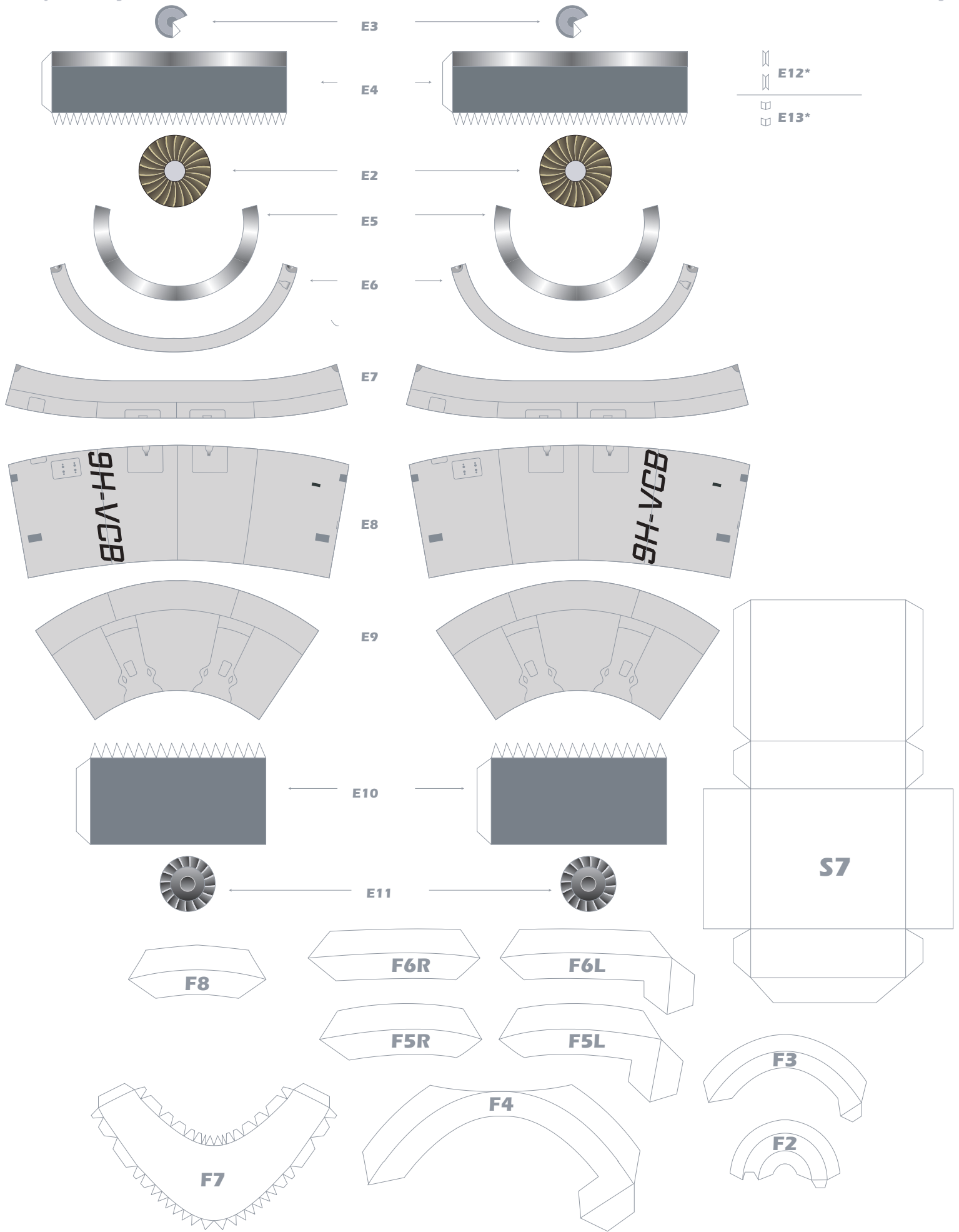

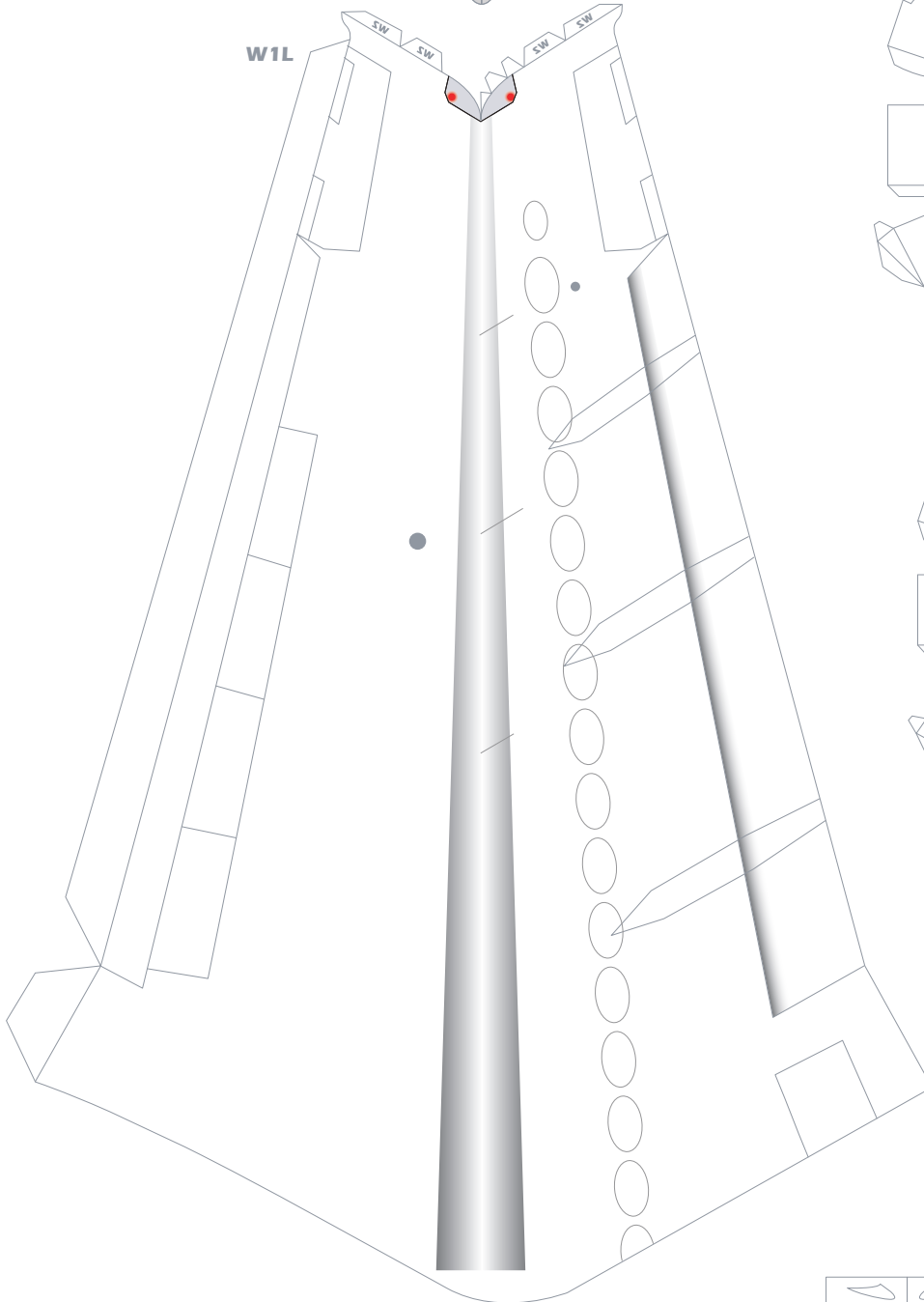
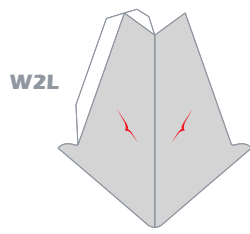

LEFT

RIGHT

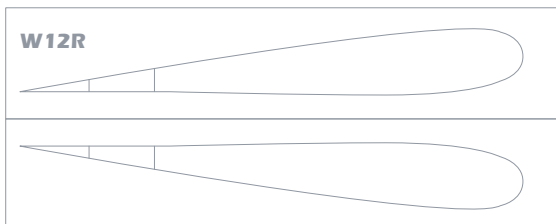
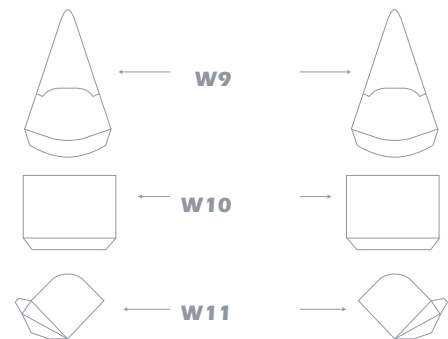
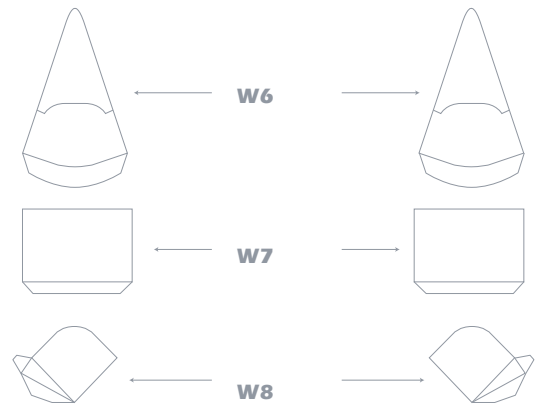
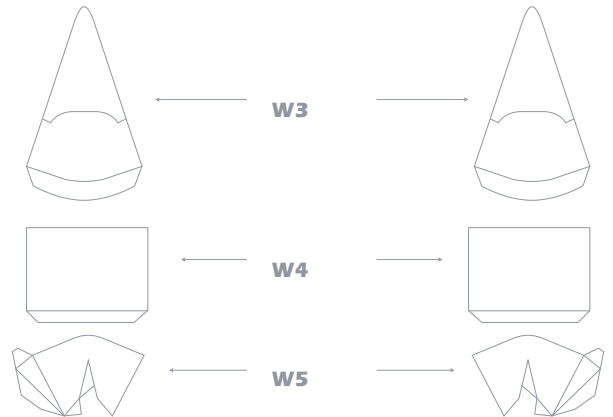

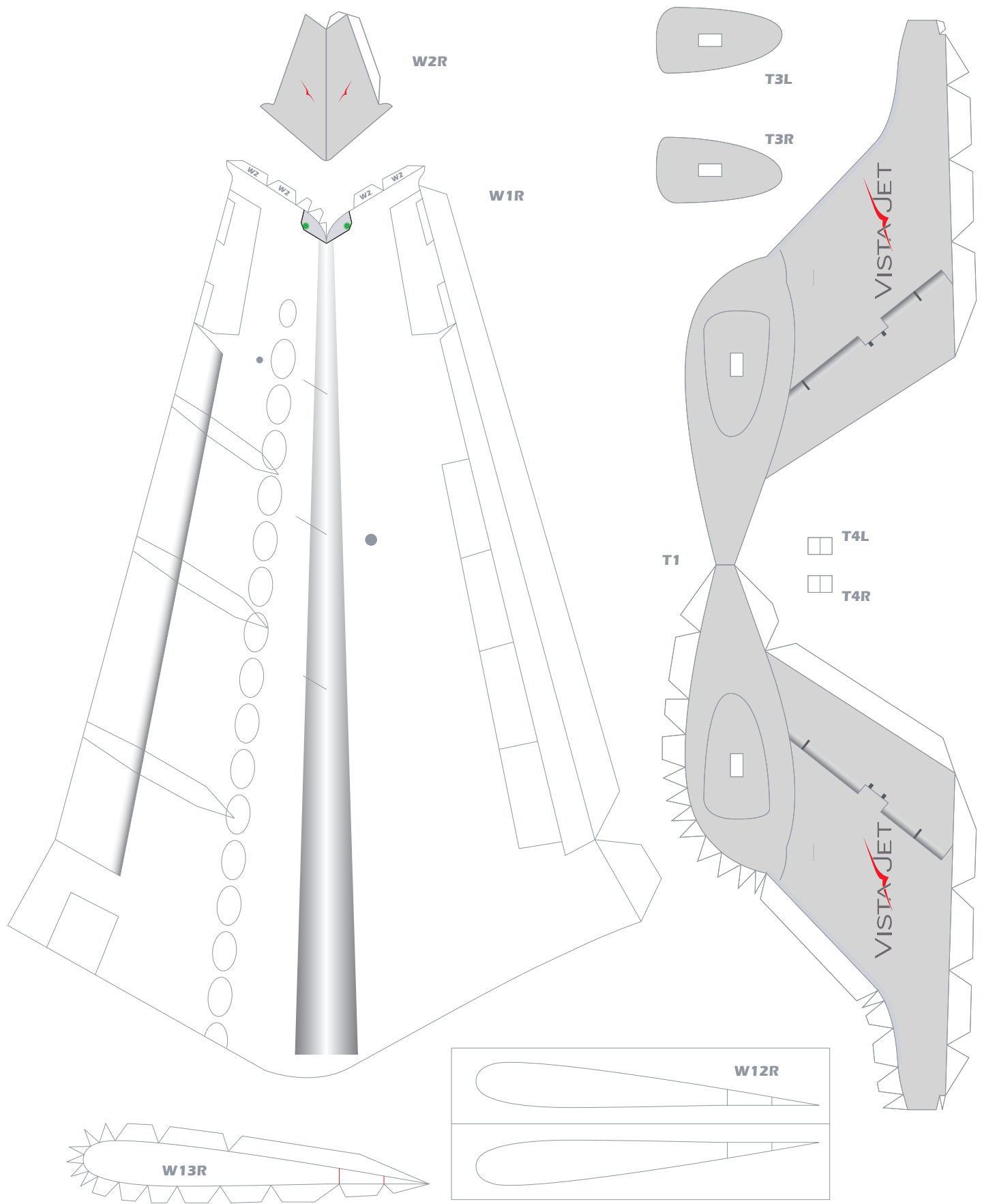

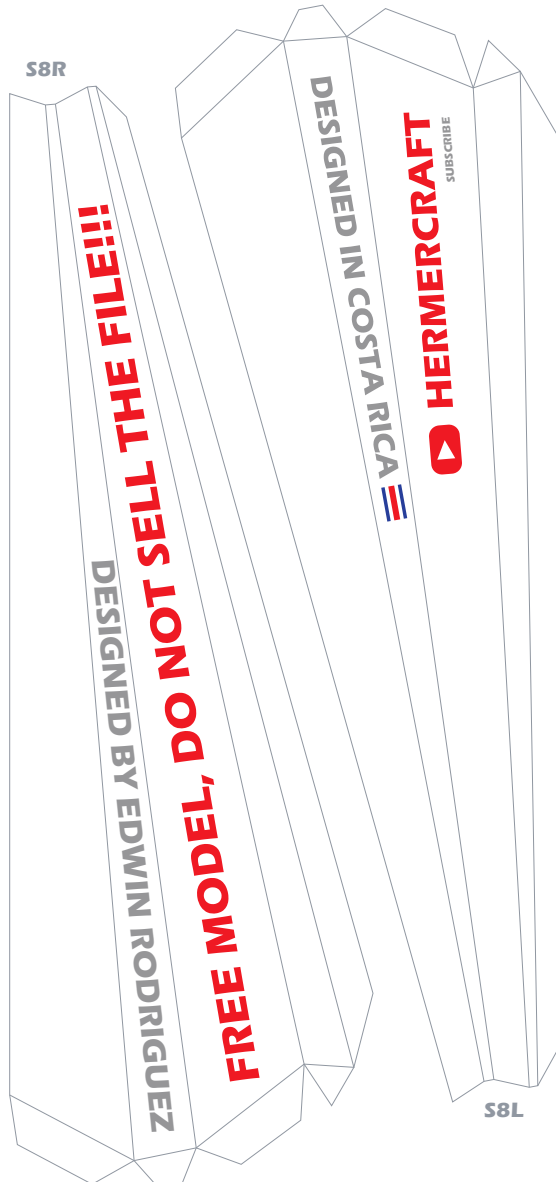
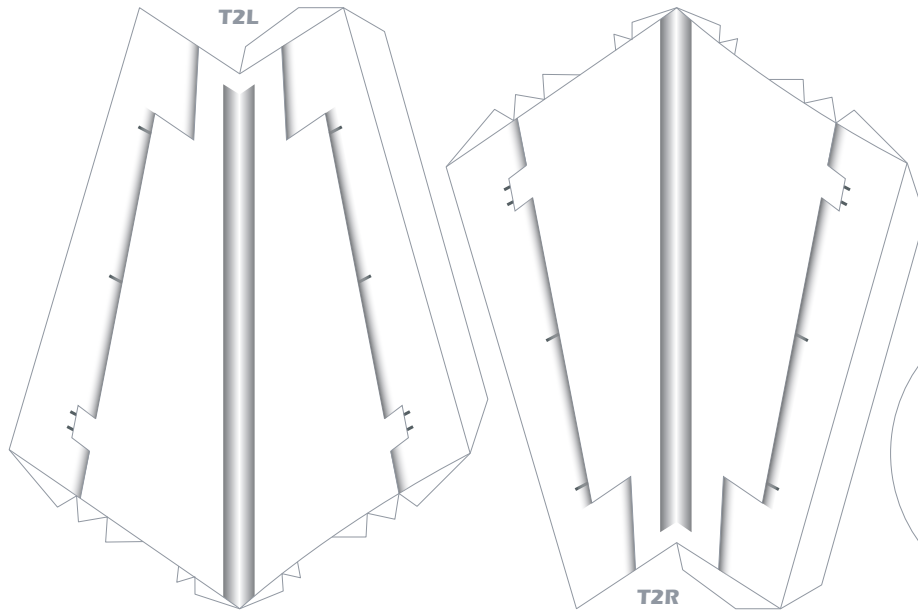

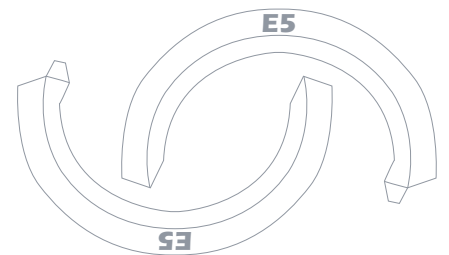
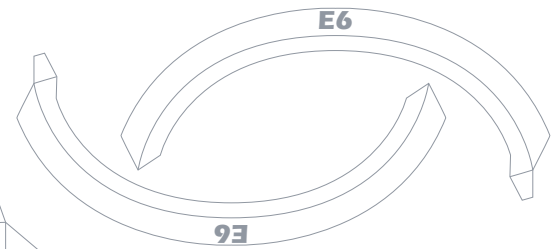
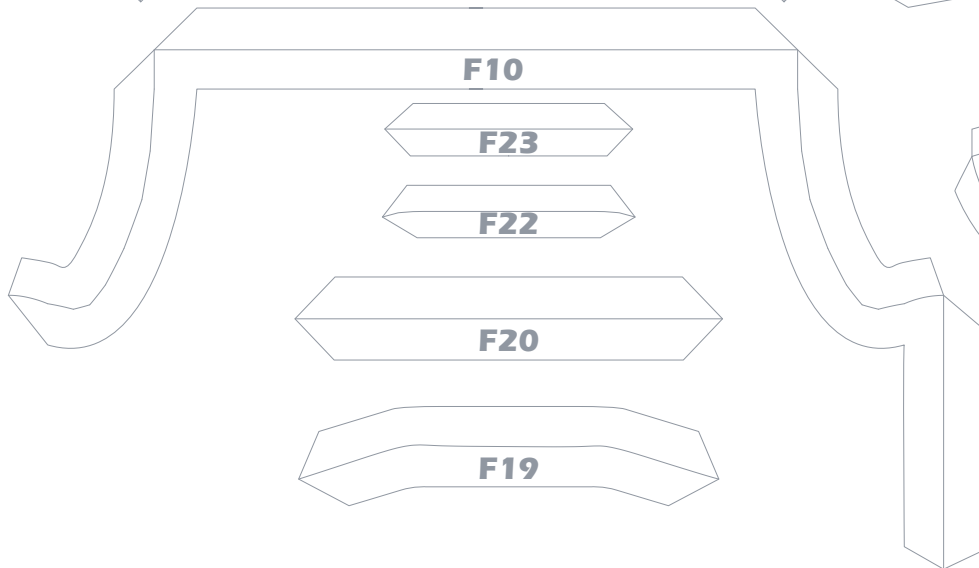
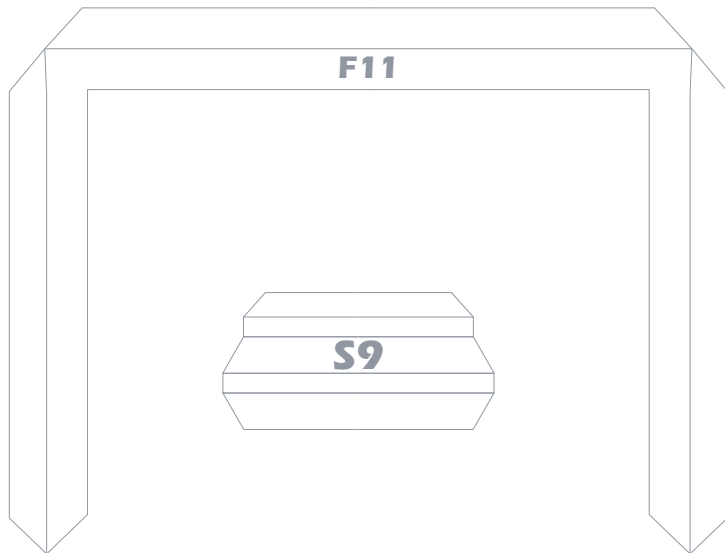
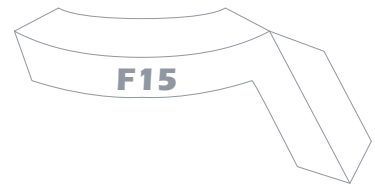
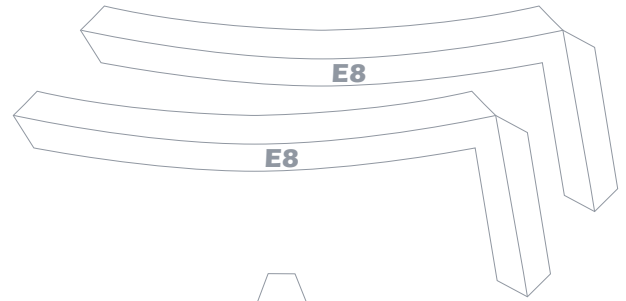

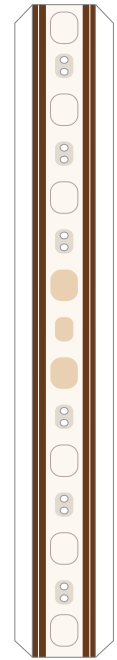
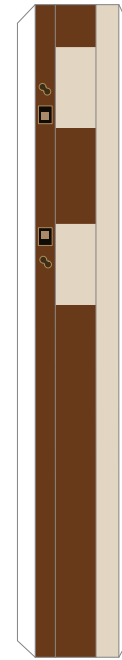
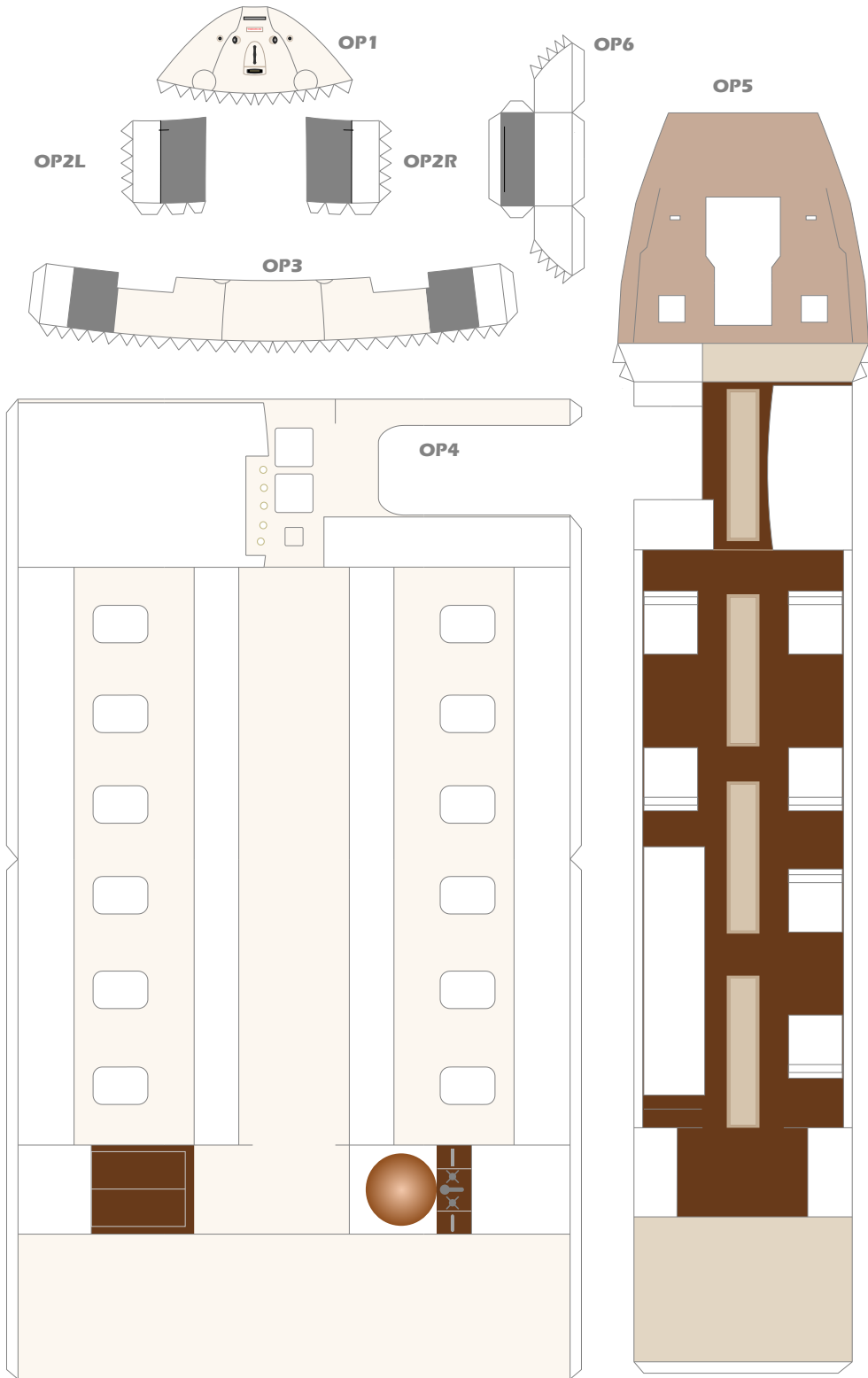

OP32L

OP33L

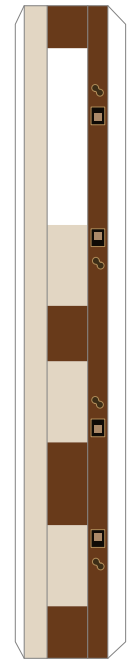
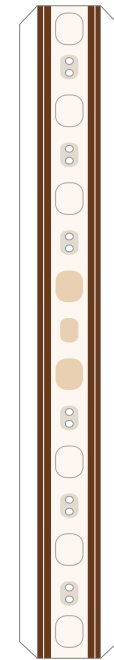

OP33R

OP32R



Tables (Optional)

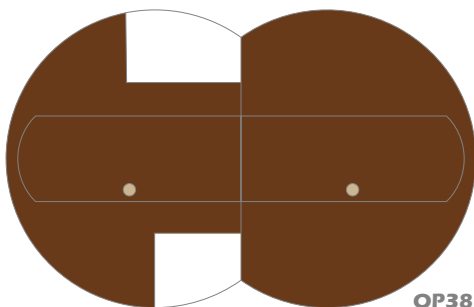

OP38

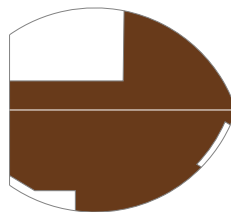

OP34

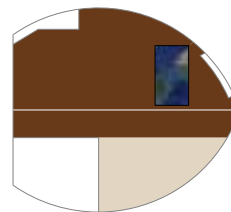

OP35

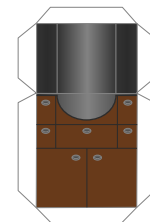

OP36

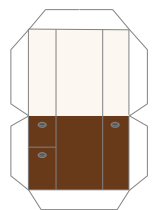

OP37



