

B4

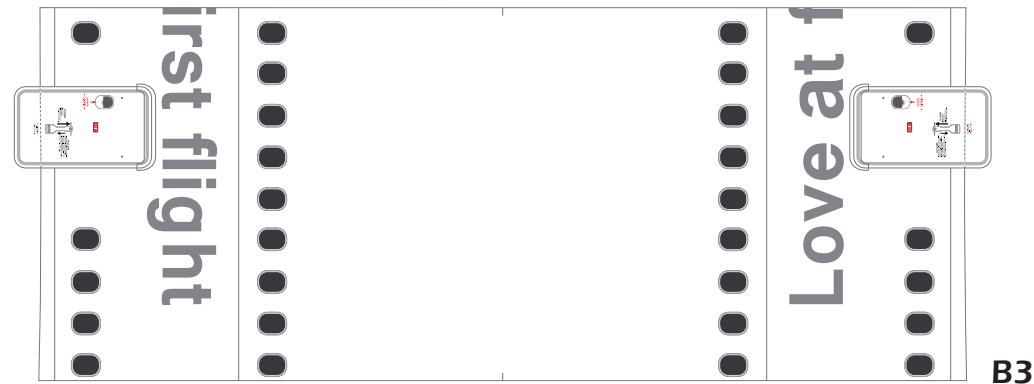

B3

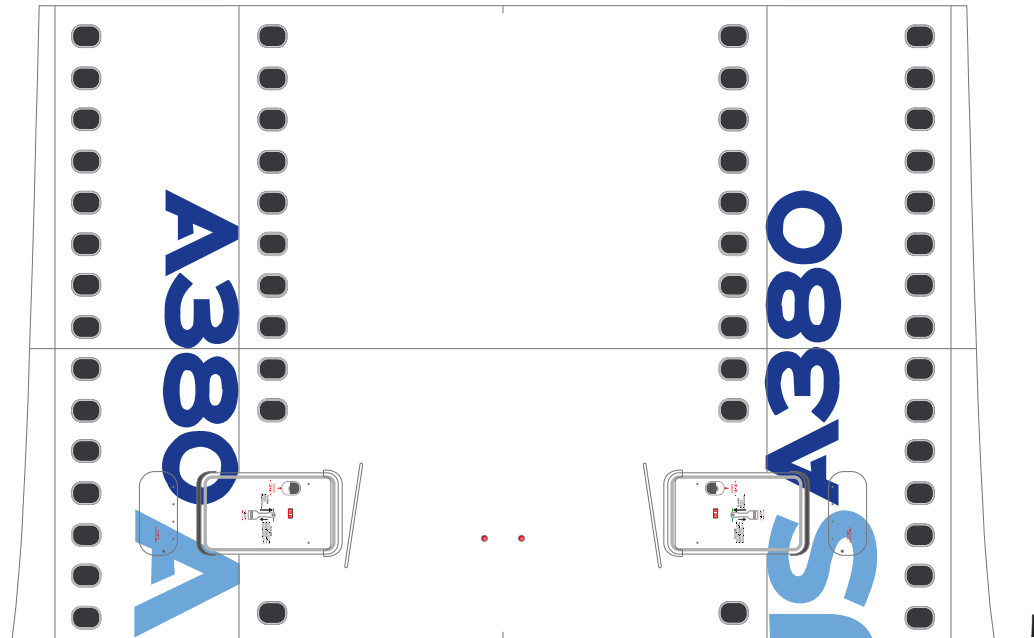

B2

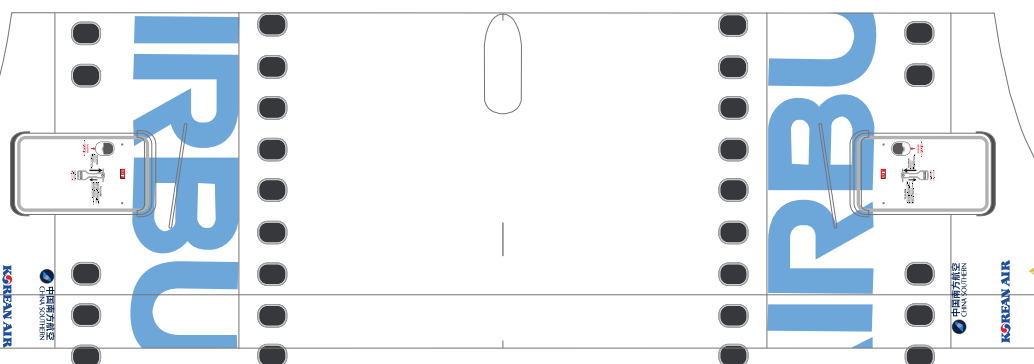

B1

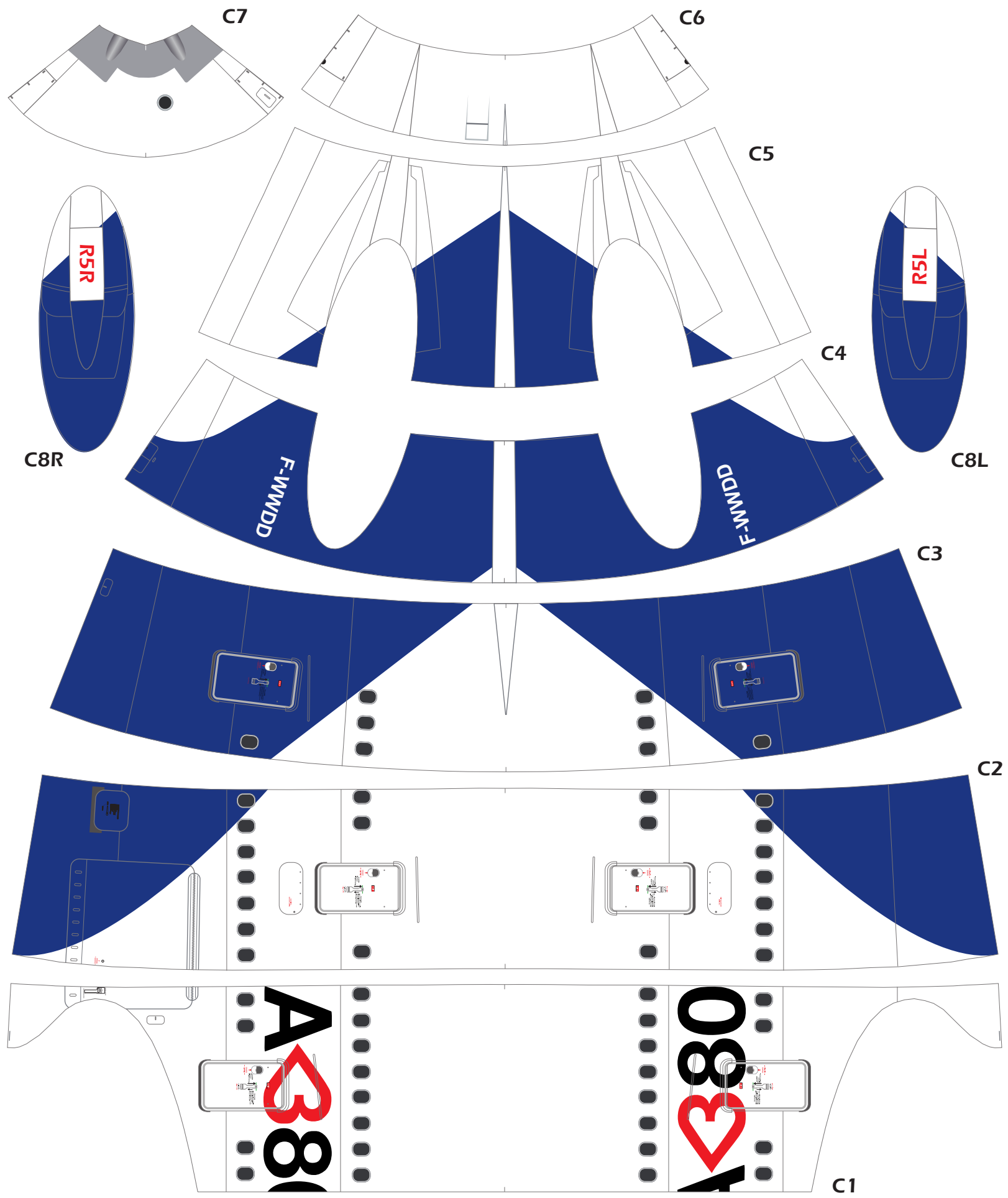

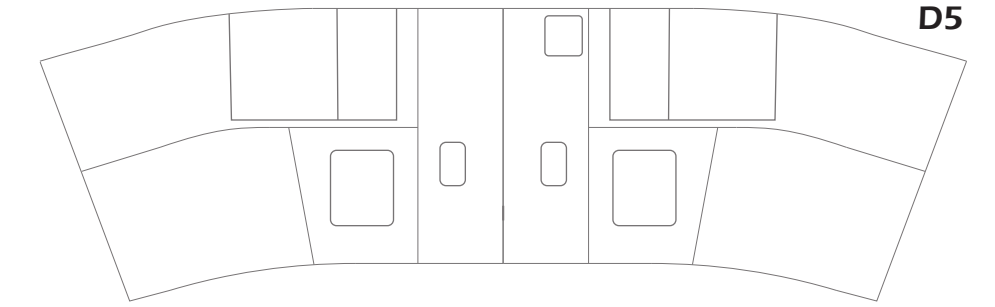
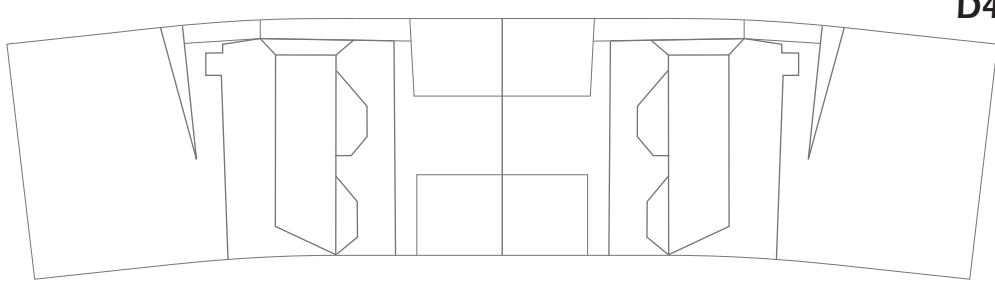
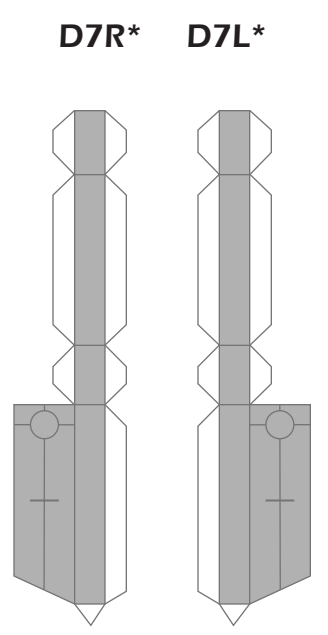
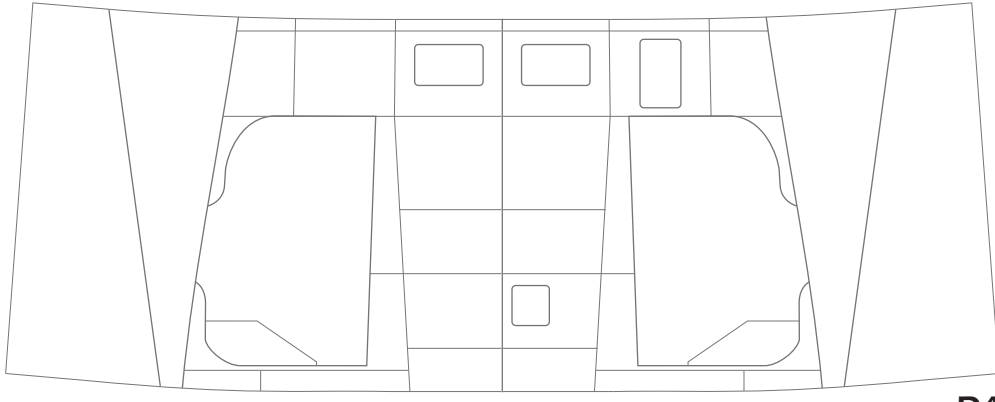
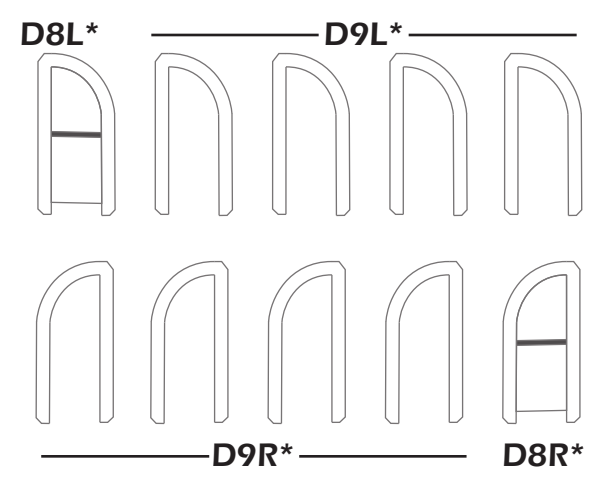
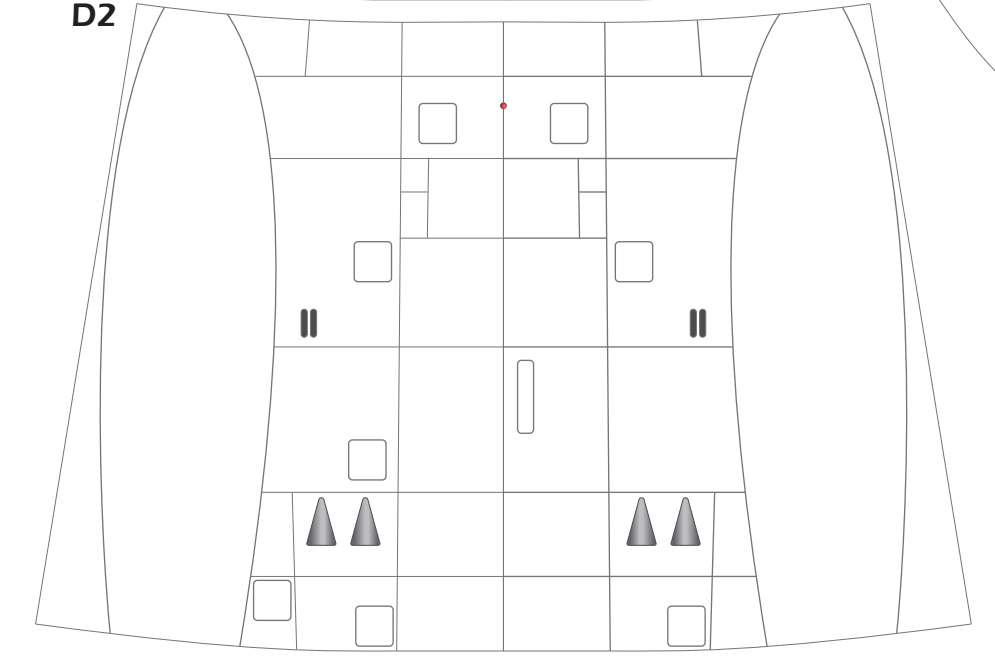
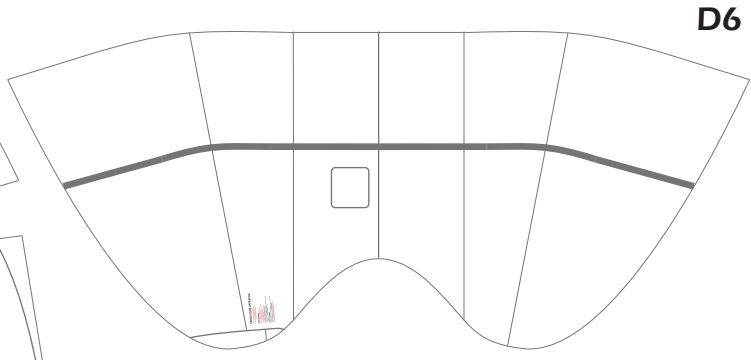
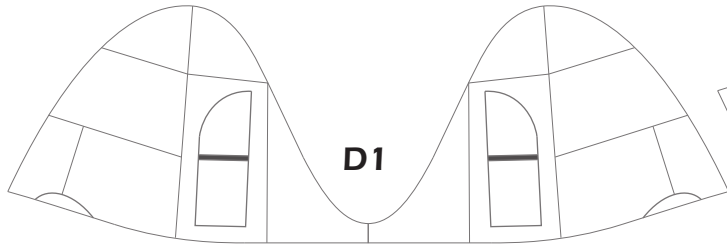

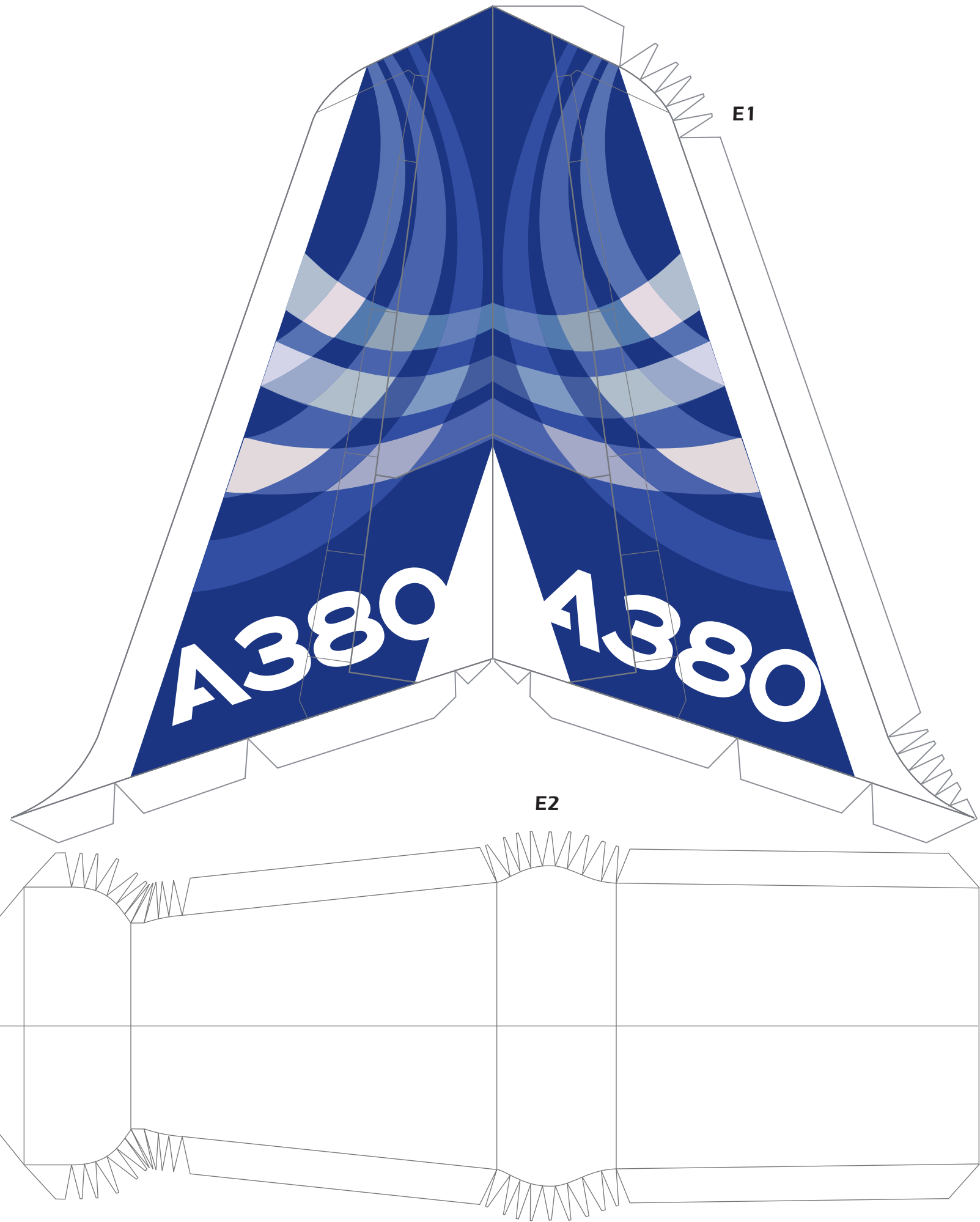

F1L

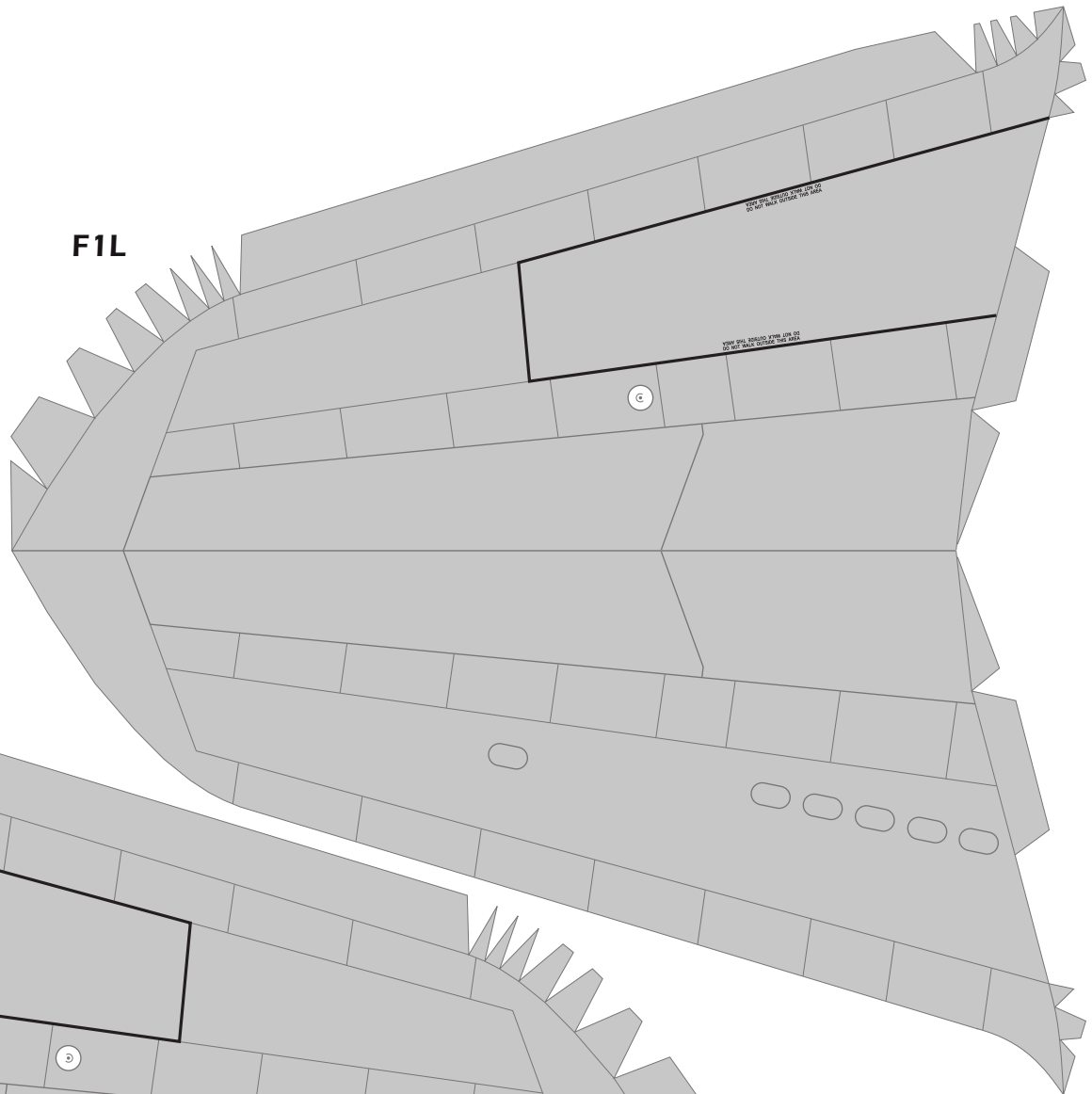

F1R

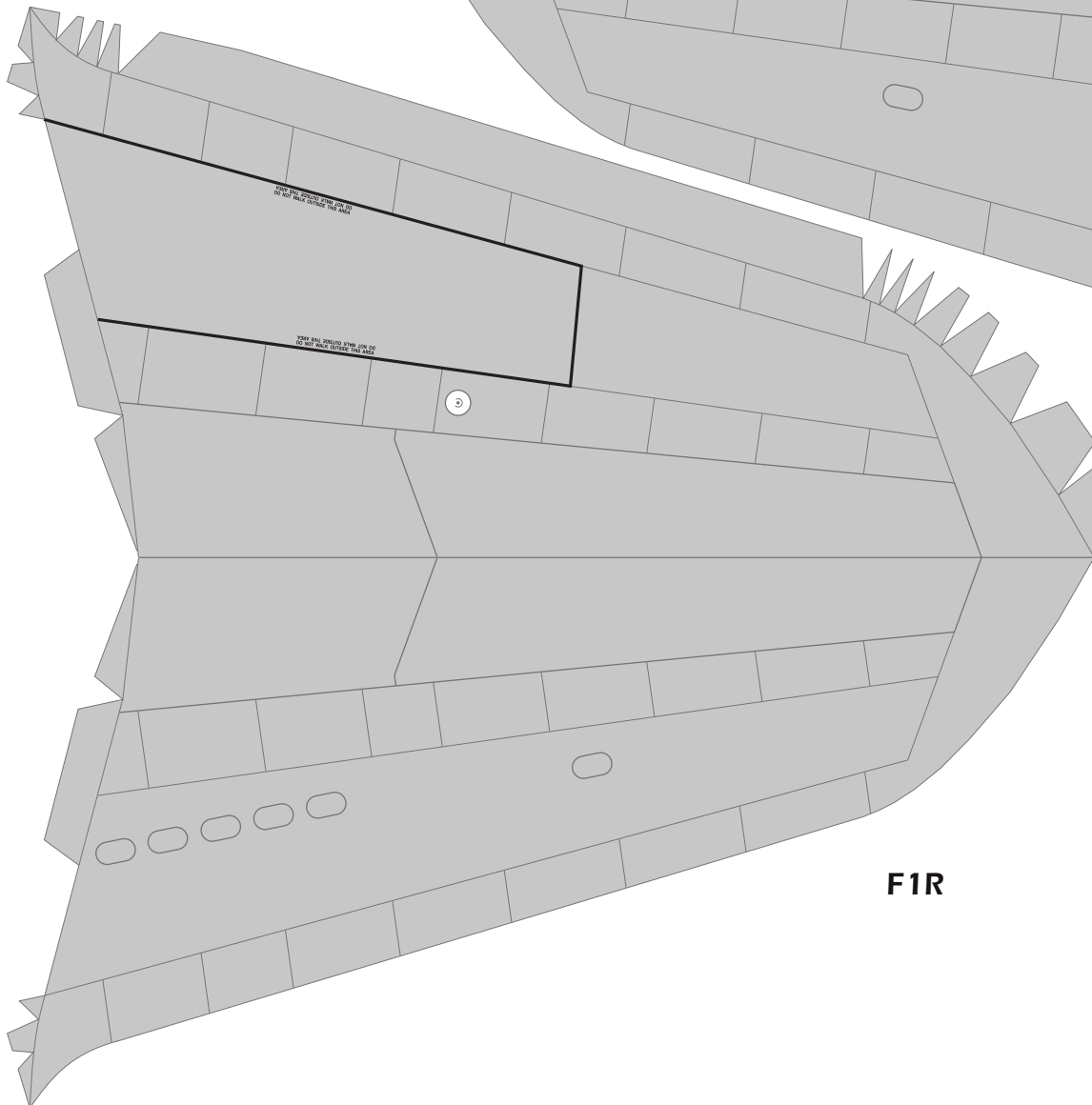

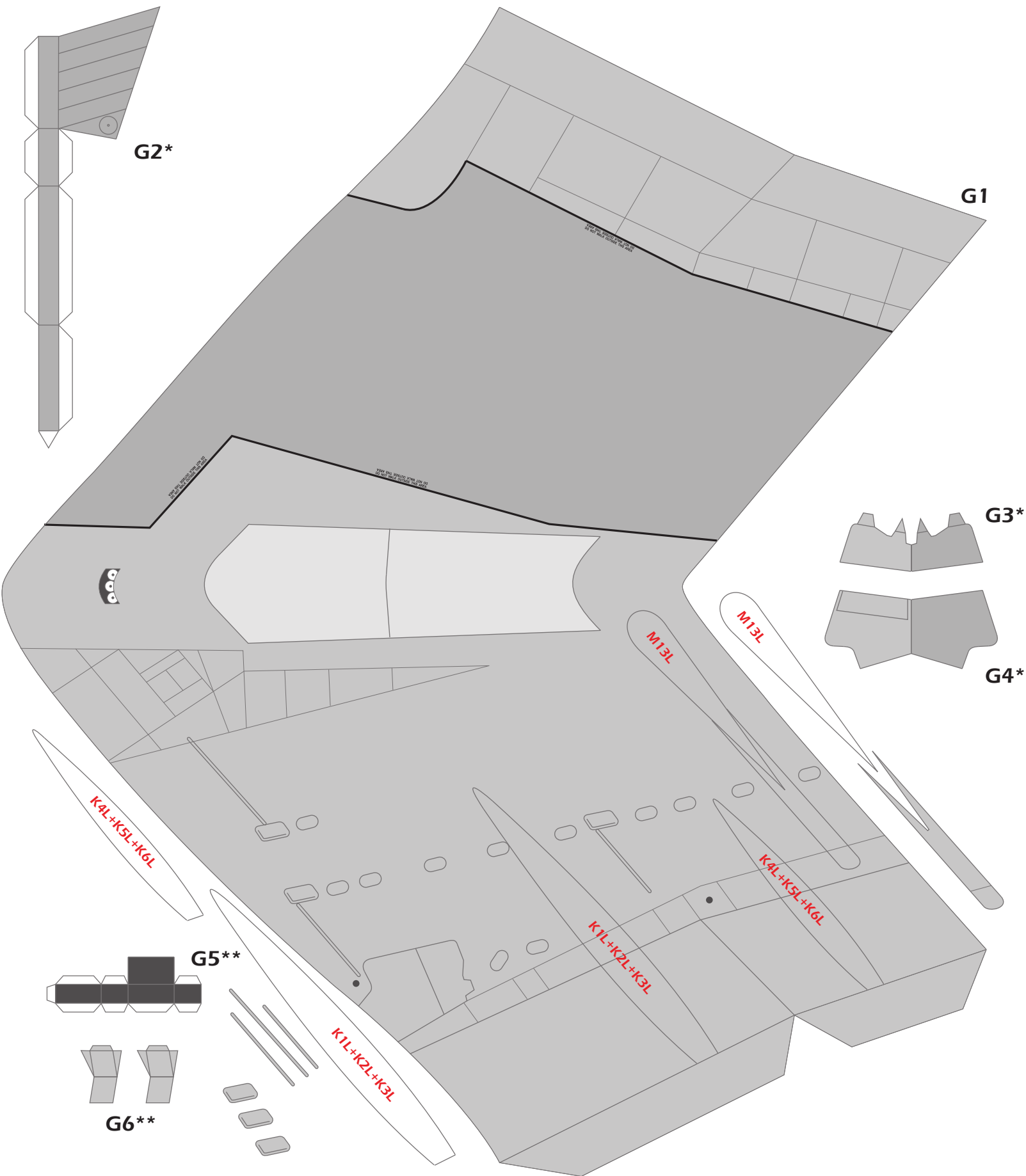

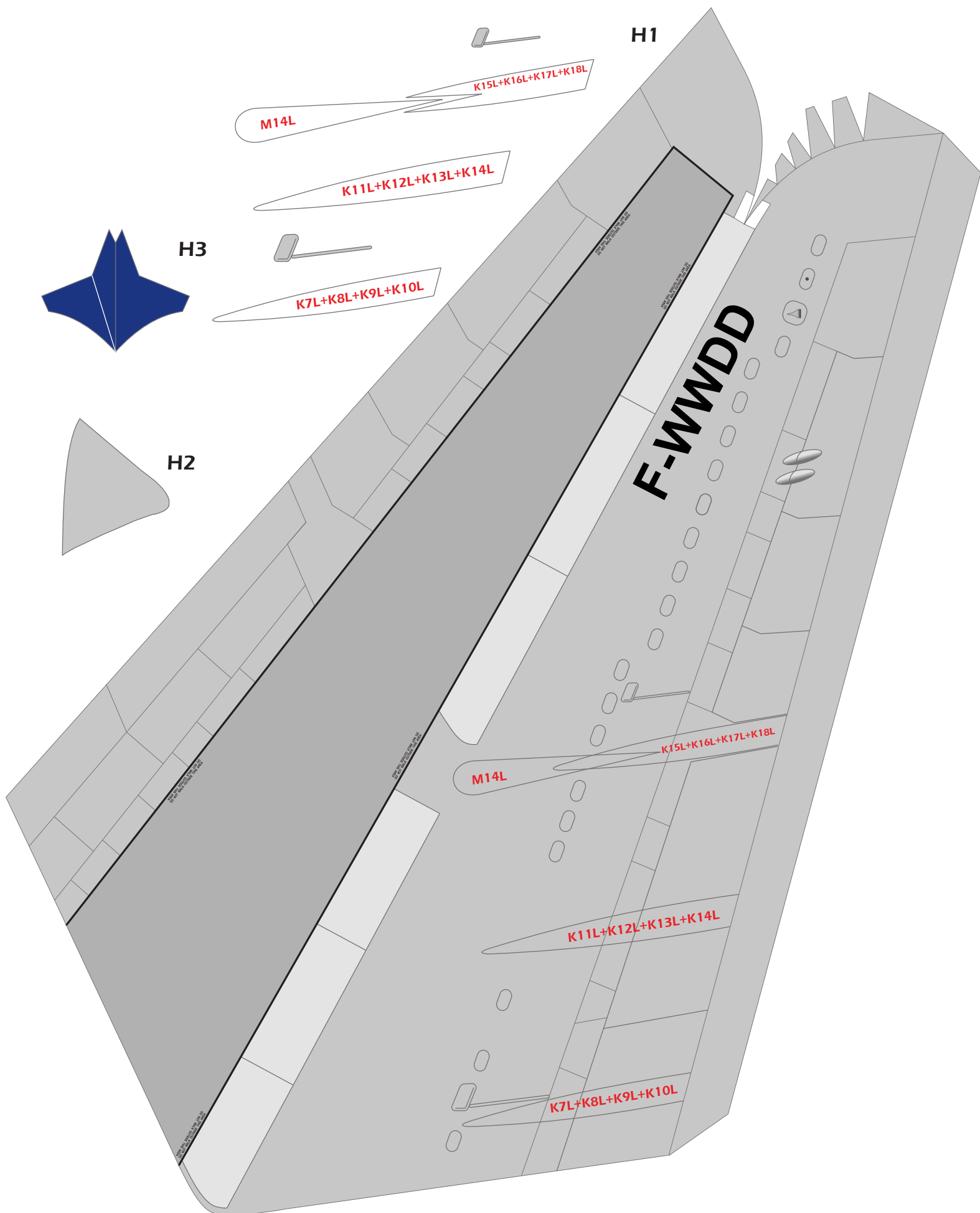



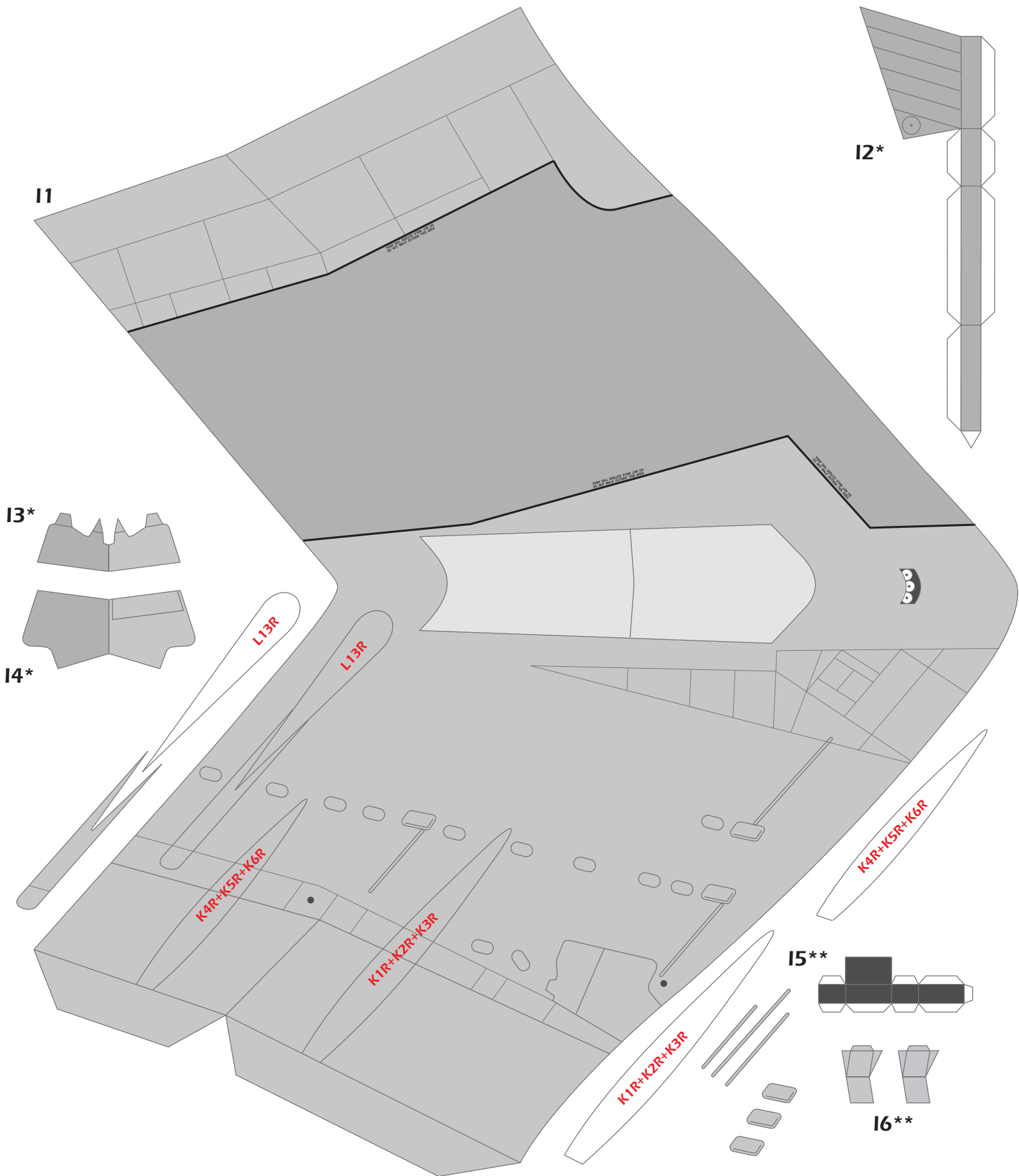

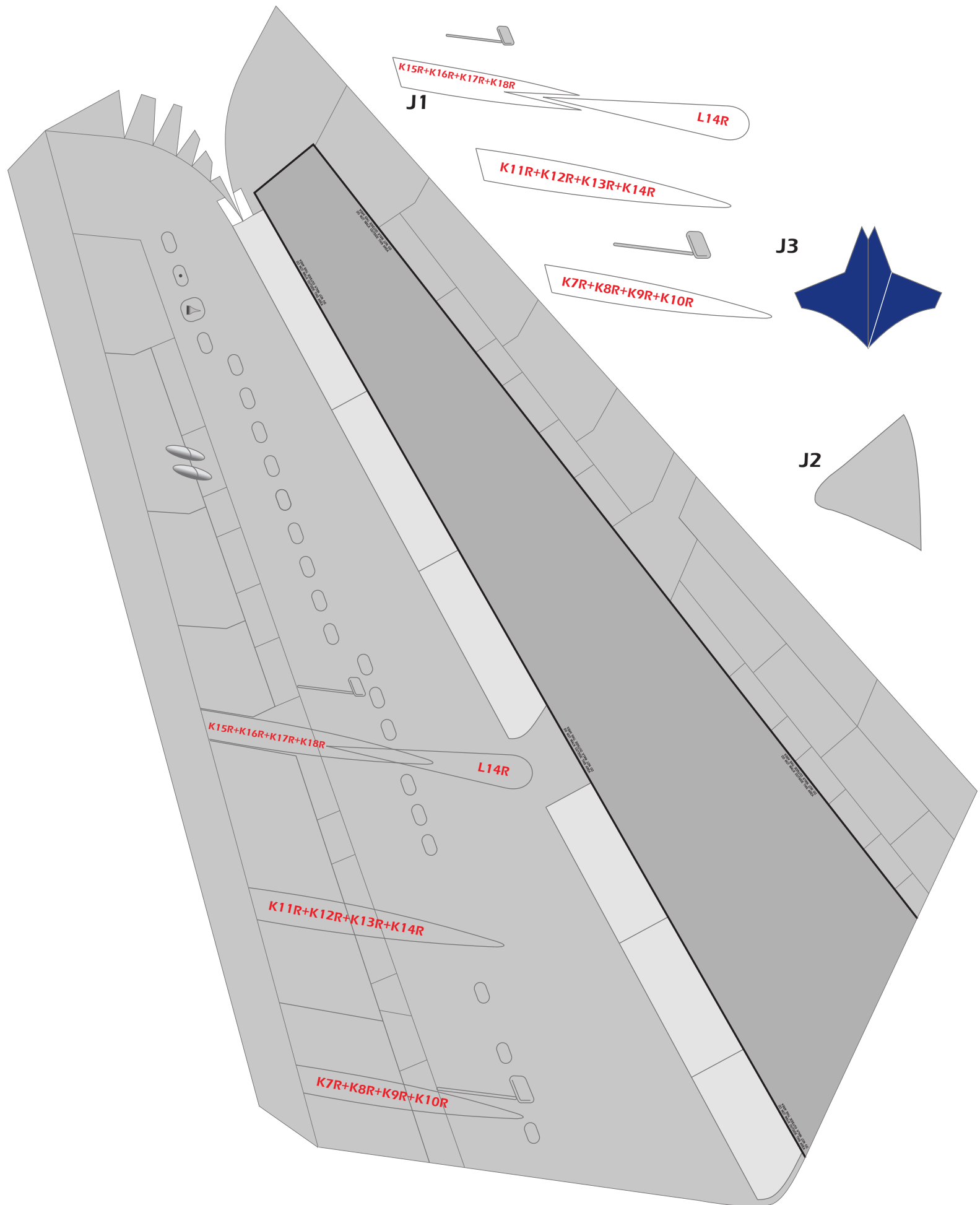

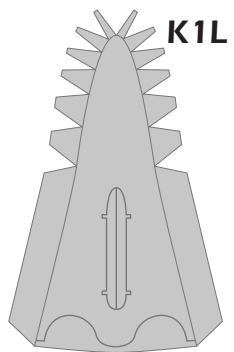

K1L

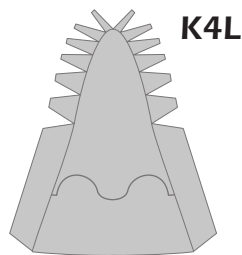

K4L

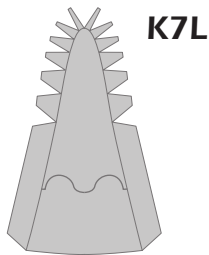

K7L

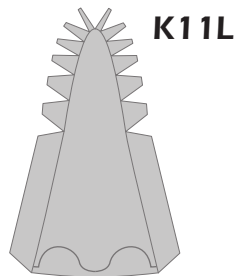

K11L

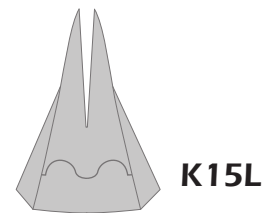

K15L



K5L

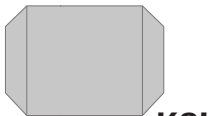

K8L



K12L

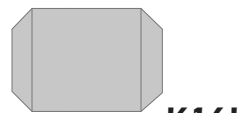

K16L

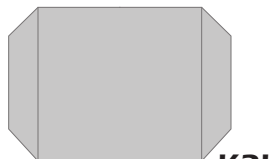

K2L

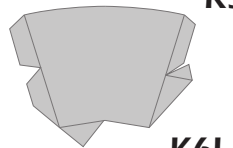

K6L

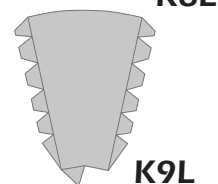

K9L

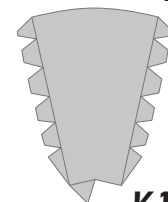

K13L



K17L

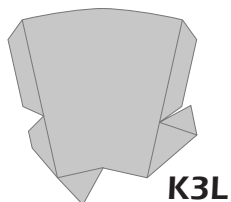

K3L



K10L



K14L

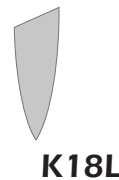

K18L

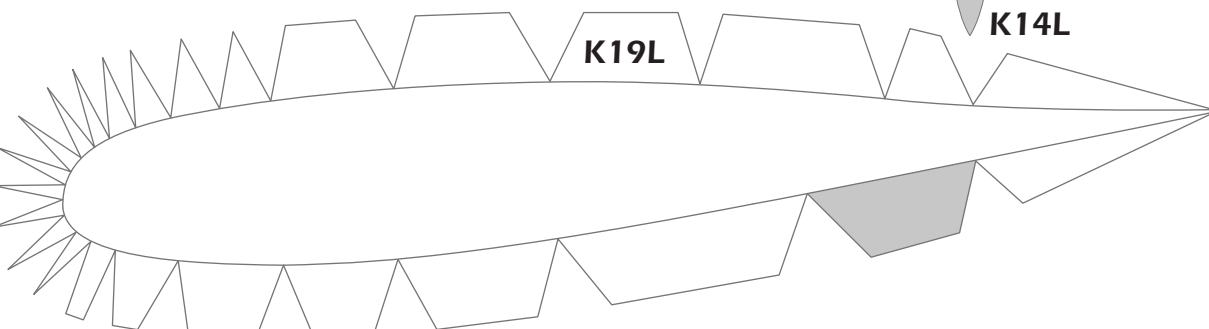

K19L

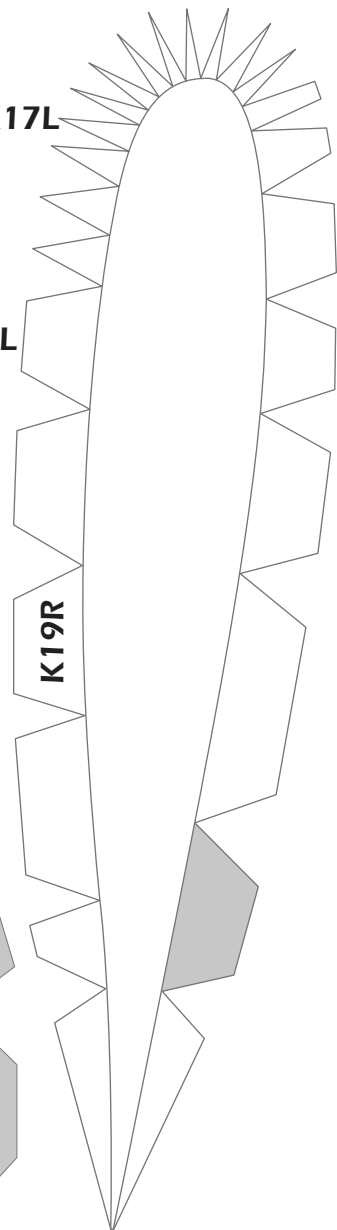

K19R

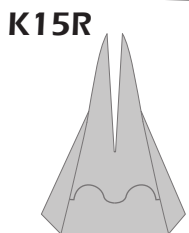

K15R

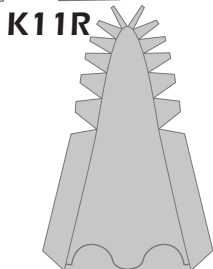

K11R

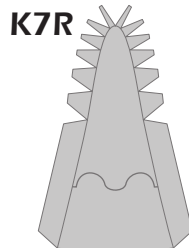

K7R

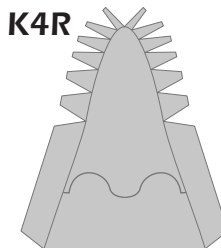

K4R

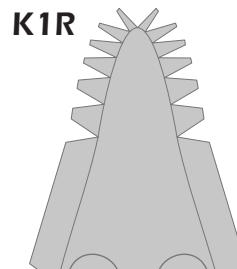

K1R



K16R



K8R



K5R



K12R

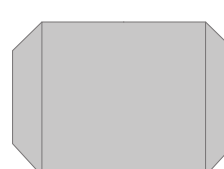

K2R

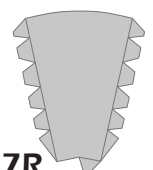

K17R

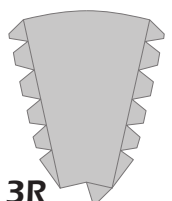

K9R

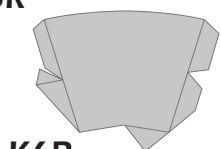

K6R

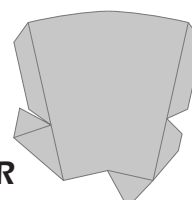

K3R



K18R

K13R



K14R



K10R

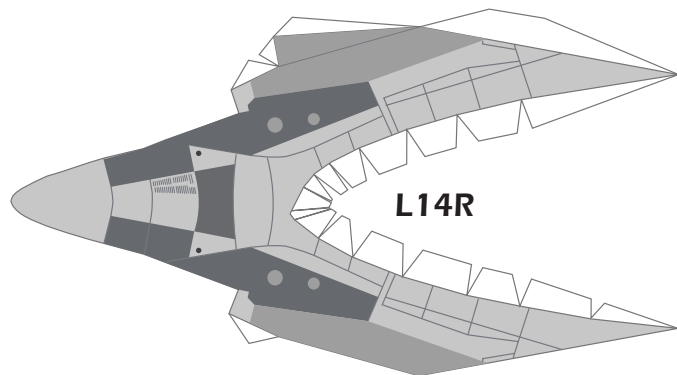
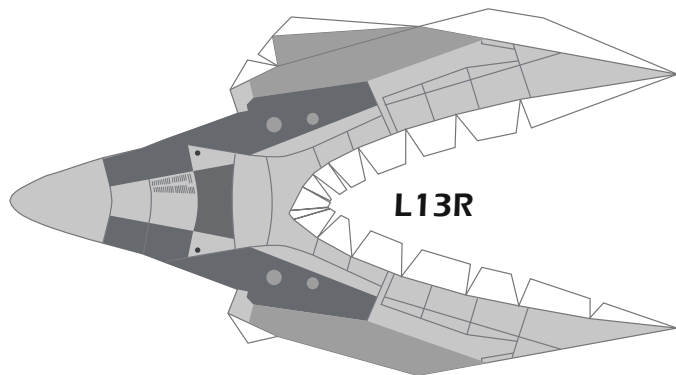
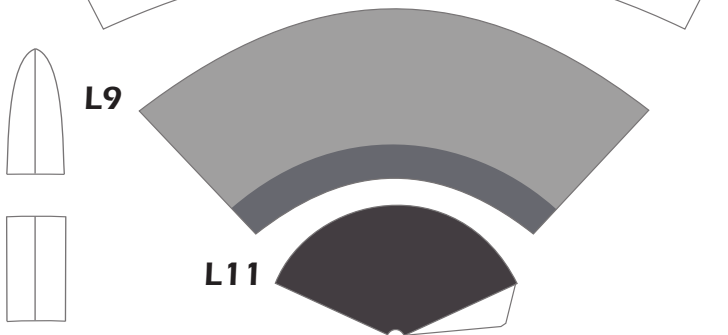
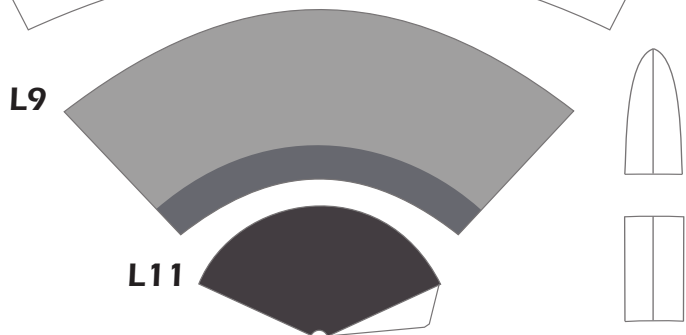
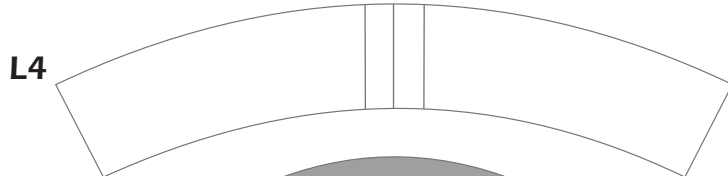
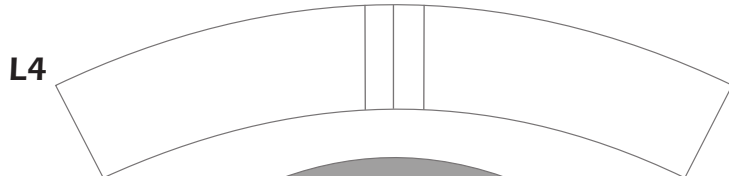
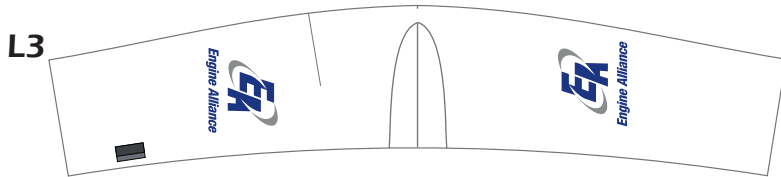
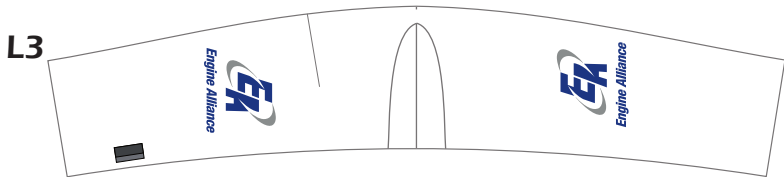
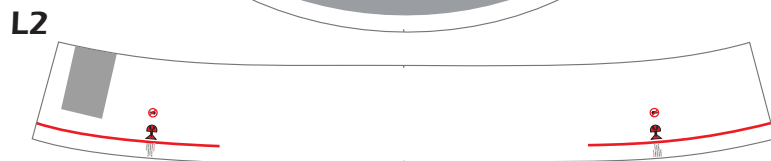
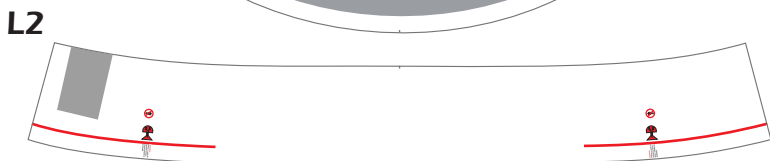
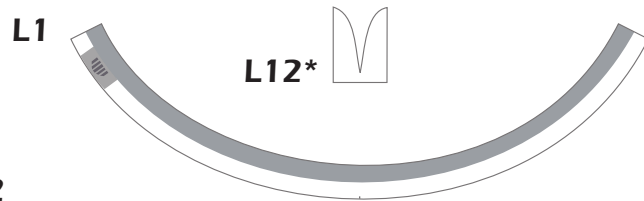
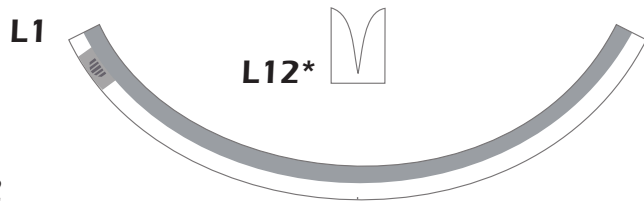
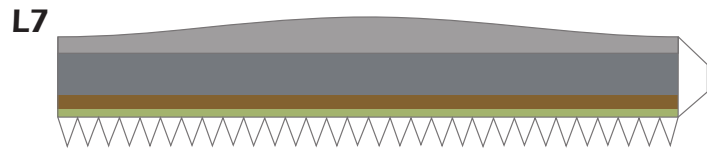
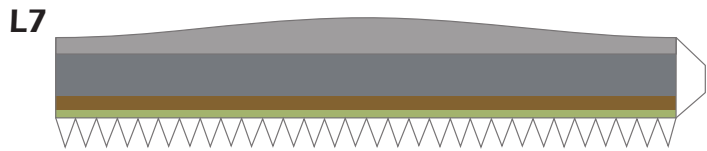
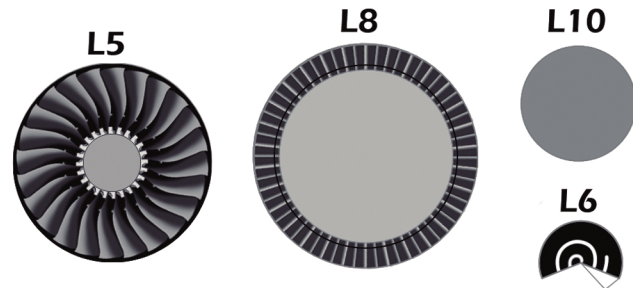
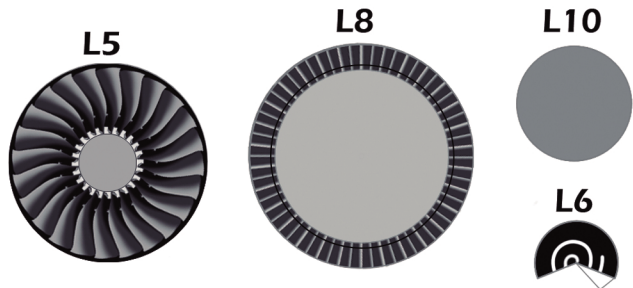

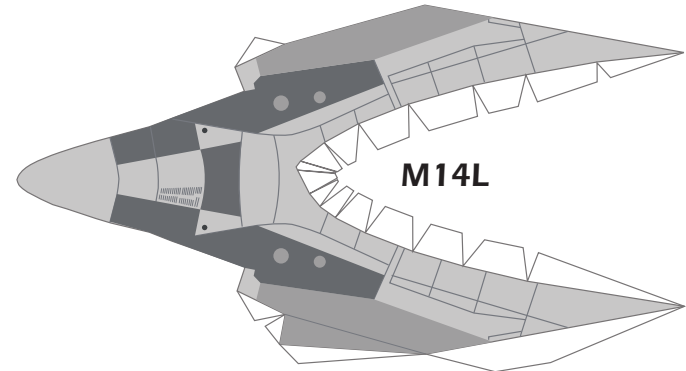
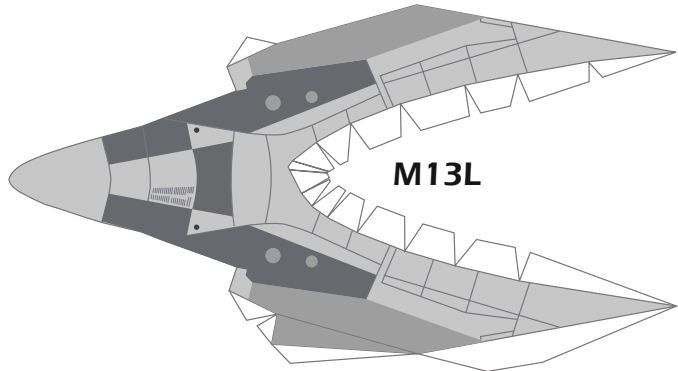
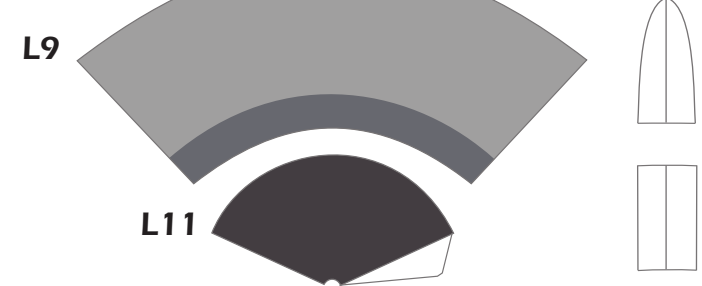
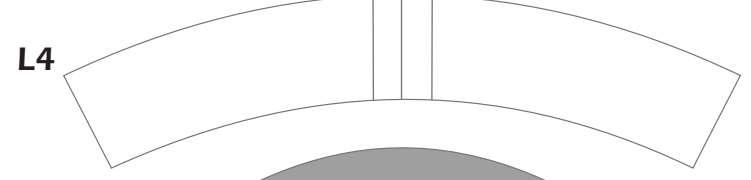
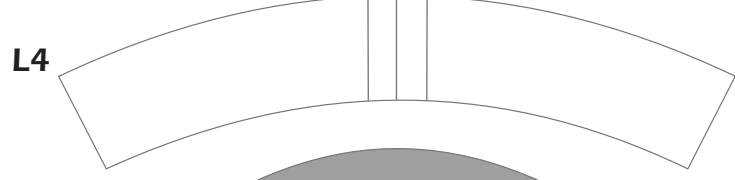
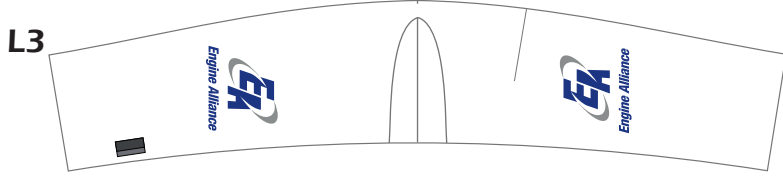
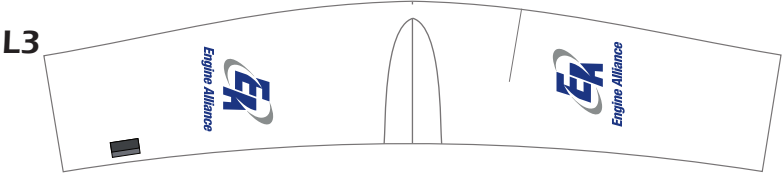
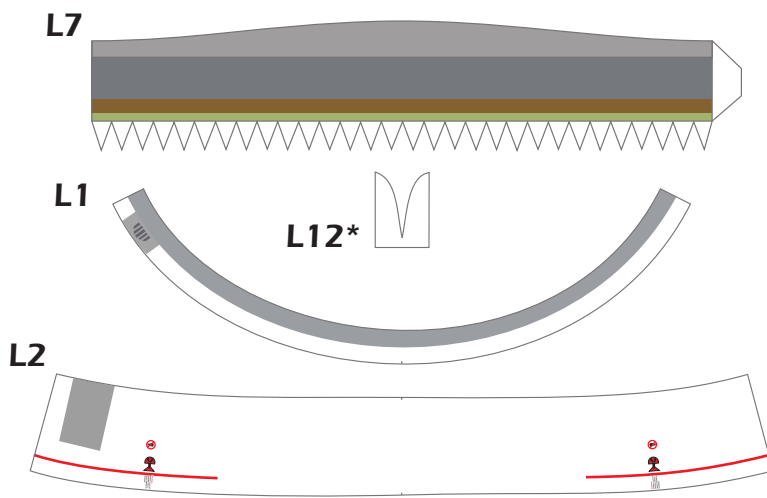
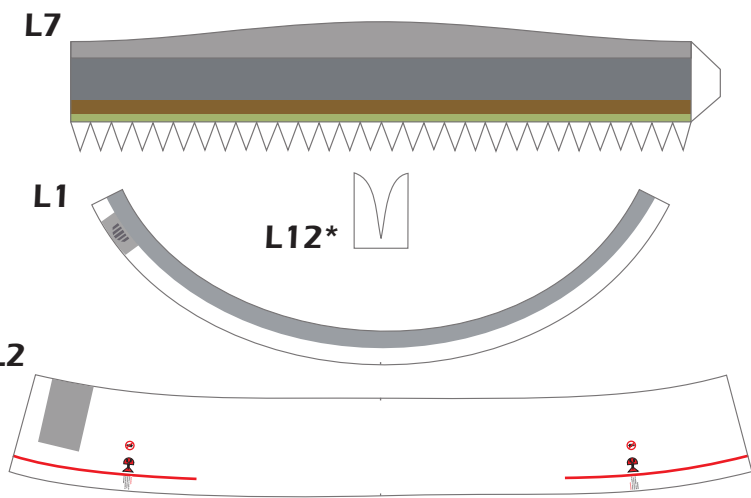
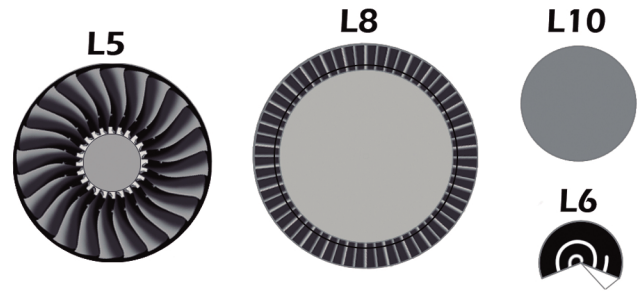
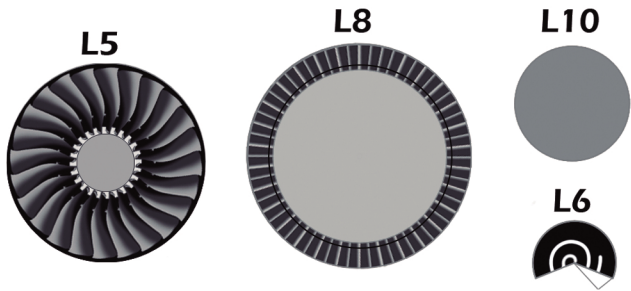

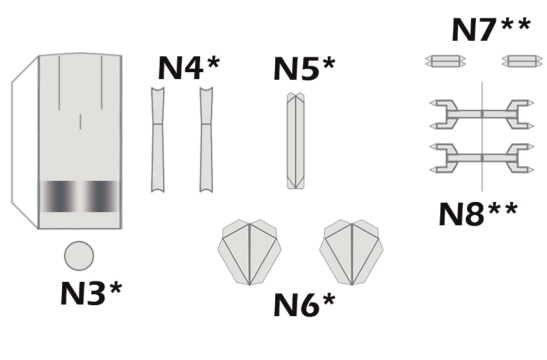
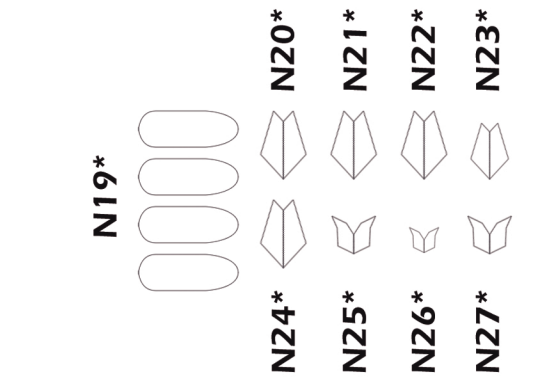
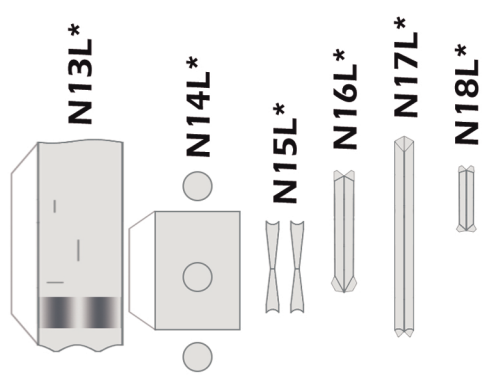
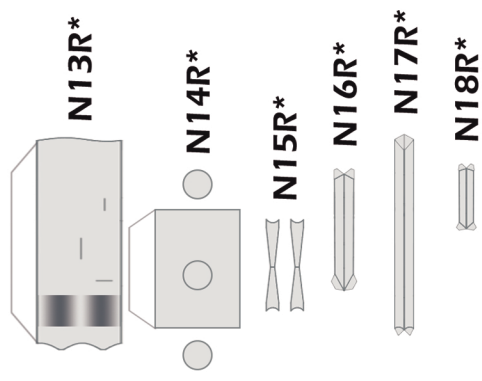
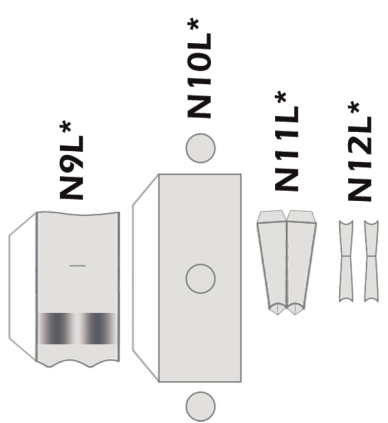
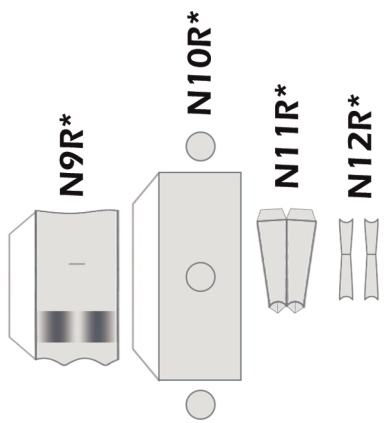
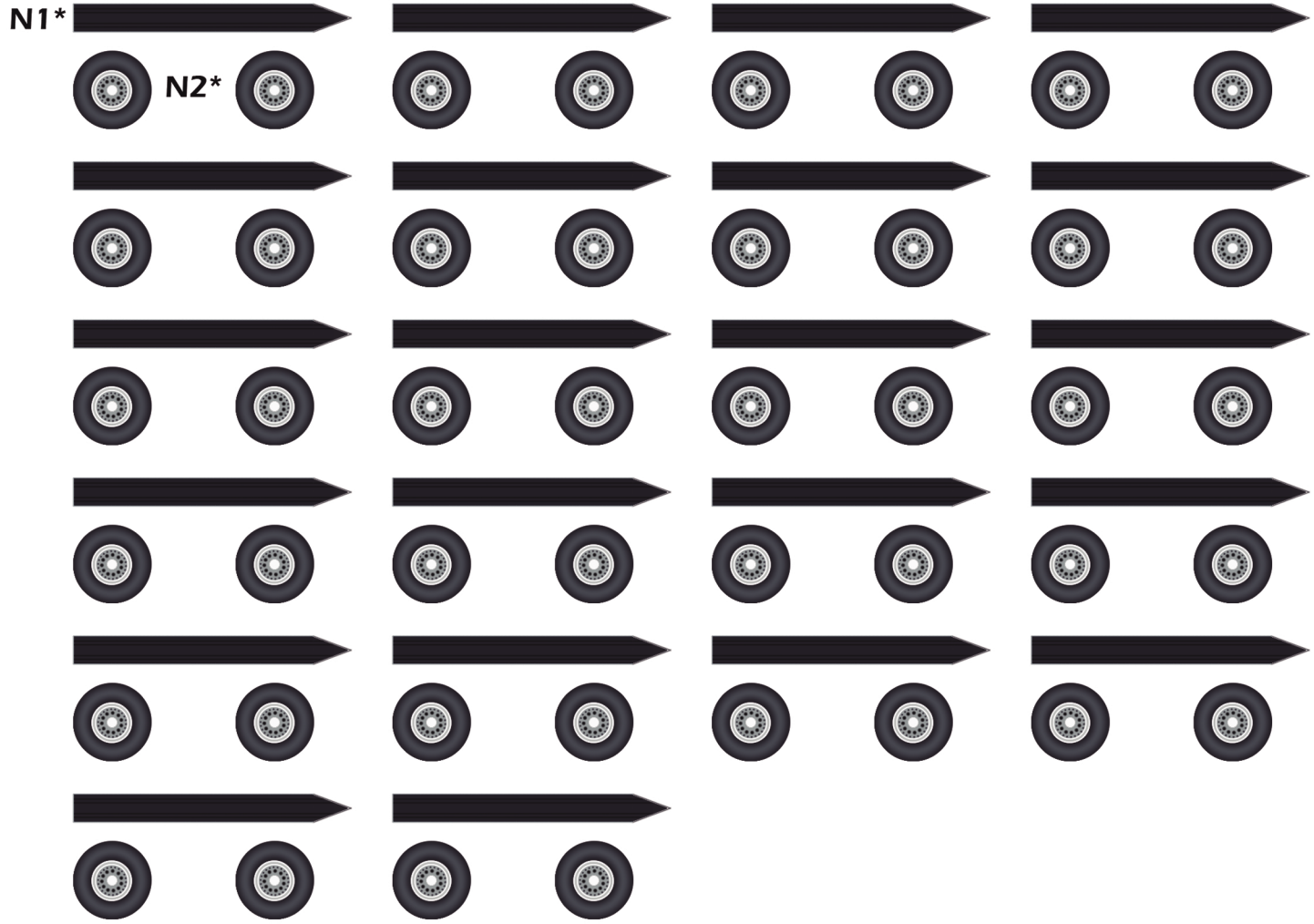

O3L

O1

O2R

**HERMERCRAFT**

DESIGNED BY EDWIN RODRIGUEZ

O3R

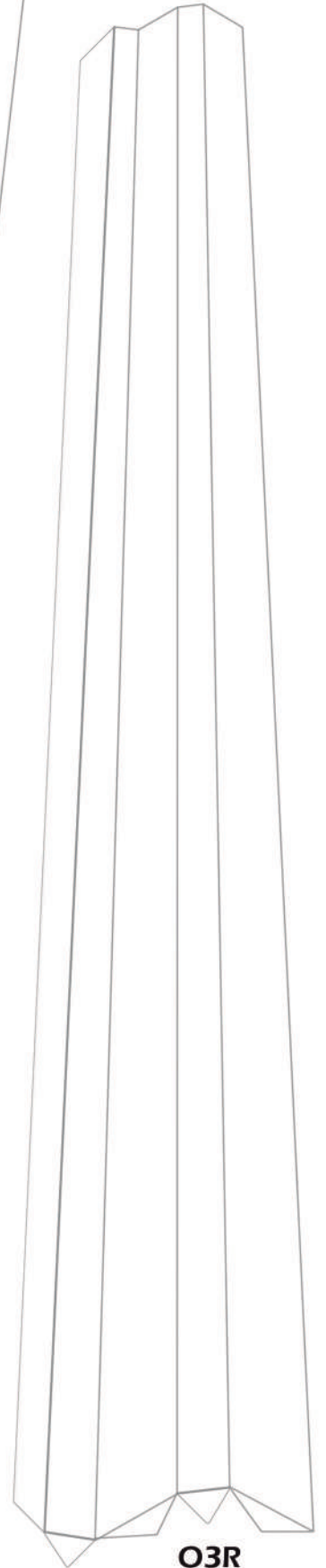
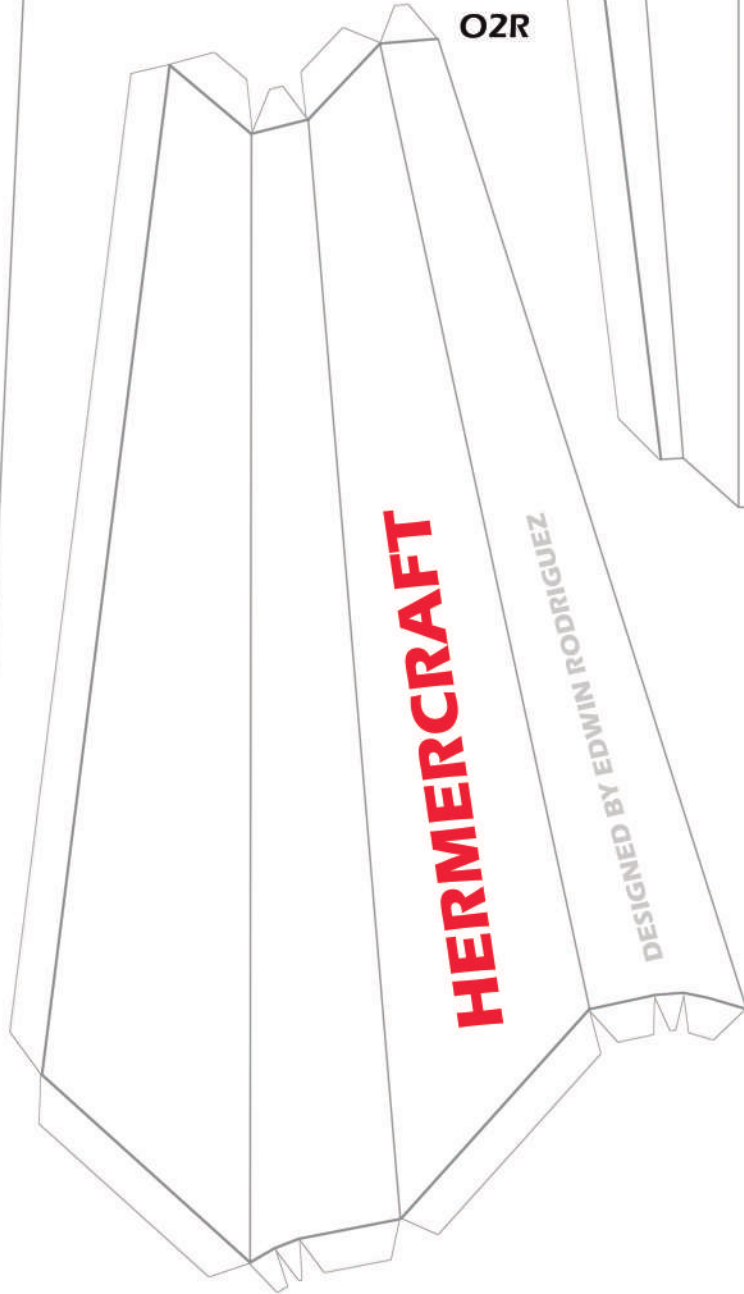
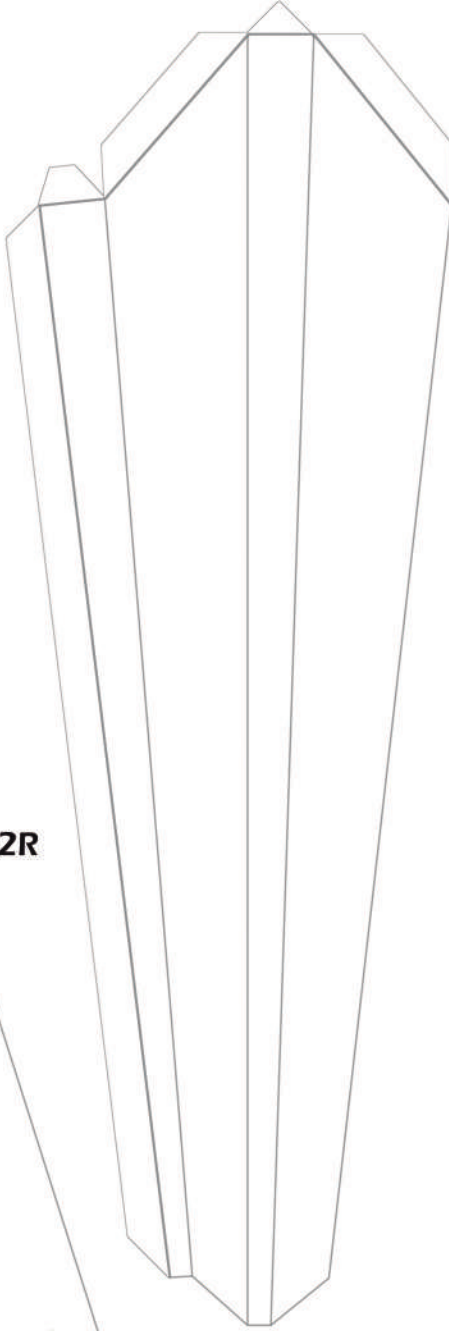
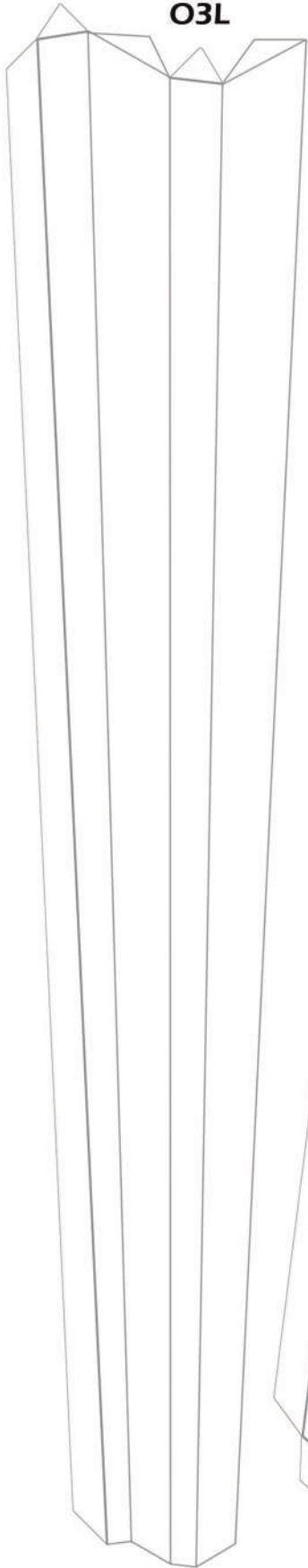

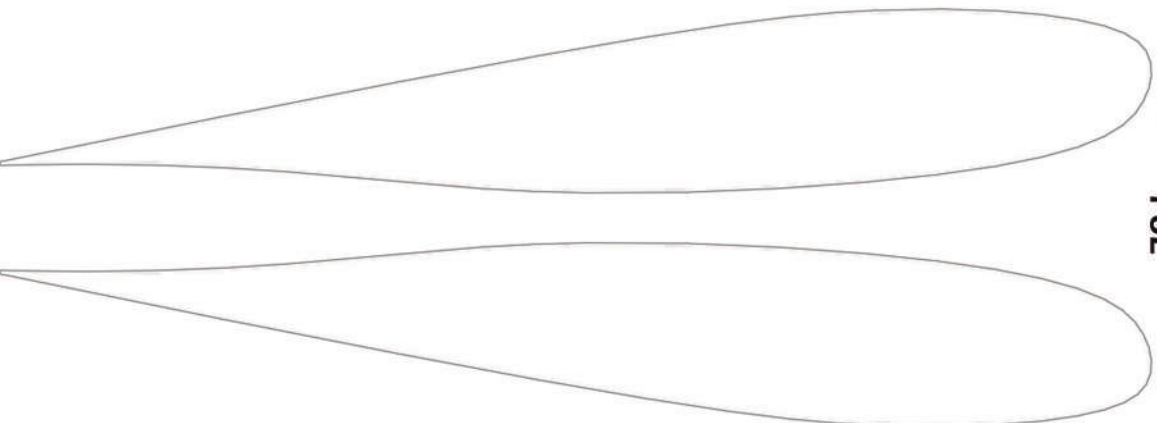
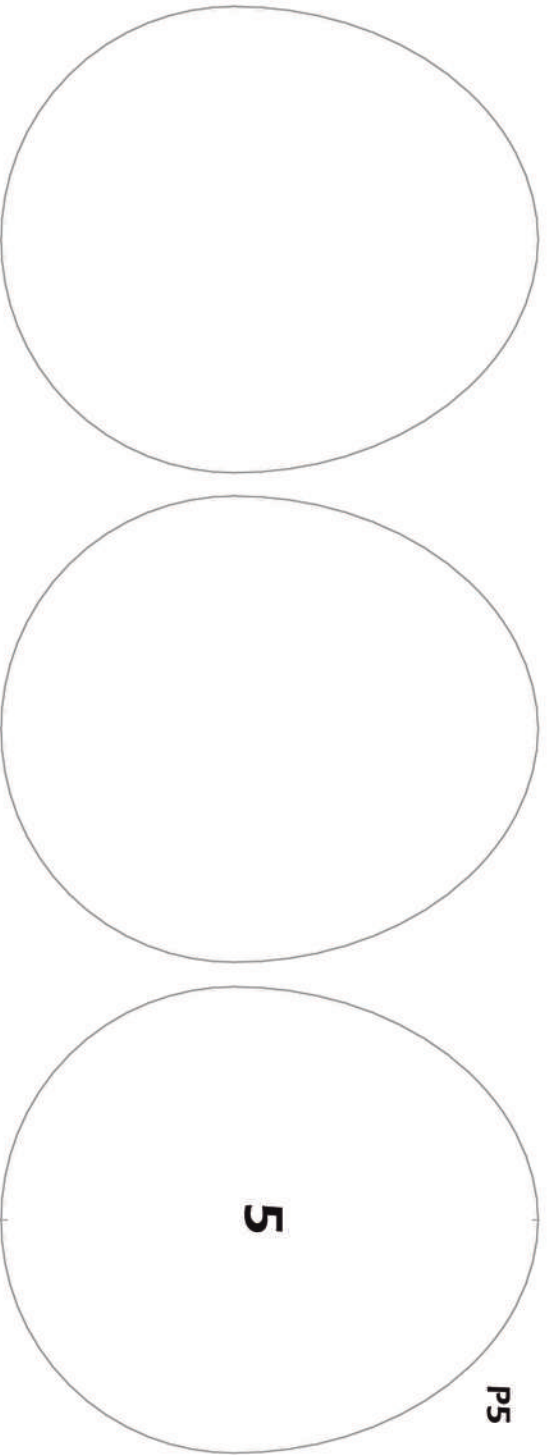
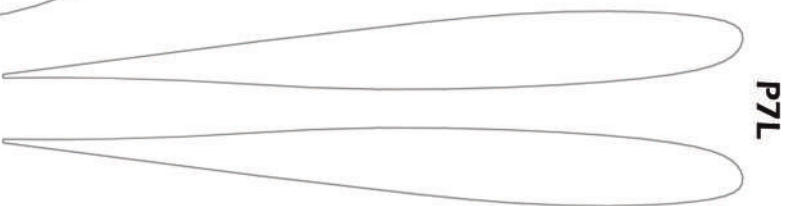
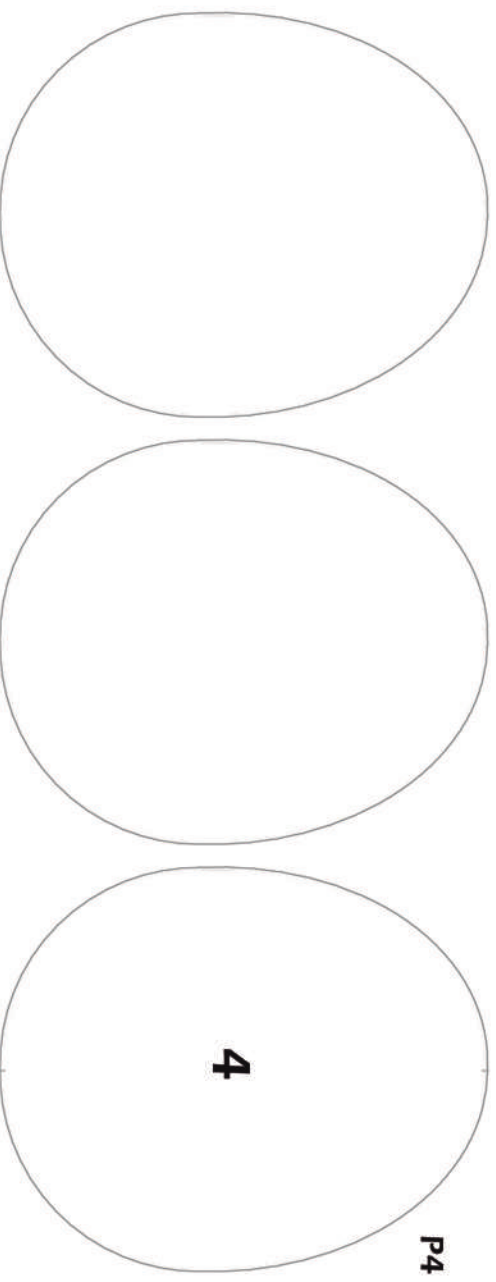
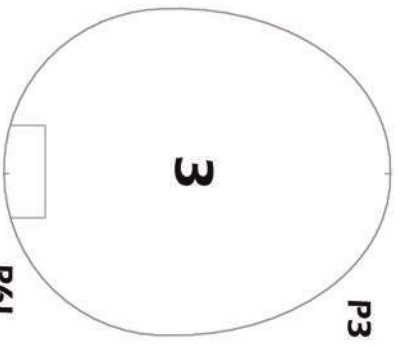
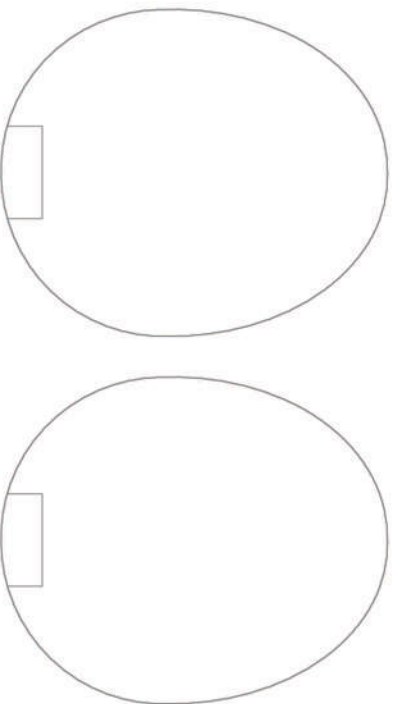
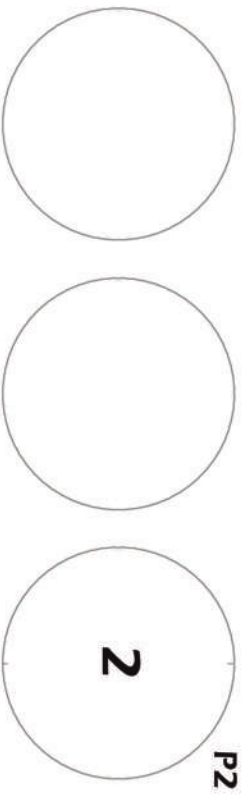
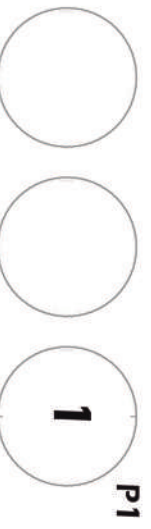



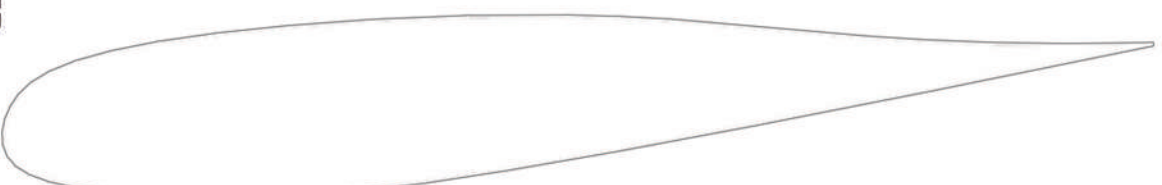
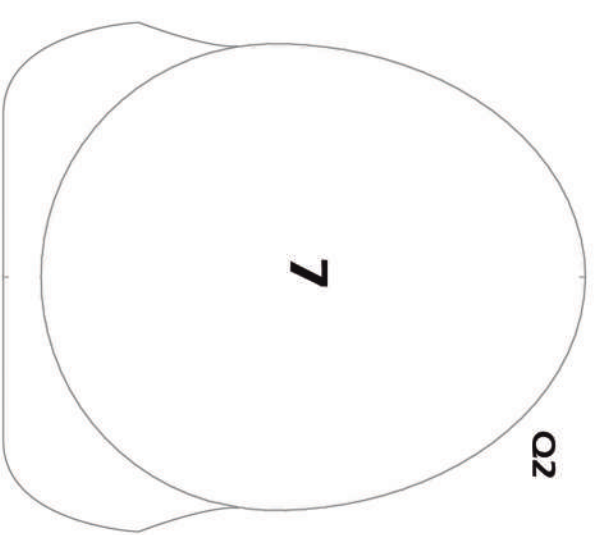
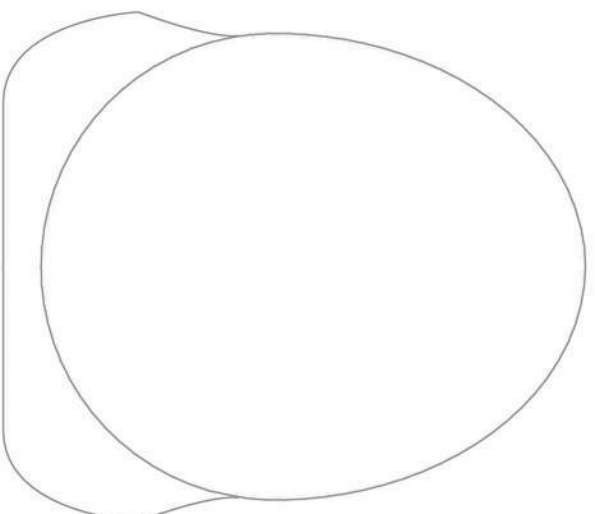
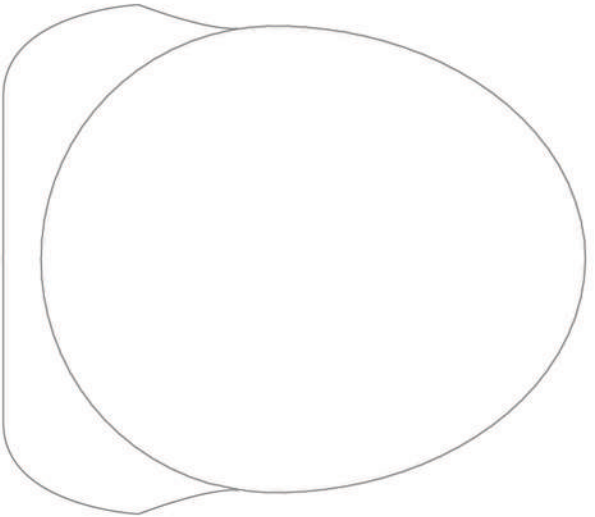
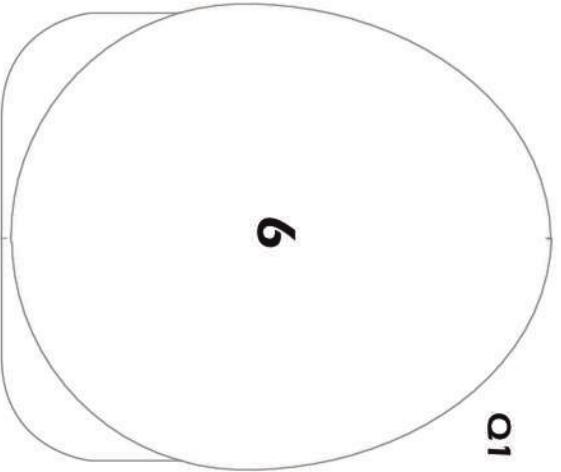
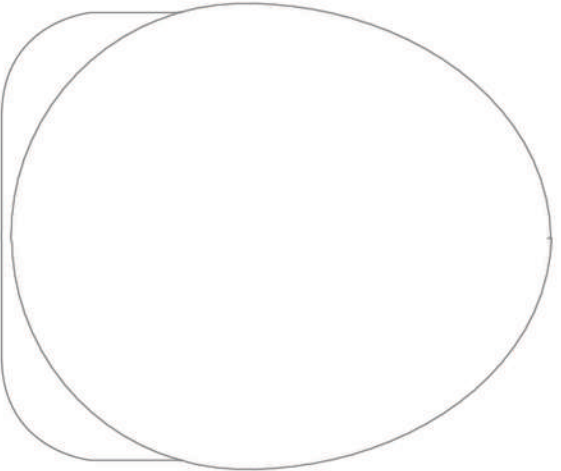
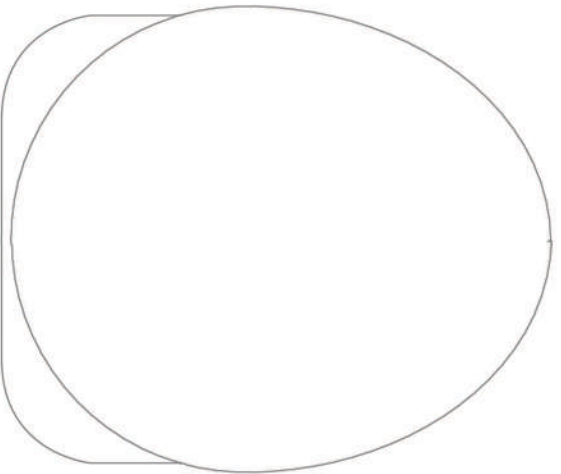

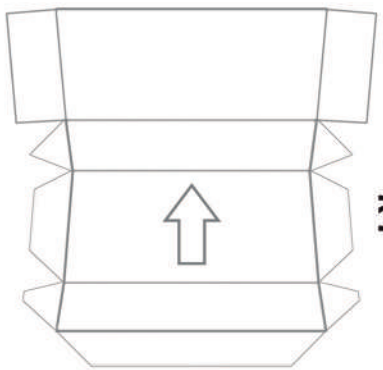
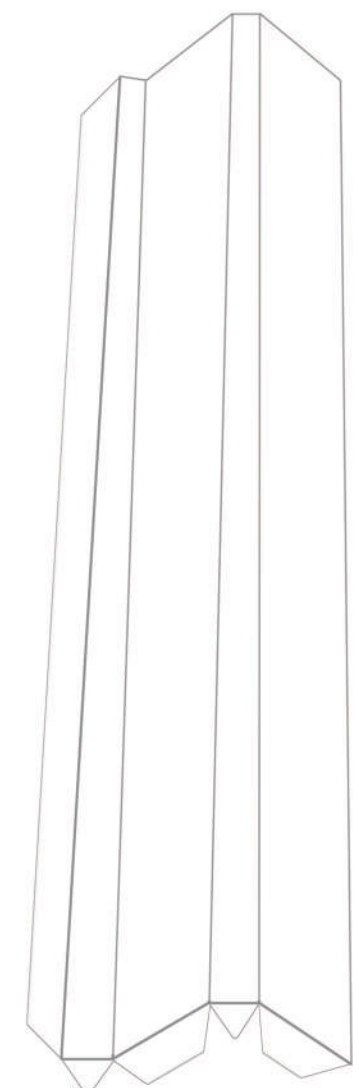
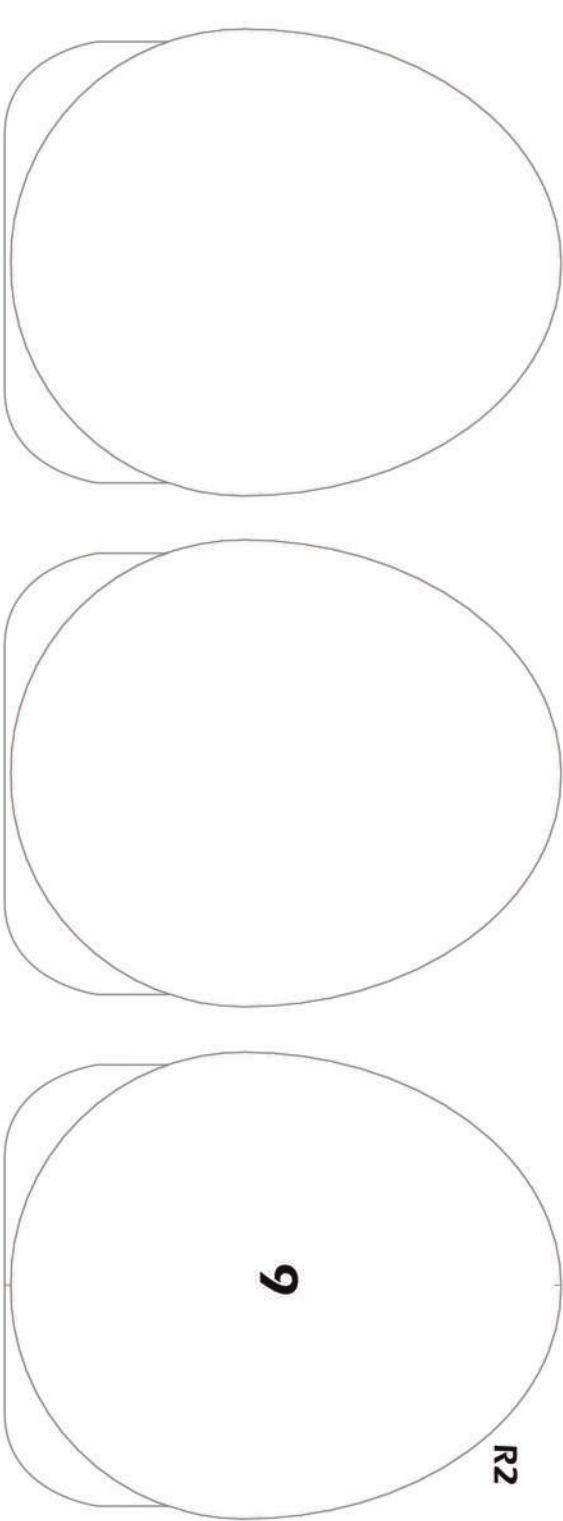
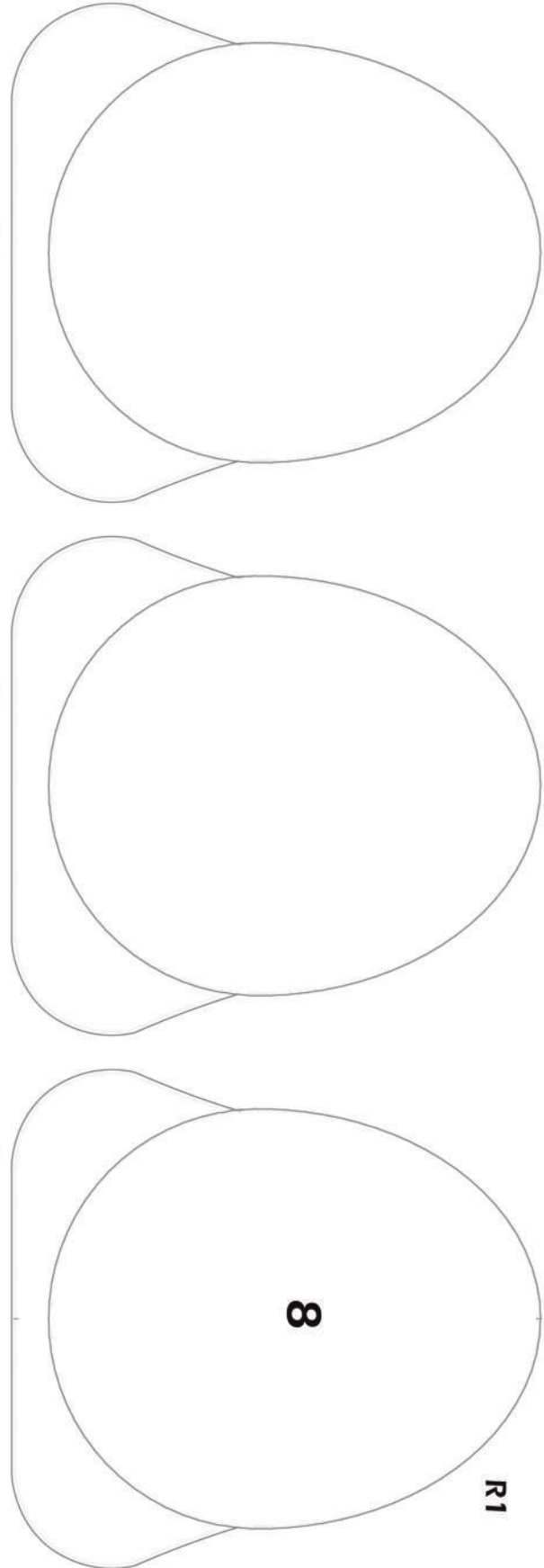

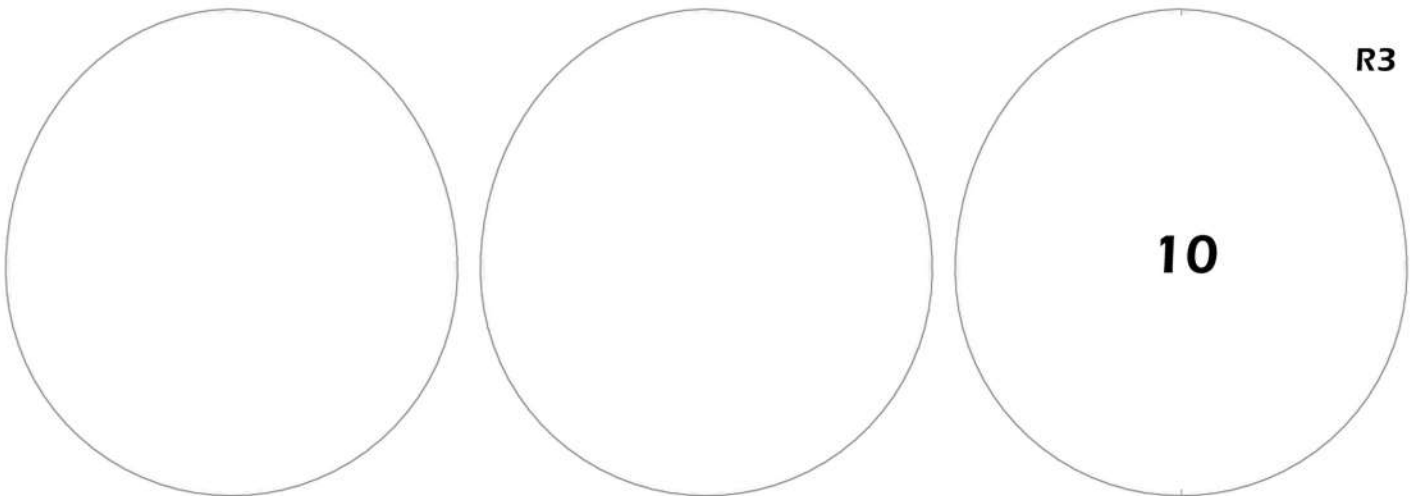

R3

10

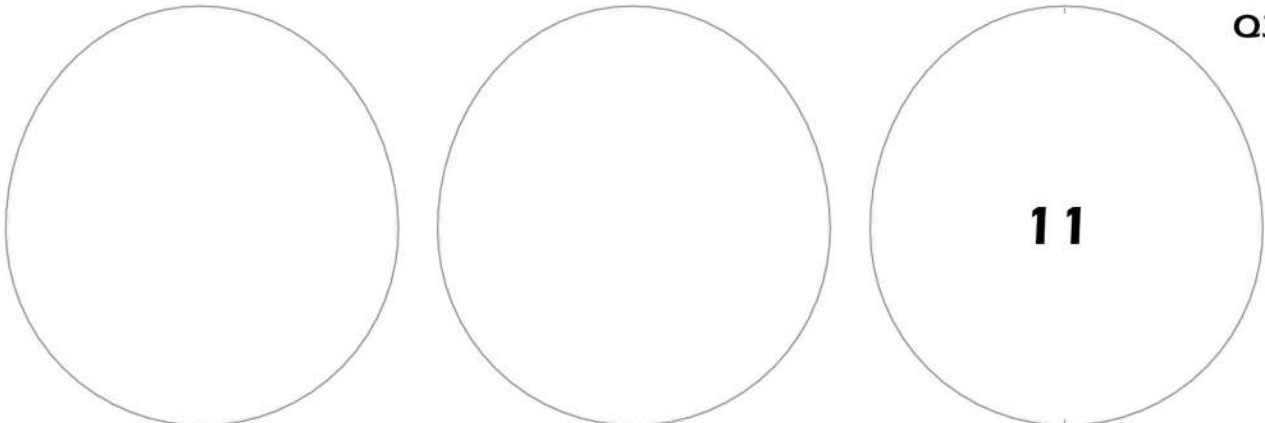

Q3

11

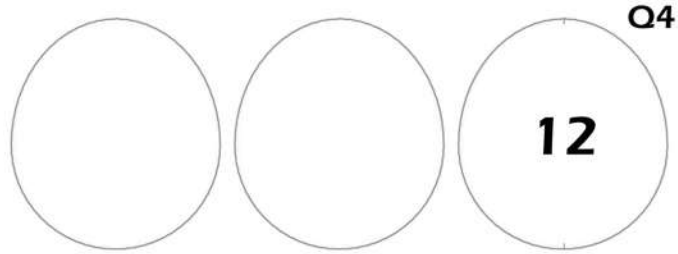

Q4

12



O2L

**FREE MODEL, DO NOT SELL THE FILES!!!**

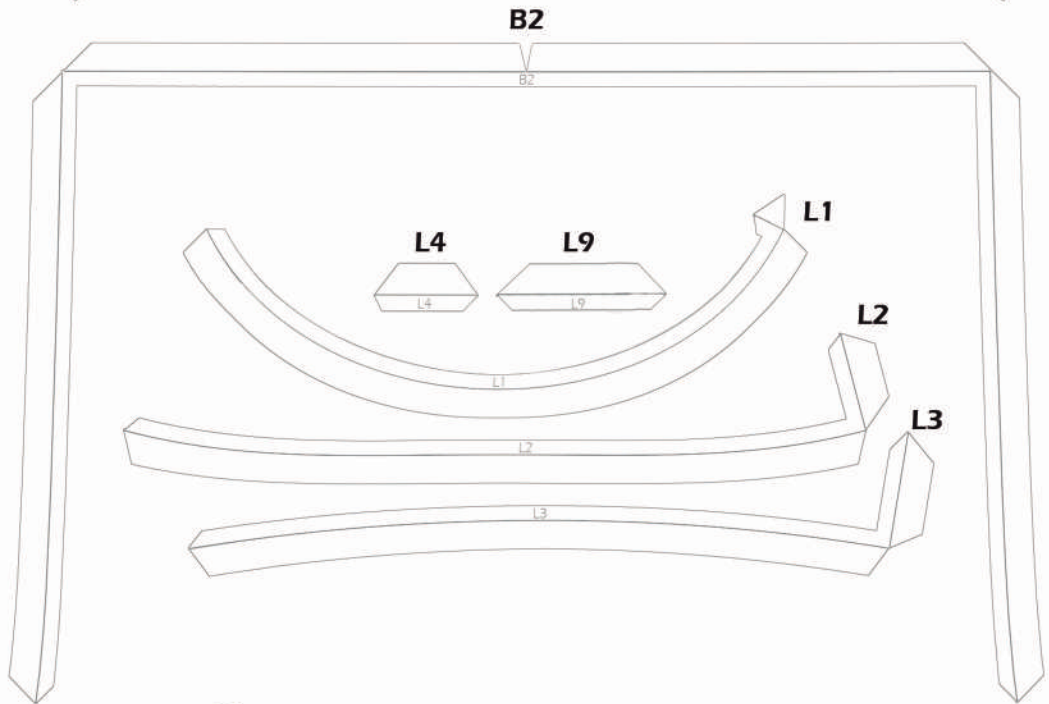
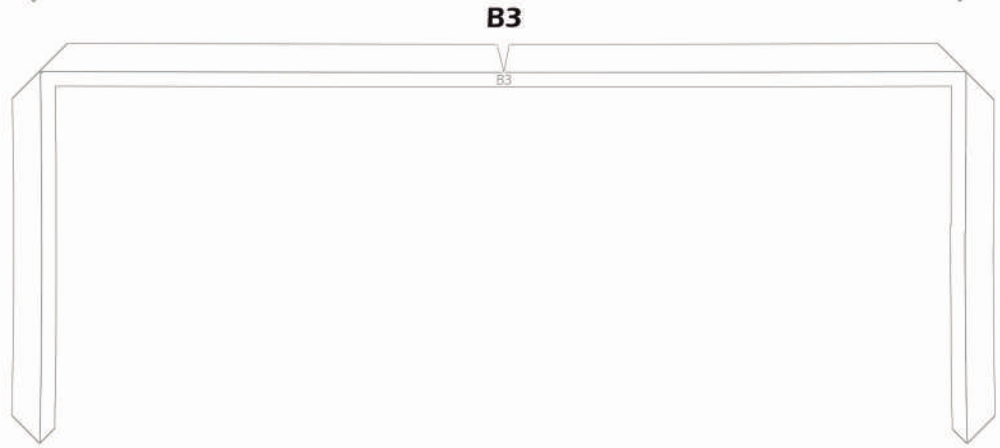
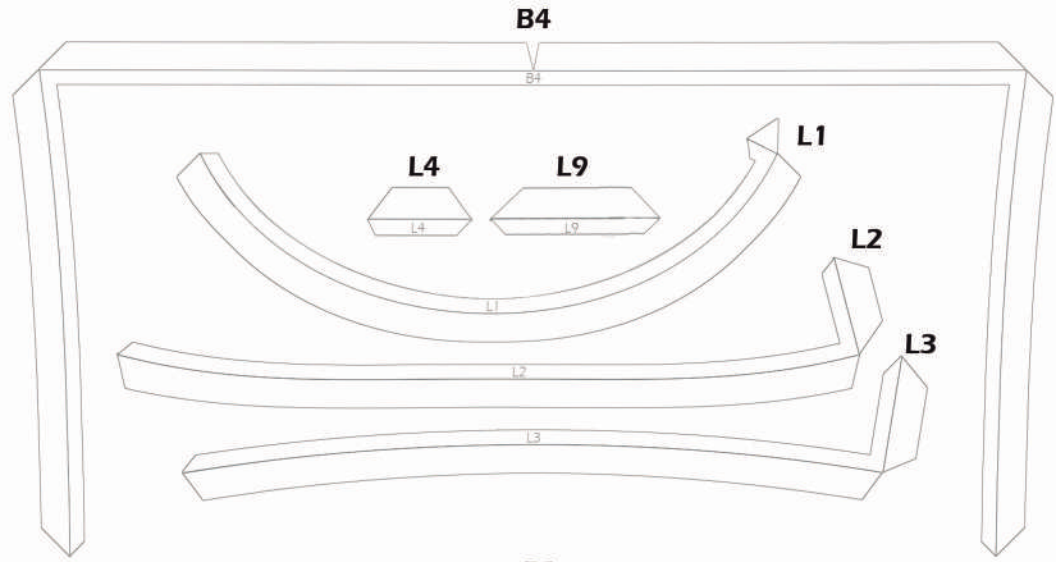
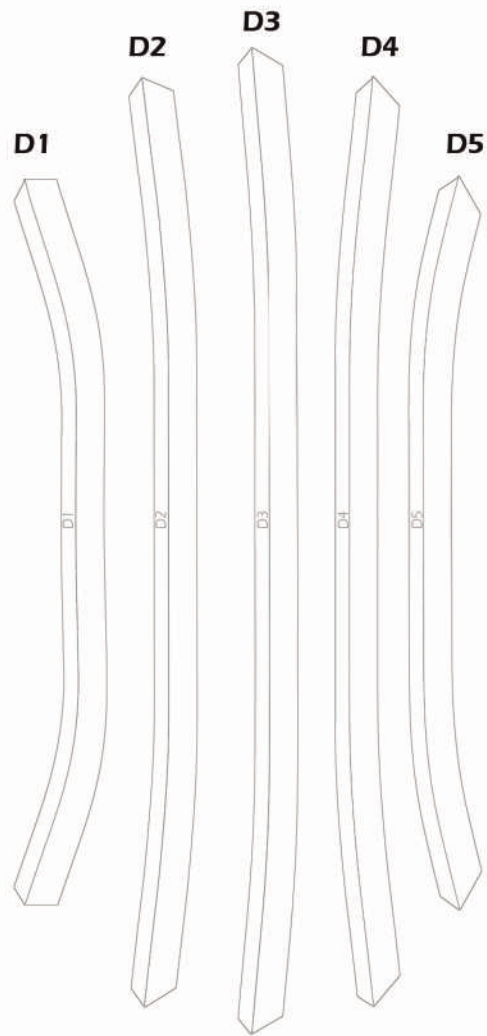

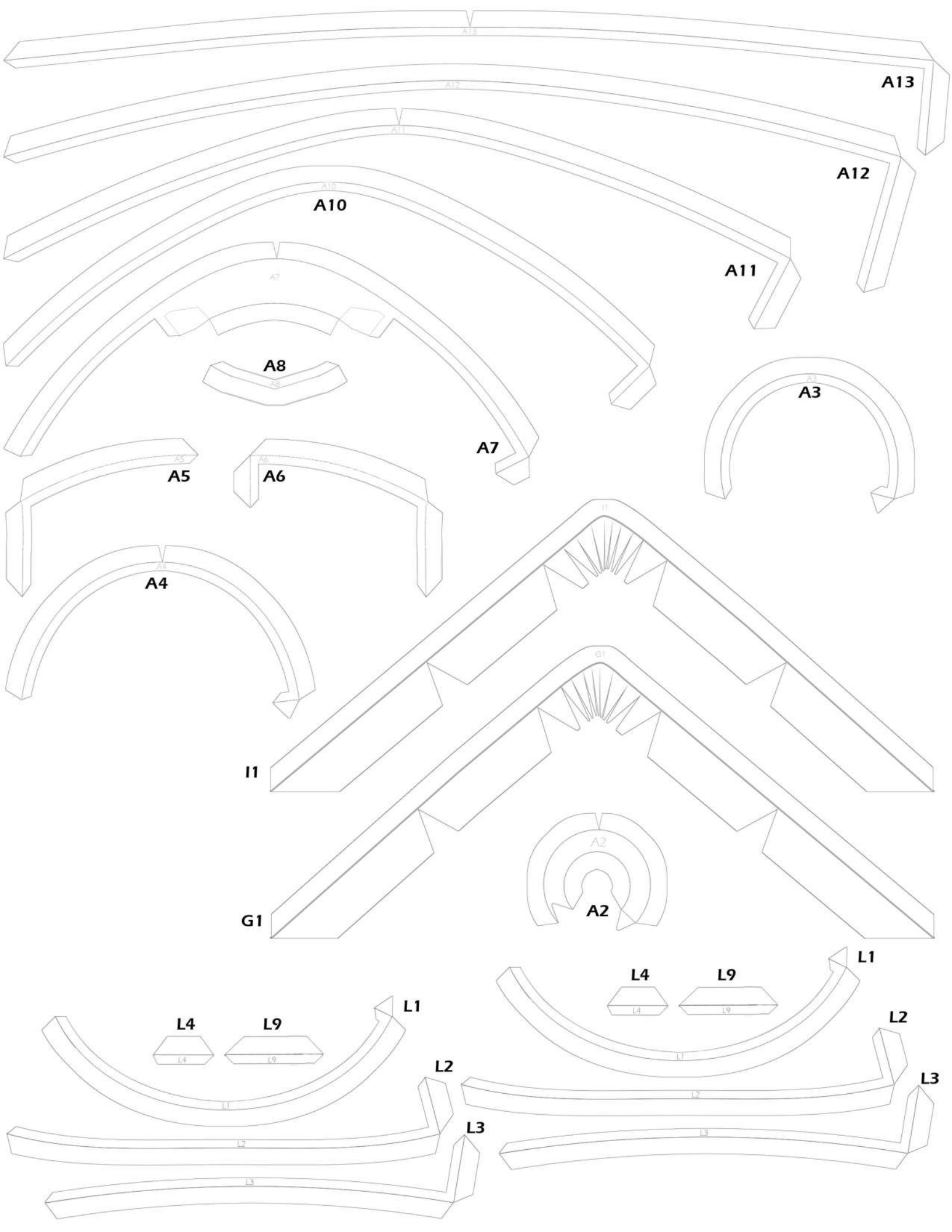

K15L K16L

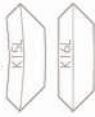

K11L K12L



K7L K8L



K4L K5L



K1L K2L



C7

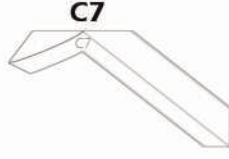

C6

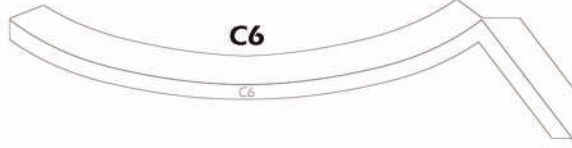

C5

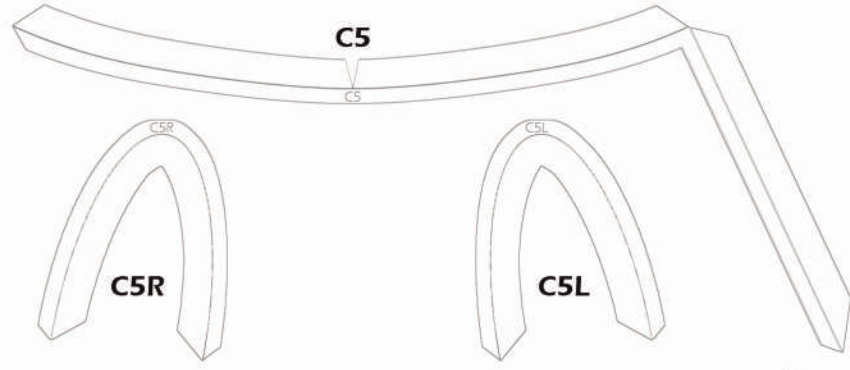

C5R

C5L

C4

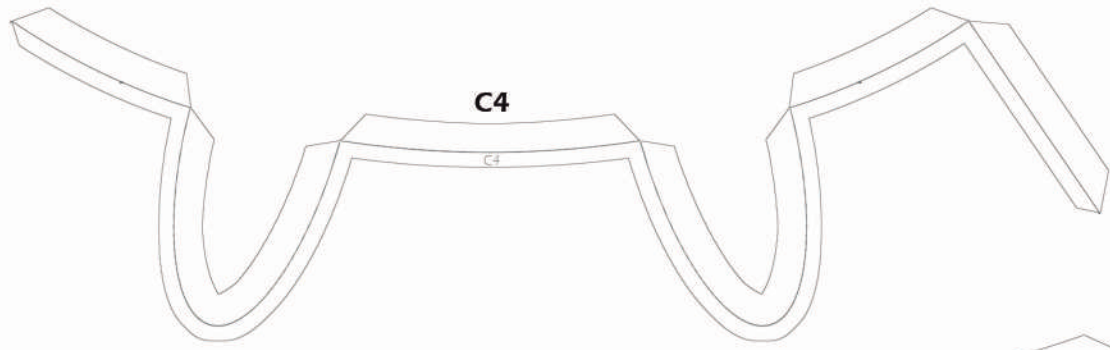

C3

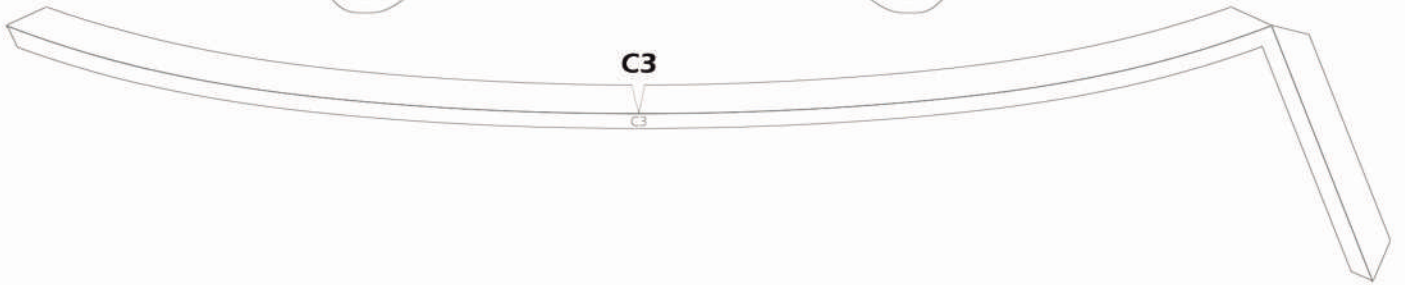

C2

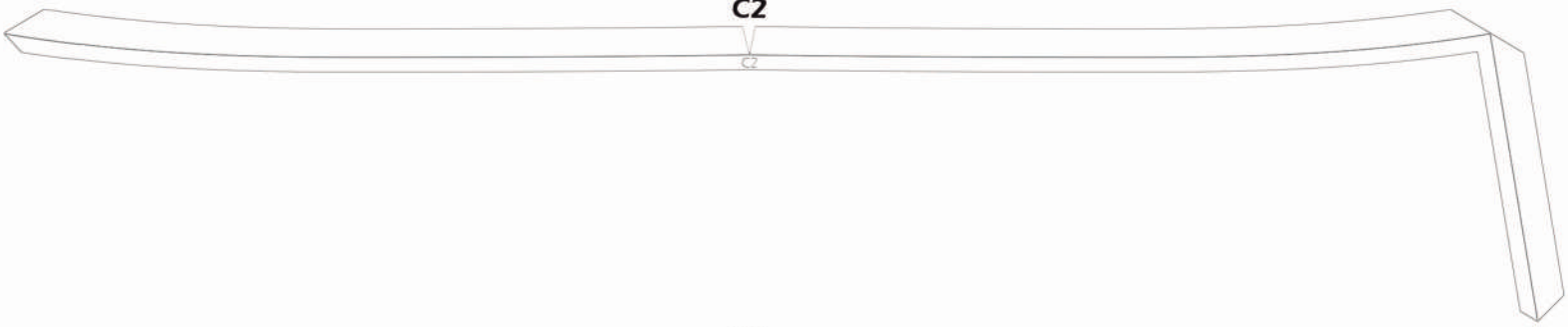

C1

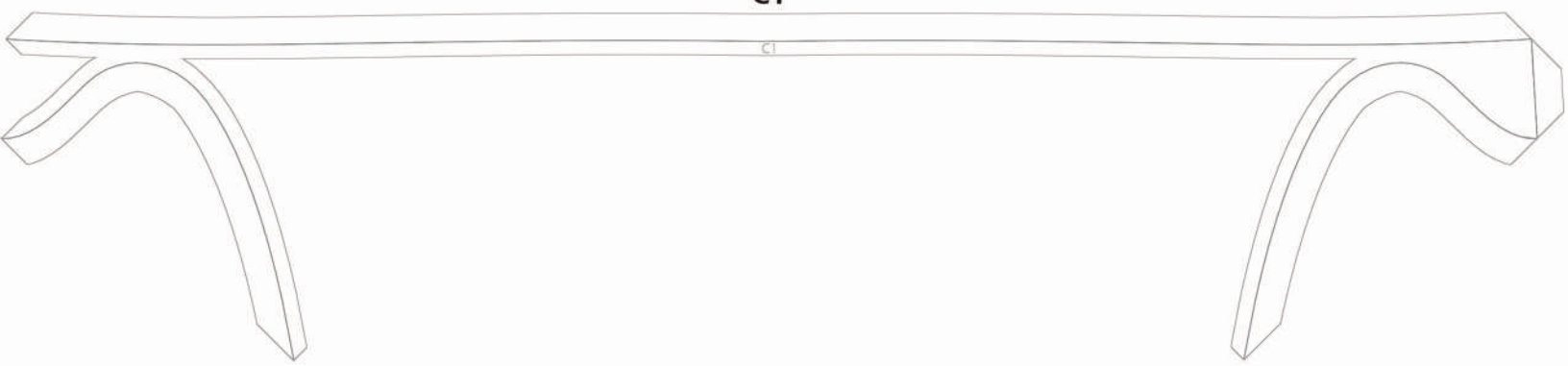

K1R K2R



K4R K5R



K7R K8R



K11R K12R



K15R K16R

