

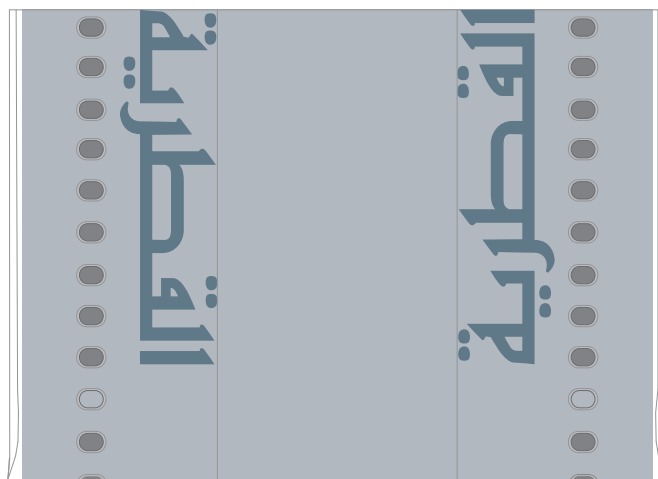

- B5\* B7\* B9\*
- B6\* B8\* B10\*

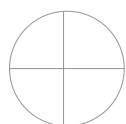

B3

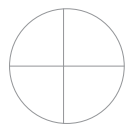
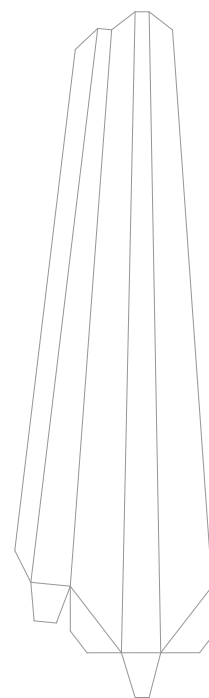

B13



B2



B1



B12R

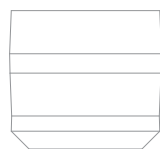

B11



B12L

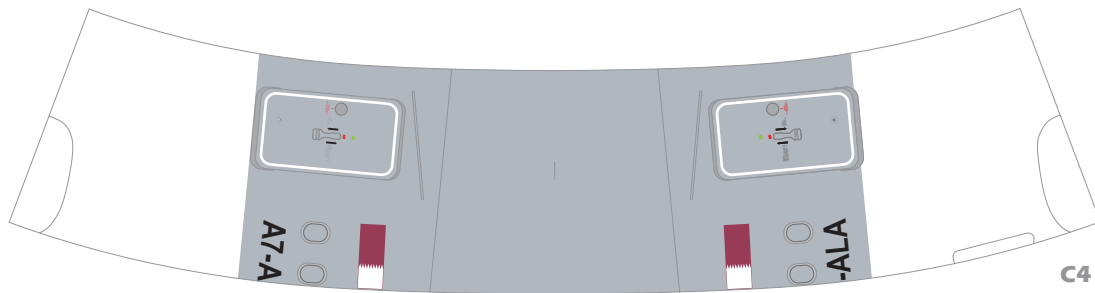

C4

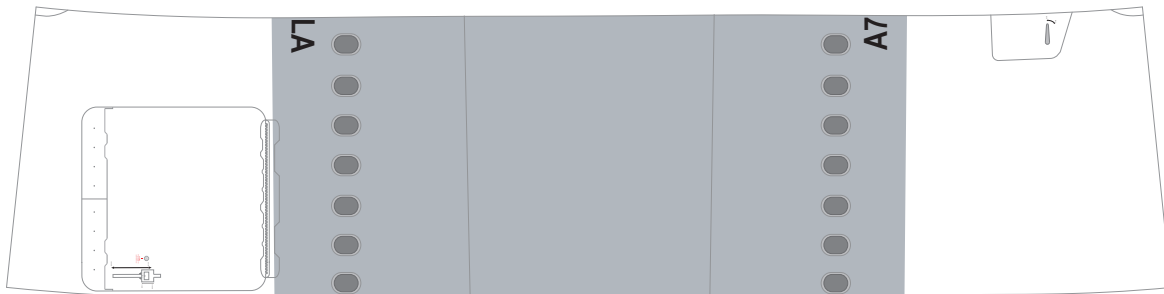

C3



C2

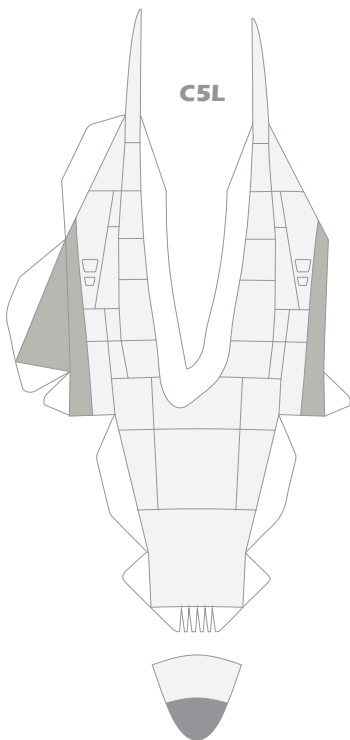

C5L

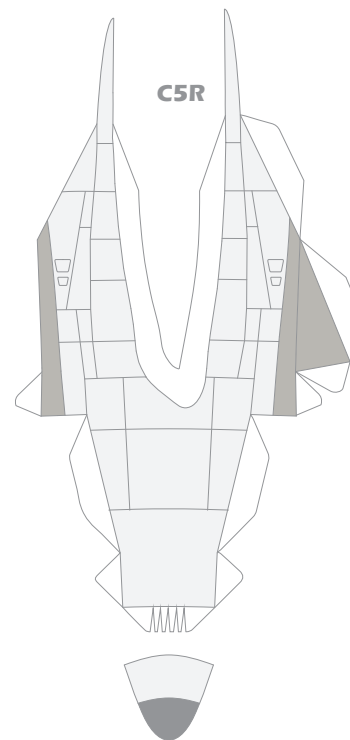

C5R

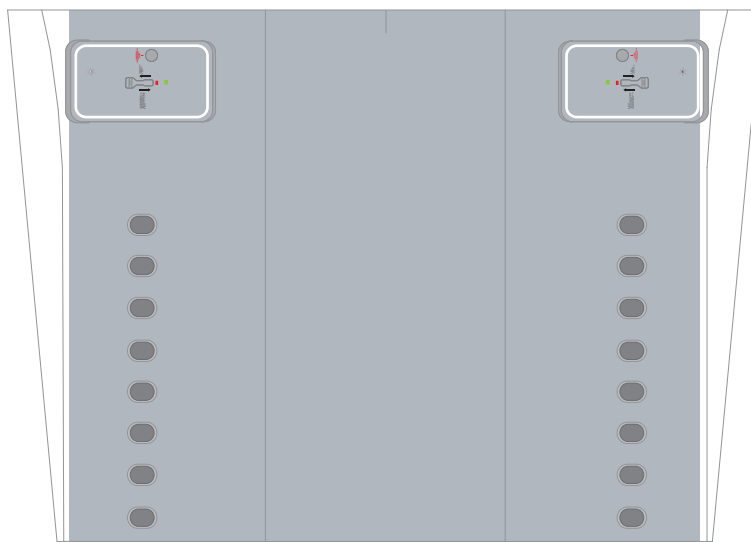

C1

C6L

C6R

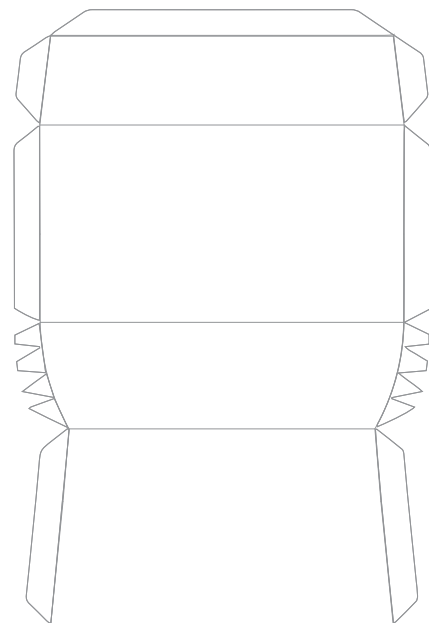
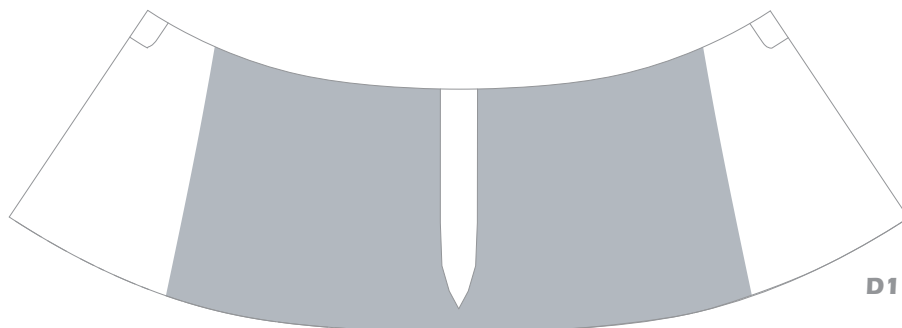
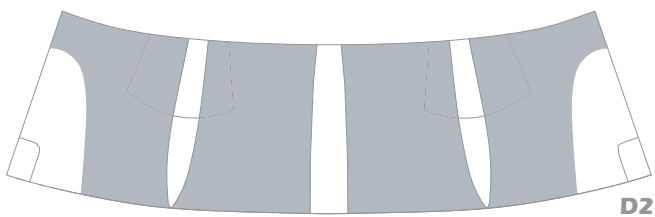
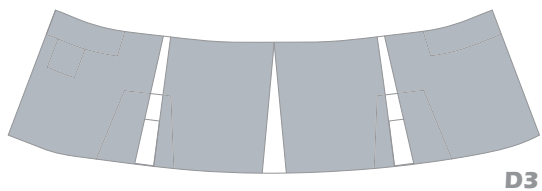
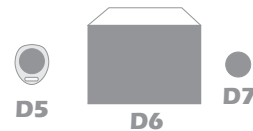
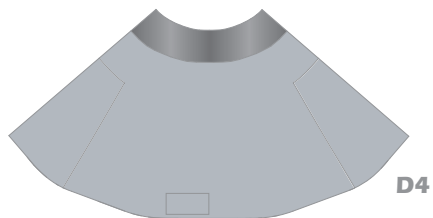
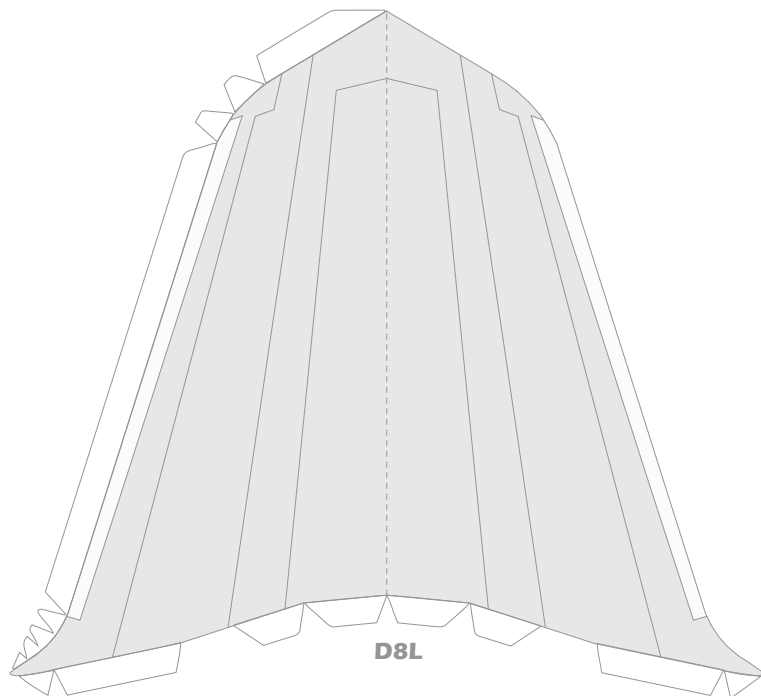
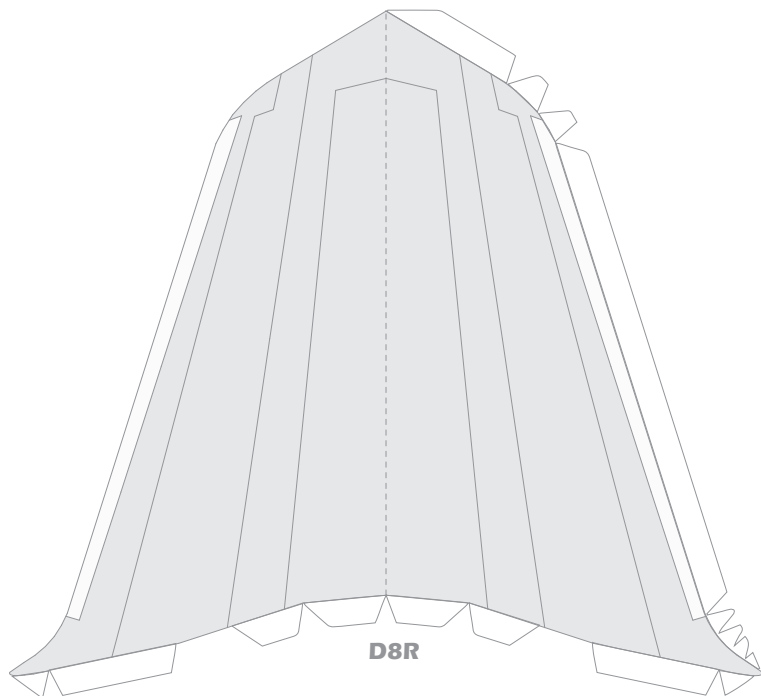

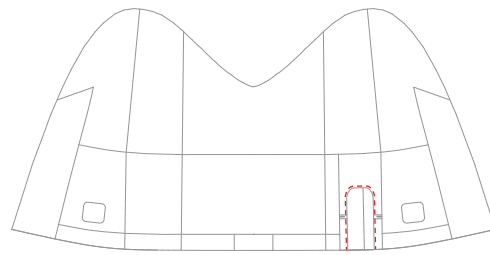
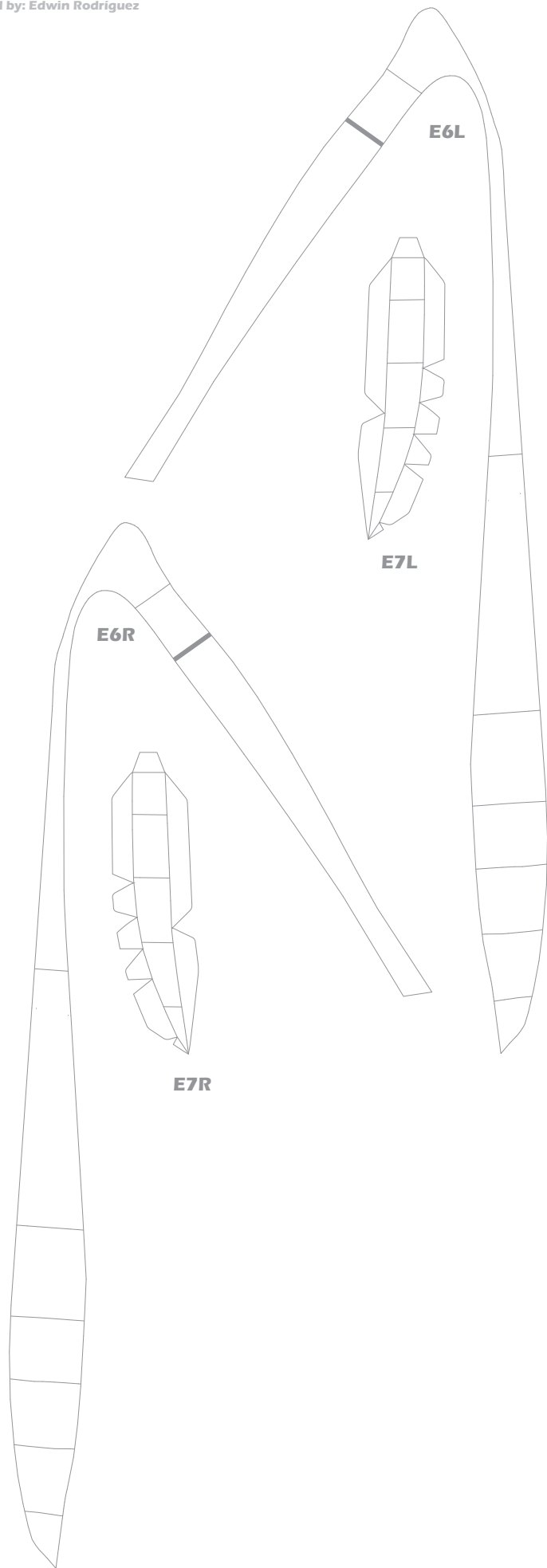

E5

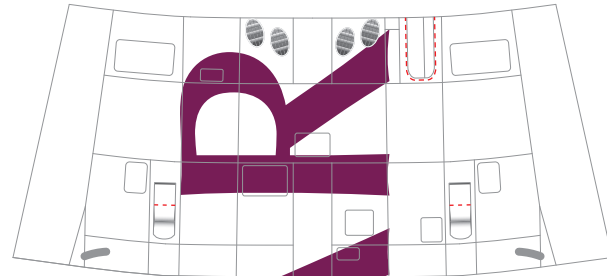

E4



E3



E2

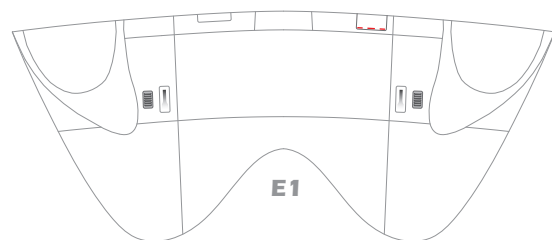

E1

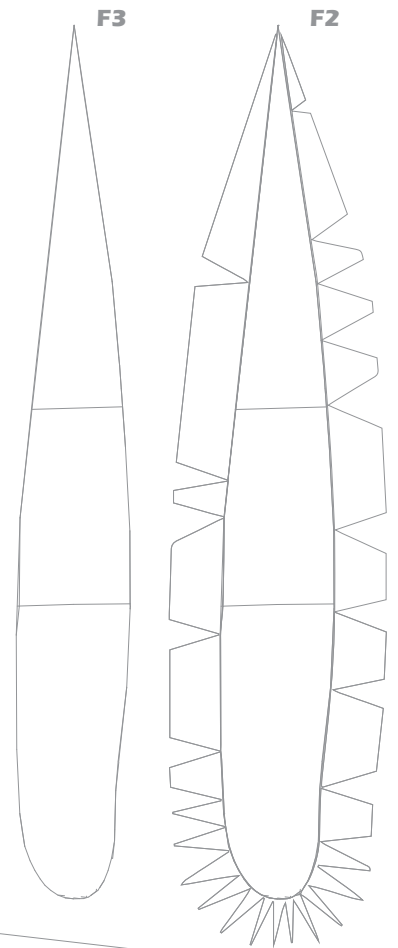
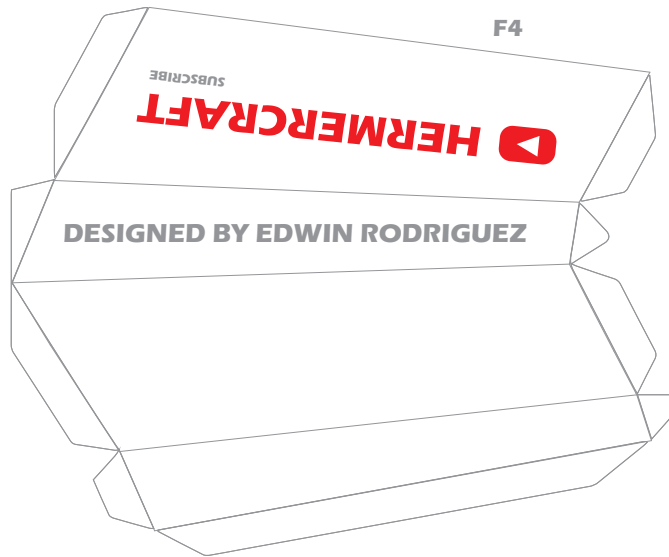
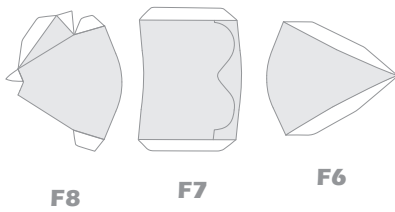
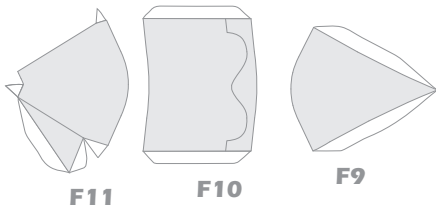
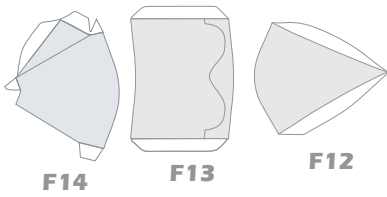
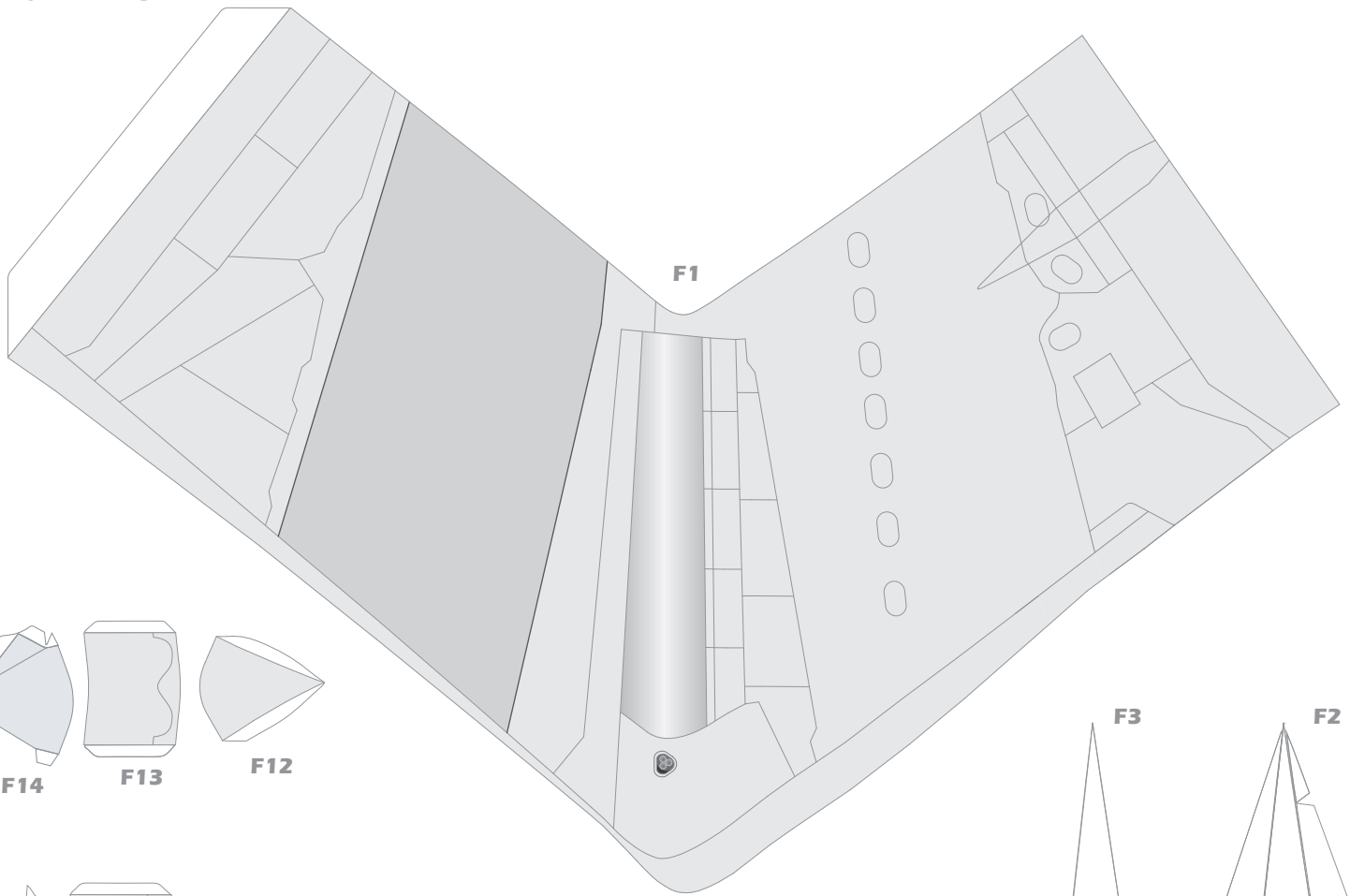

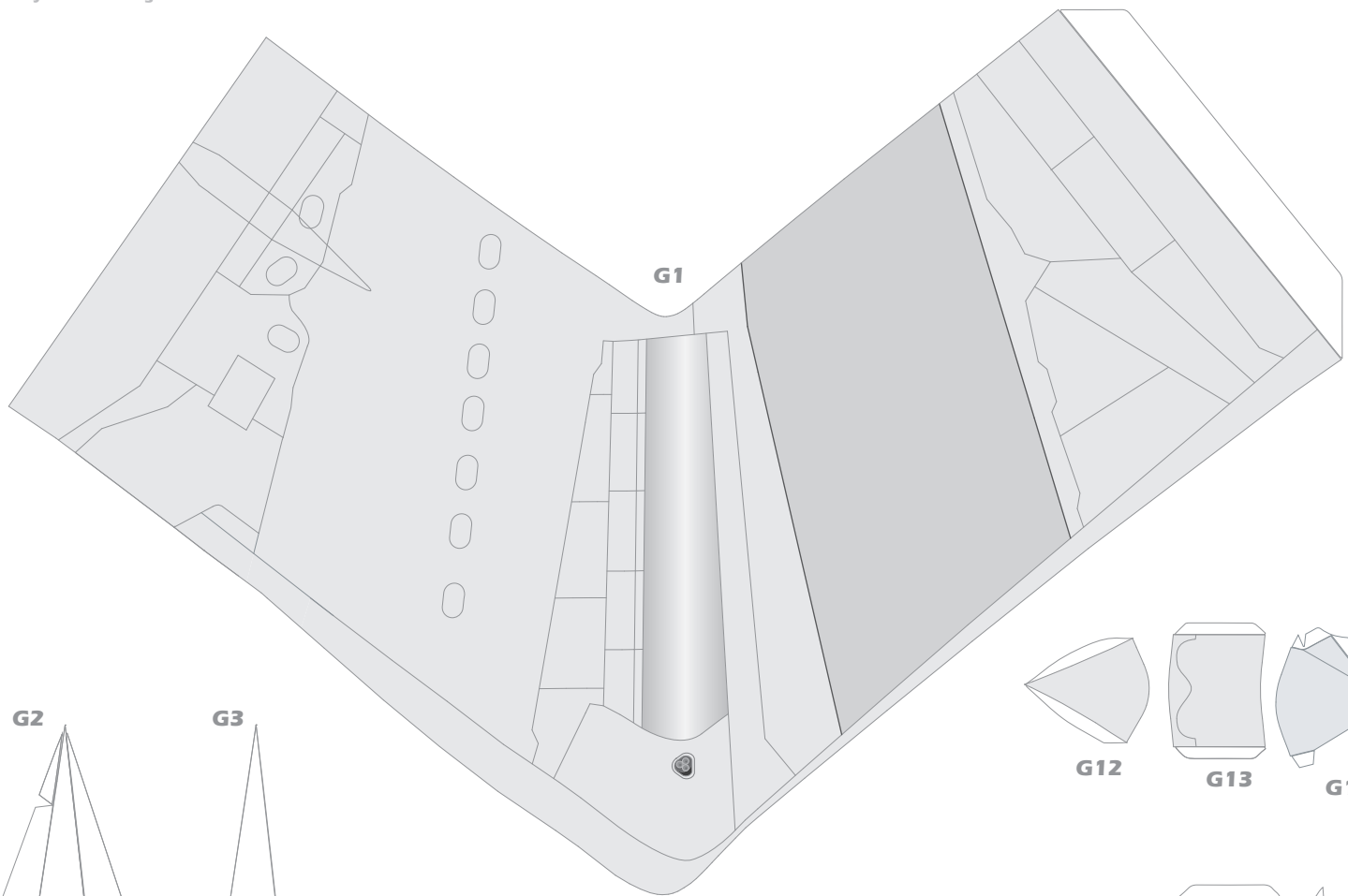

G2

G3

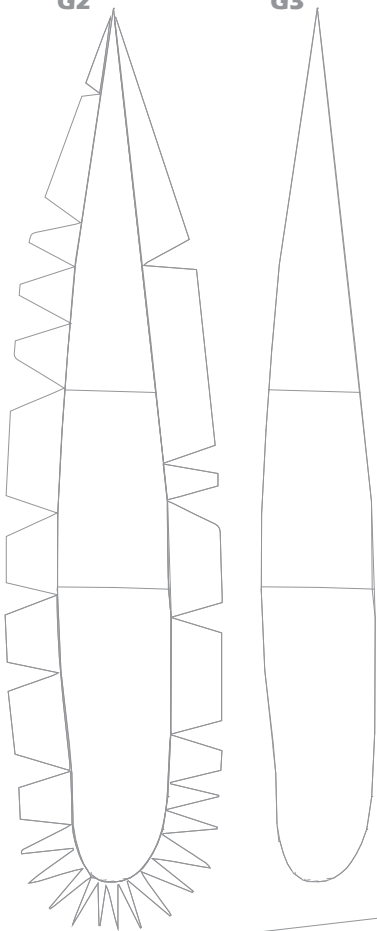

G1

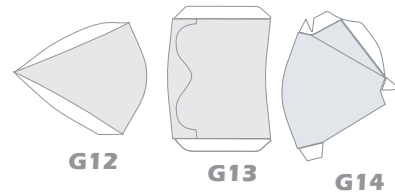

G12

G13

G14

G4

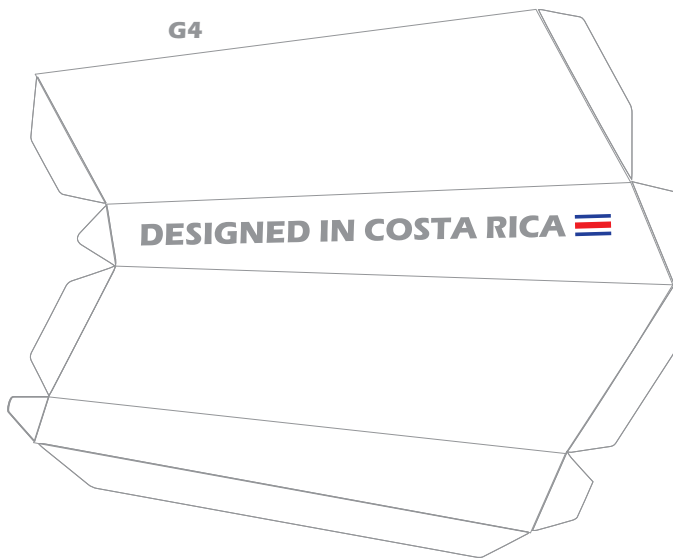

DESIGNED IN COSTA RICA 

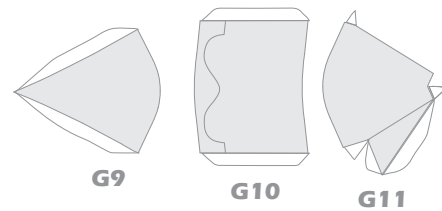

G9

G10

G11

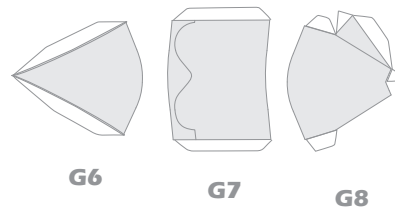

G6

G7

G8

G5

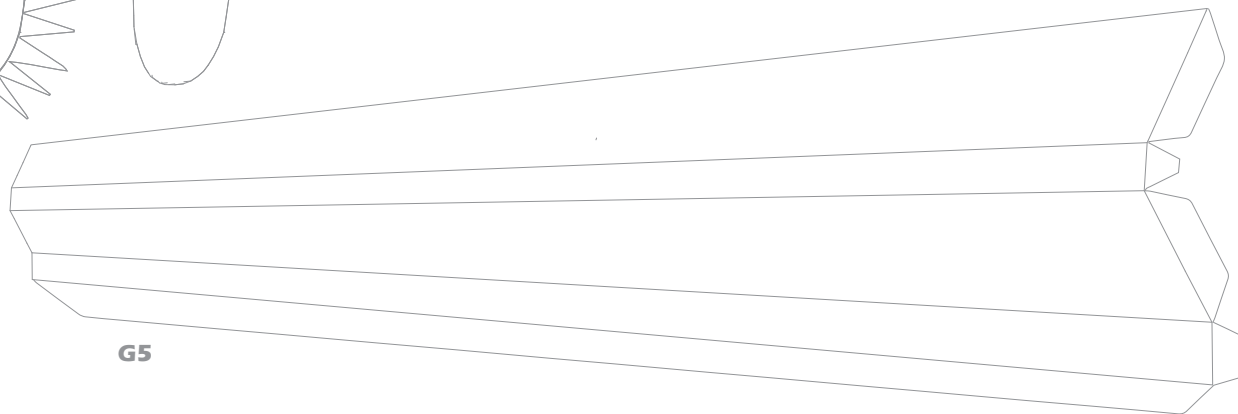

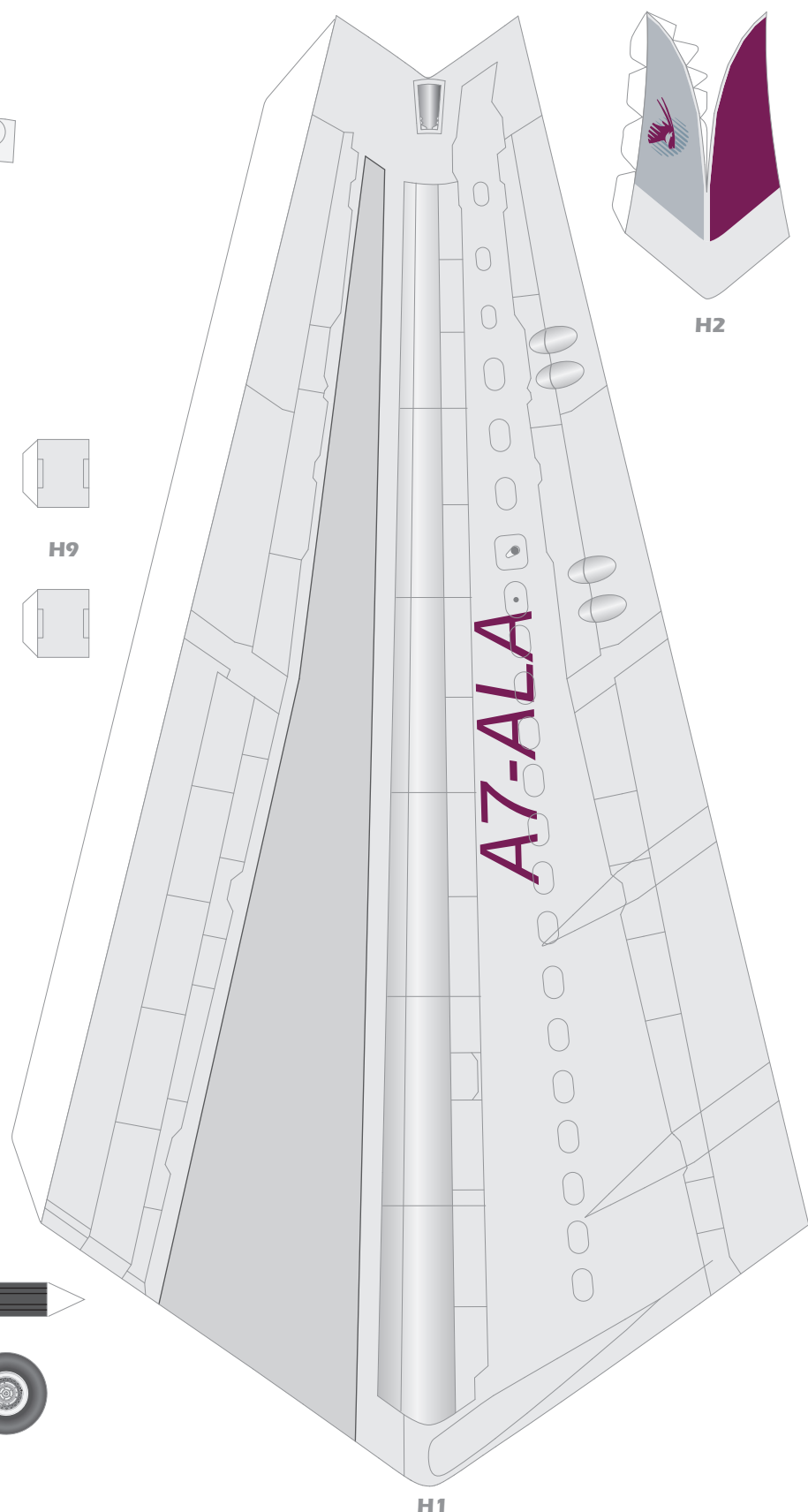

H4

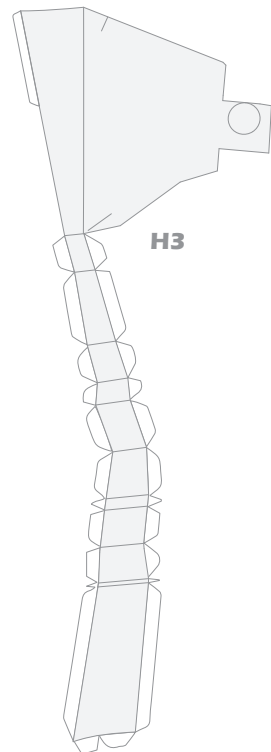

H3

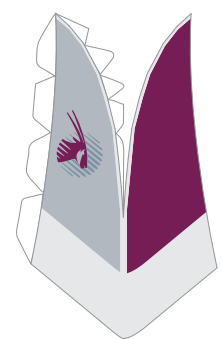

H2



H5



H9



H6



H8

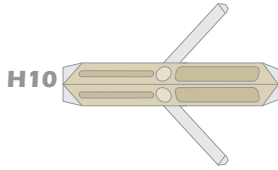

H10

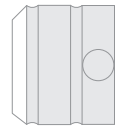

H7



H11



H12



H13

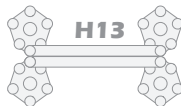

H13



H14



H15



H14



H15



H1



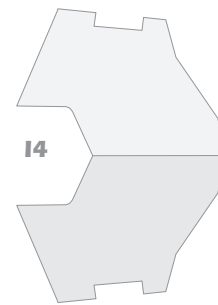
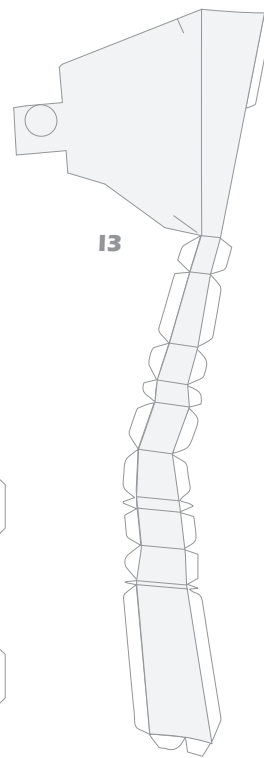
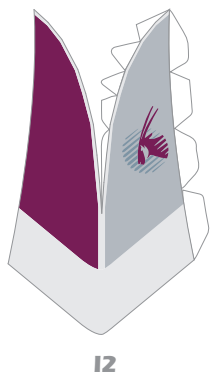
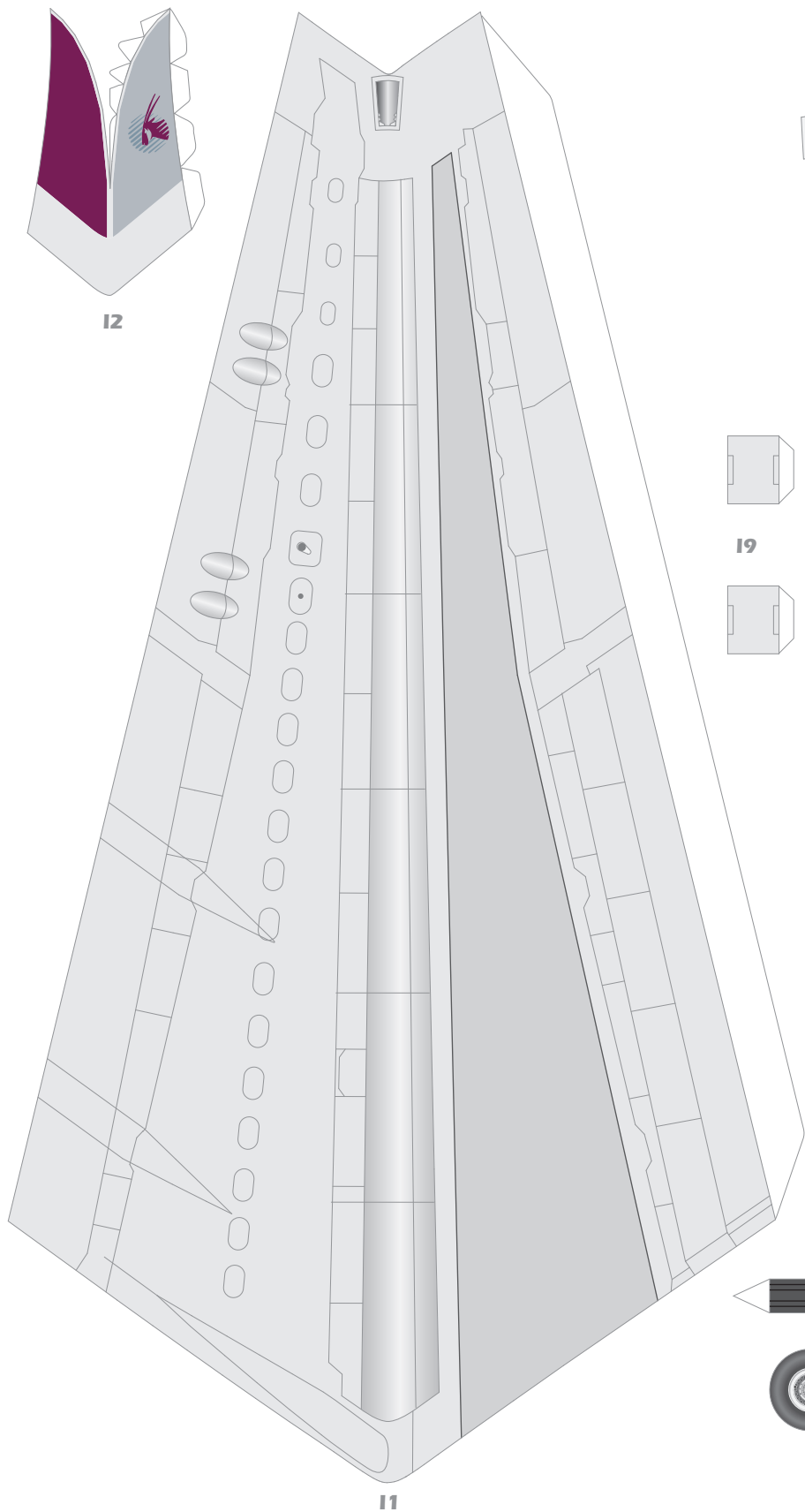

**19**

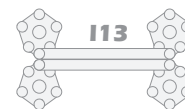
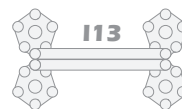
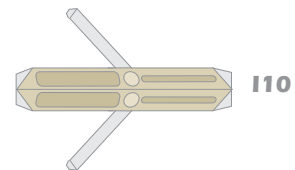
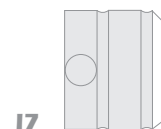

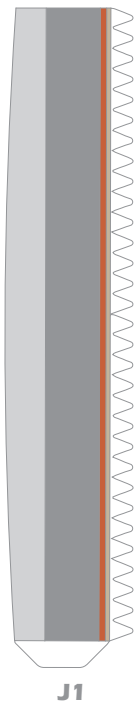

J1



J3

J4



J12

J13

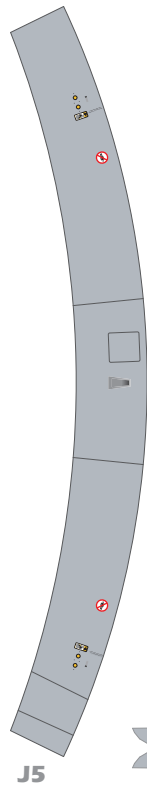

J5



J14

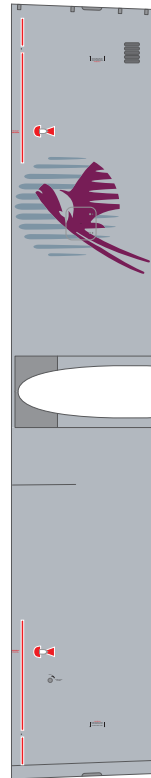

J6

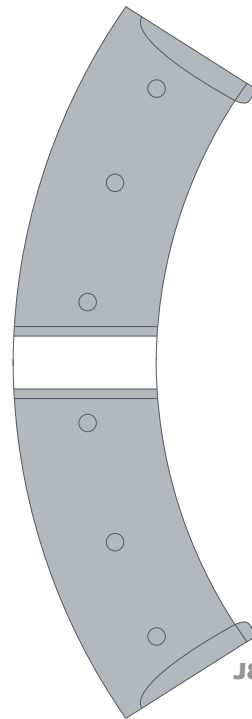

J8

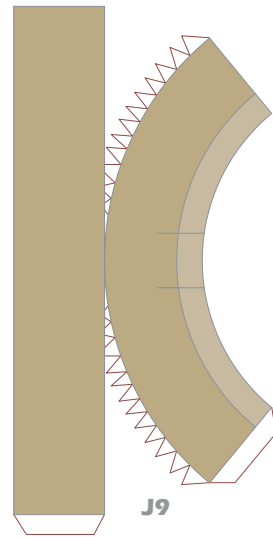

J9

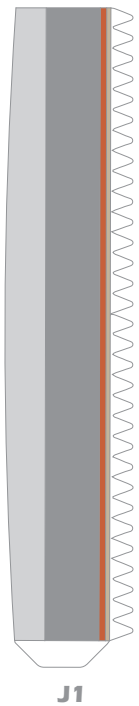

J1



J3

J4



J12

J13

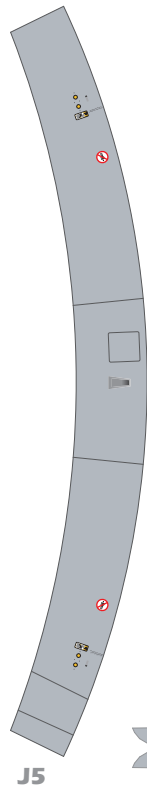

J5



J14

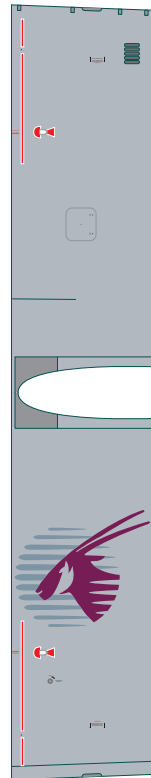

J6

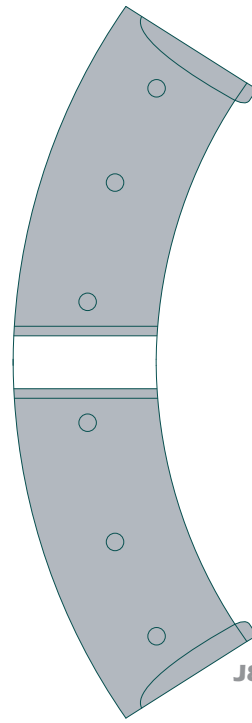

J8

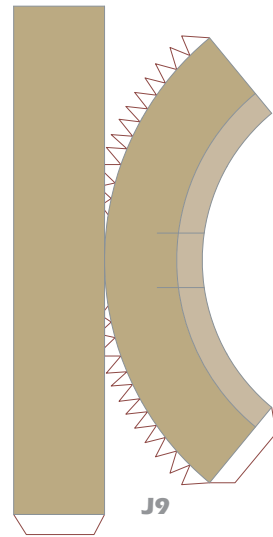

J9

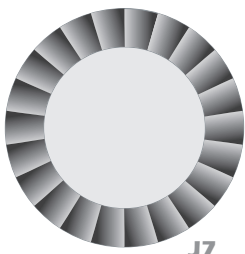

J7



J11



J10

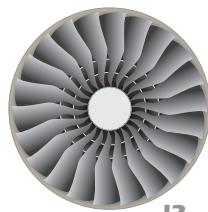

J2

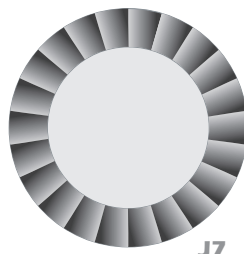

J7

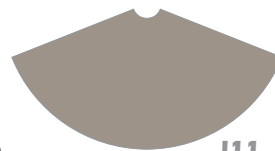

J11

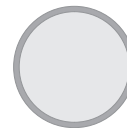

J10

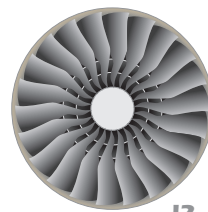

J2

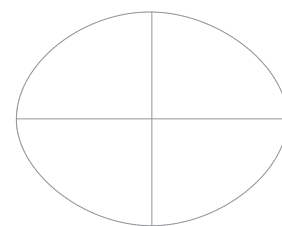
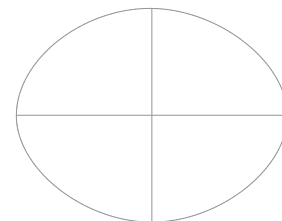
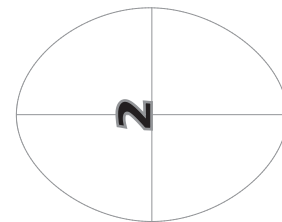
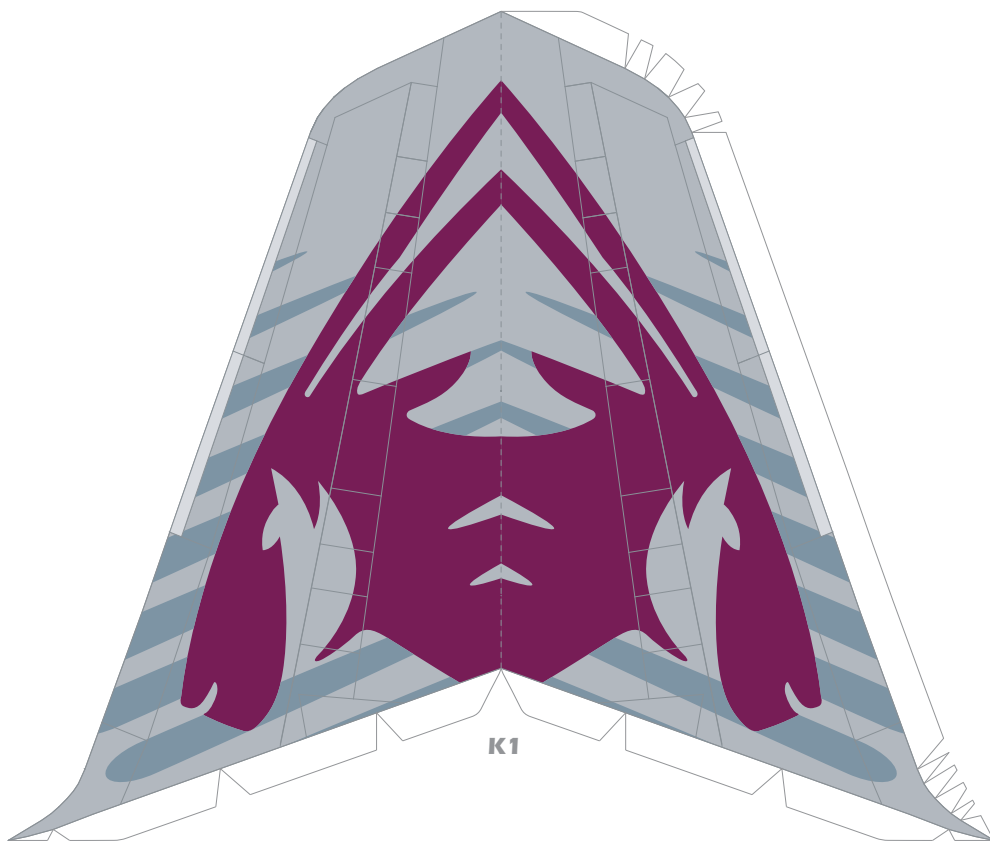

K2

K3

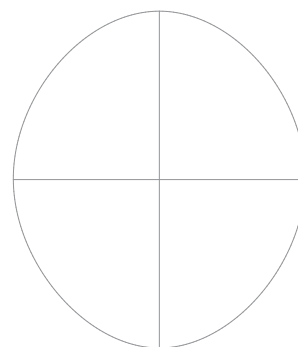
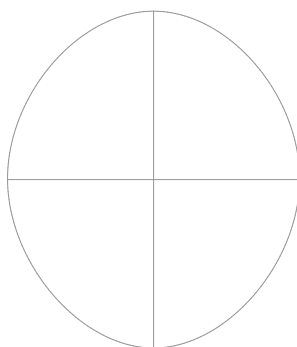
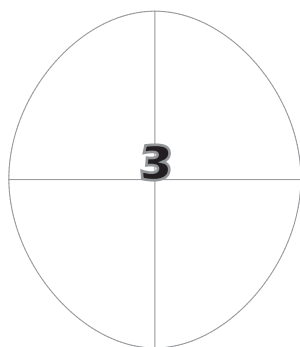

K4

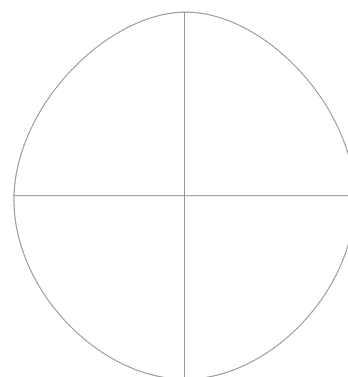
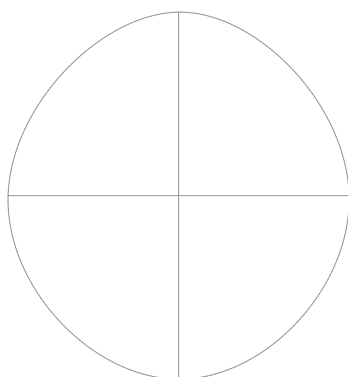
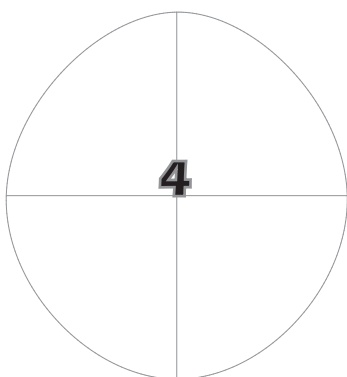

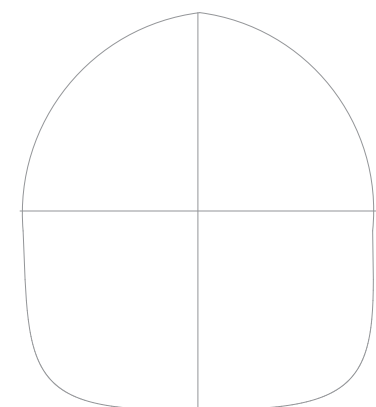
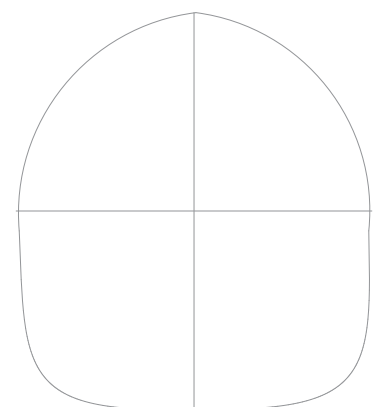
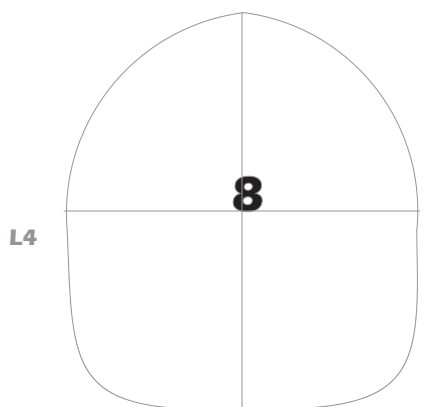
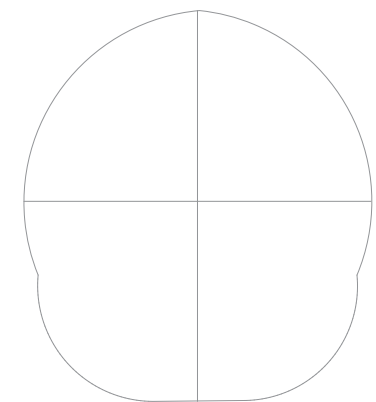
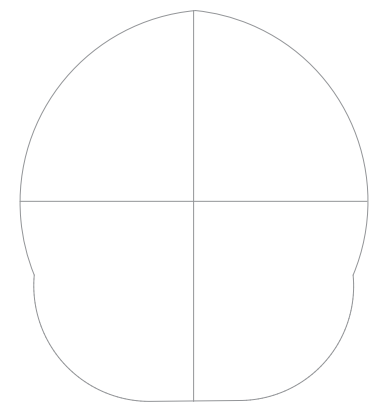
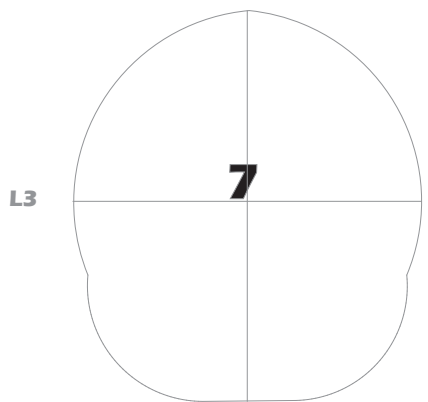
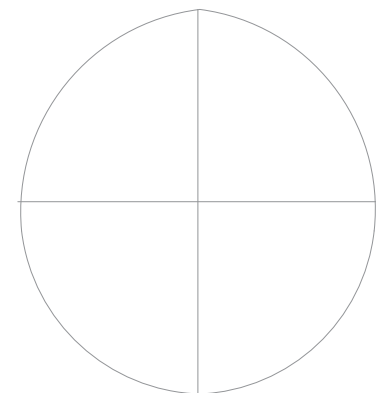
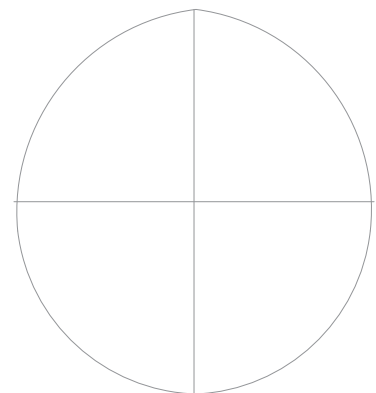
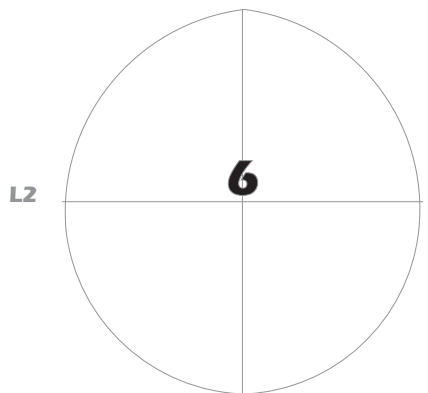
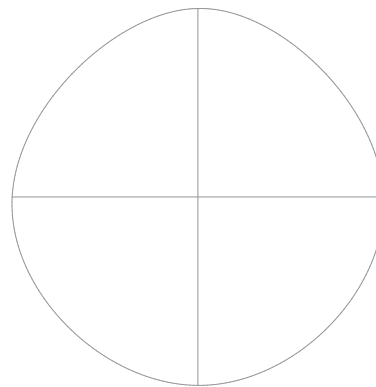
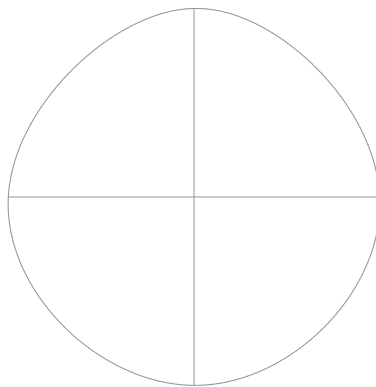
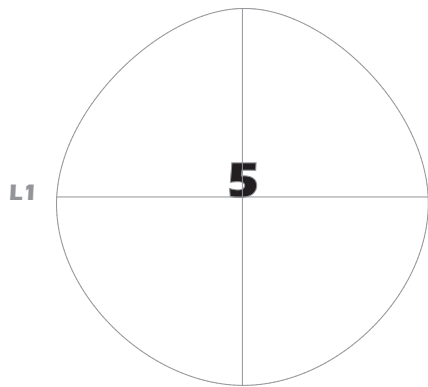

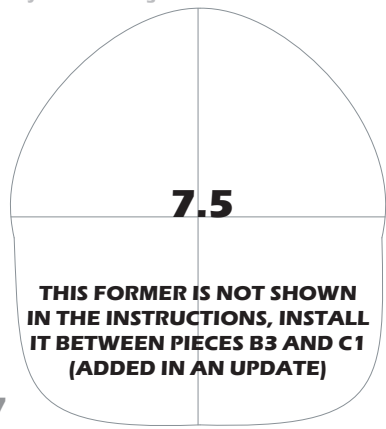

M7

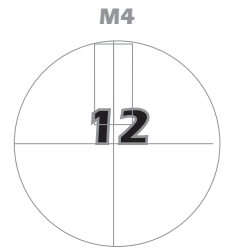
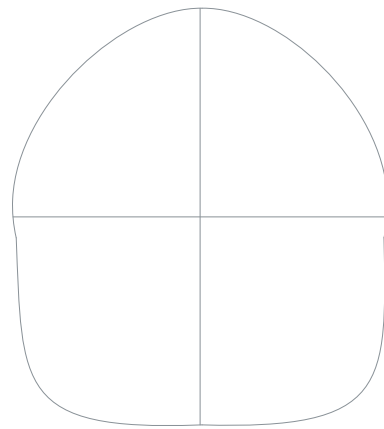
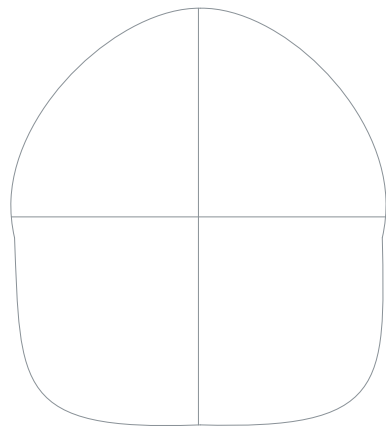

M4

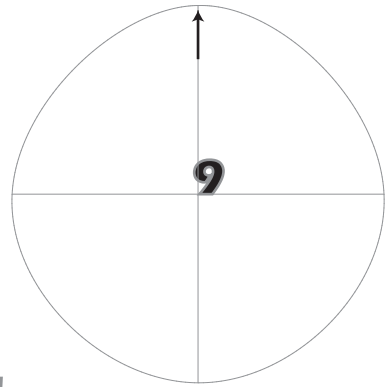
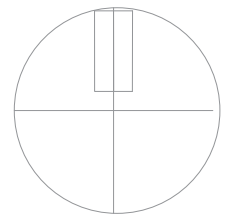
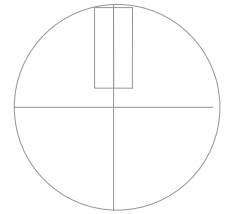

M1

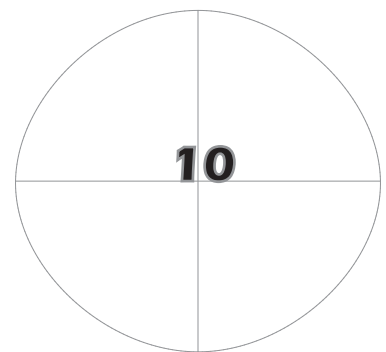
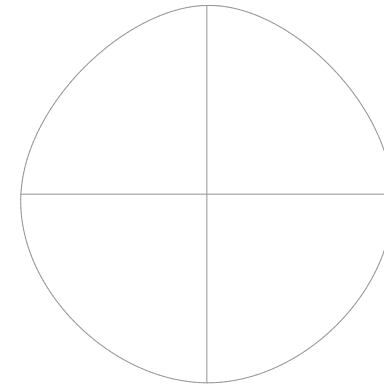
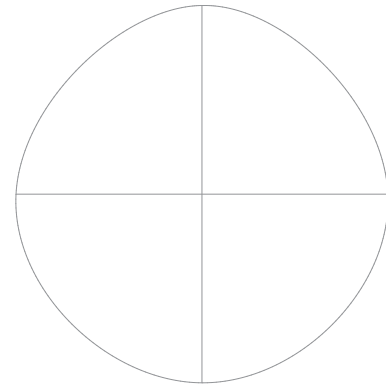

M2

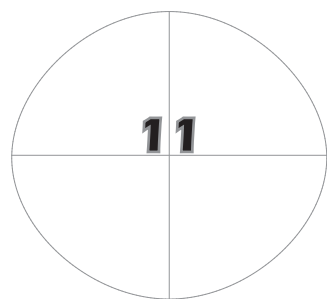
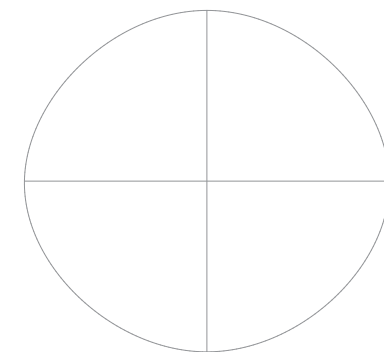
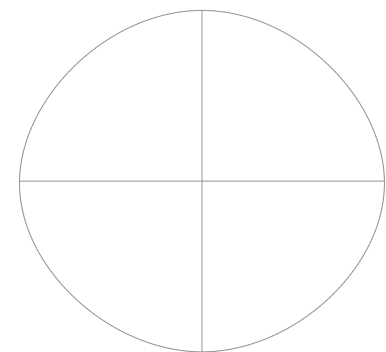

M3

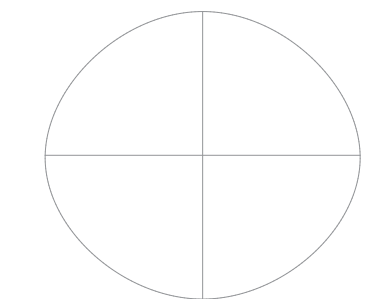
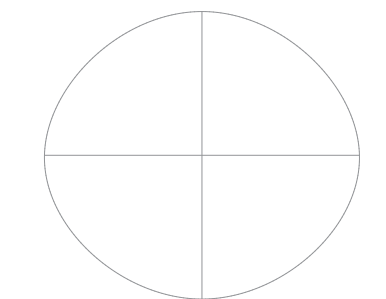

M5

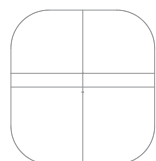
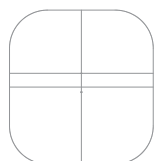

M6

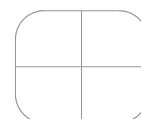
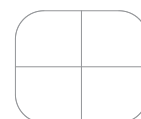

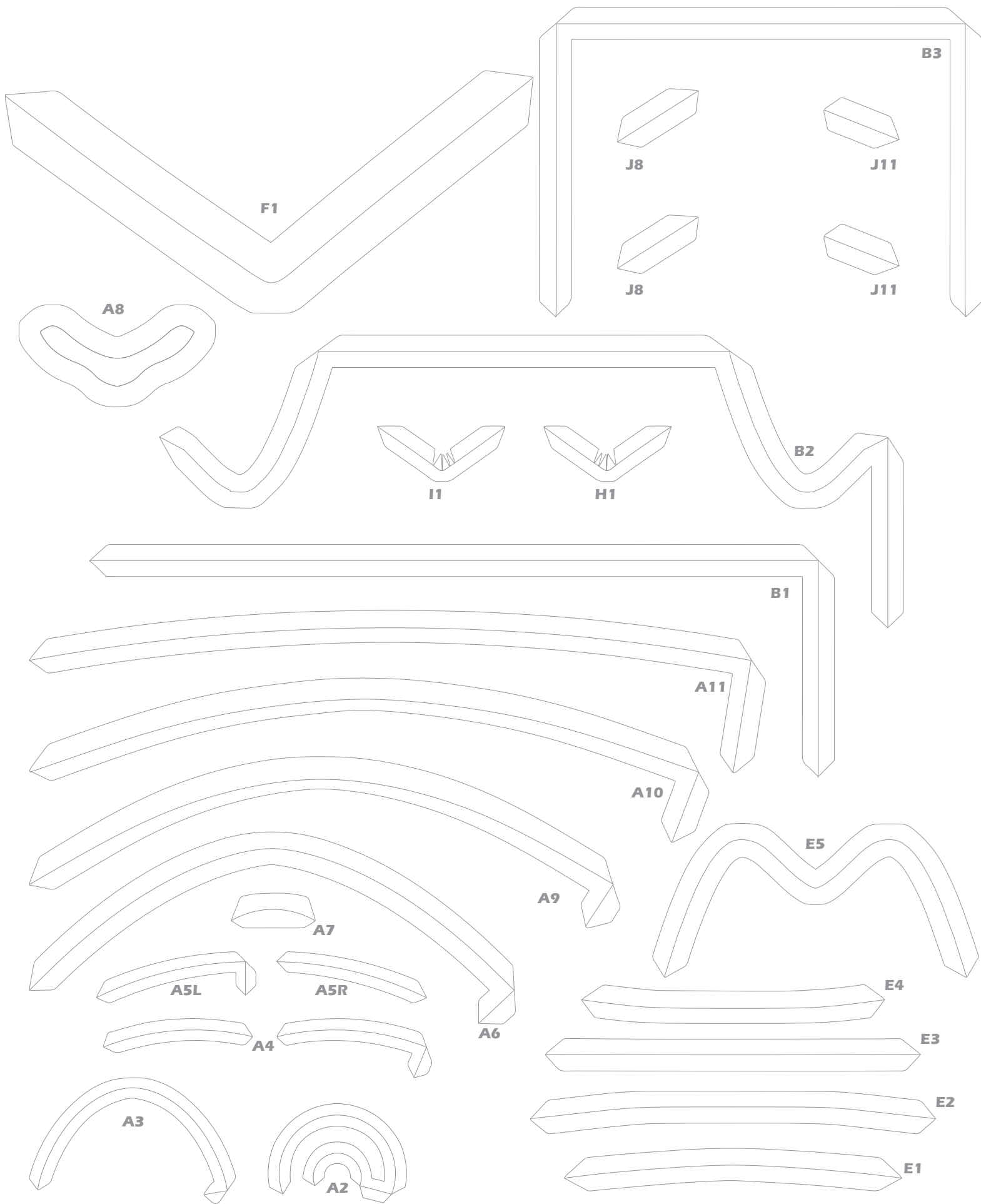

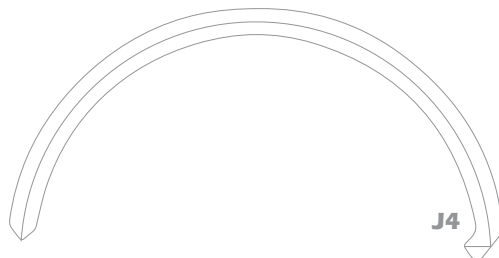
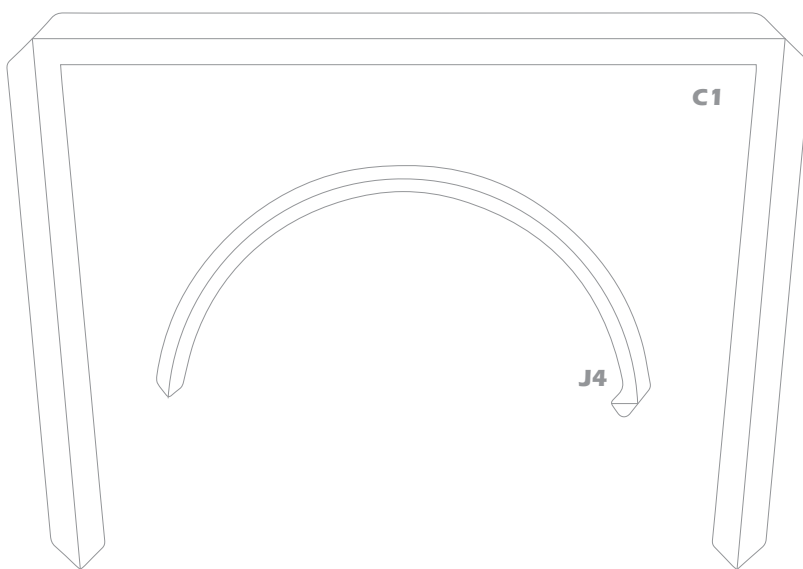
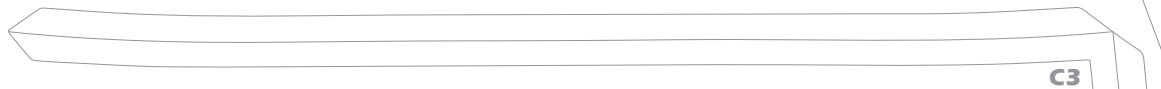
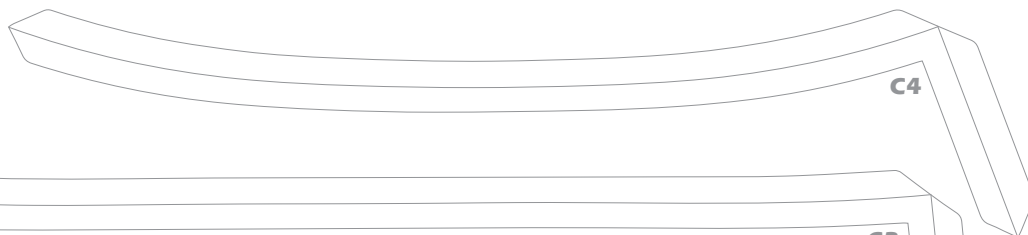
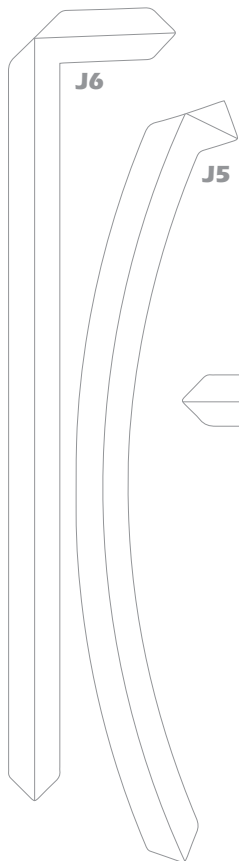
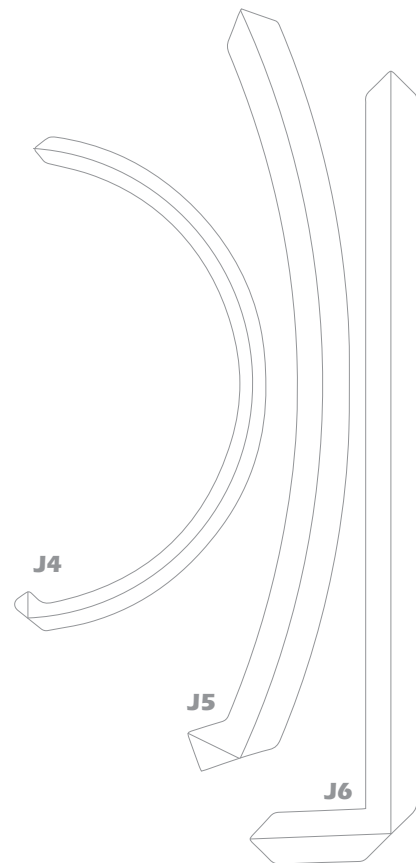
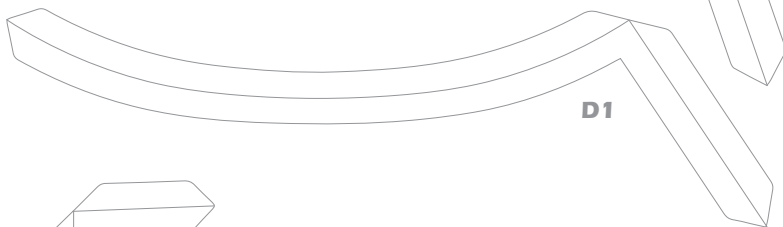
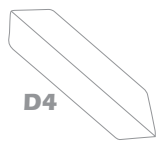
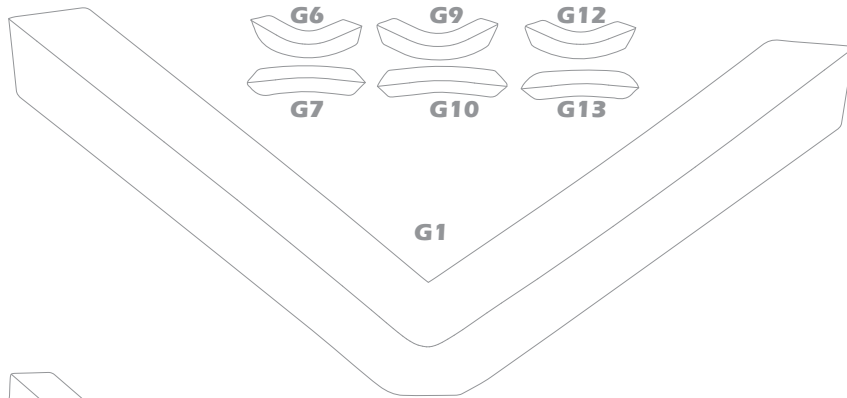
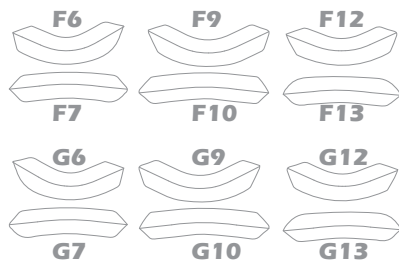

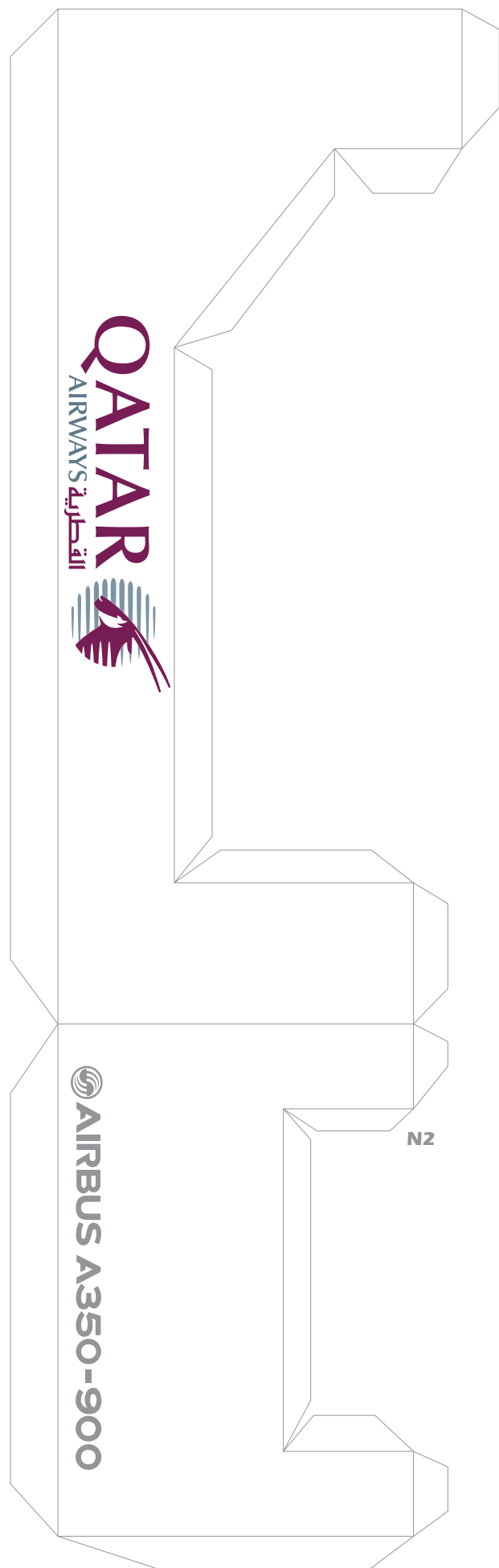
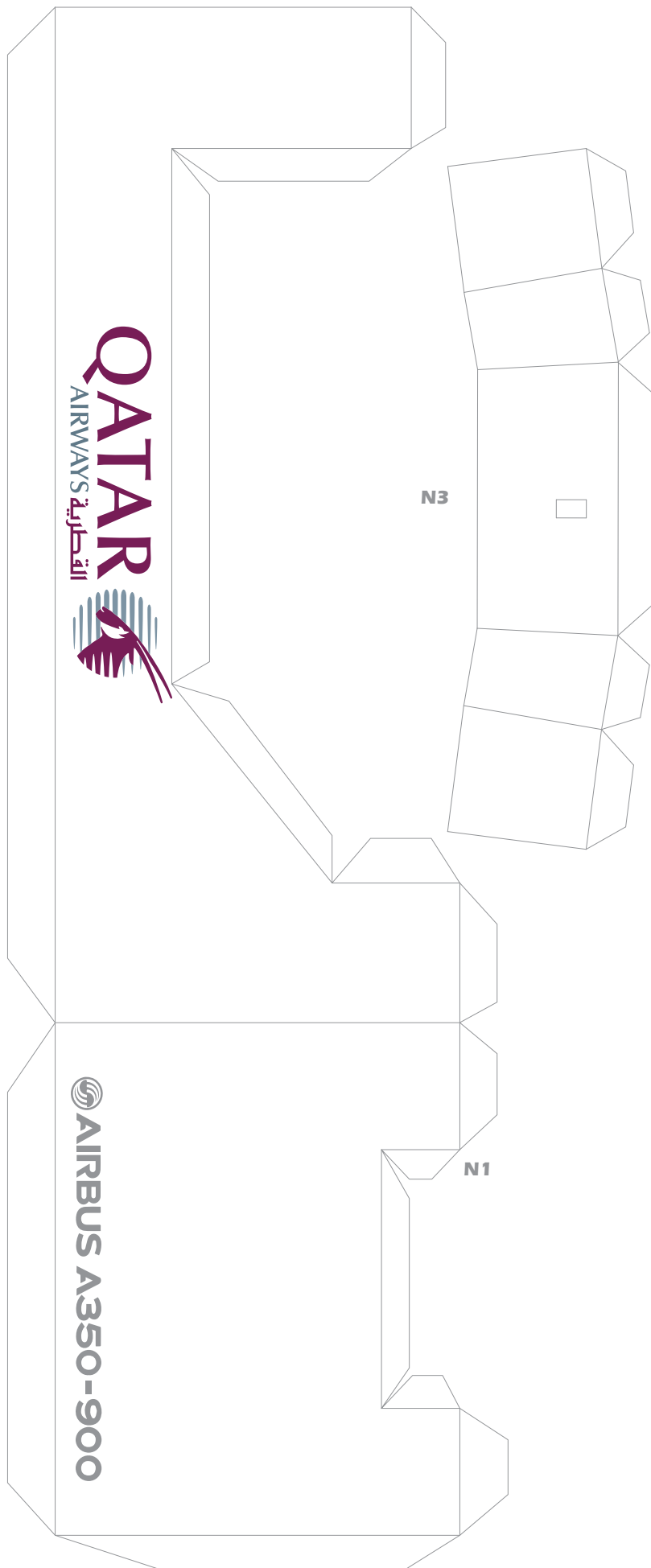



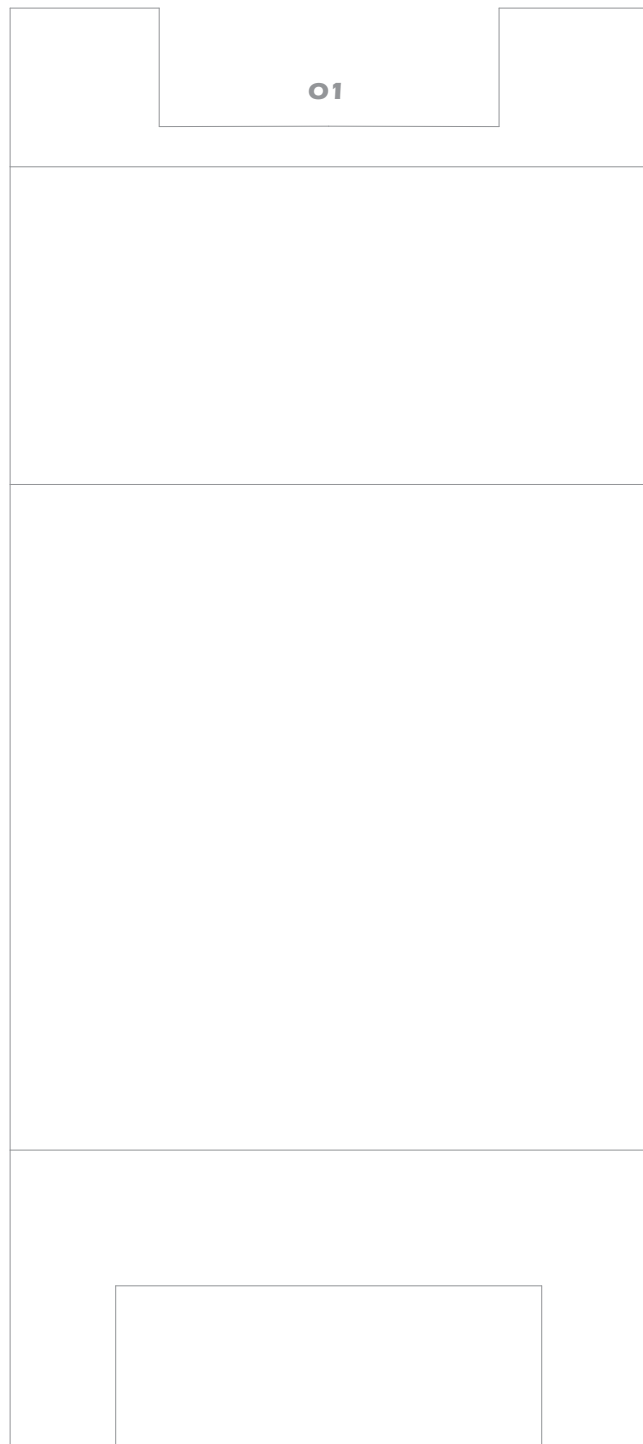

O3

ORIGINAL MODEL DESIGNED BY EDWIN RODRIGUEZ

HERMERCRAFT

PLEASE DO NOT SELL THIS FILE | DESIGNED IN PALMARES, COSTA RICA