

- B5\* 
- B7\* 
- B9\* 
- B6\* 
- B8\* 
- B10\* 

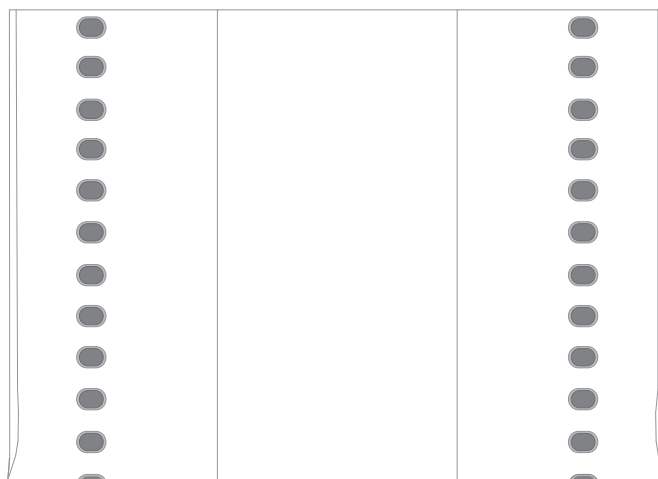

B3

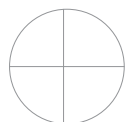
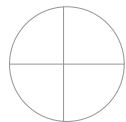
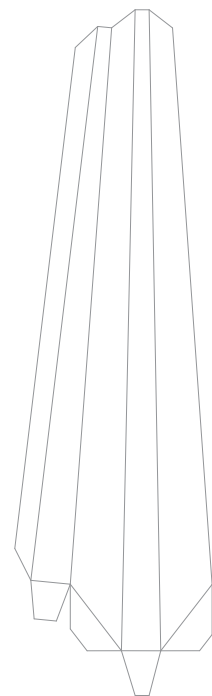

B13

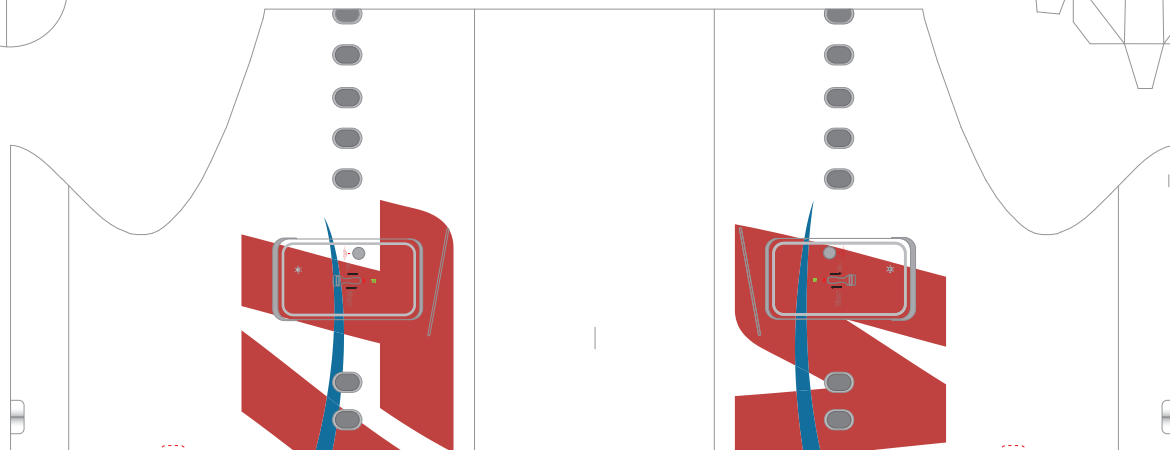

B2



B1

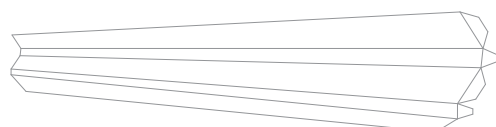

B12R



B11



B12L

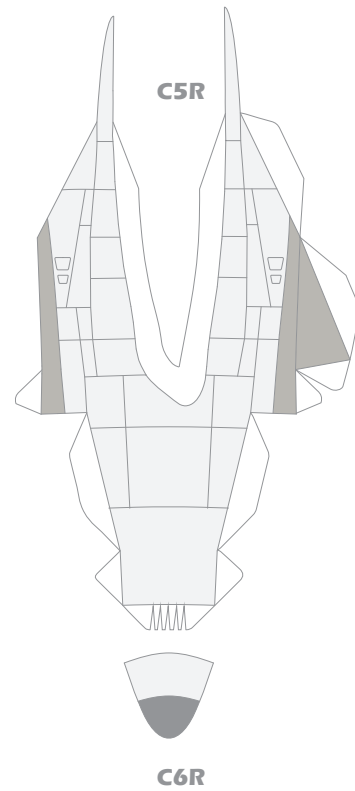
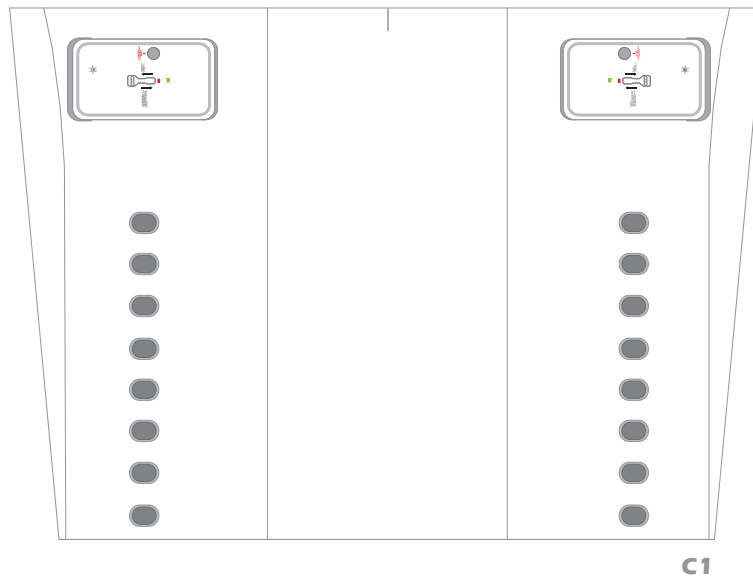
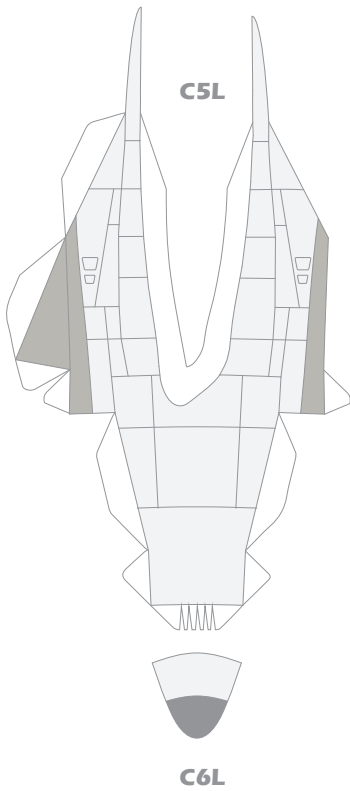
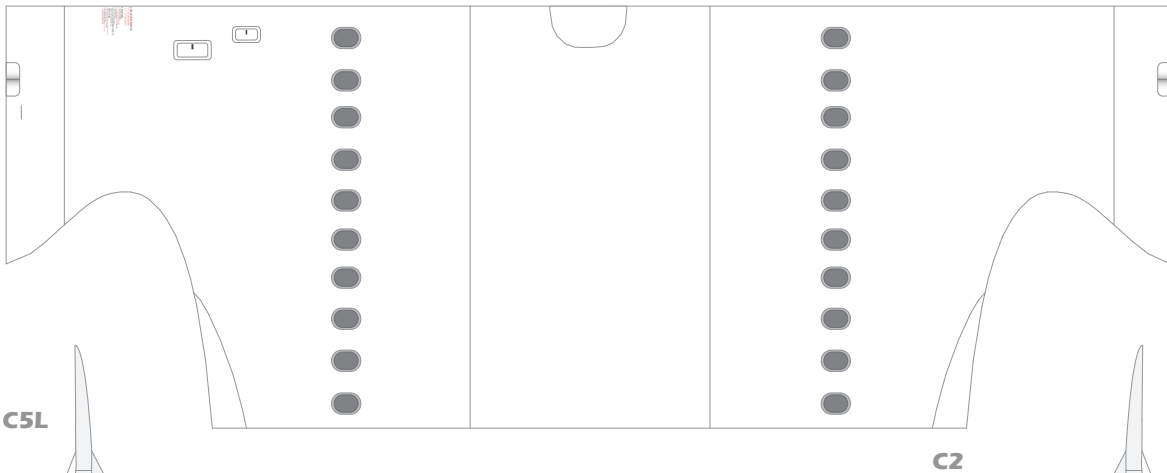
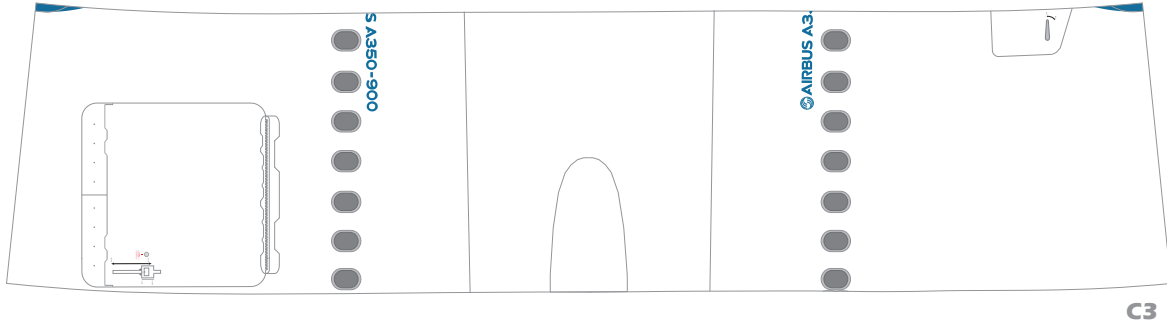
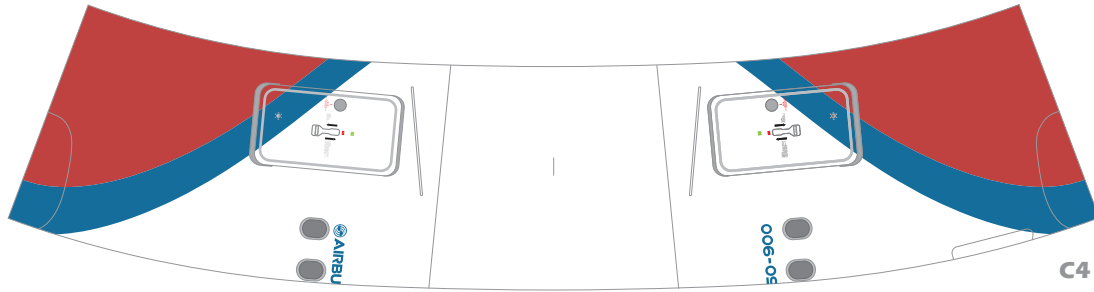

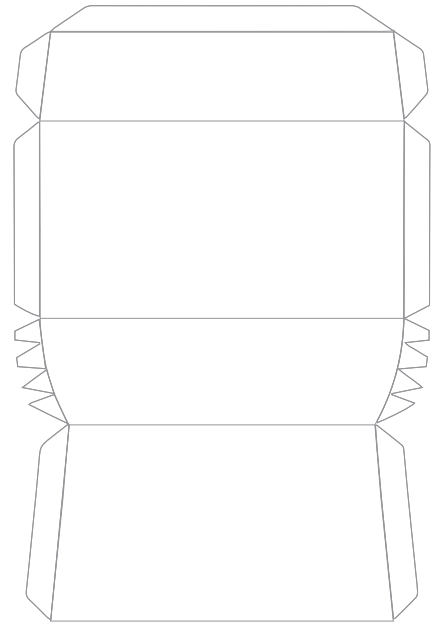
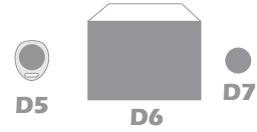
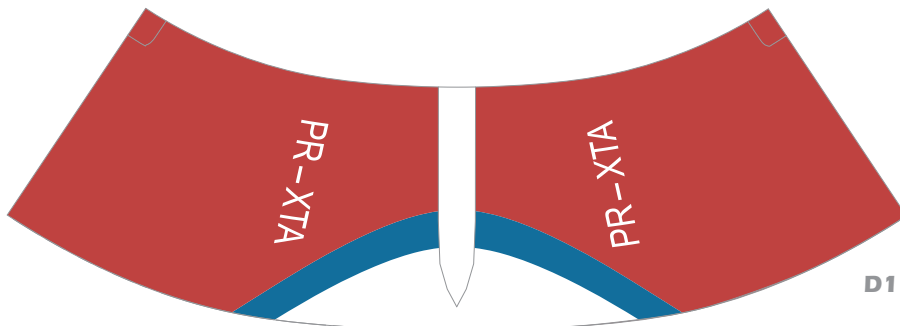
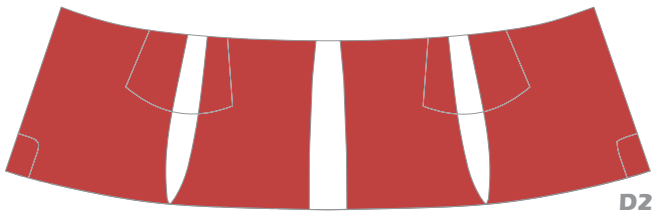
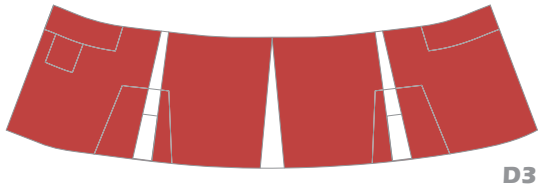
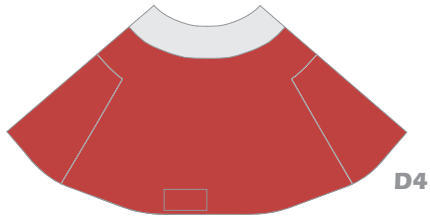
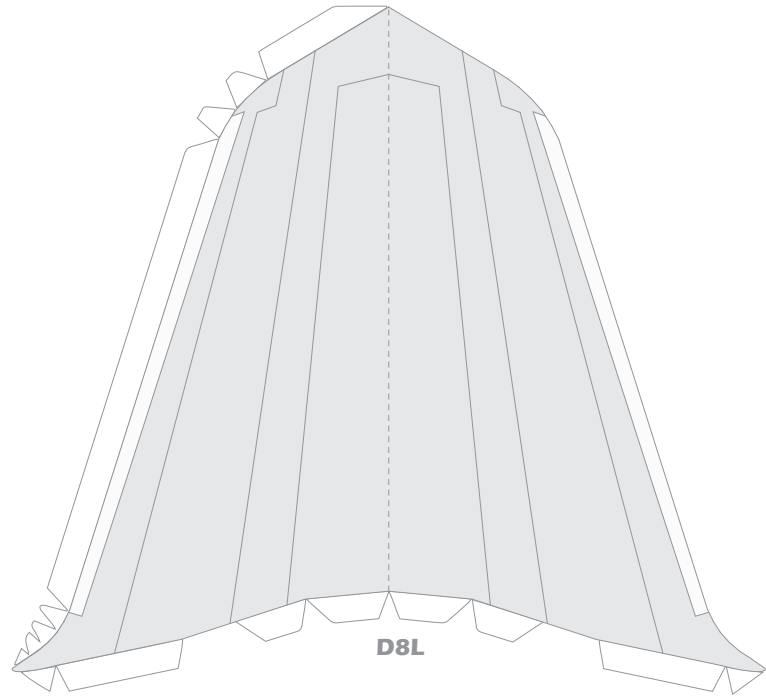
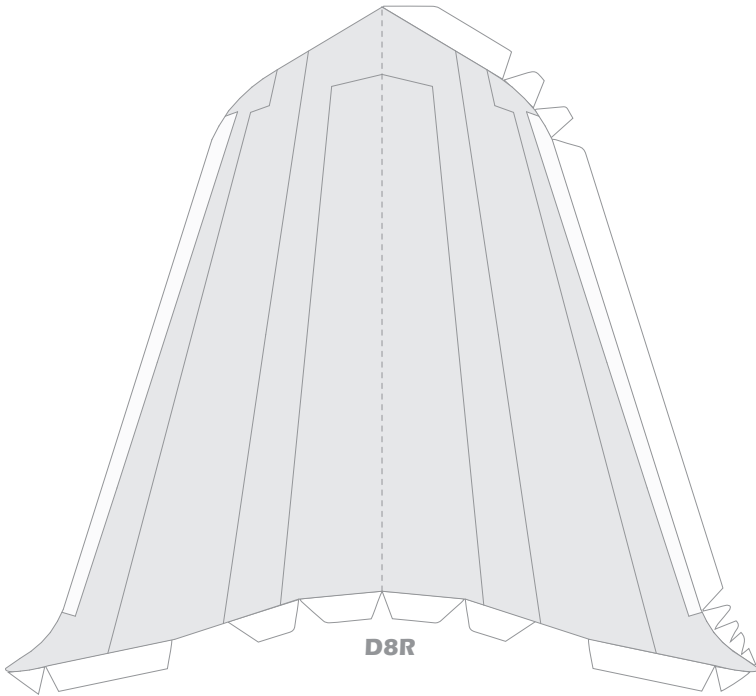

D9

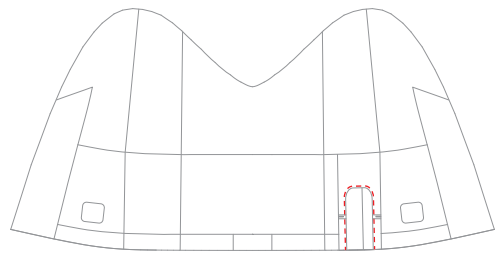
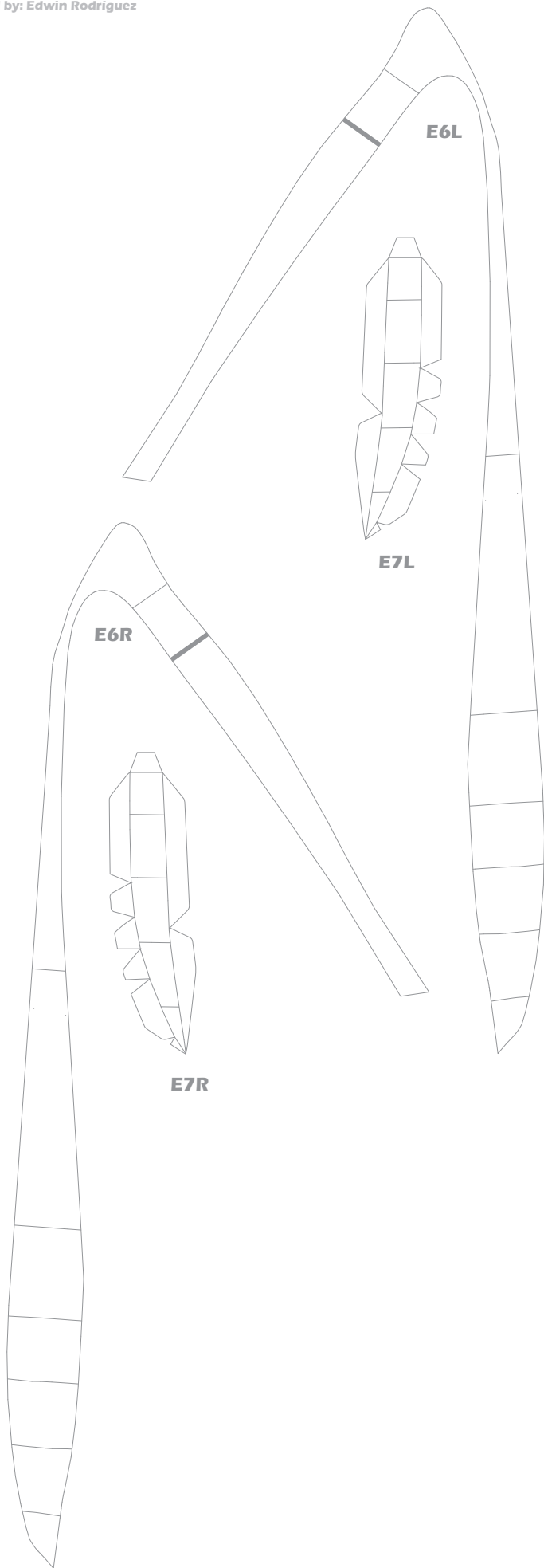

E5



E4

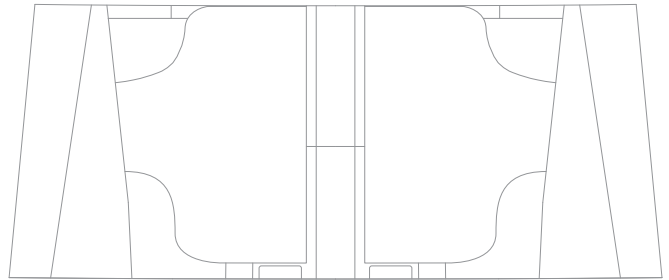

E3

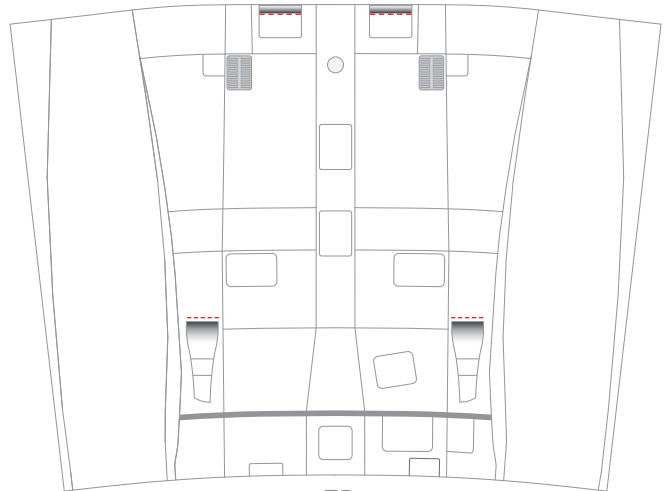

E2

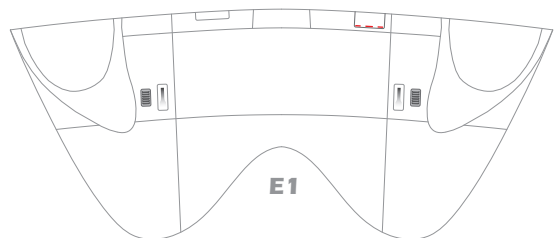

E1

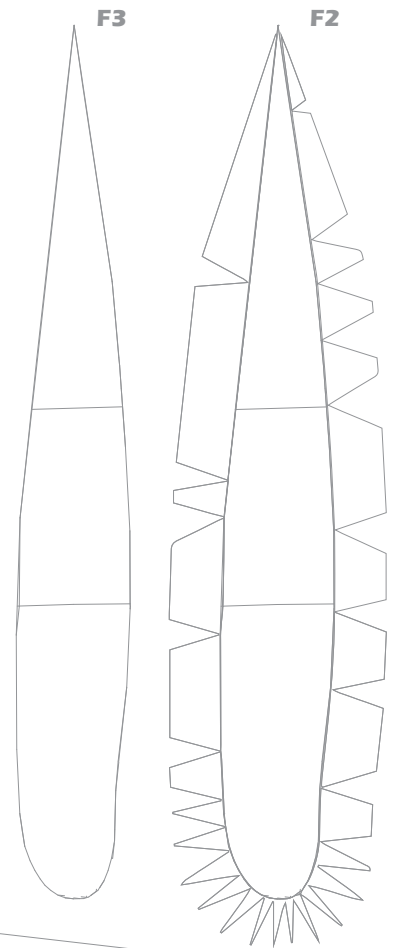
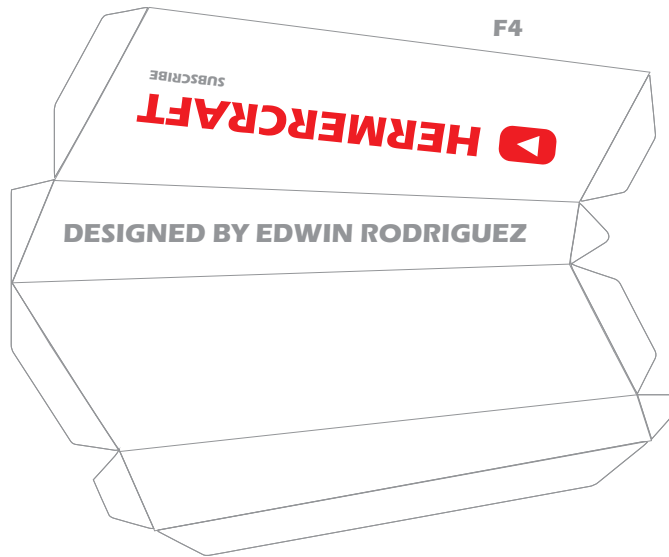
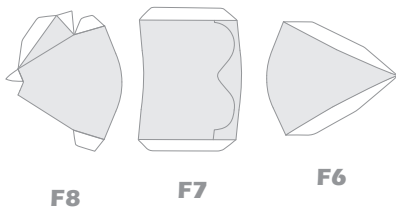
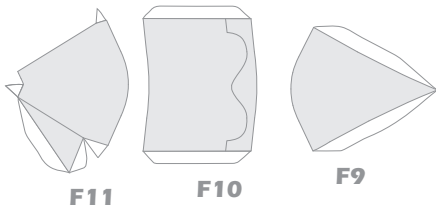
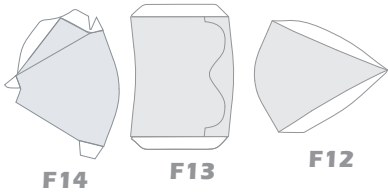
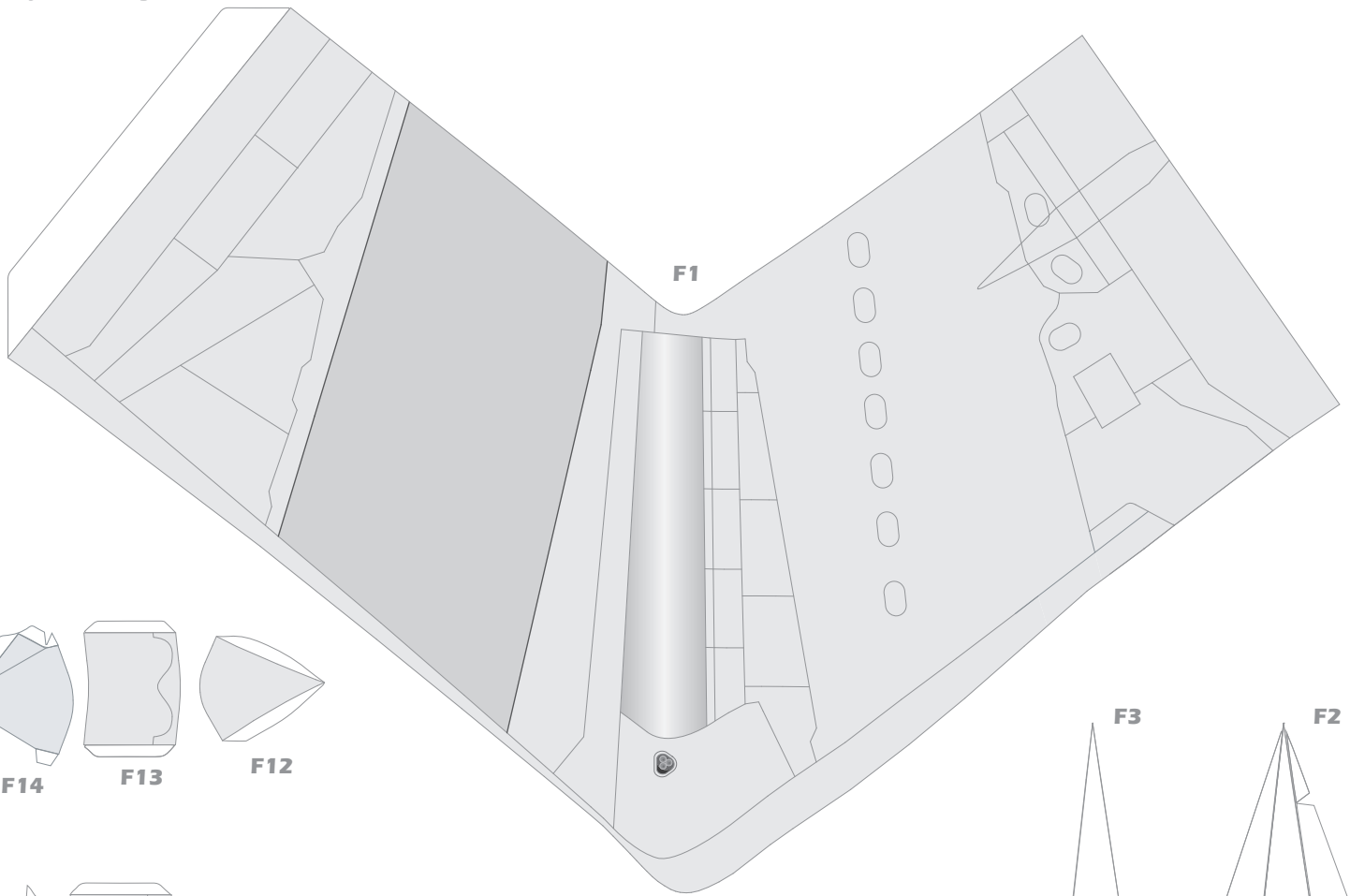

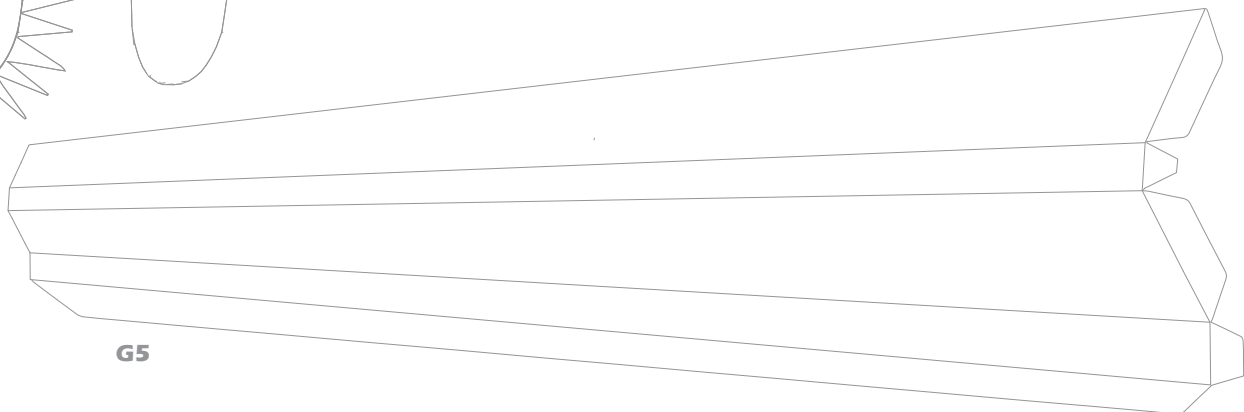
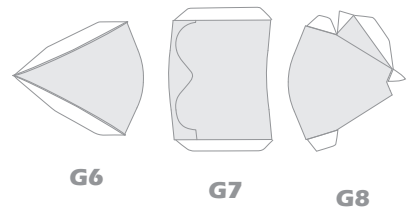
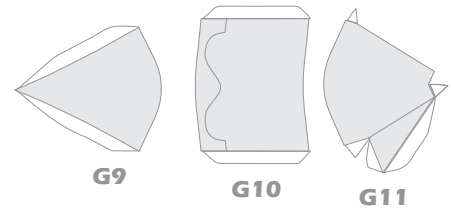
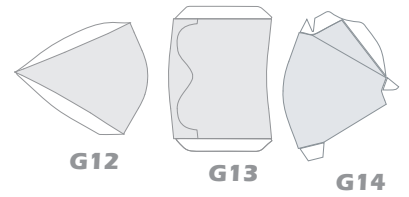
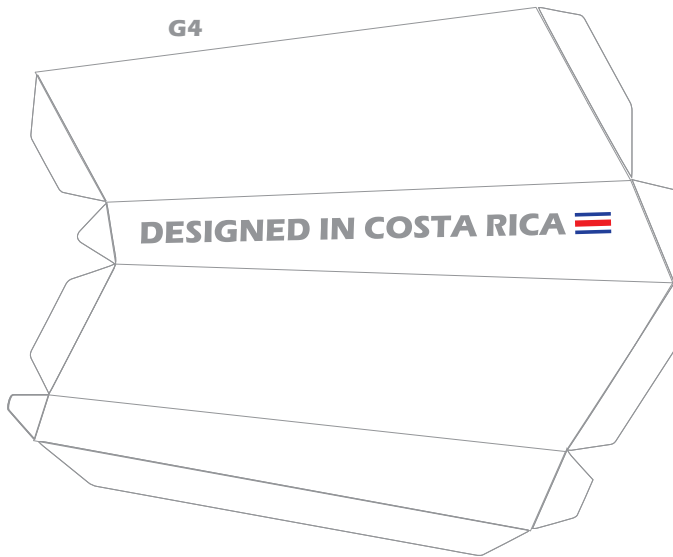
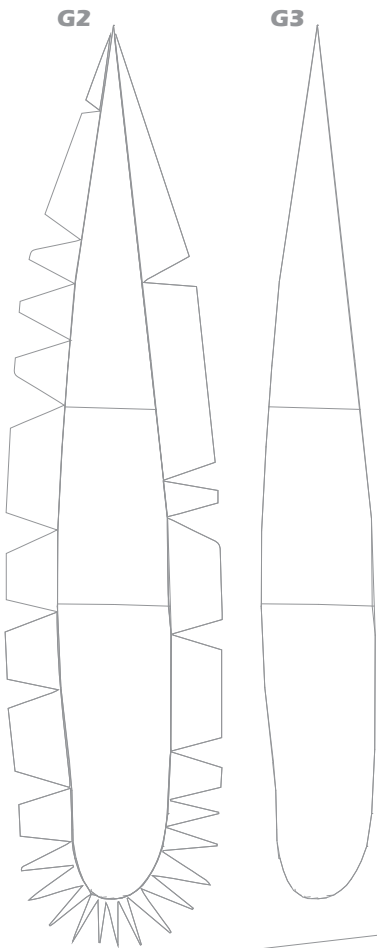
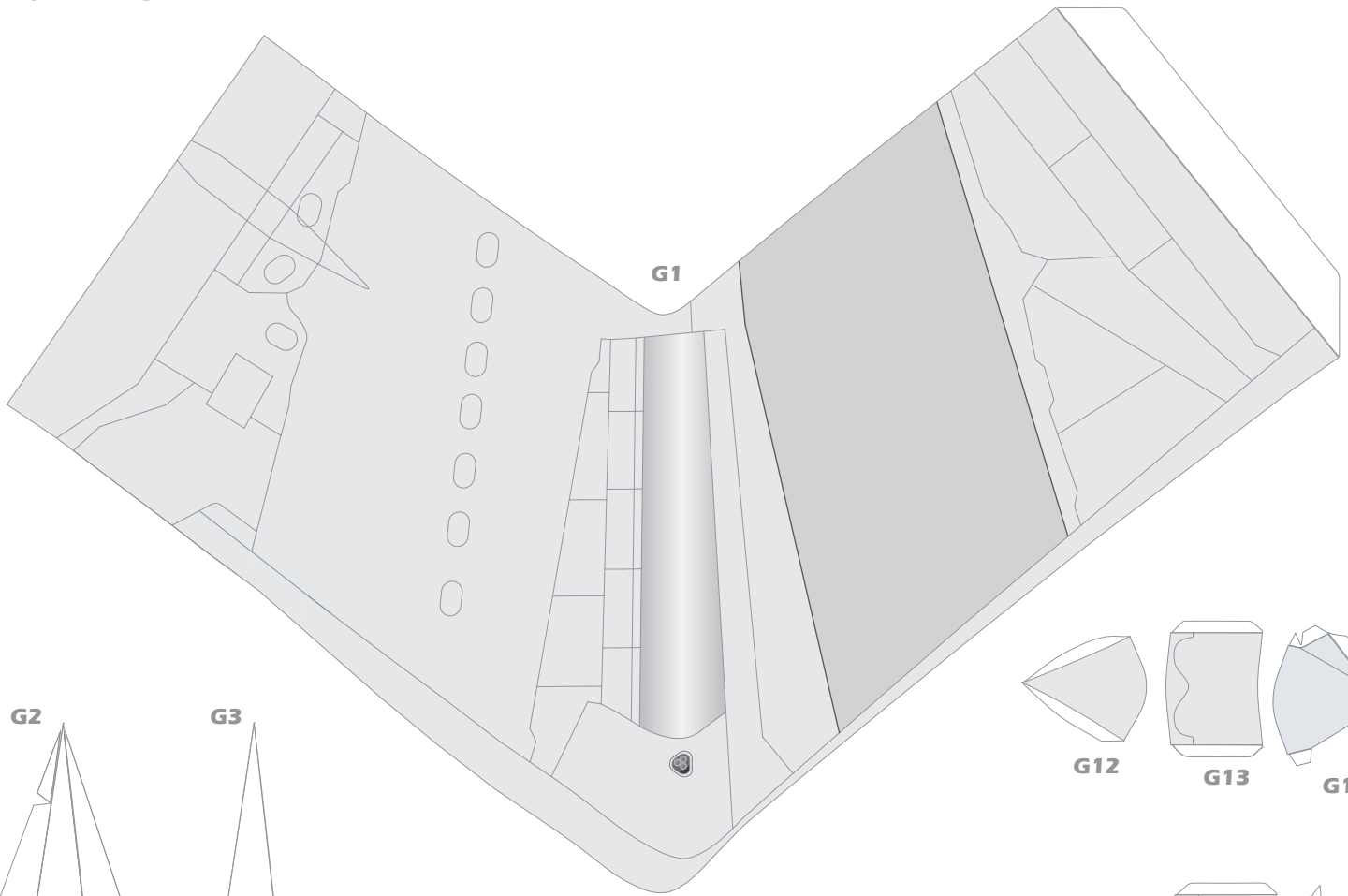

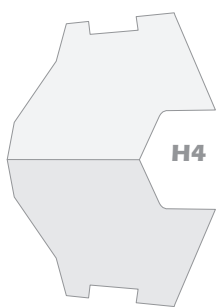
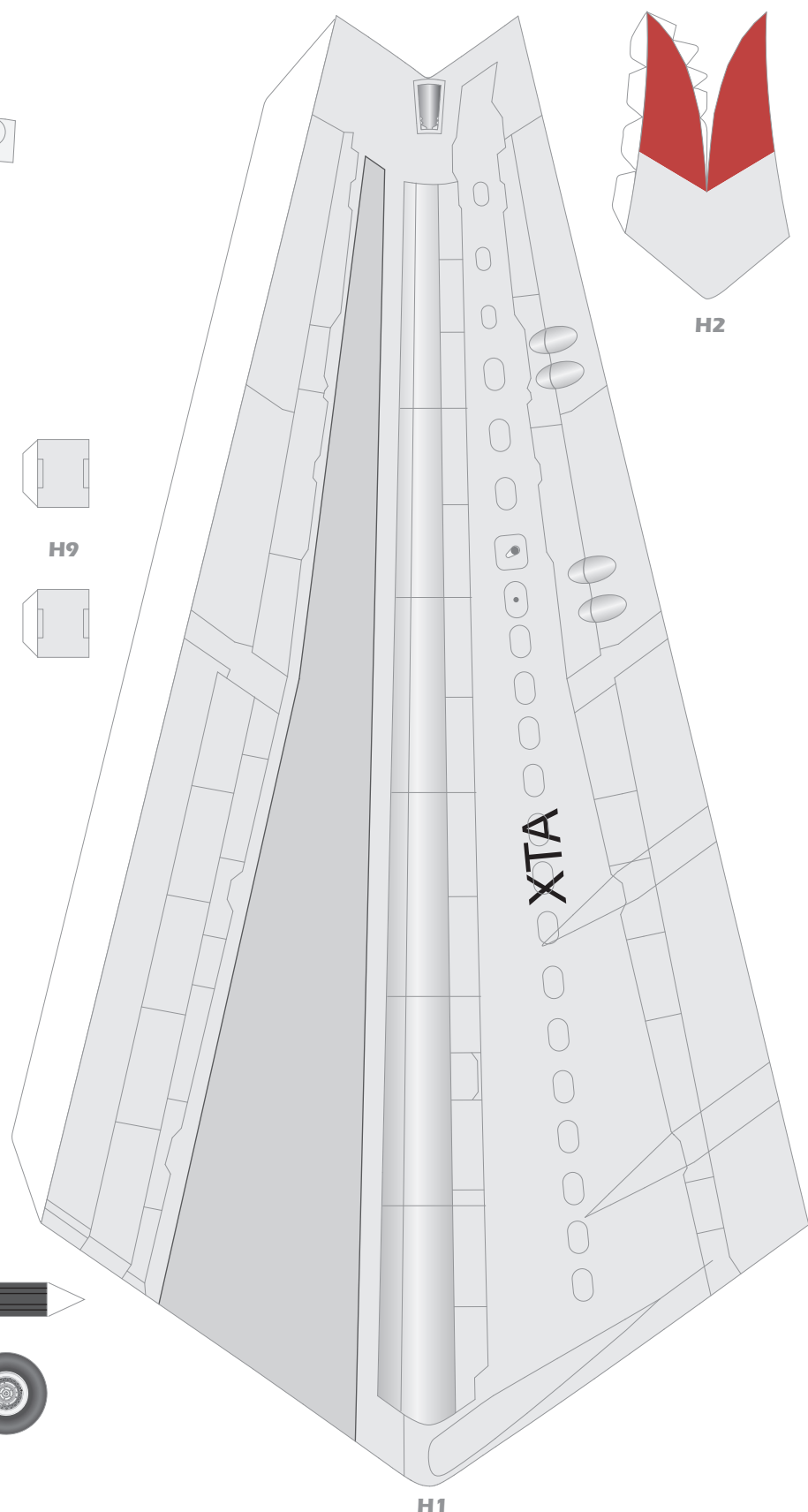

H4

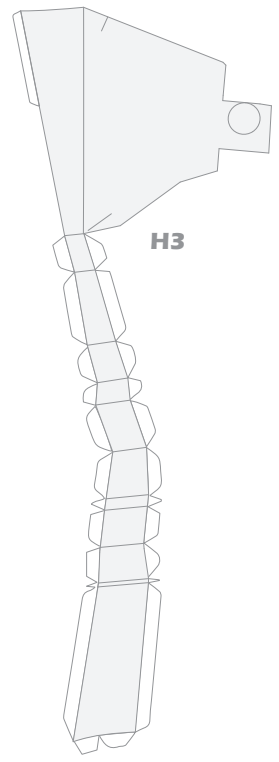

H3

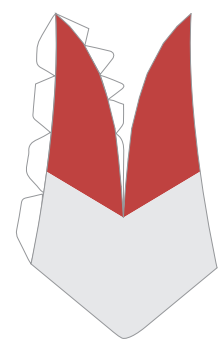

H2



H5



H9

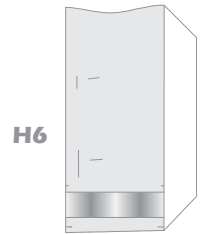

H6



H8

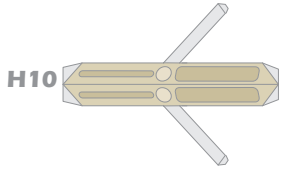

H10

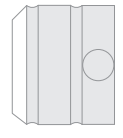

H7



H11



H12

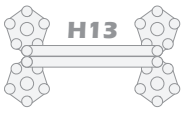

H13

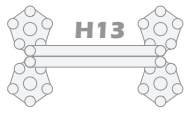

H13



H14



H15



H14



H15



H1



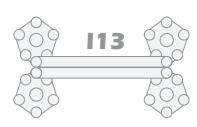
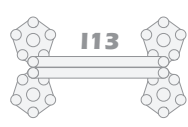
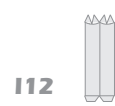
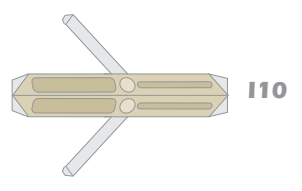
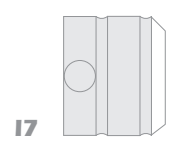
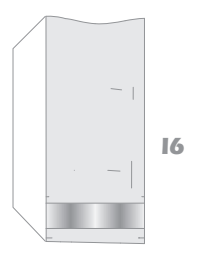
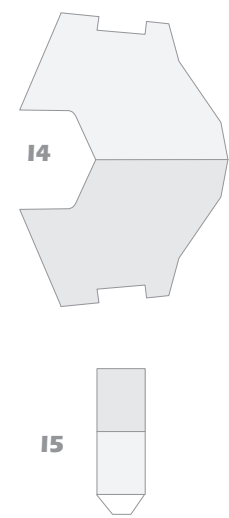
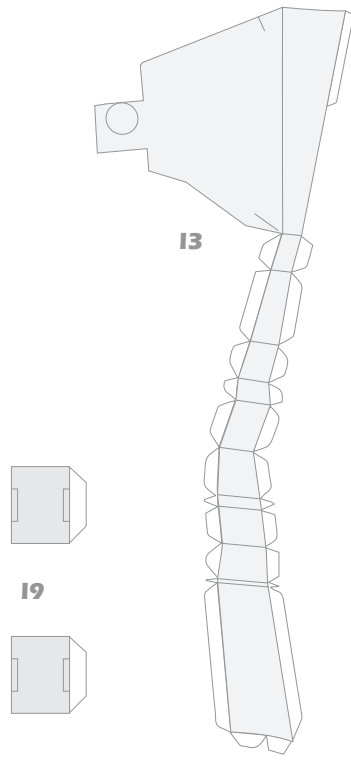
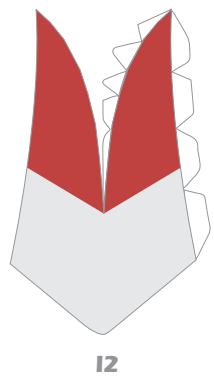
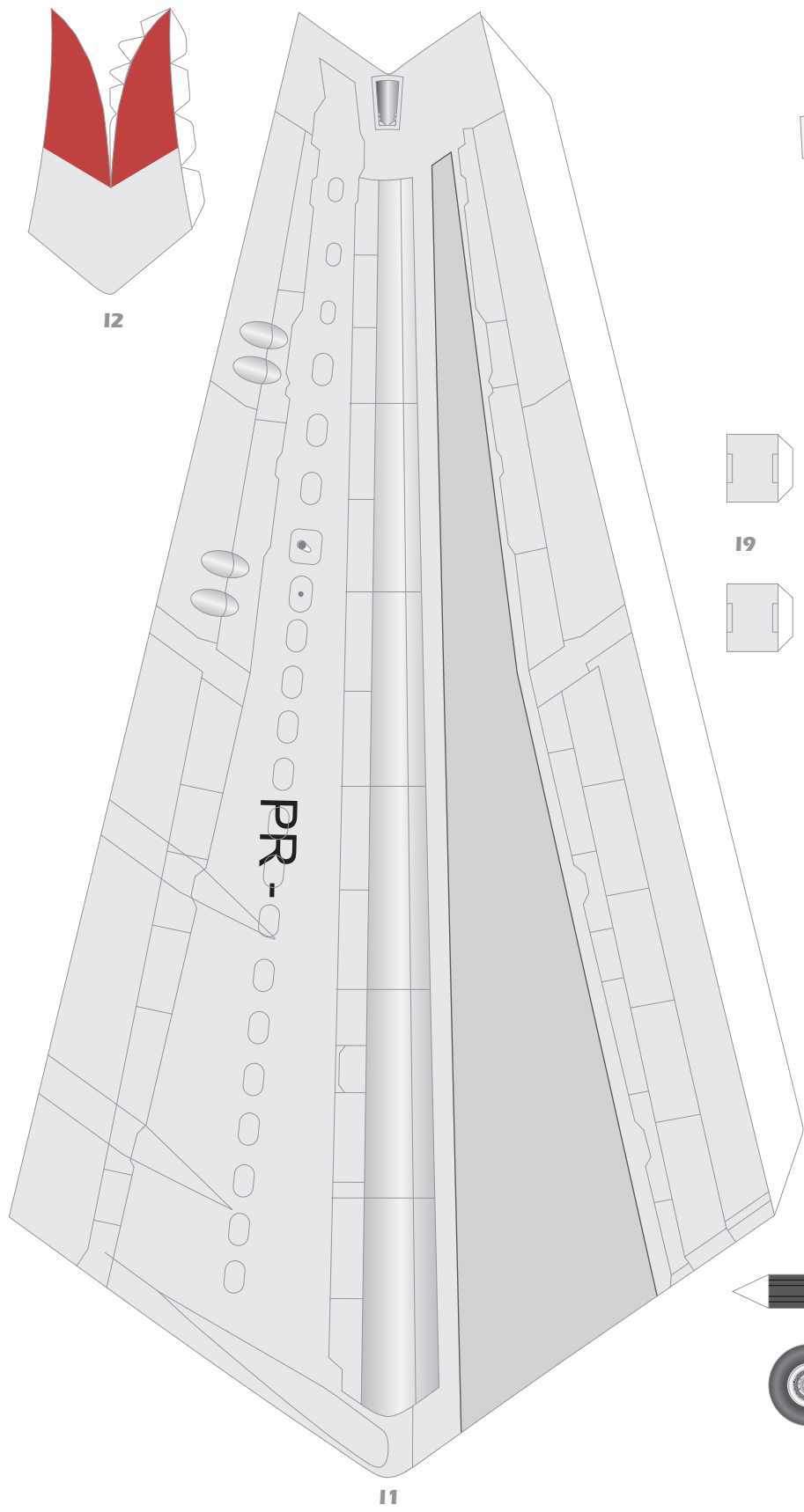

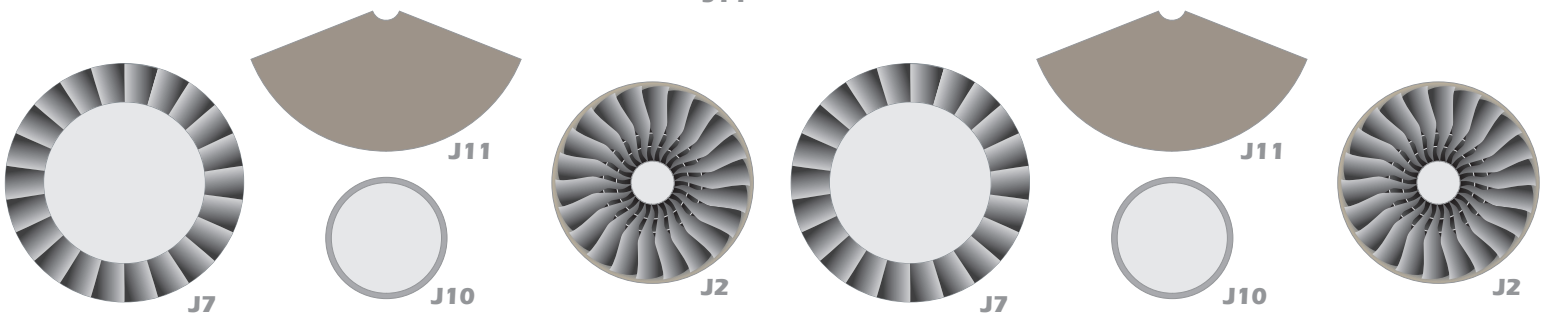
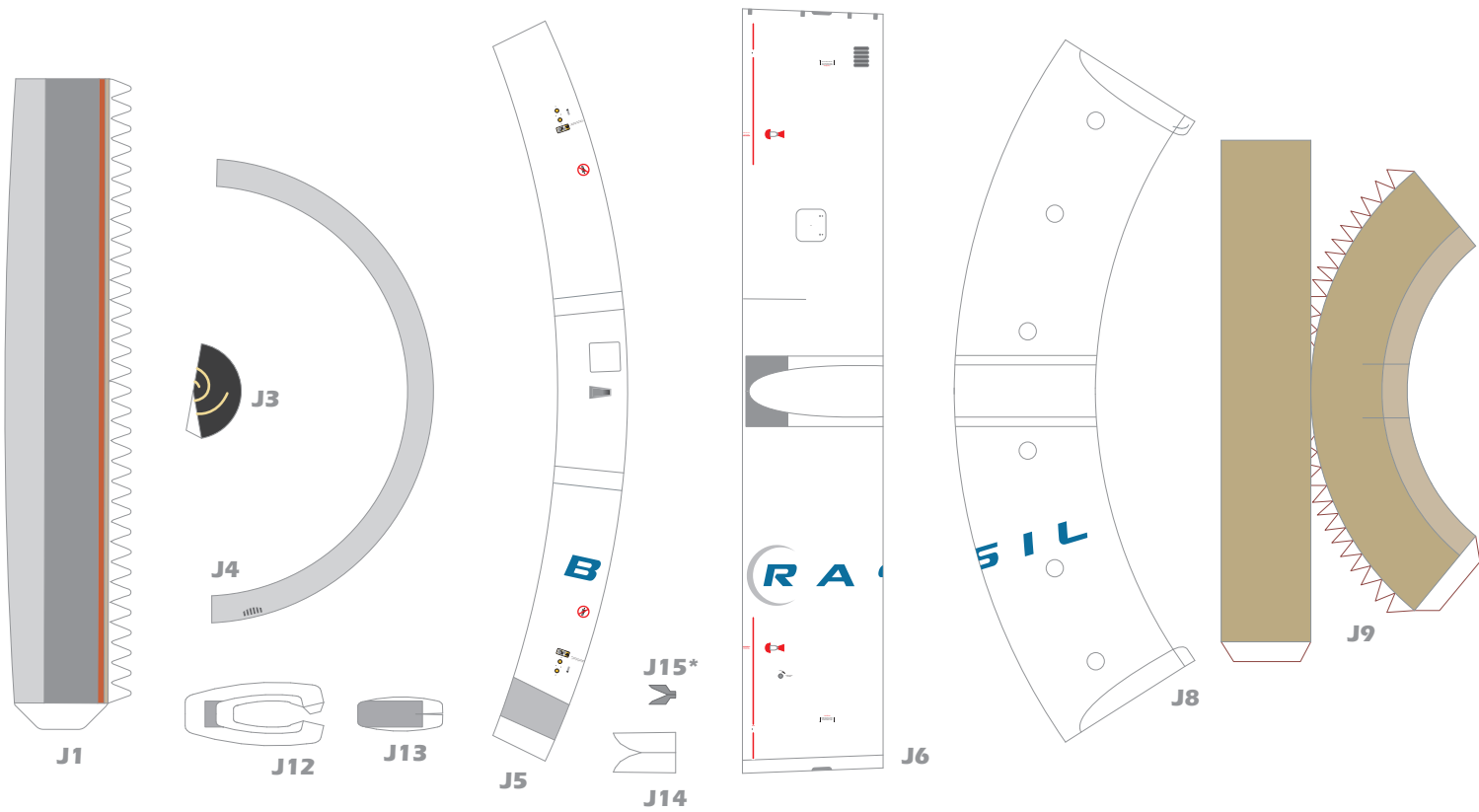
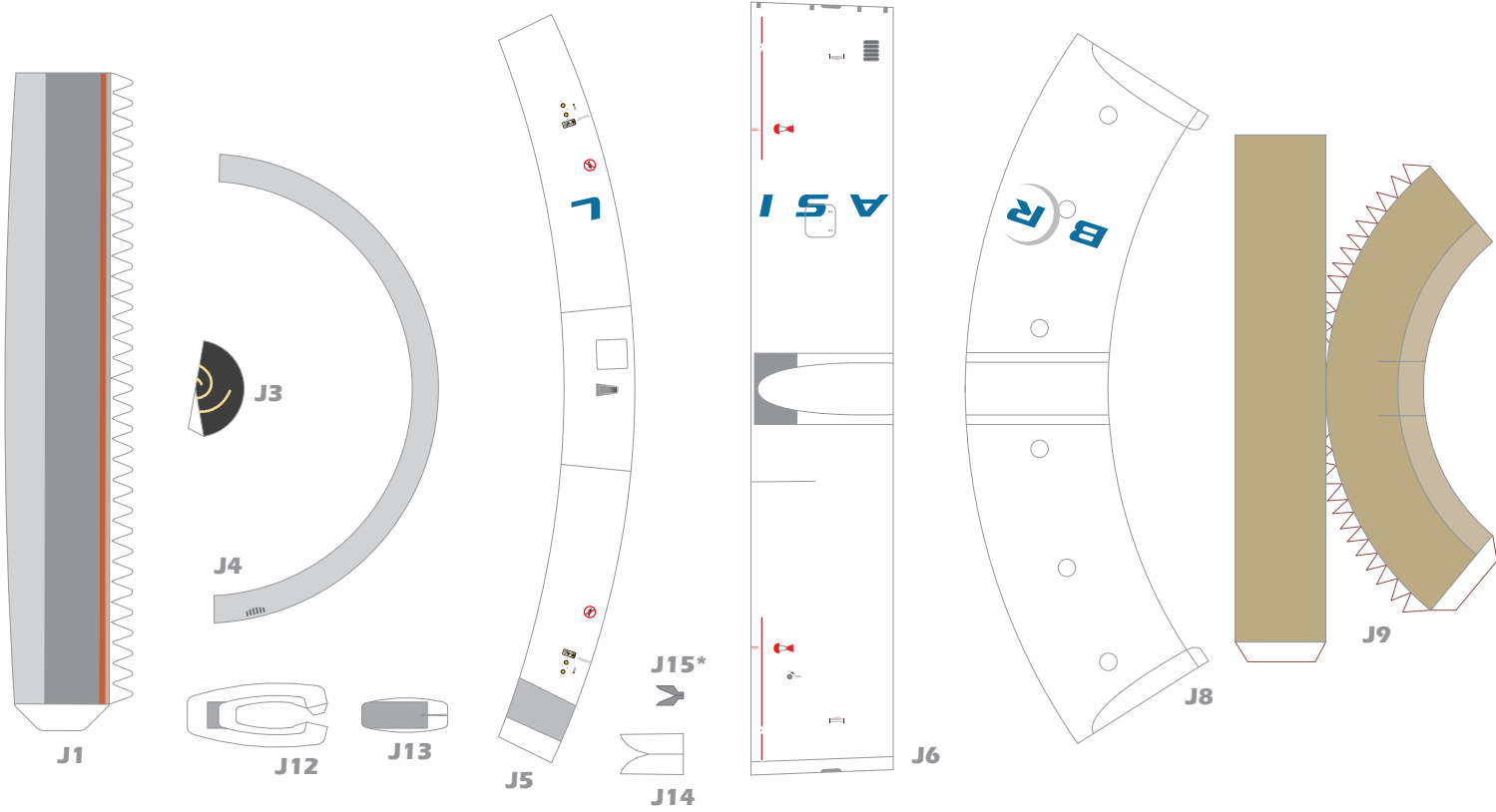

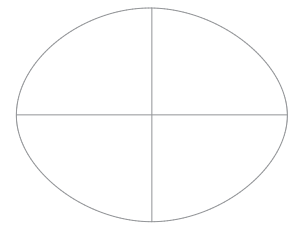
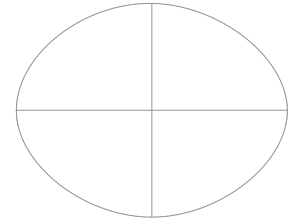
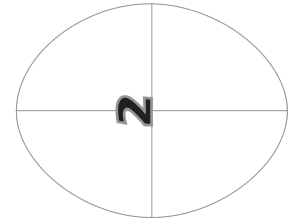
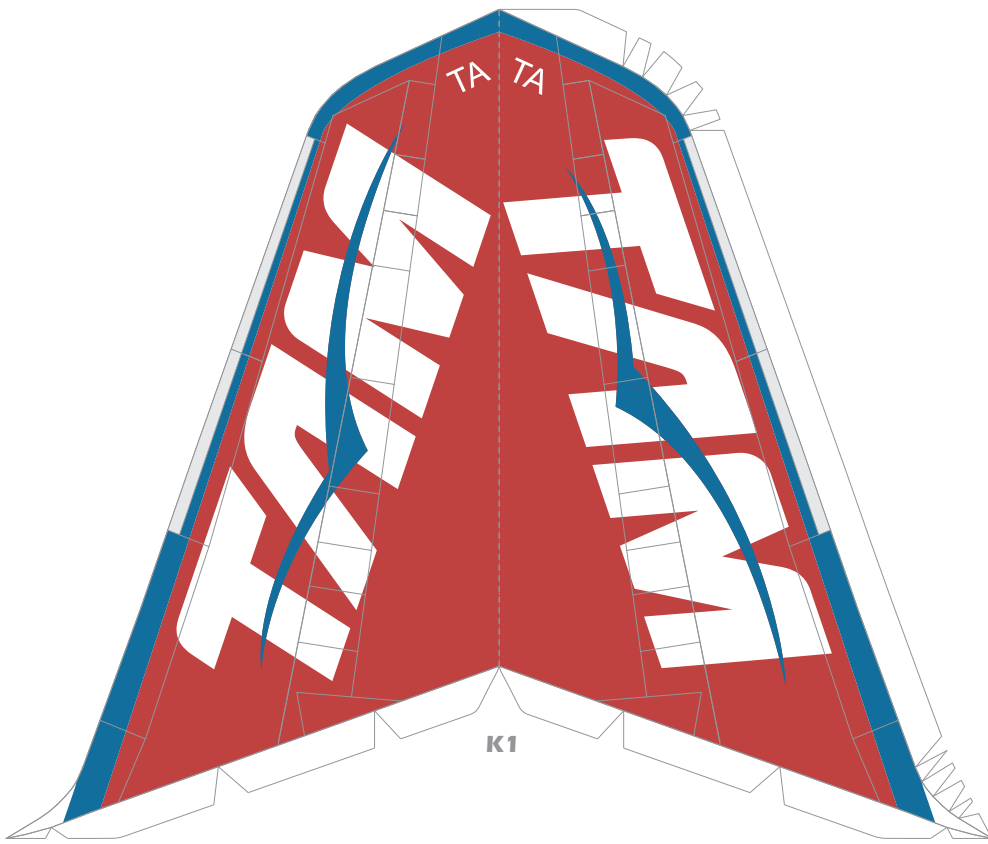

K2

K3

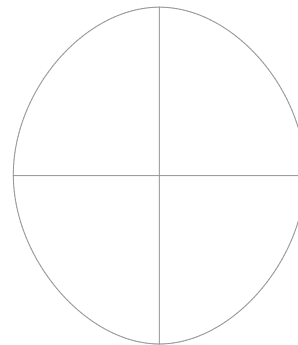
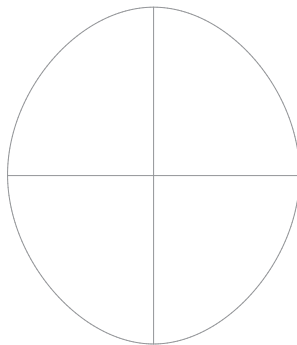
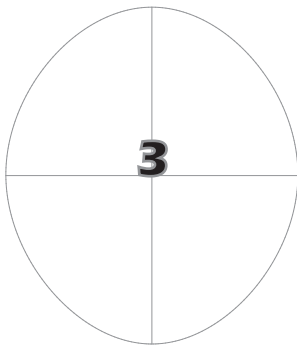

K4

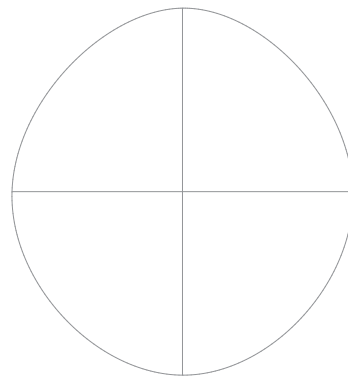
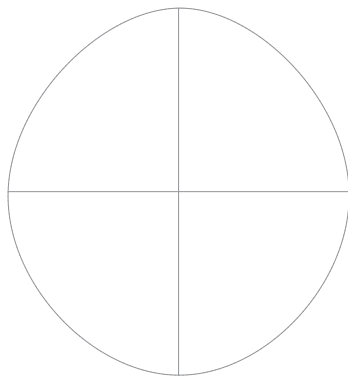
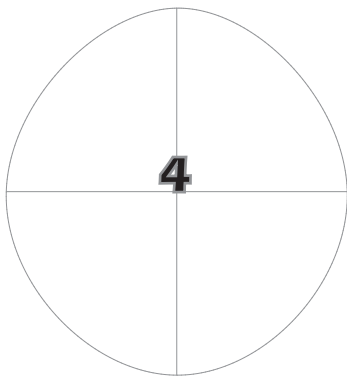

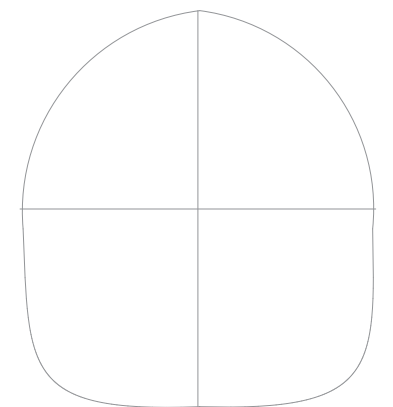
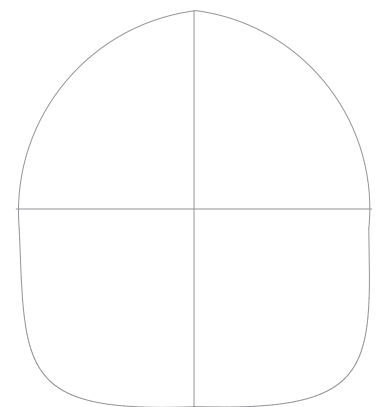
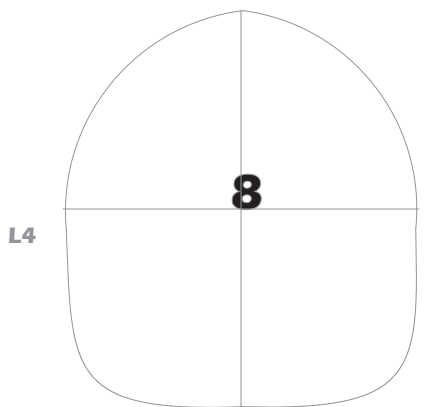
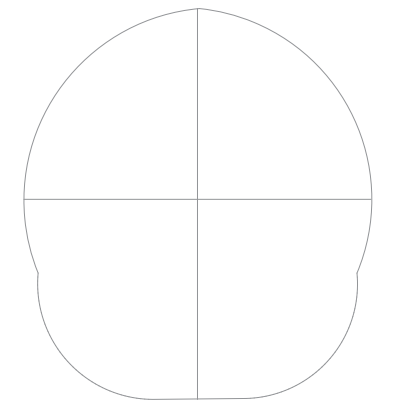
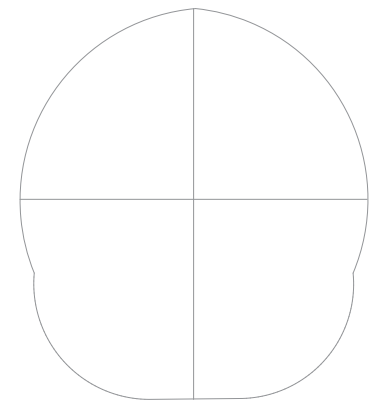
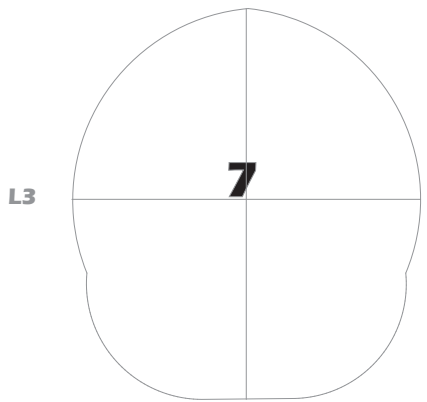
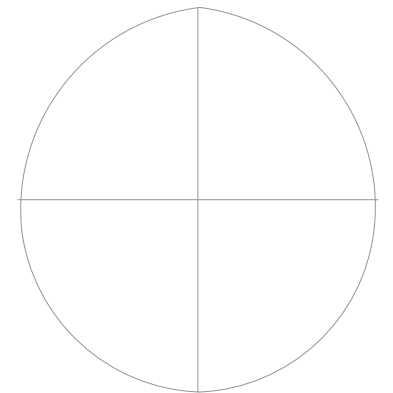
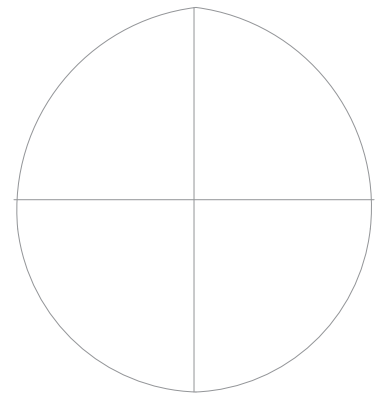
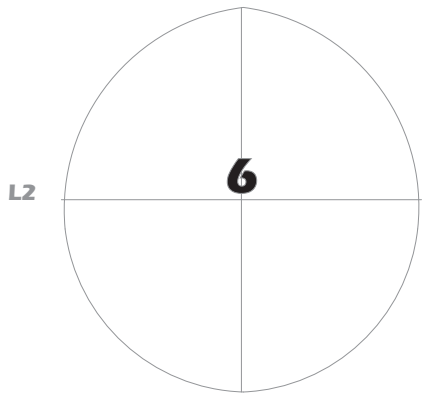
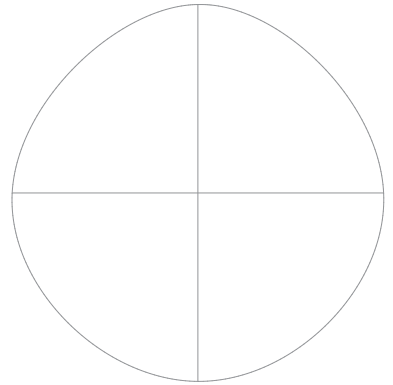
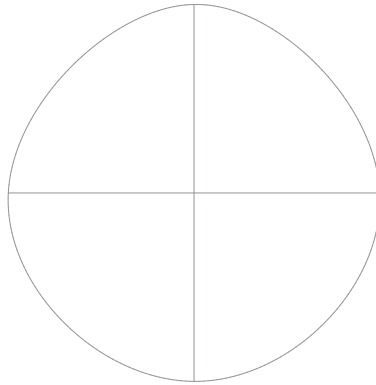
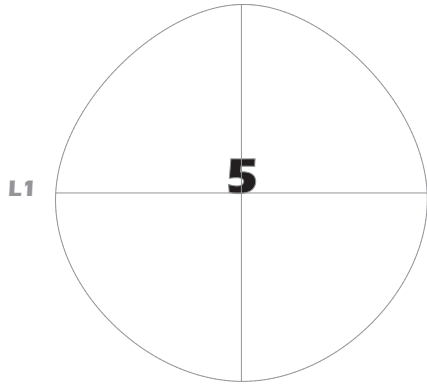

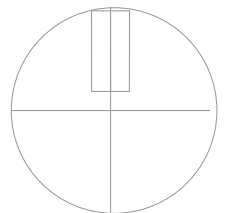
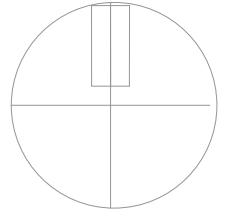
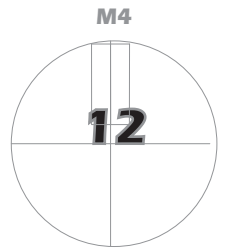
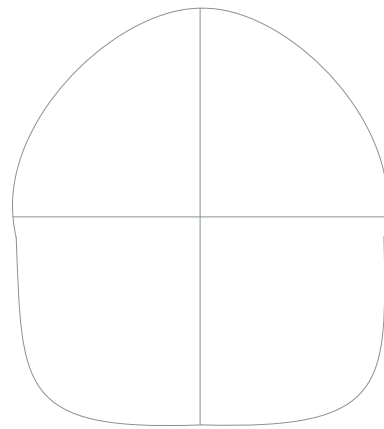
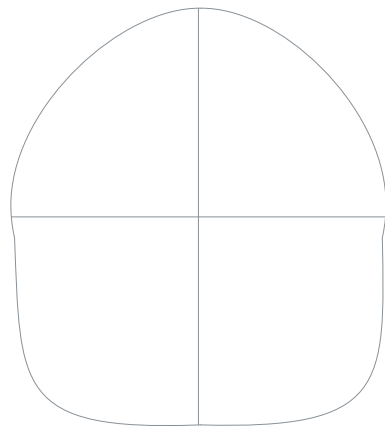
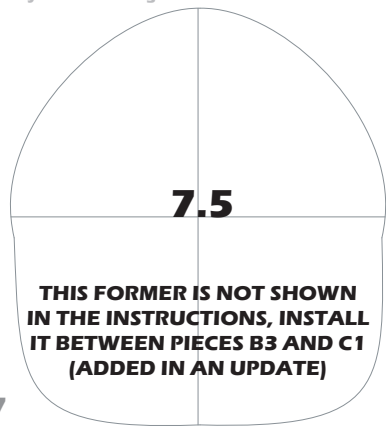

M7

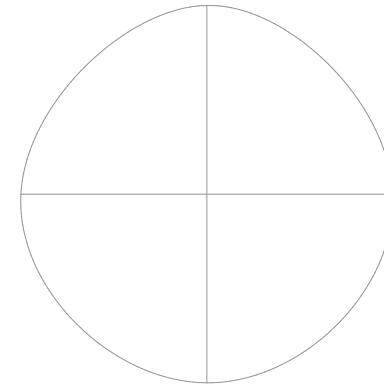
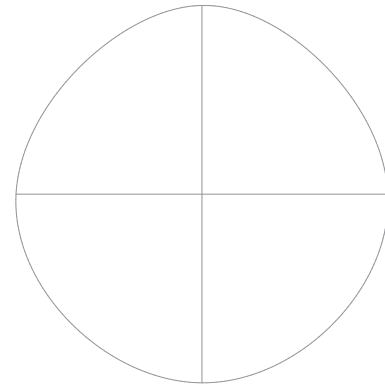
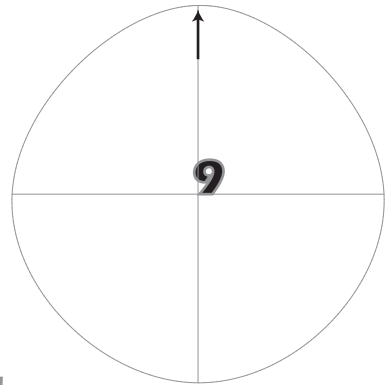

M1

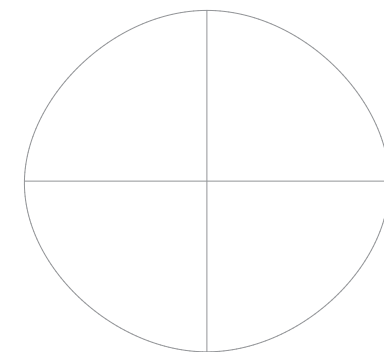
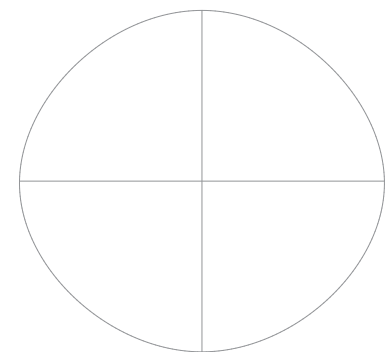
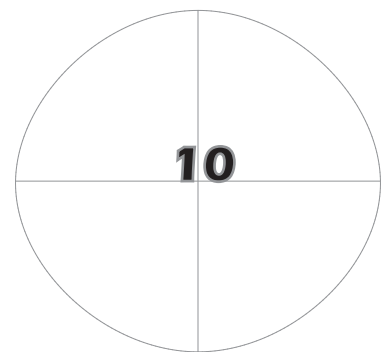

M2

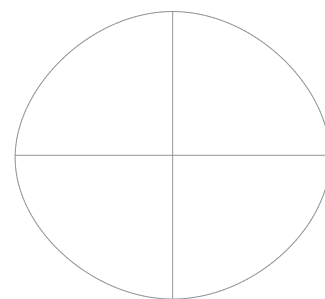
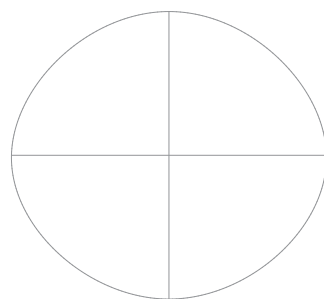
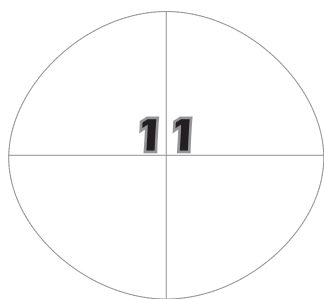

M3

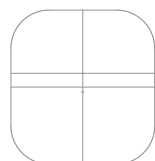
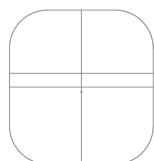

M5

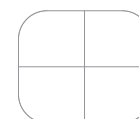
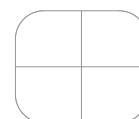

M6

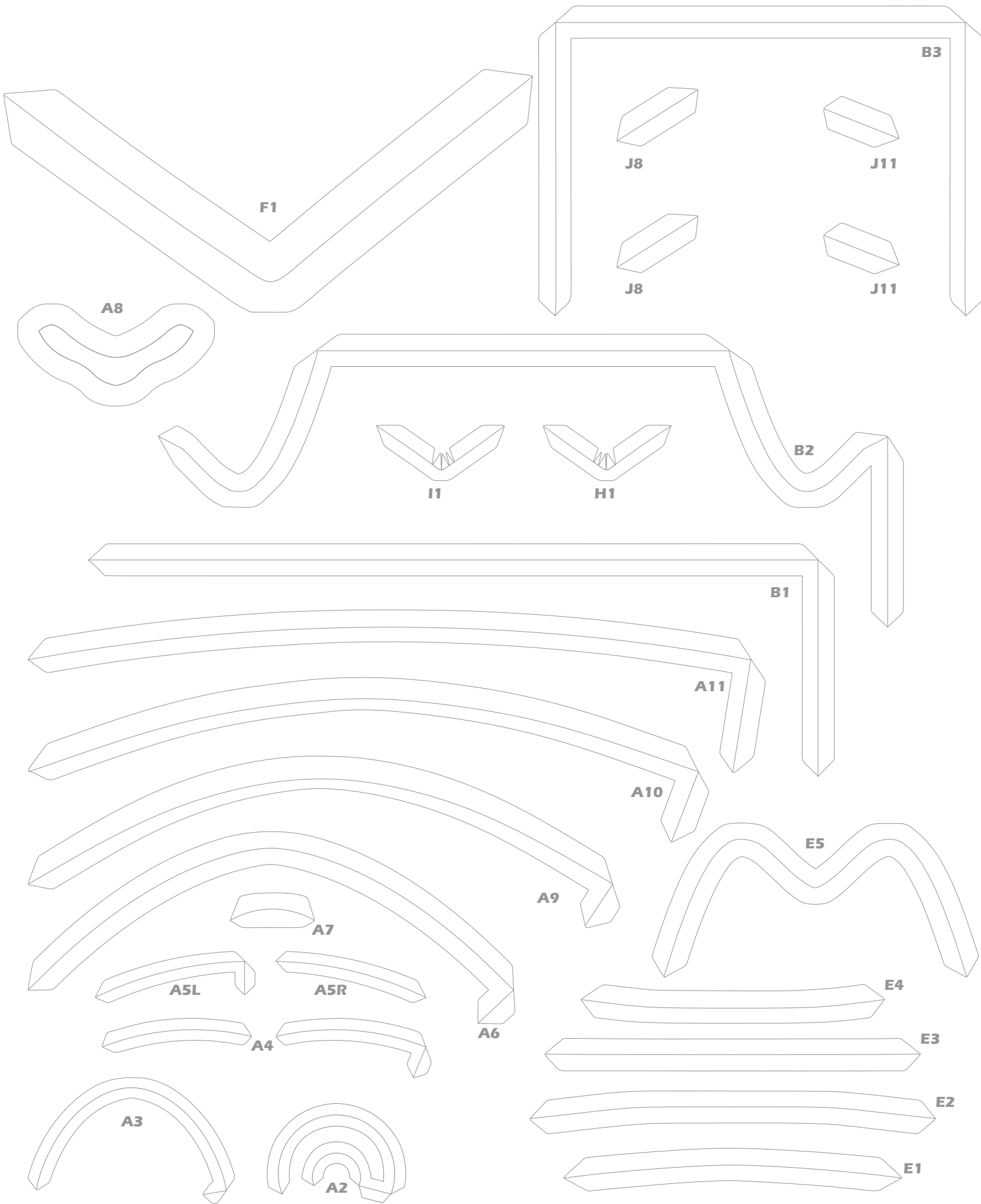

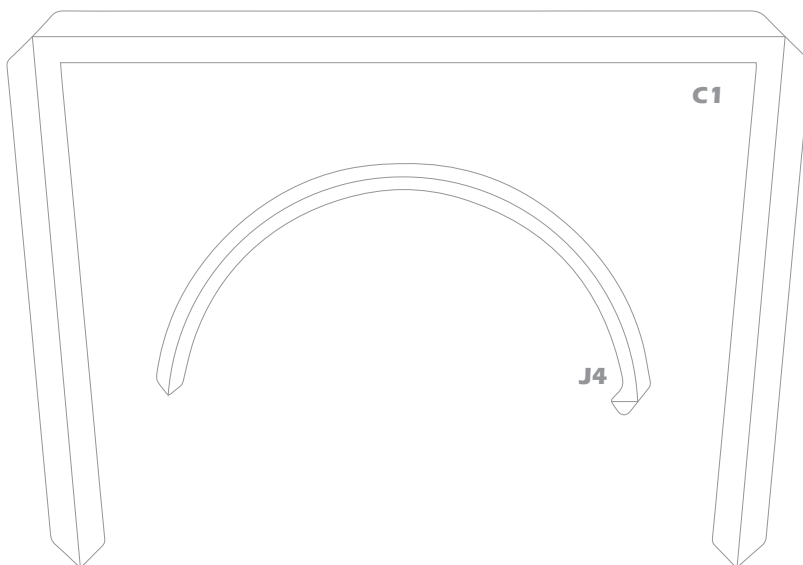
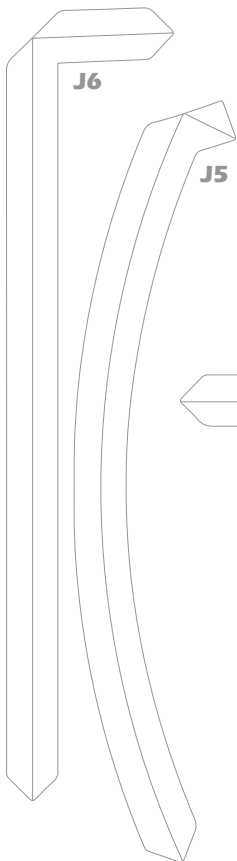
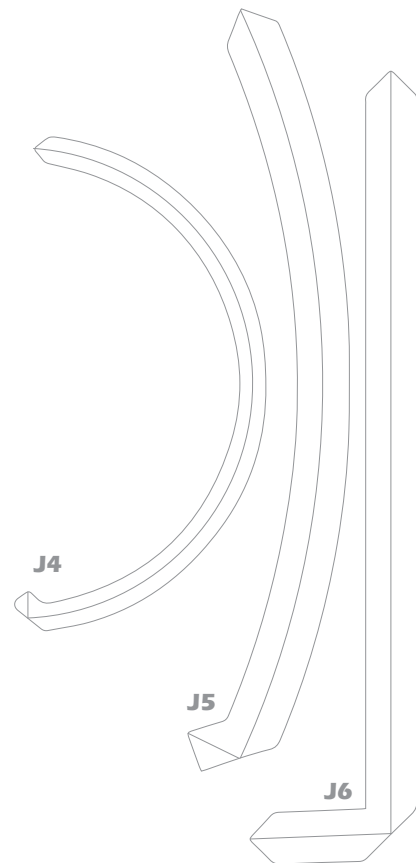
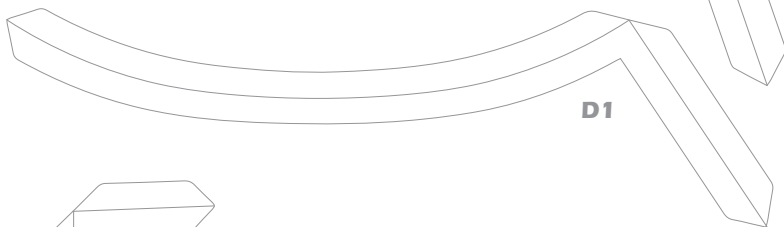
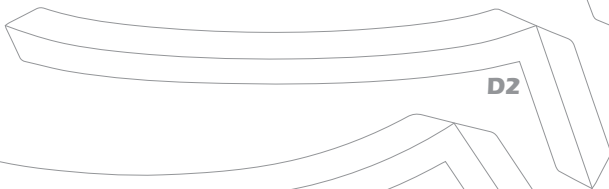
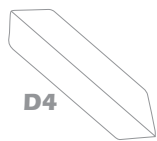
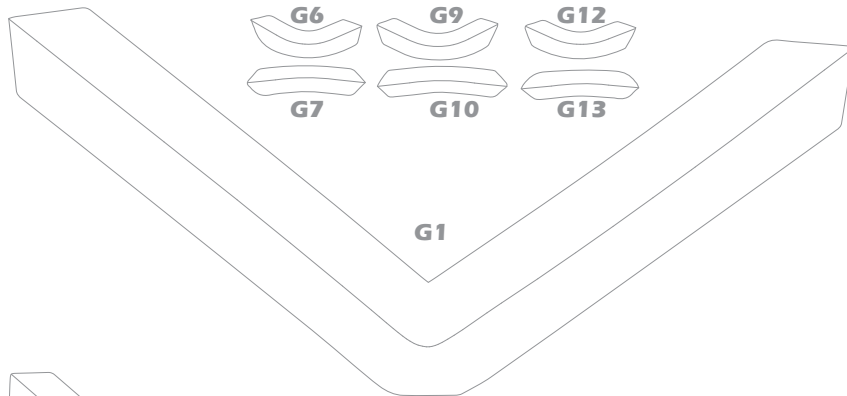
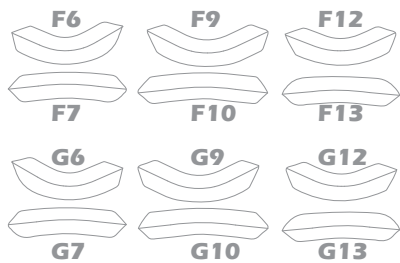

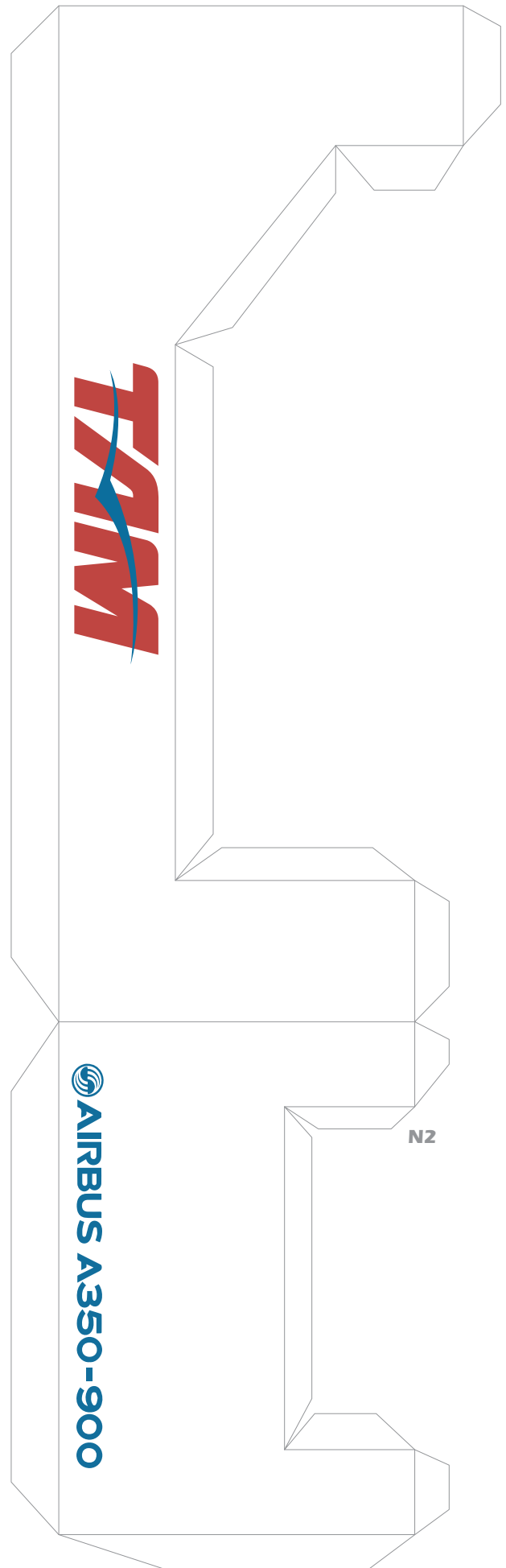
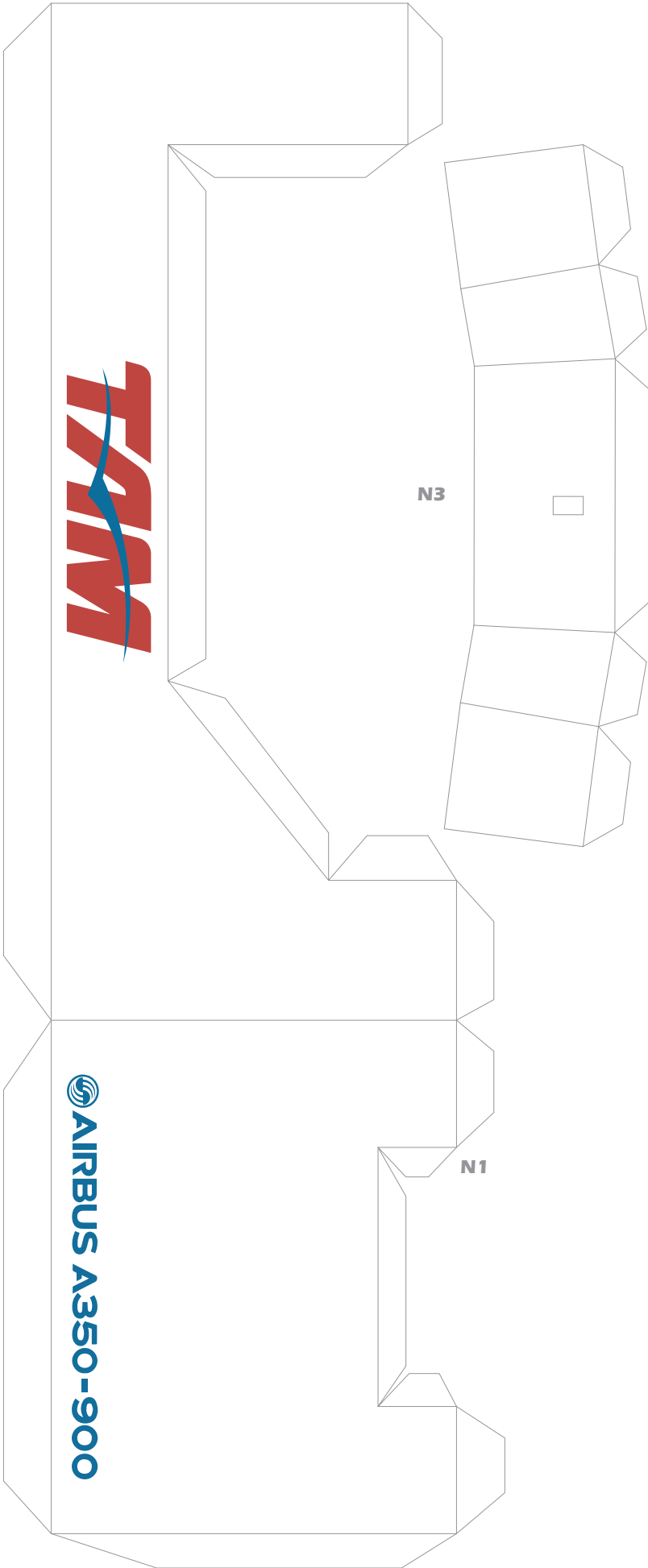



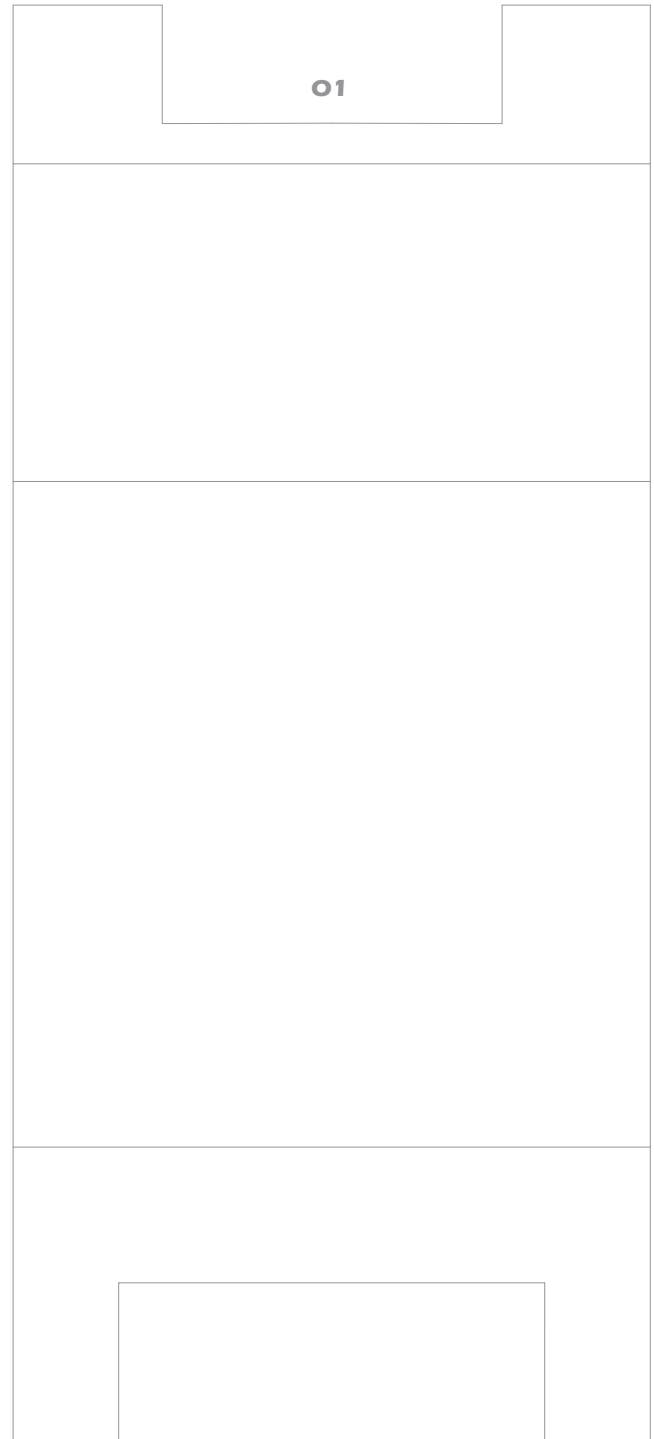
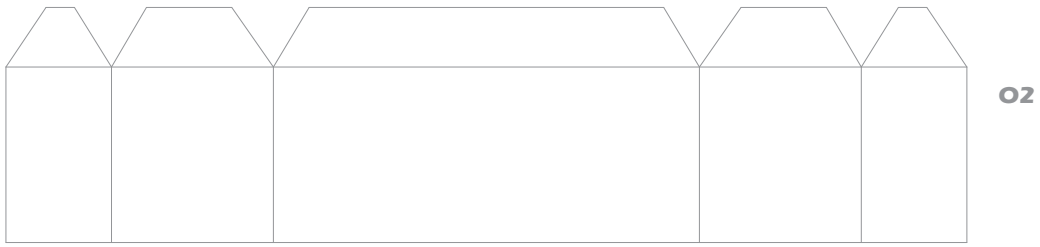

O3

PLEASE DO NOT SELL THIS FILE | DESIGNED IN PALMARES, COSTA RICA

HERMERCRAFT

ORIGINAL MODEL DESIGNED BY EDWIN RODRIGUEZ