

- B5* 
- B7* 
- B9* 
- B6* 
- B8* 
- B10* 

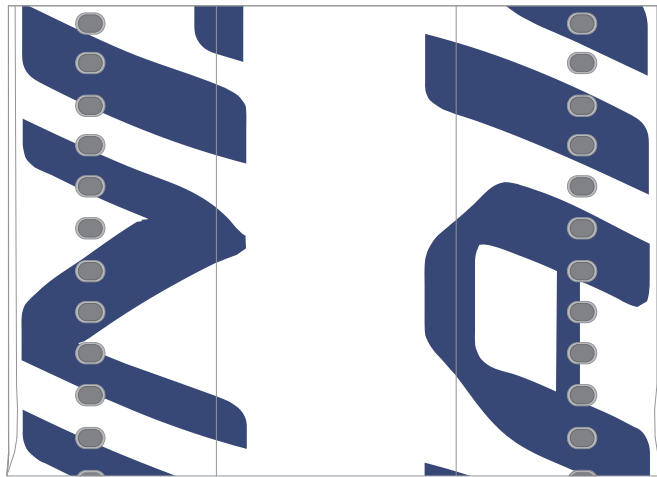

B4

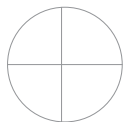
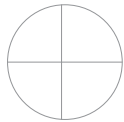

B3

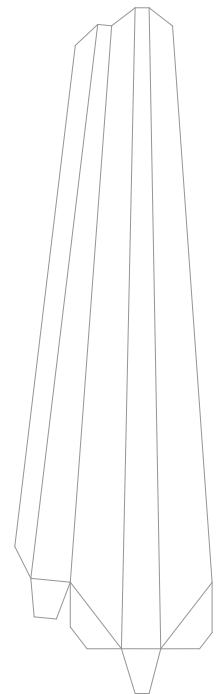

B13

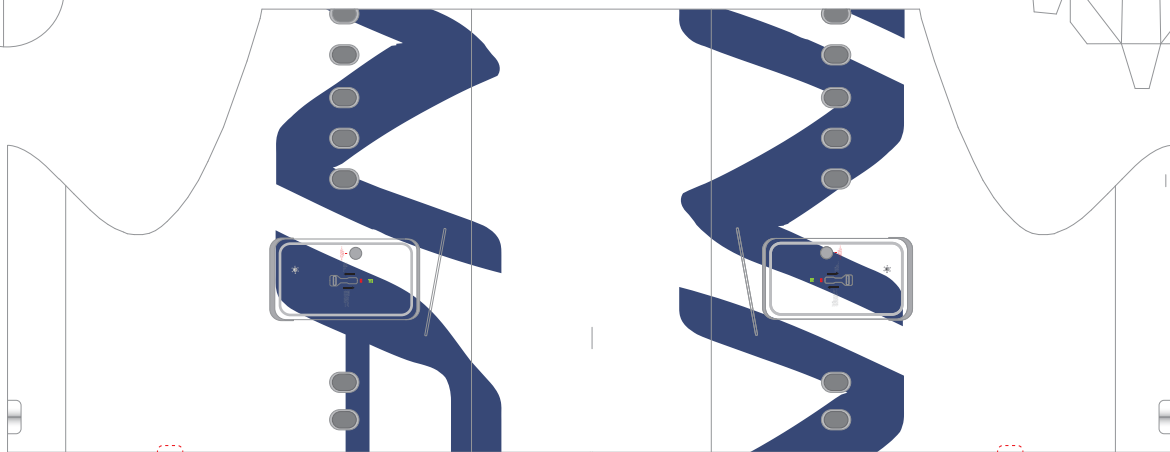

B2

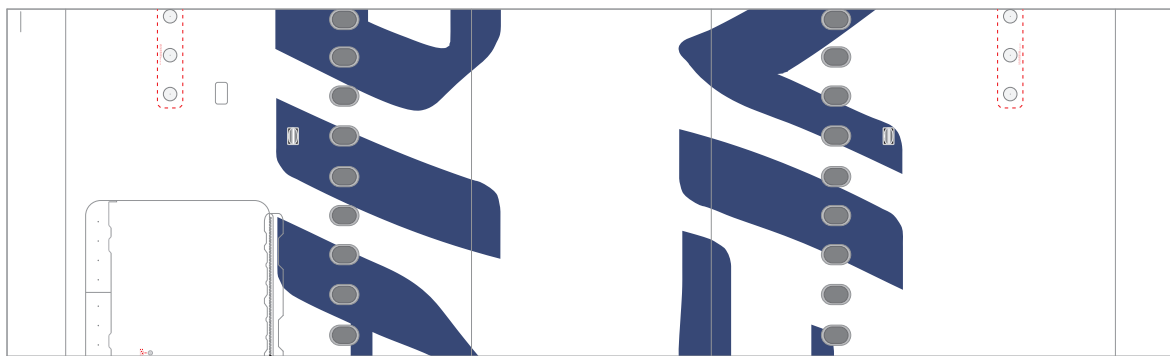

B1



B12R



B11



B12L

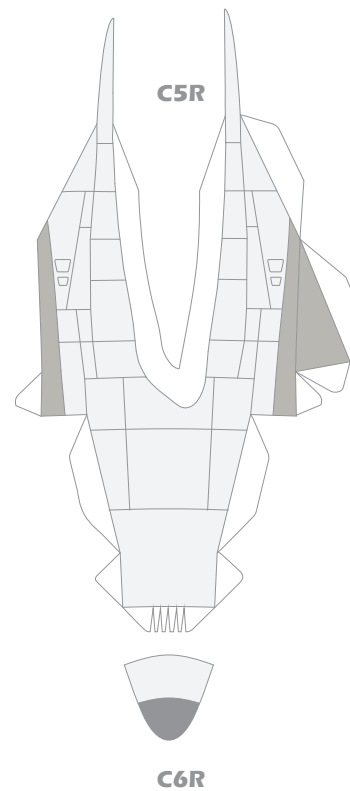
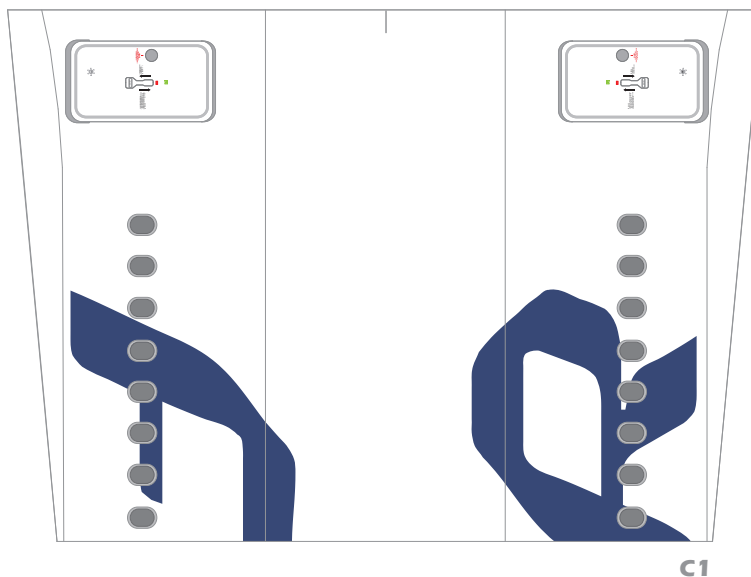
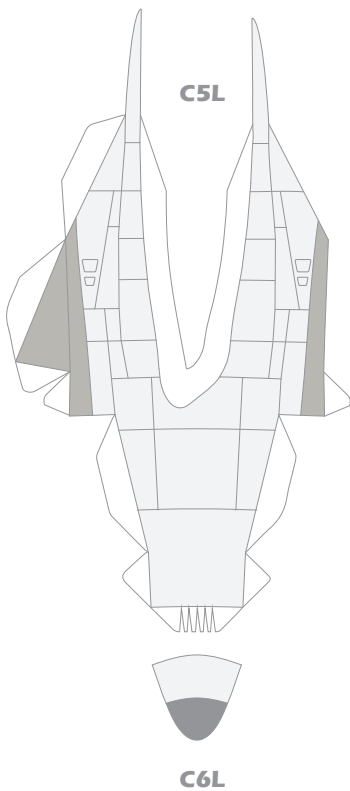
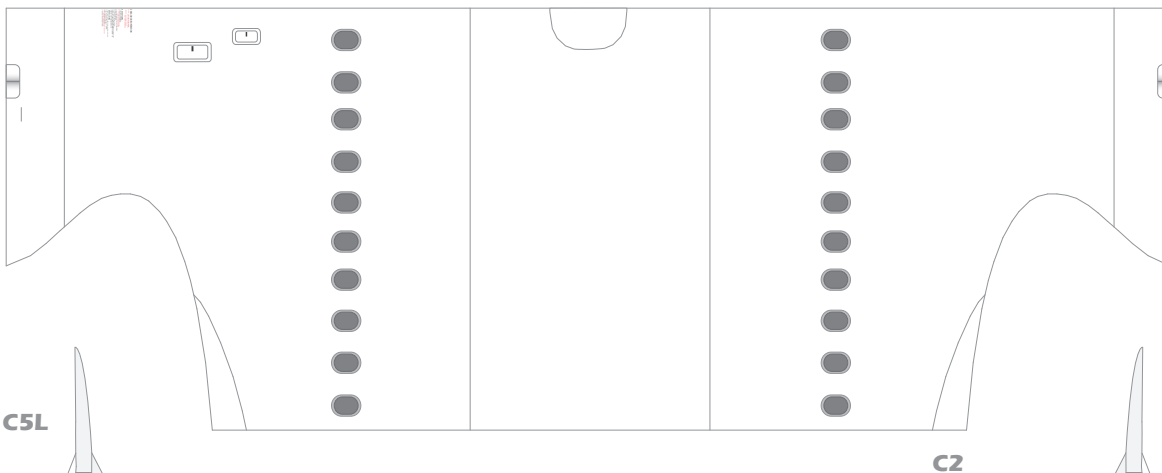
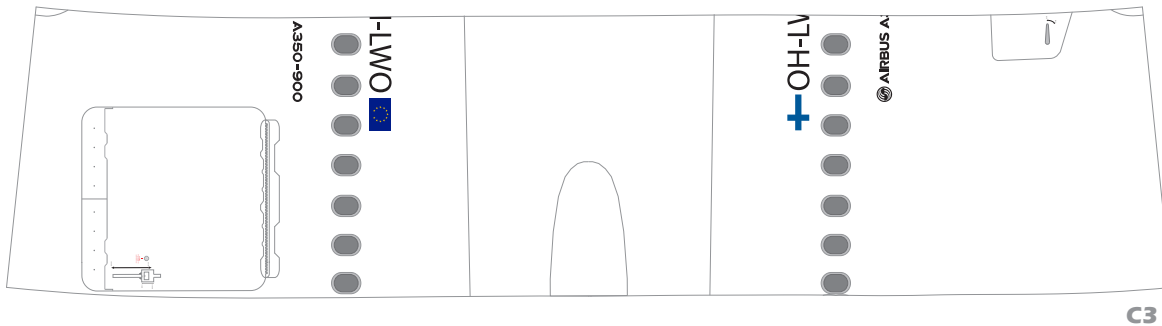
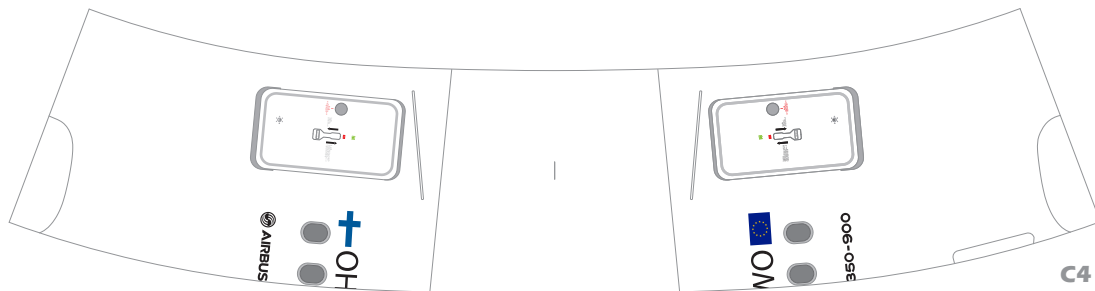

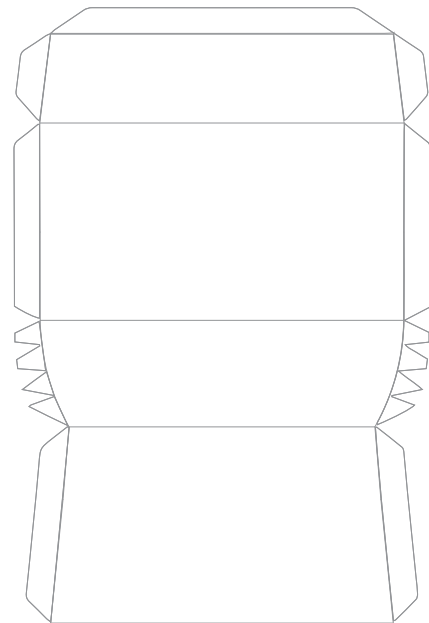
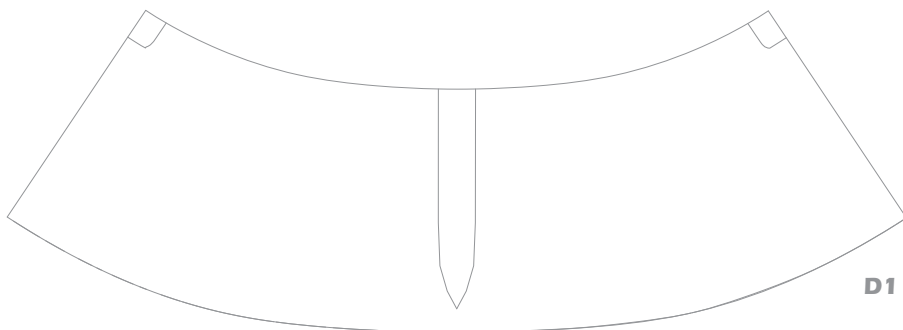
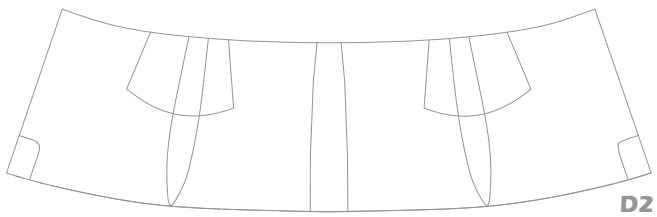
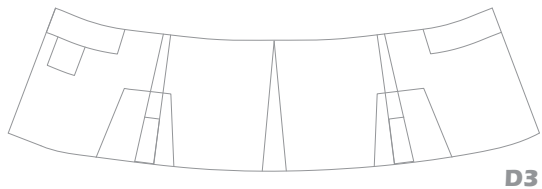
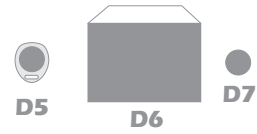
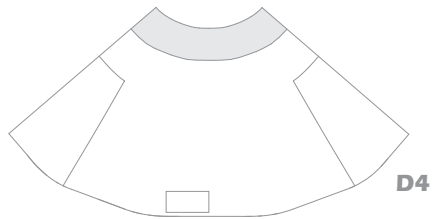
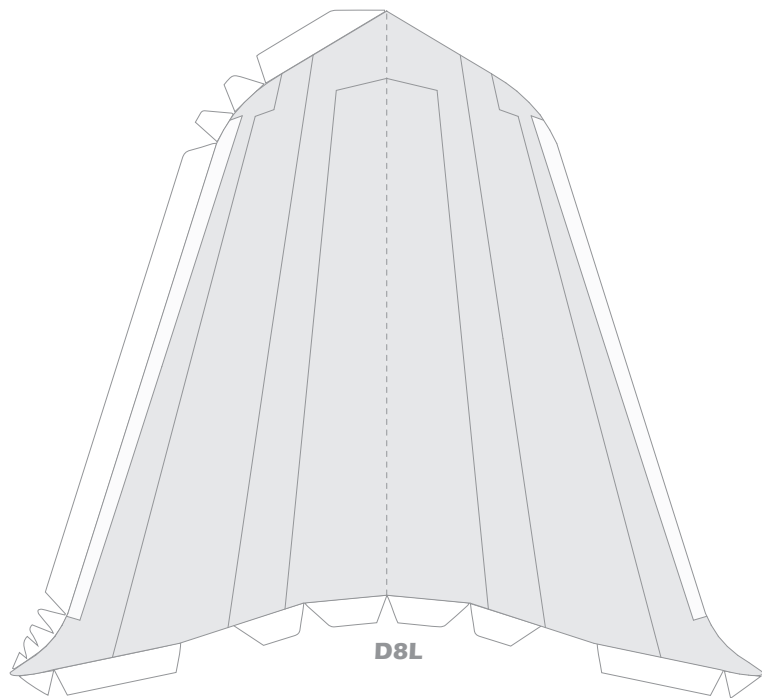
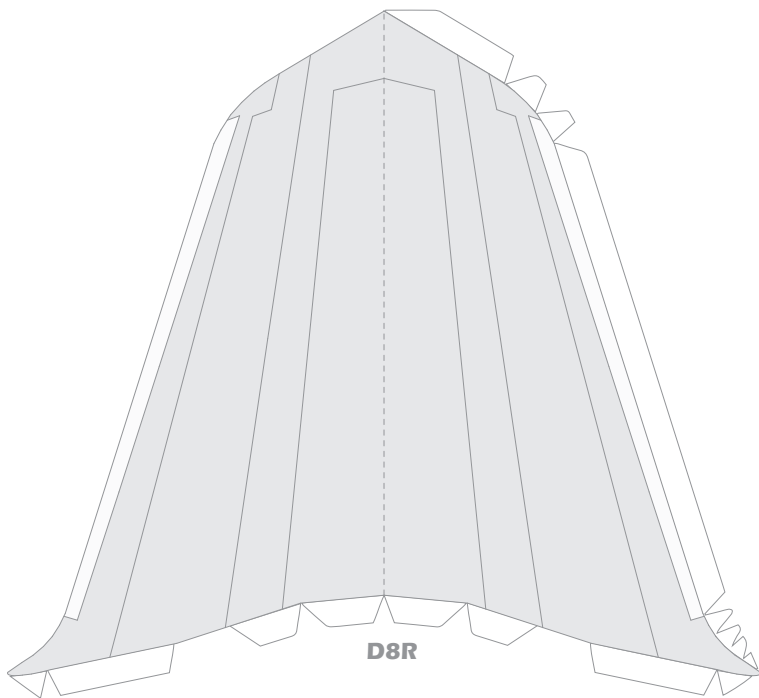

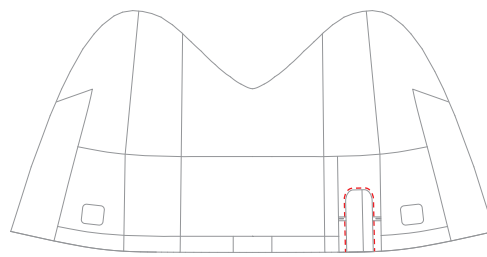
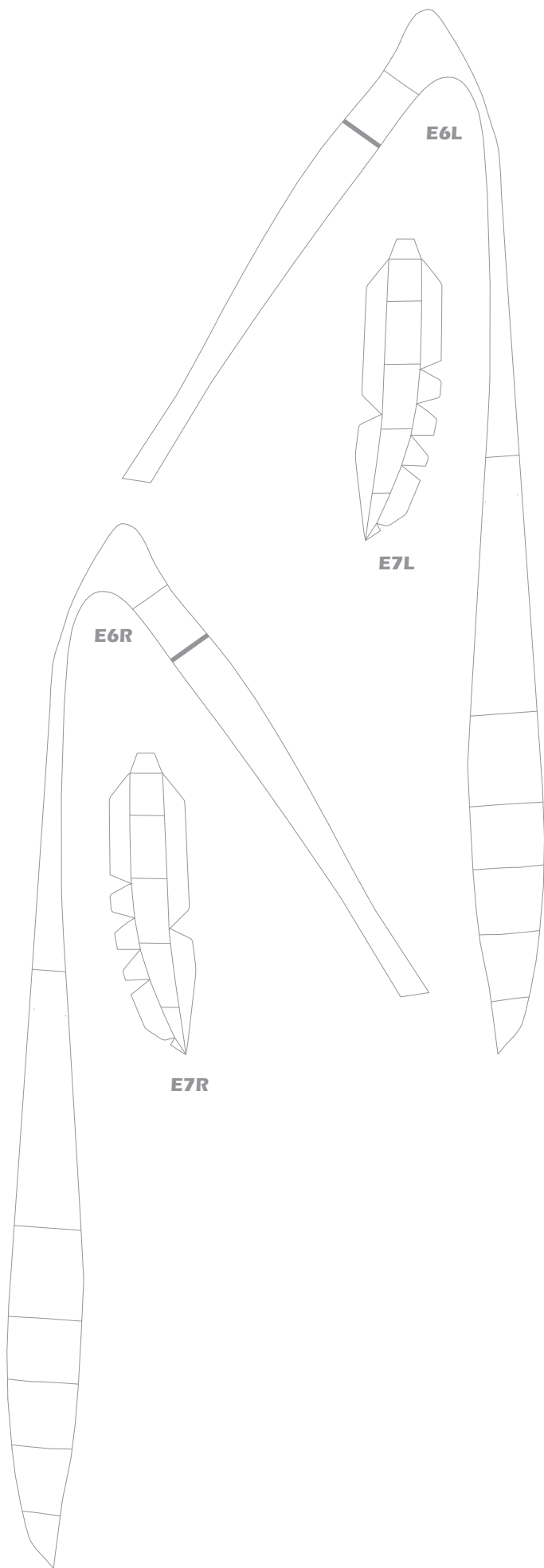

E5



E4

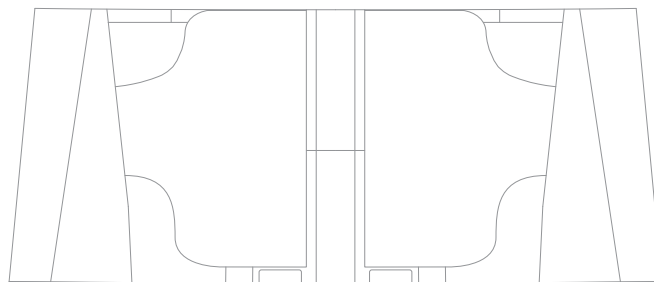

E3

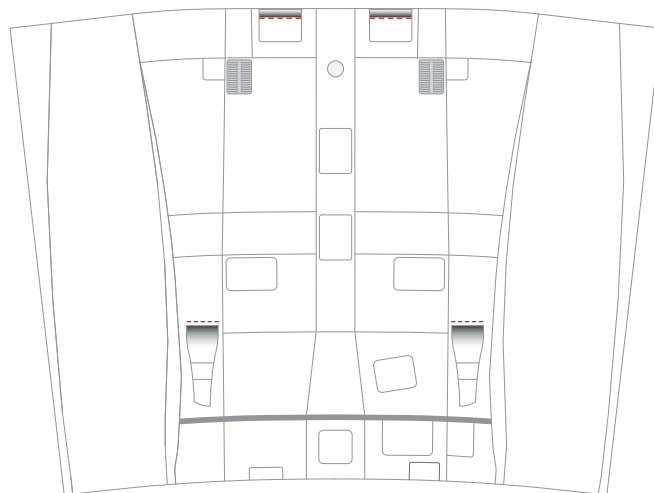

E2

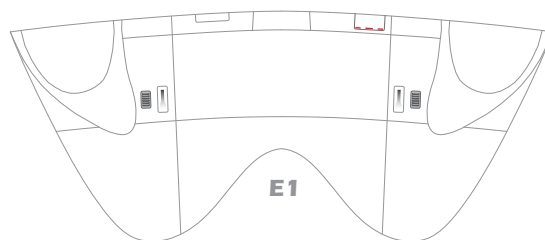

E1

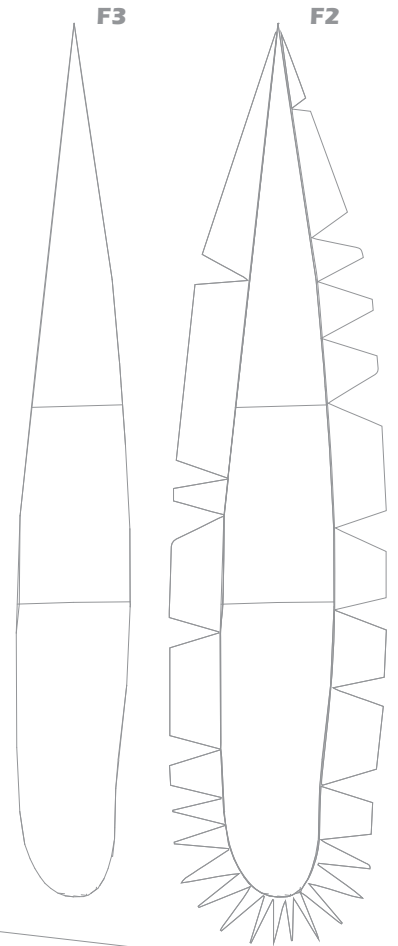
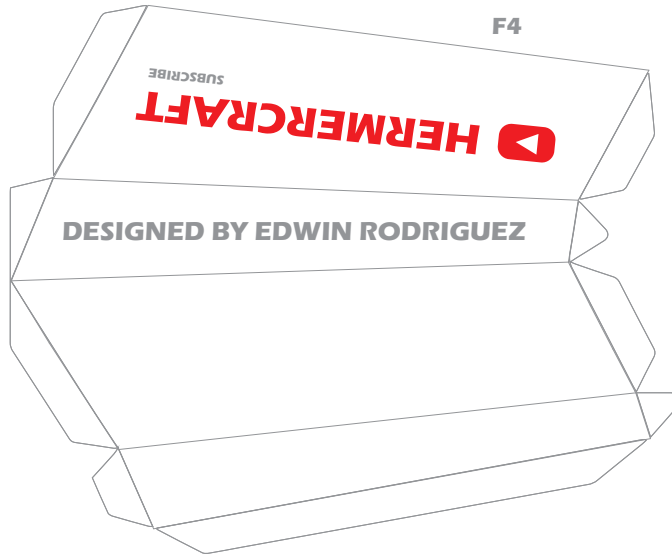
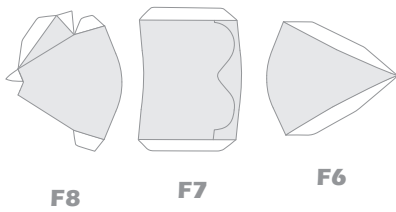
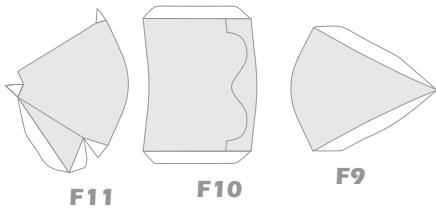
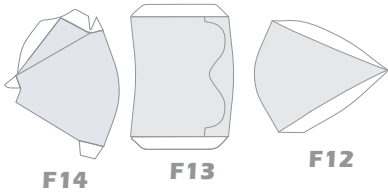
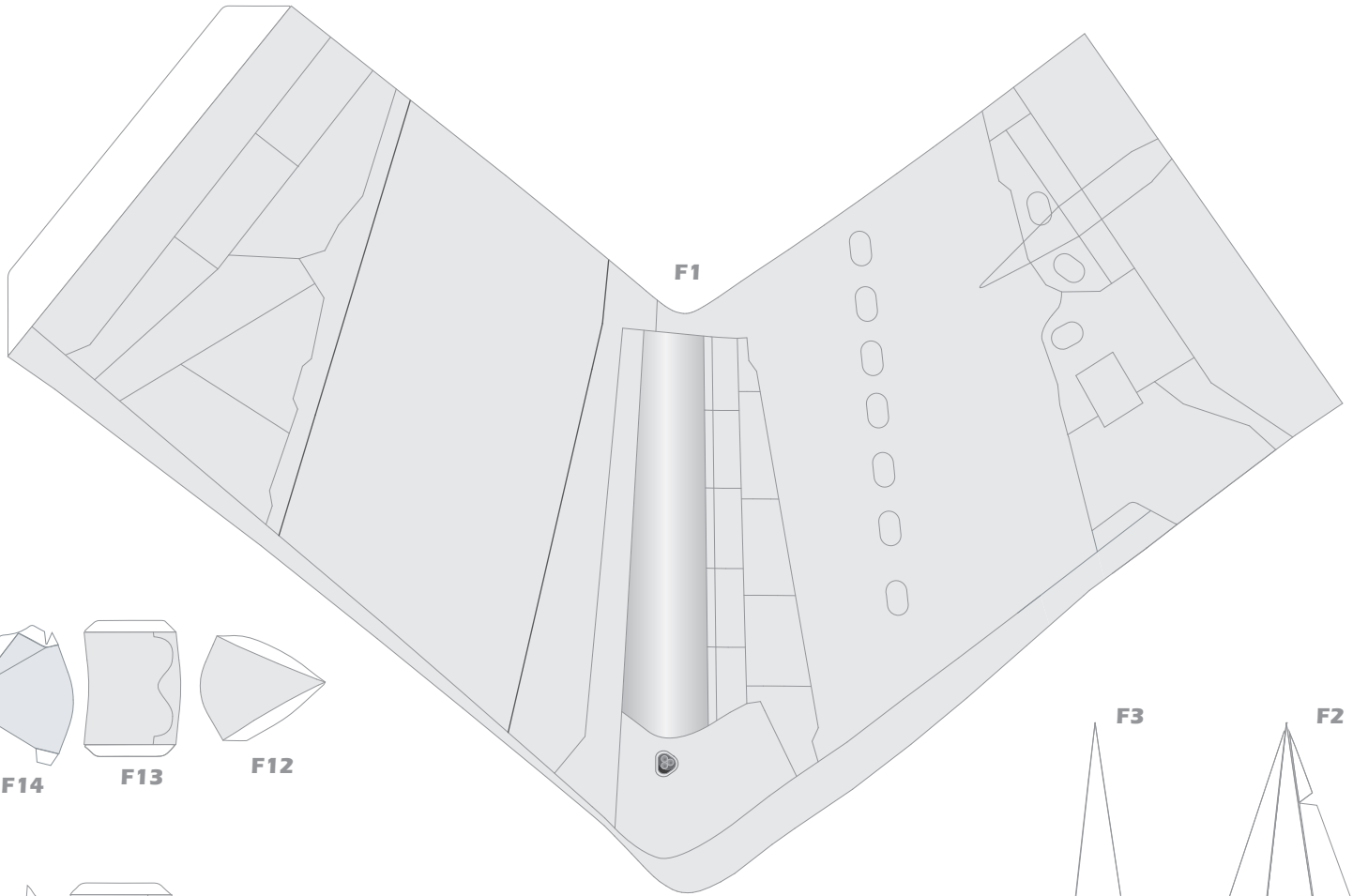

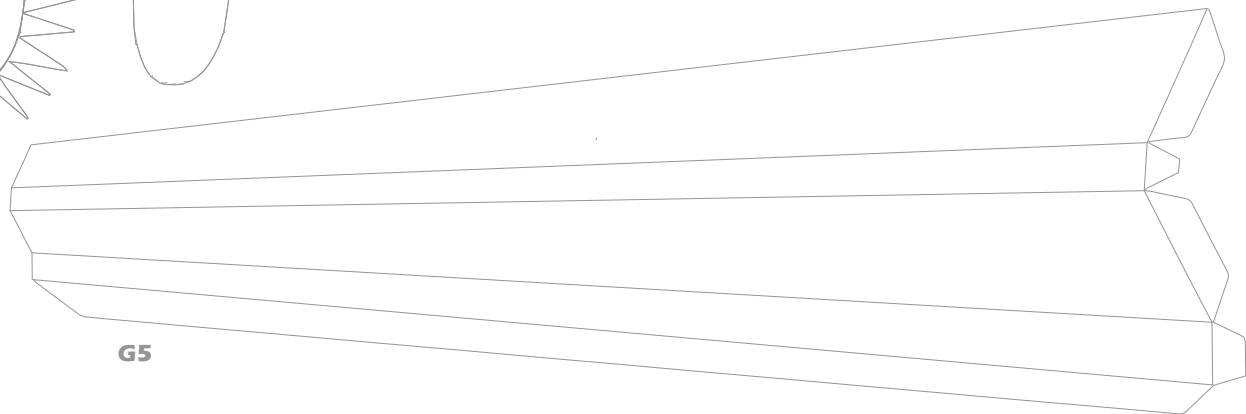
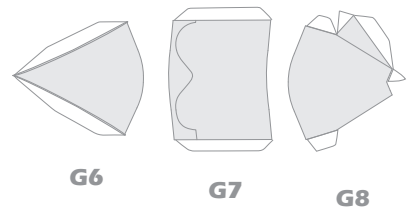
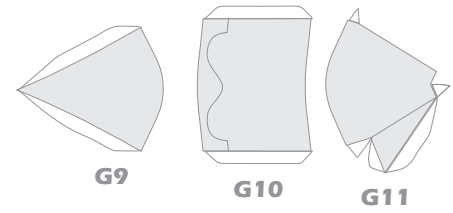
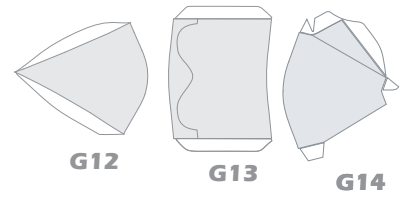
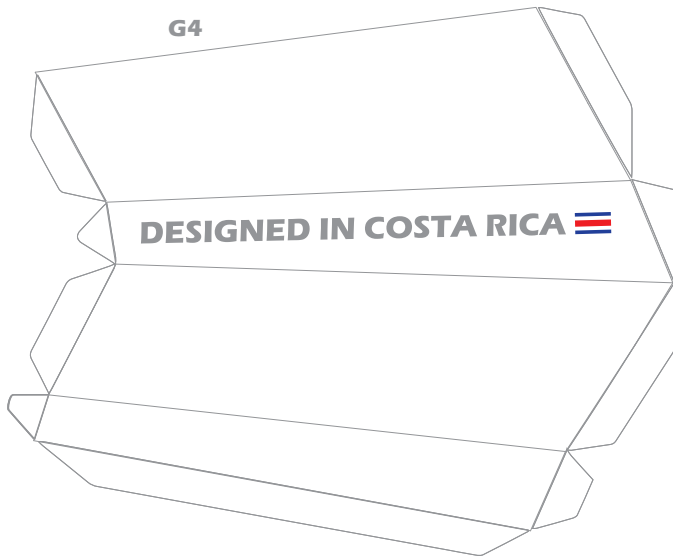
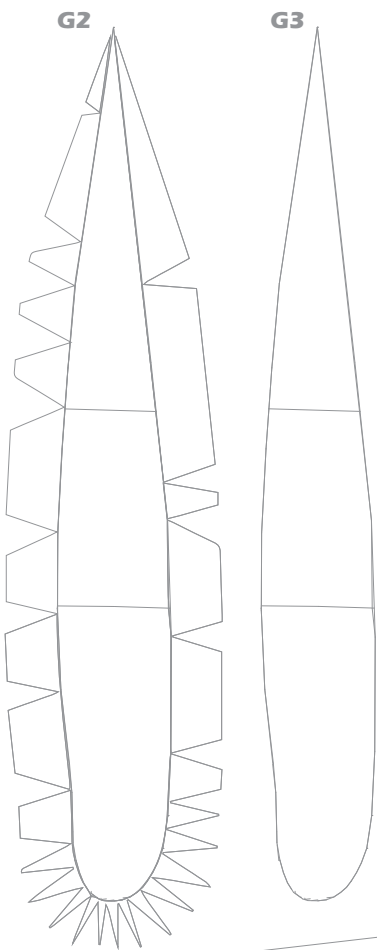
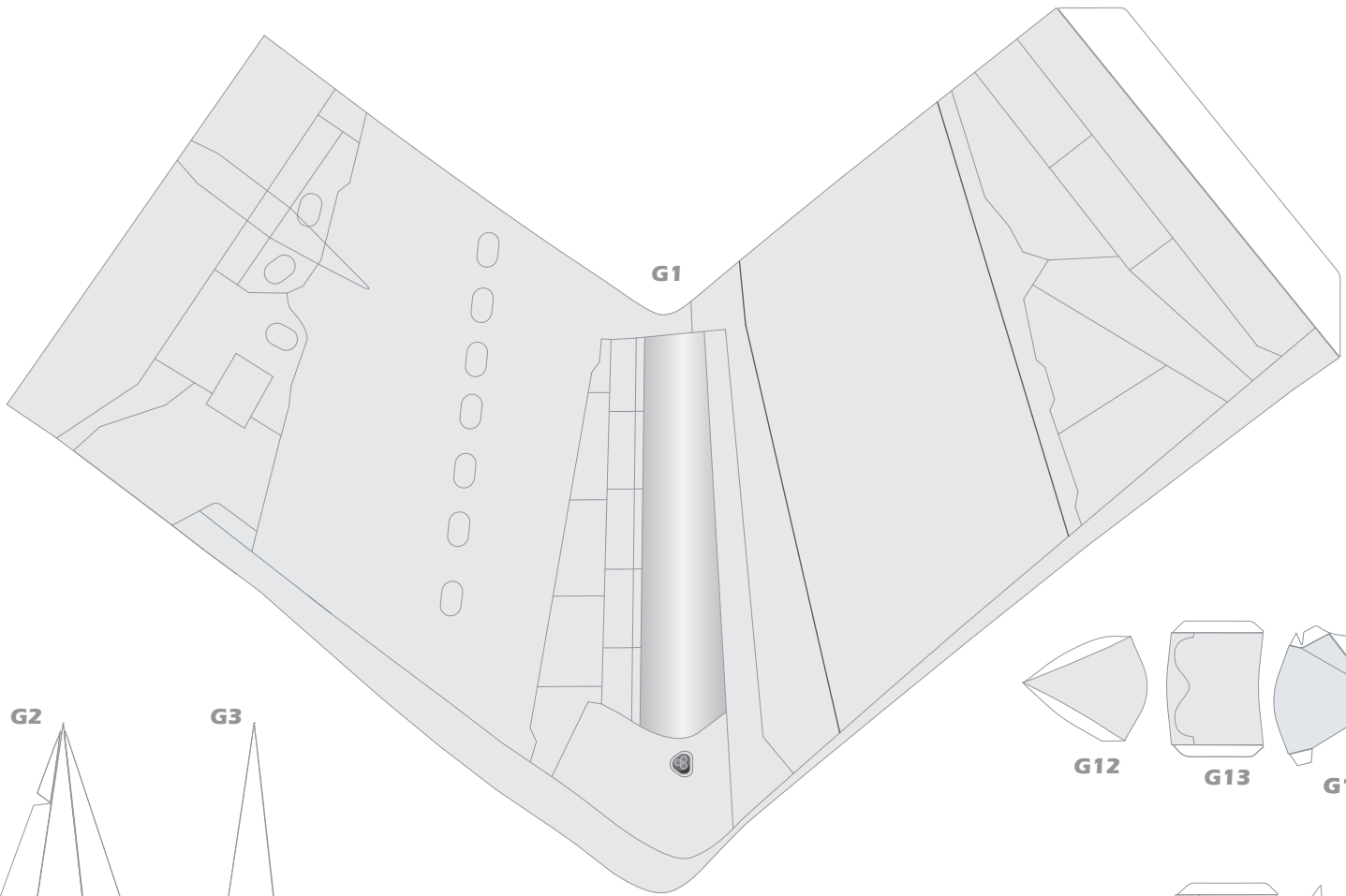

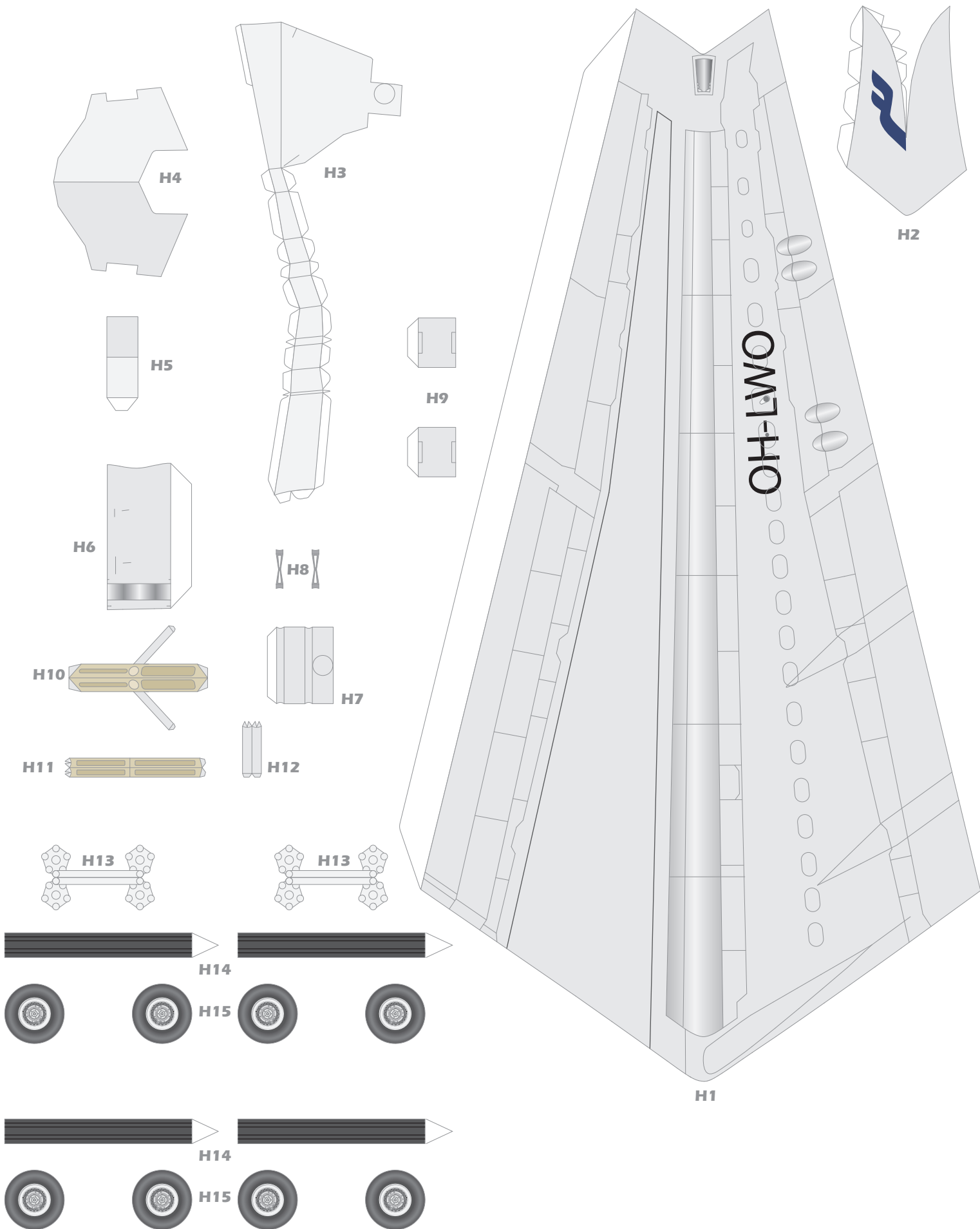

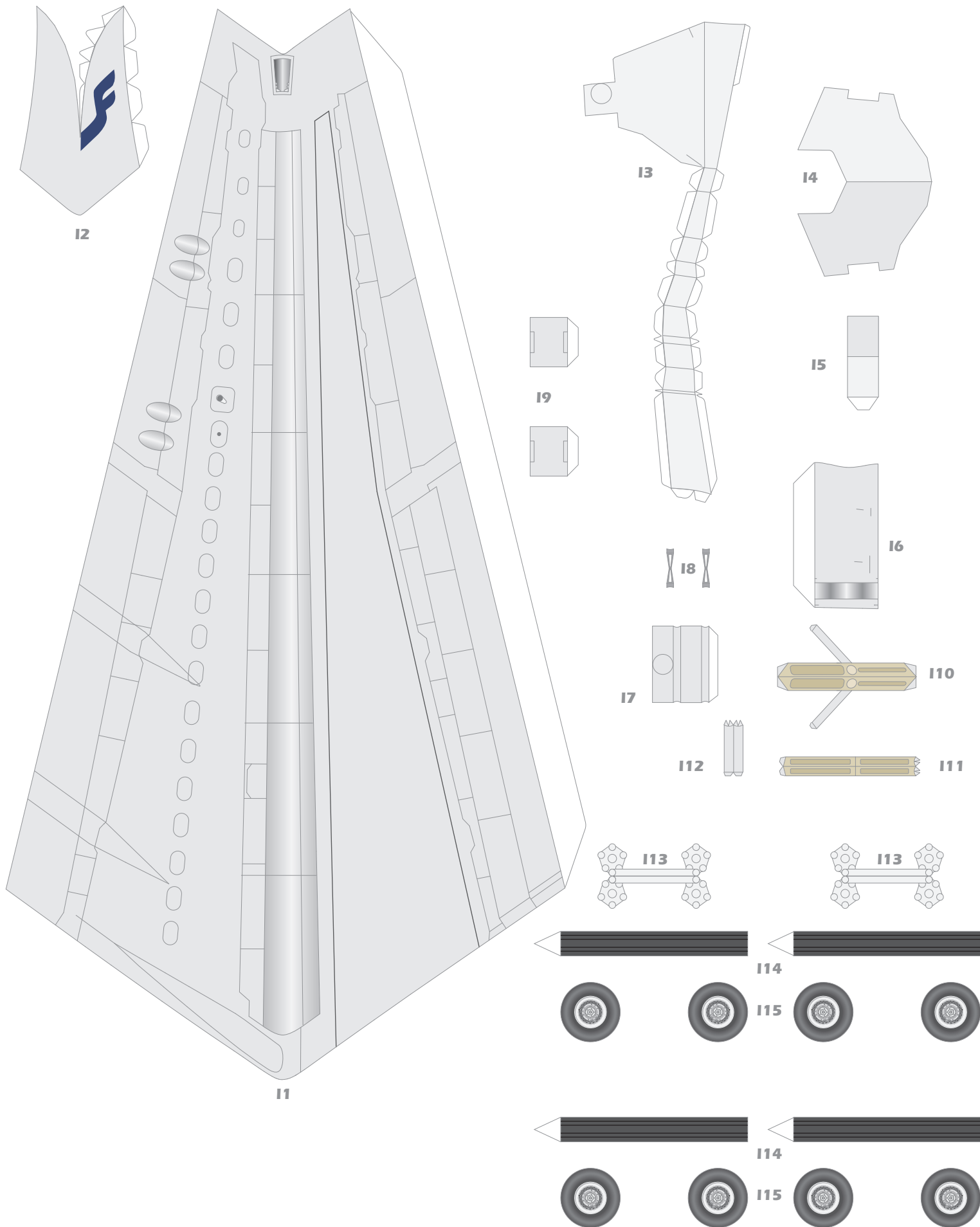

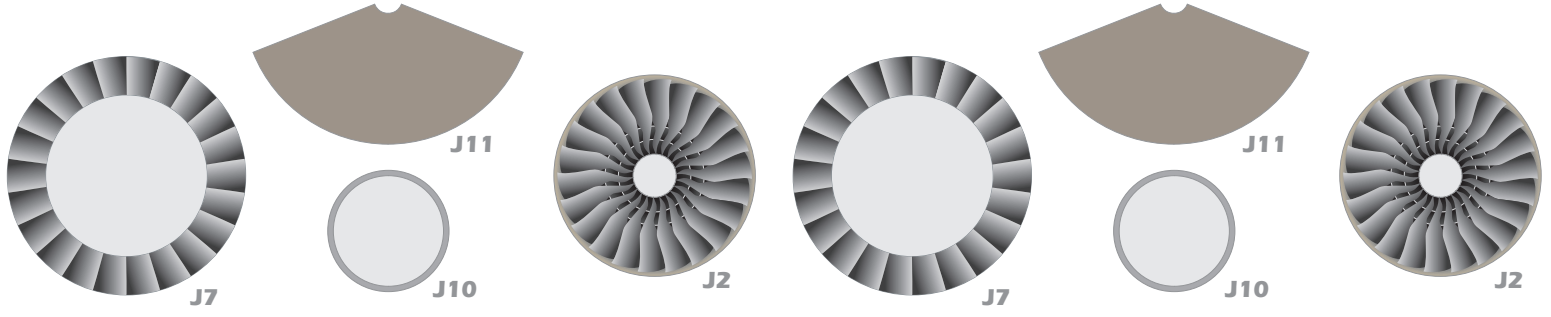
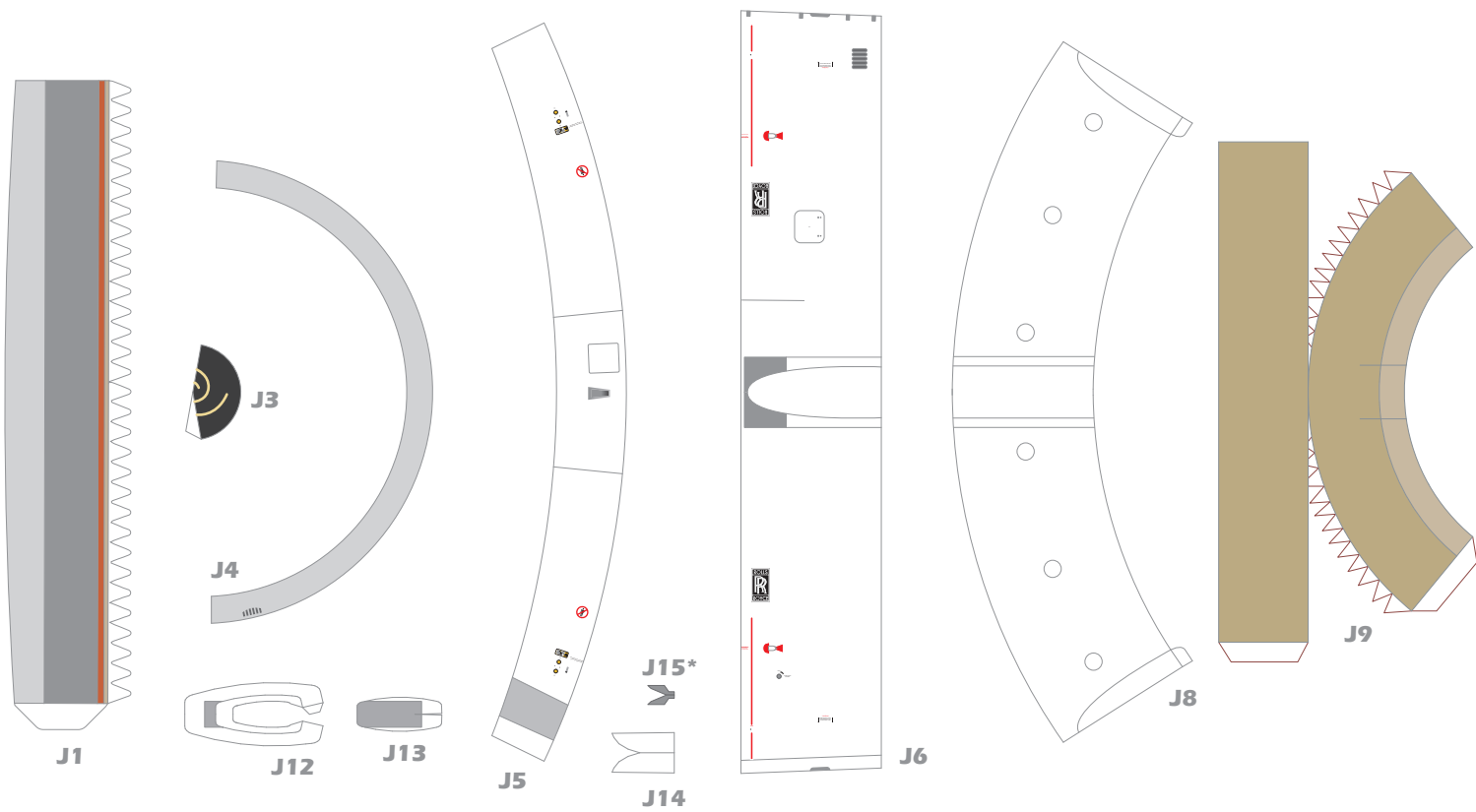
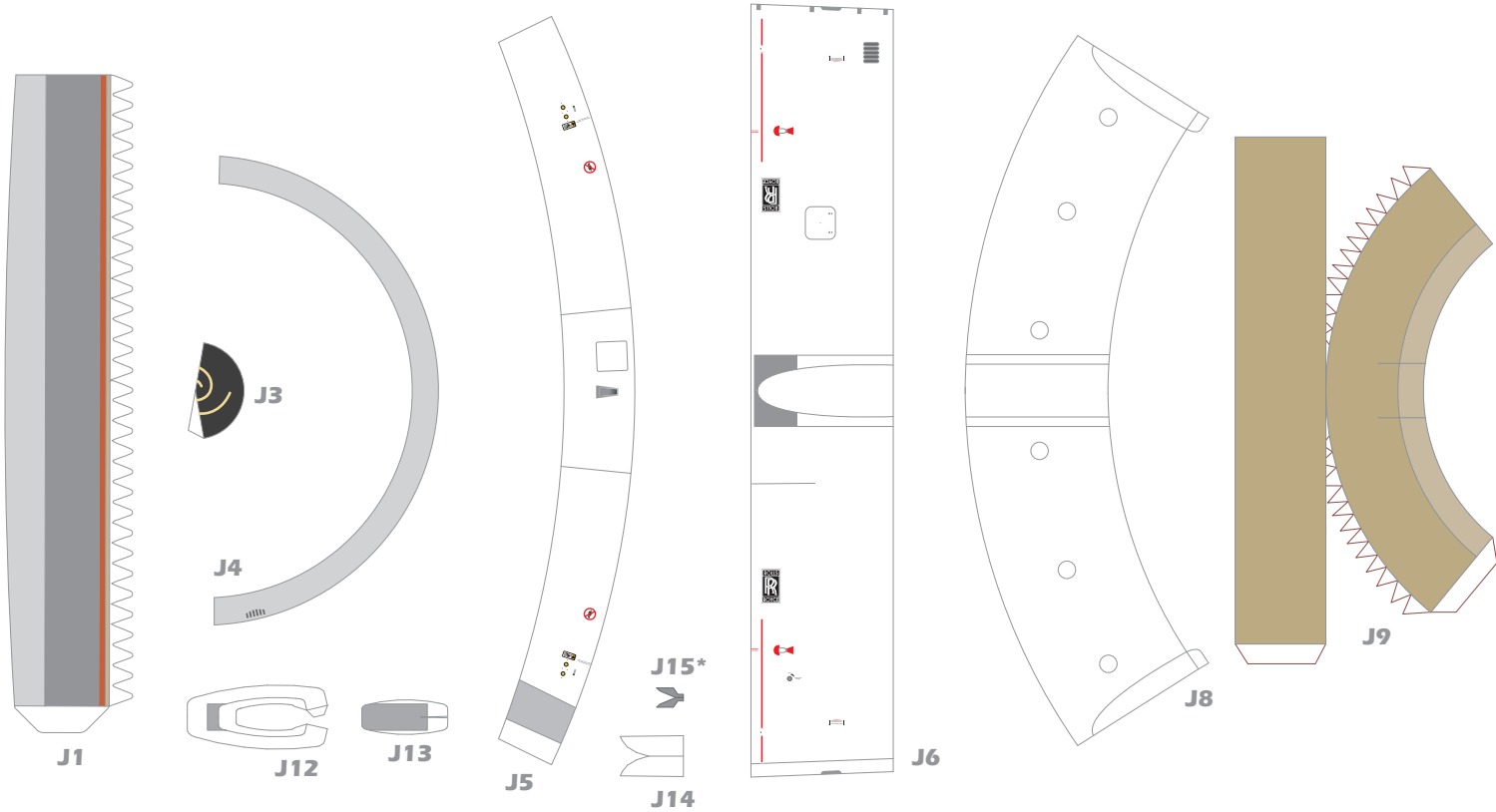

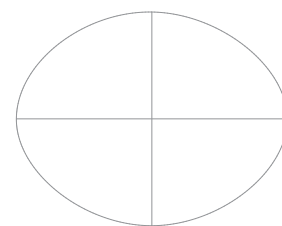
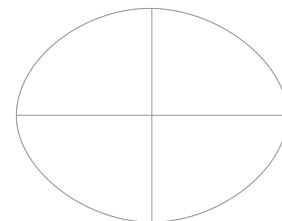
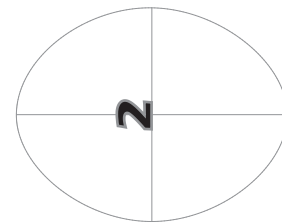
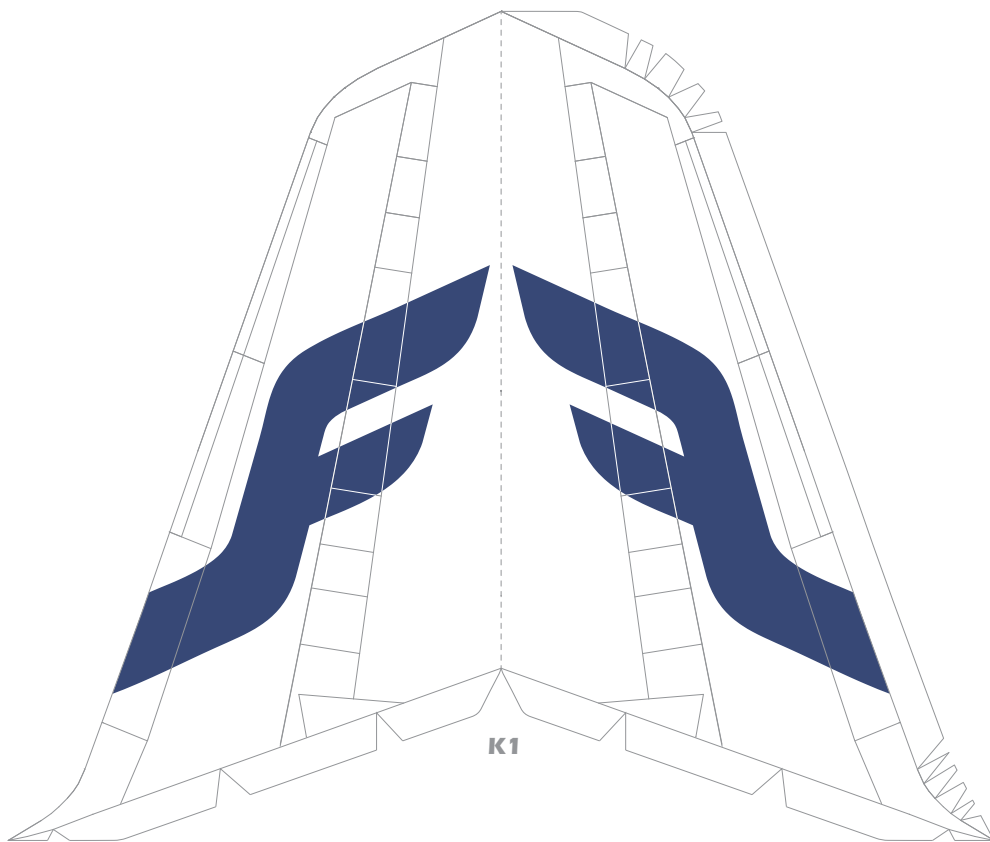

K2

K3

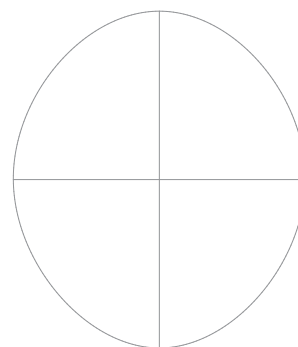
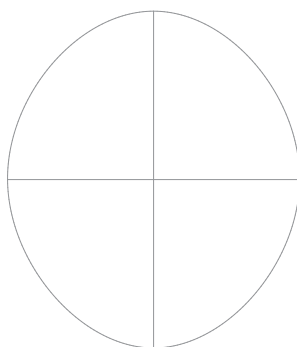
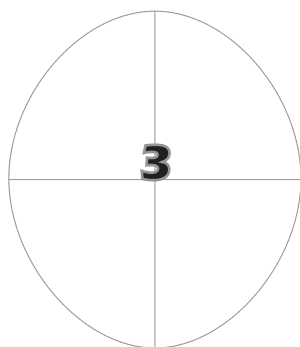

K4

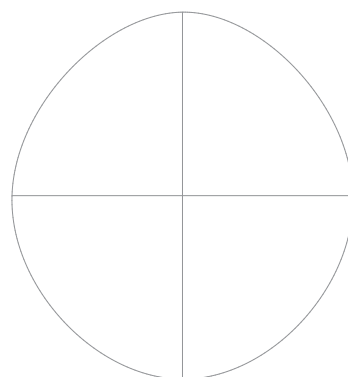
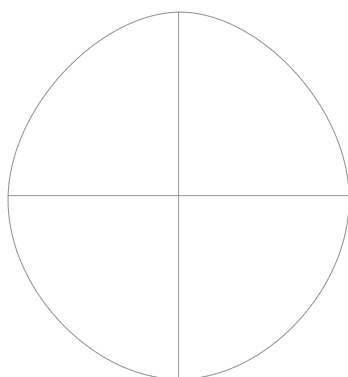
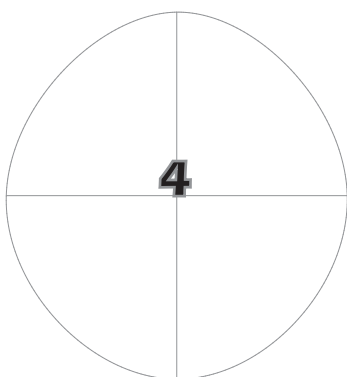

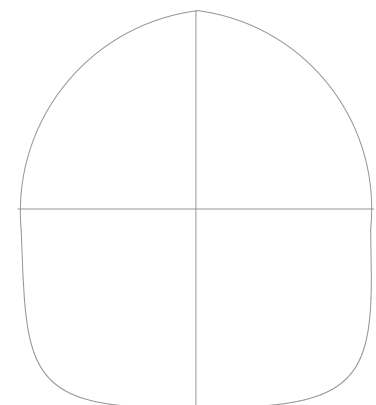
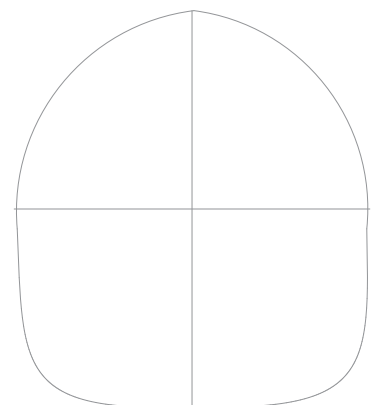
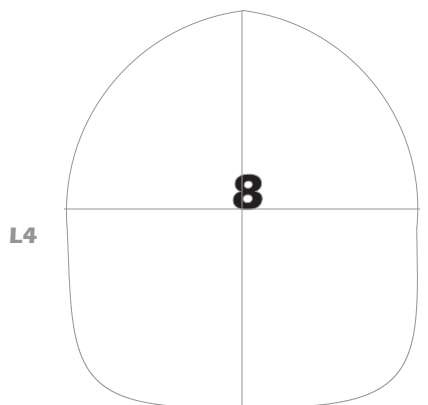
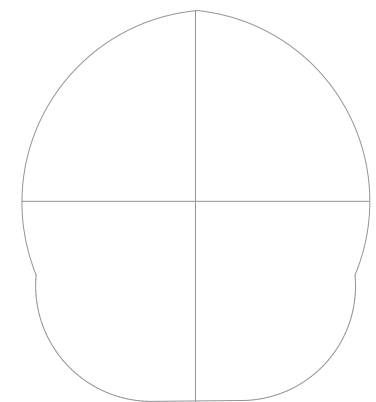
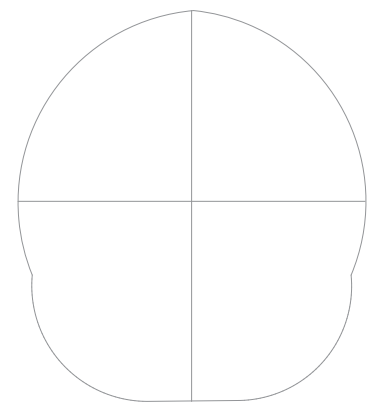
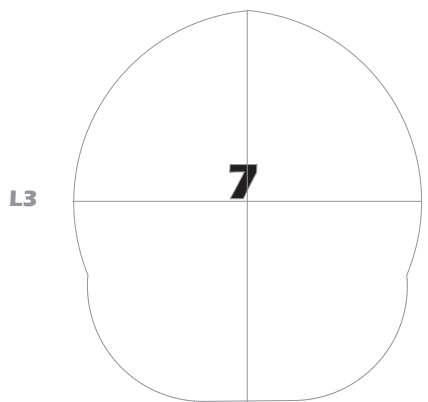
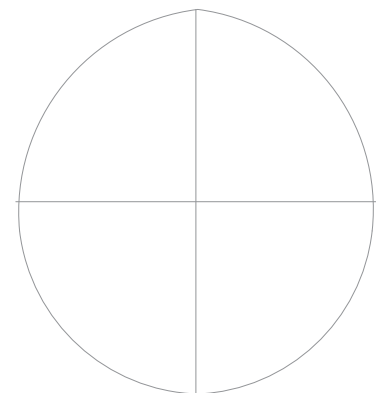
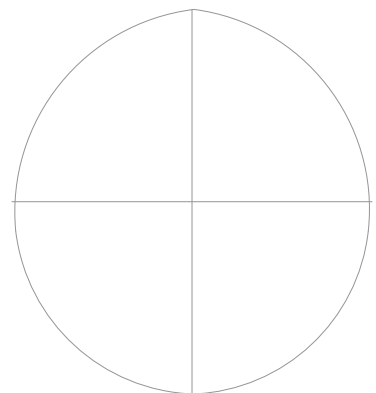
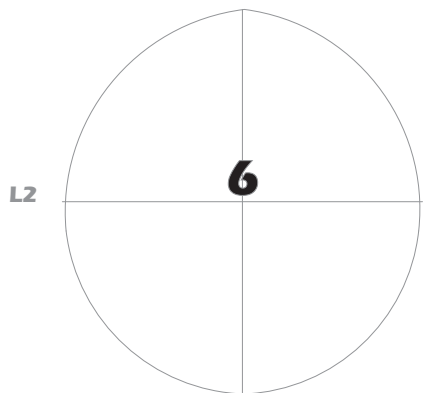
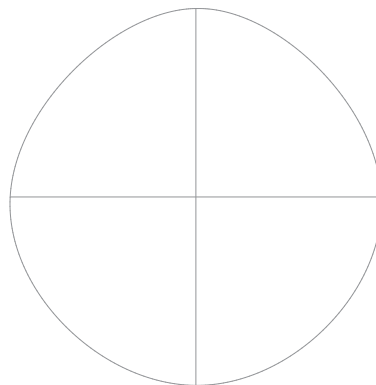
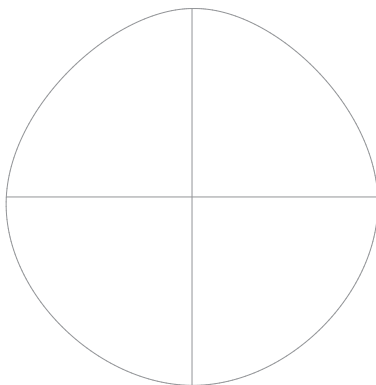
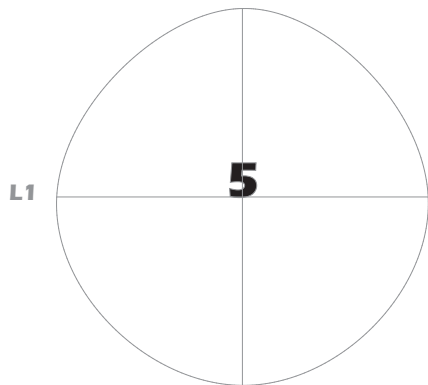

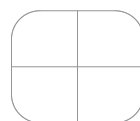
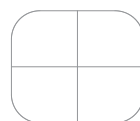
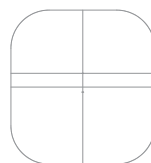
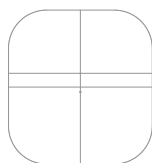
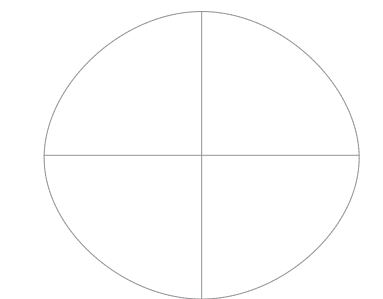
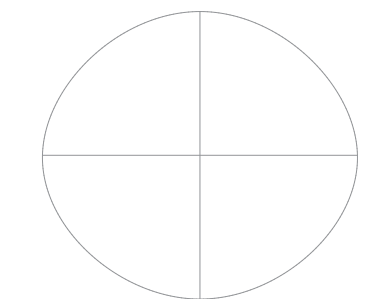
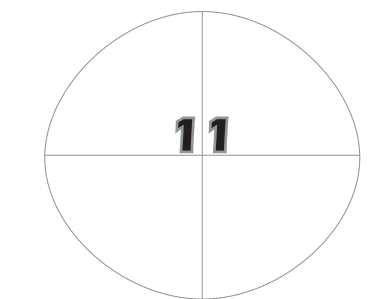
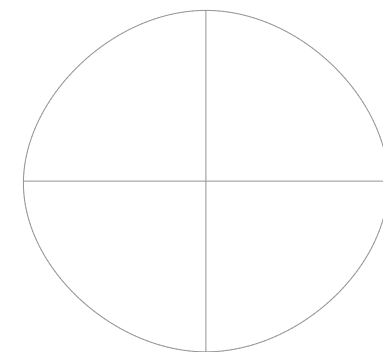
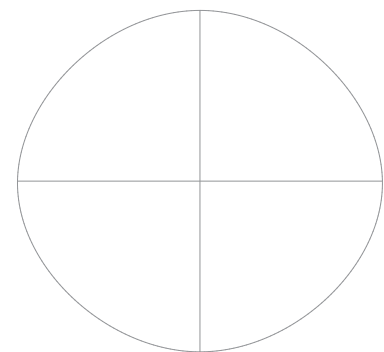
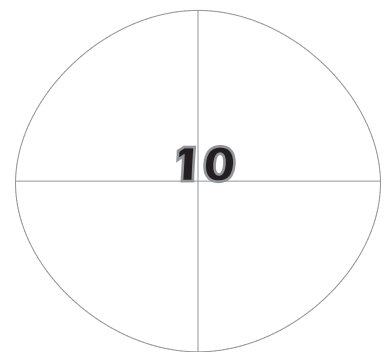
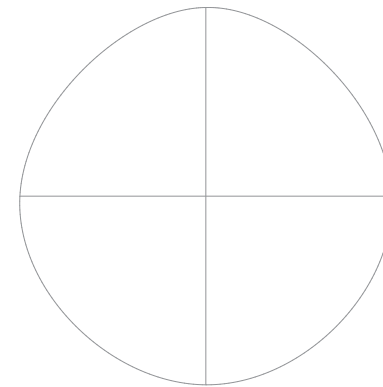
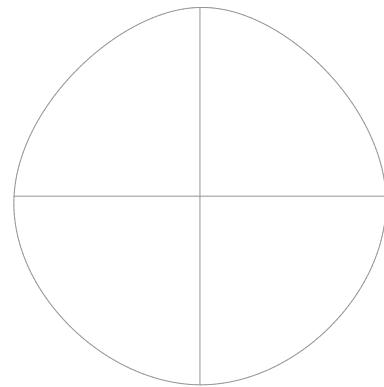
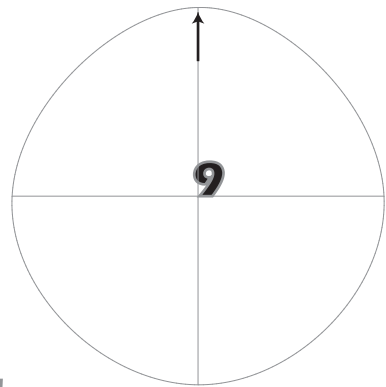
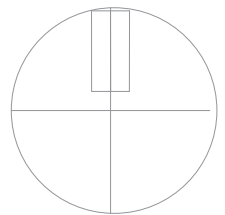
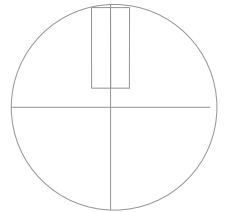
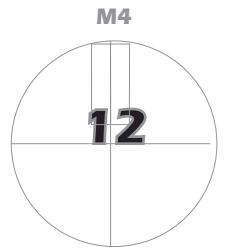
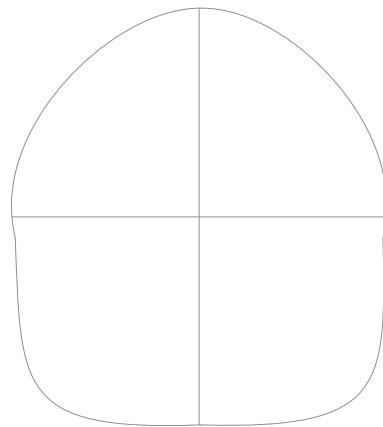
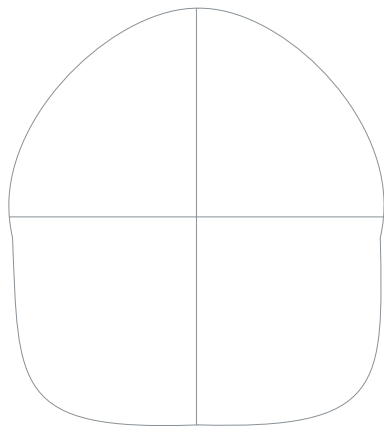
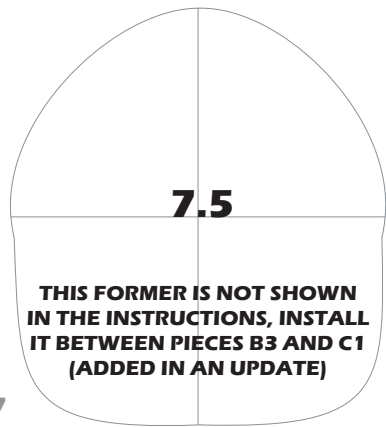

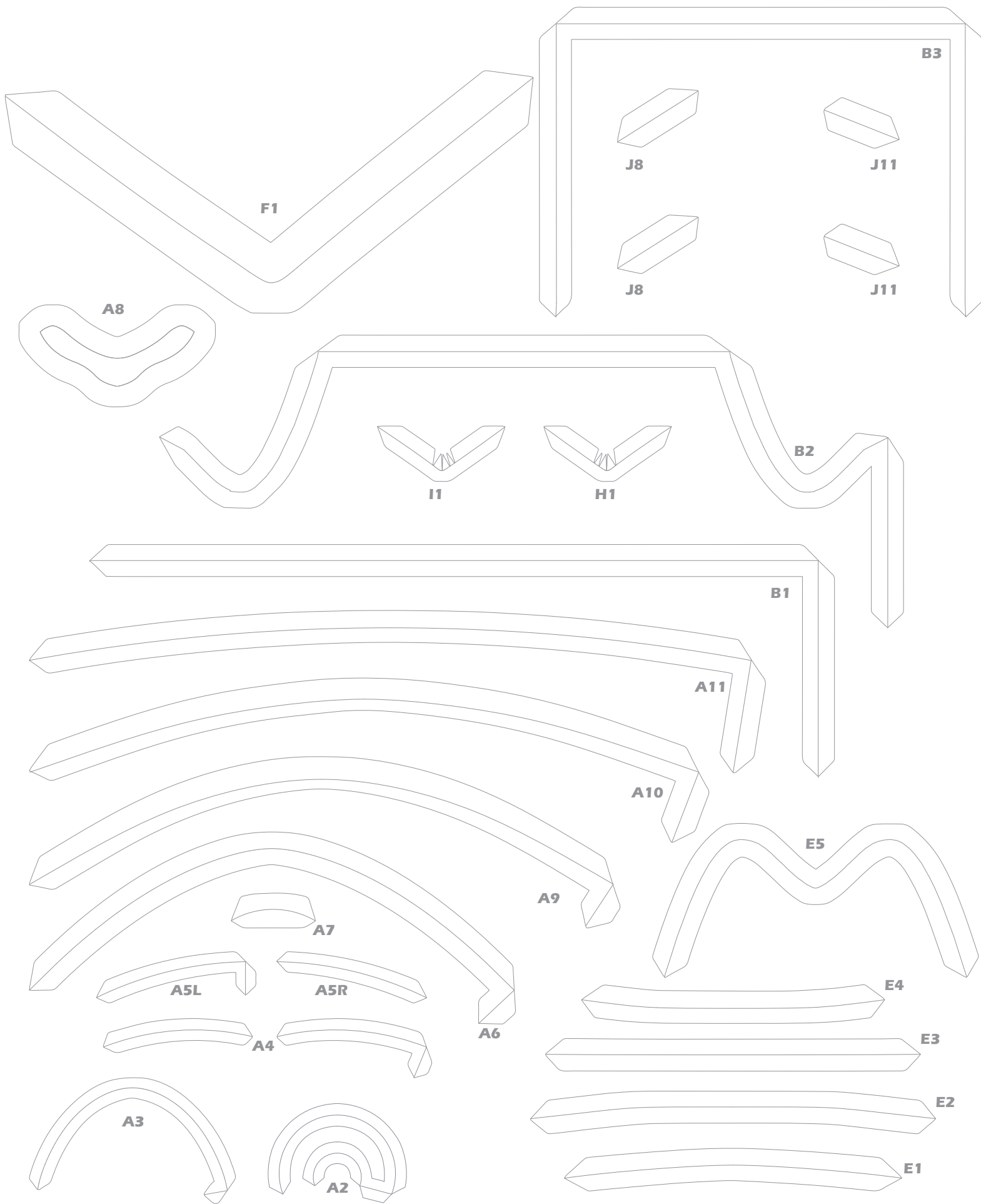

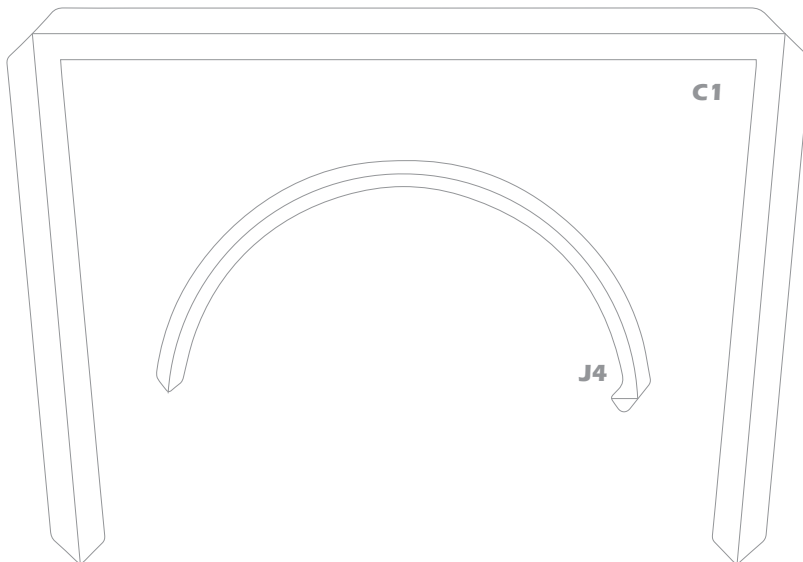
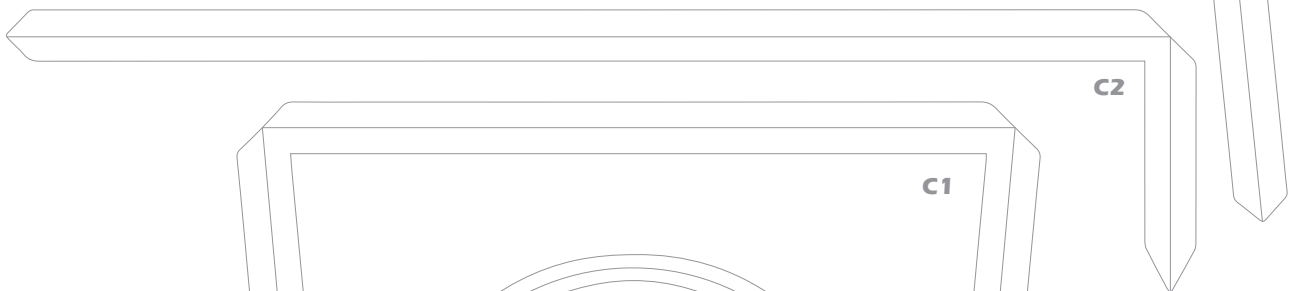
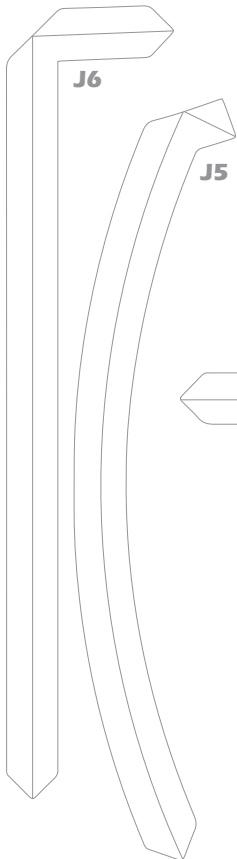
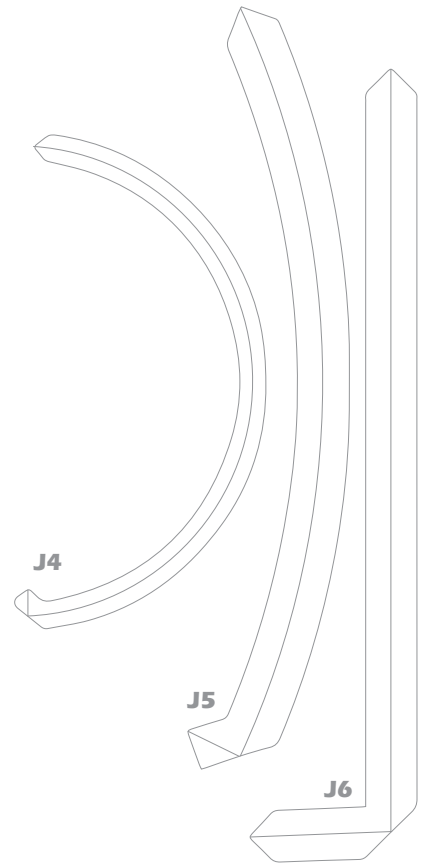
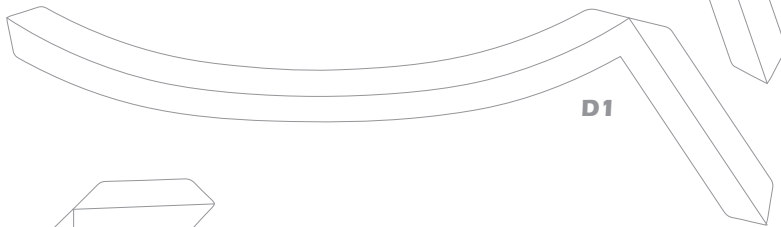
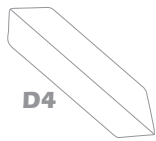
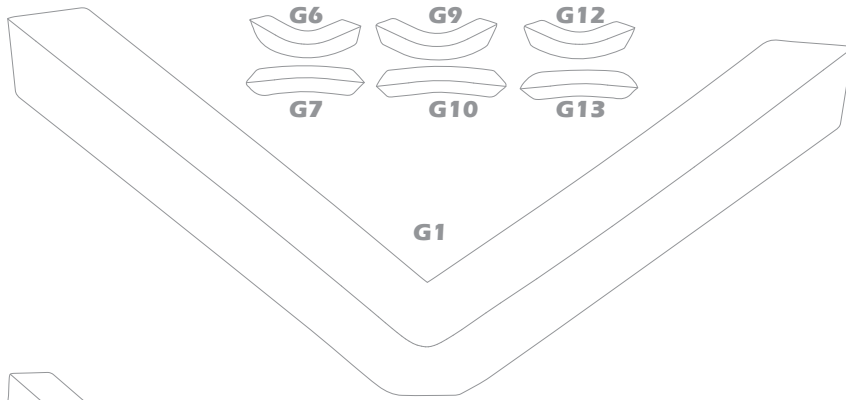
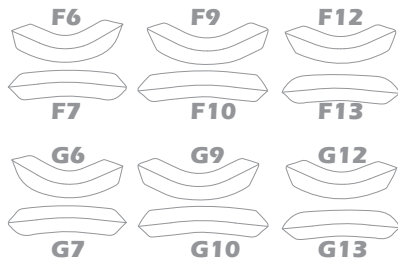

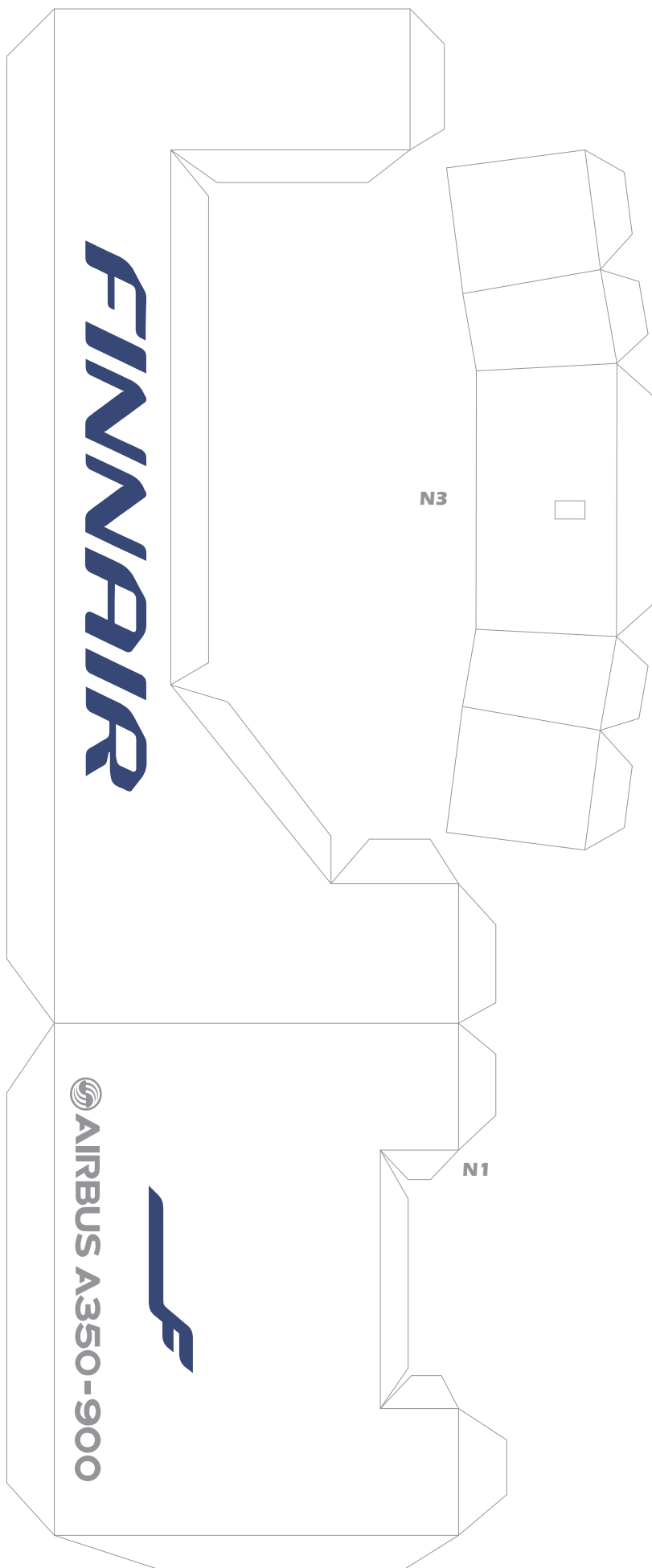

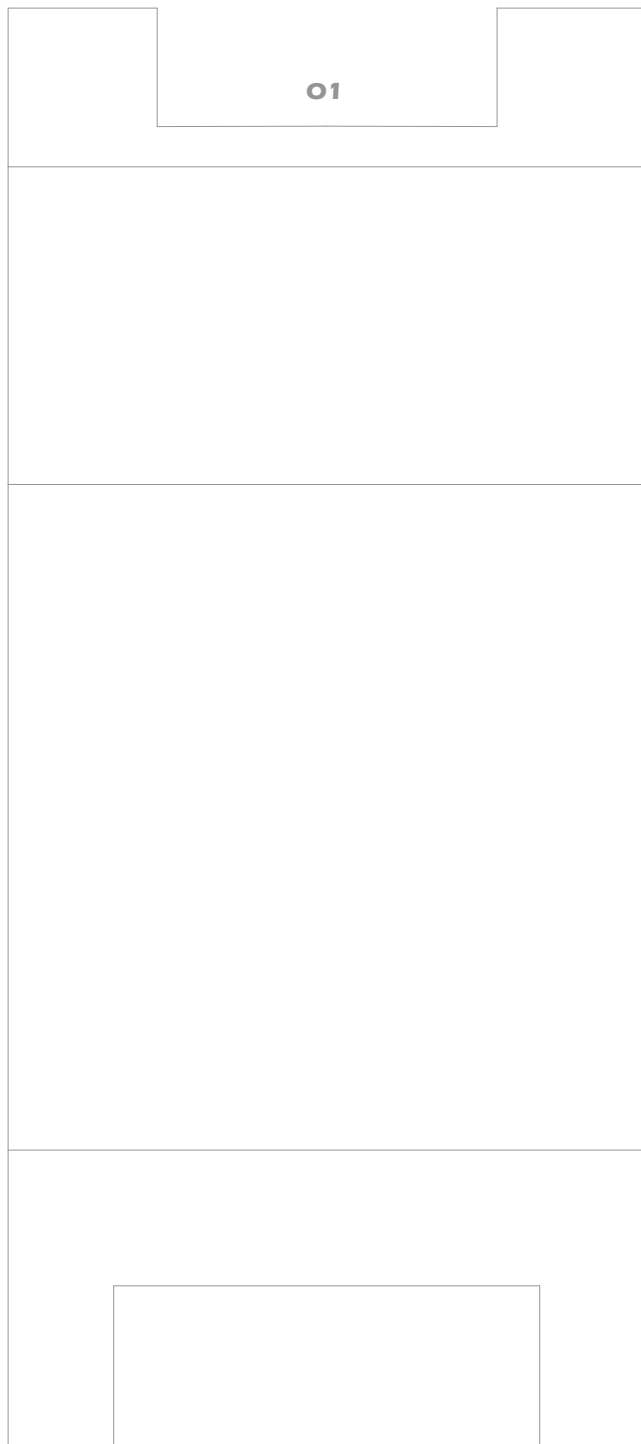
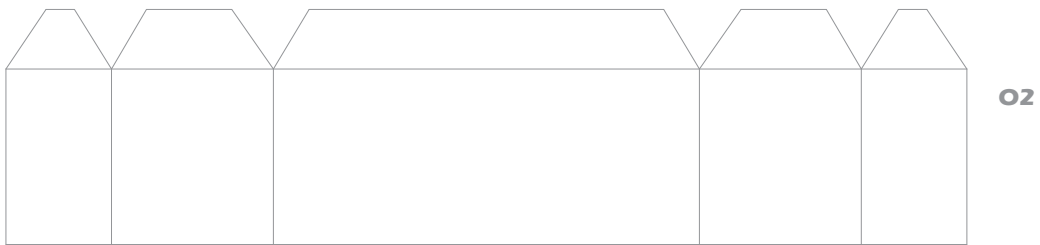

O3

ORIGINAL MODEL DESIGNED BY EDWIN RODRIGUEZ

HERMERCRAFT

PLEASE DO NOT SELL THIS FILE | DESIGNED IN PALMARES, COSTA RICA