

Blank space for 787-10 variant

Instructions



Scan

A14

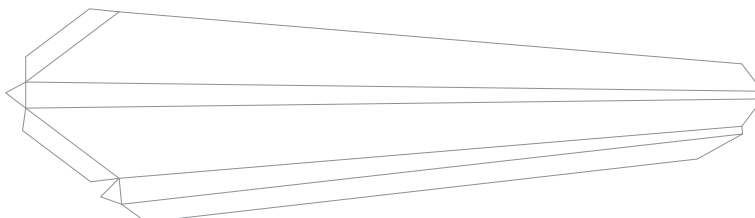

A16L

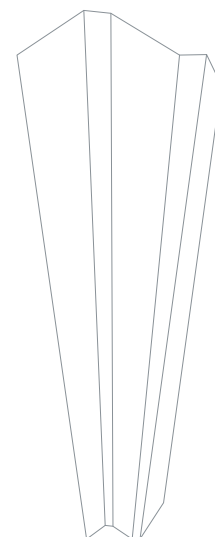

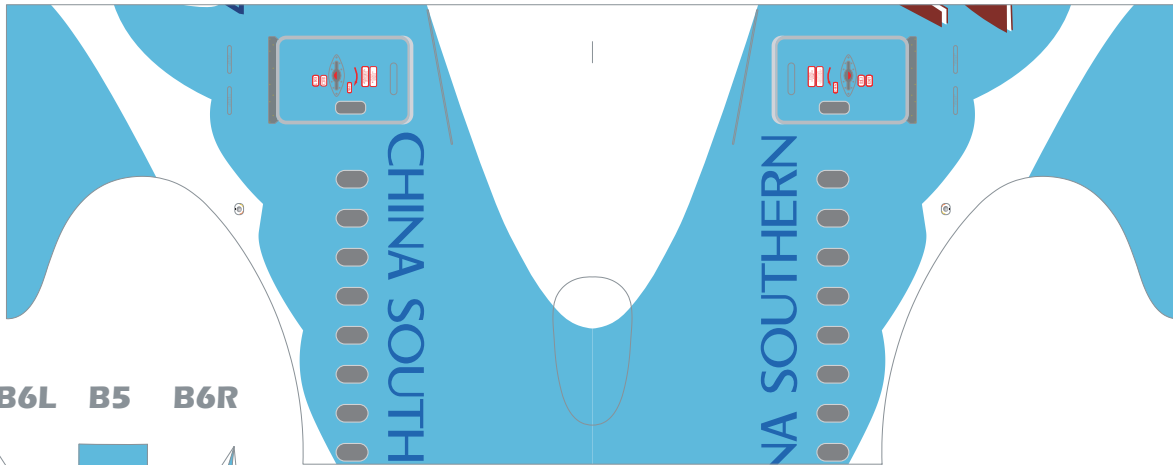

B6L B5 B6R

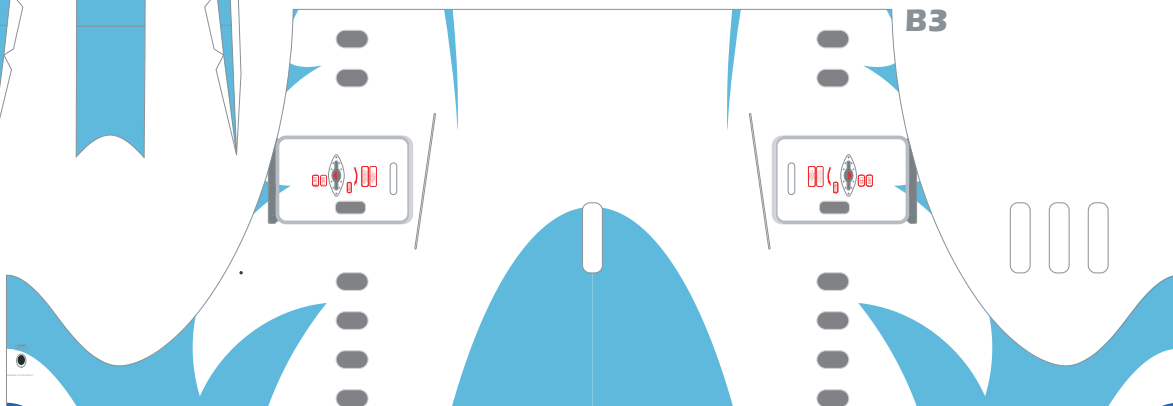
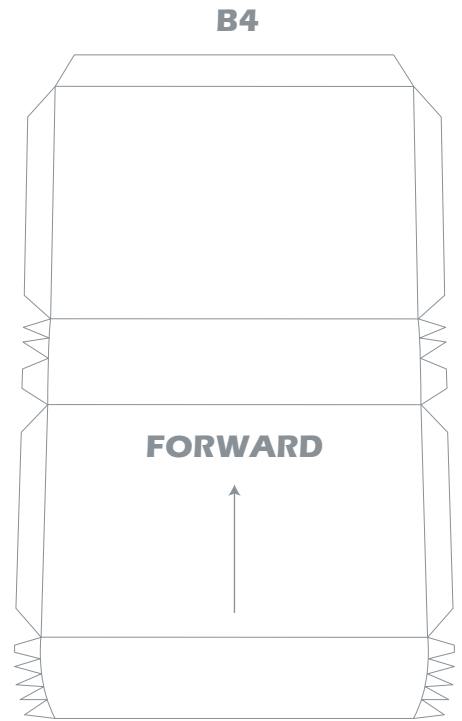
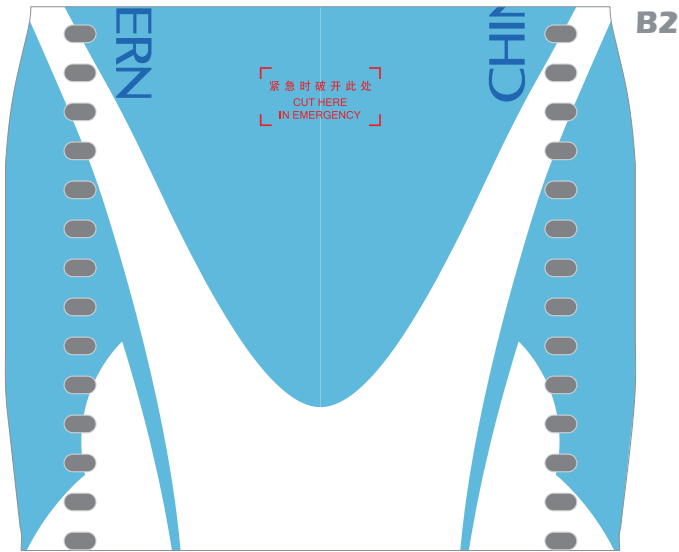
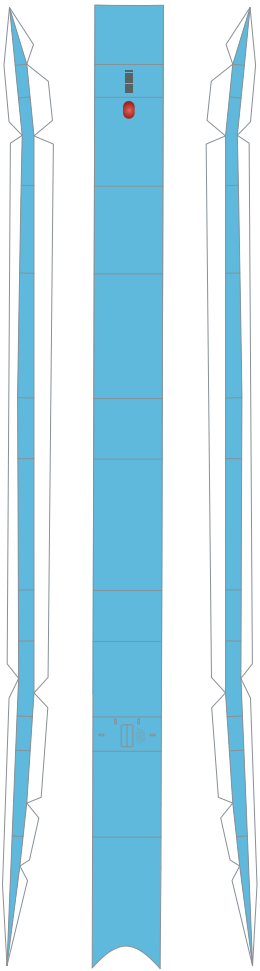

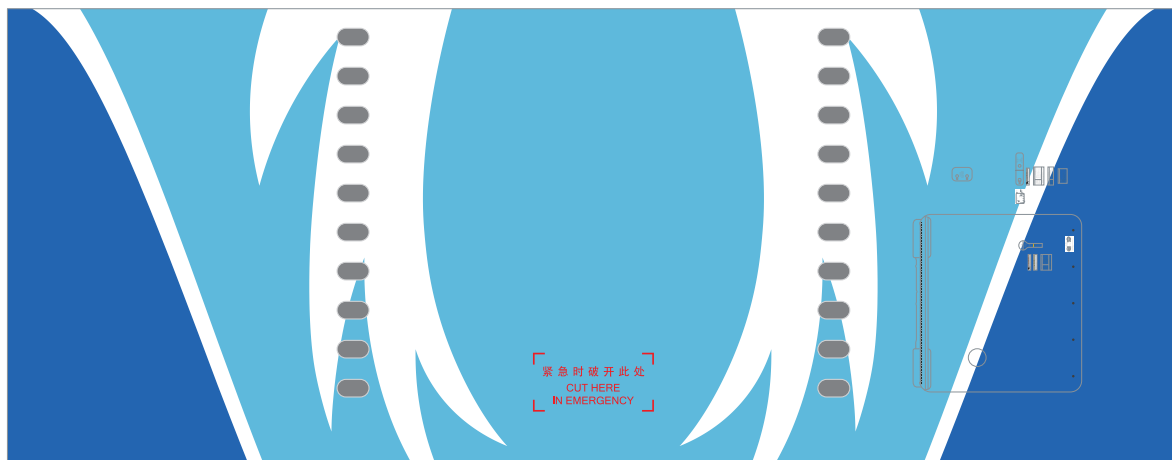

Blank space for 787-10 variant

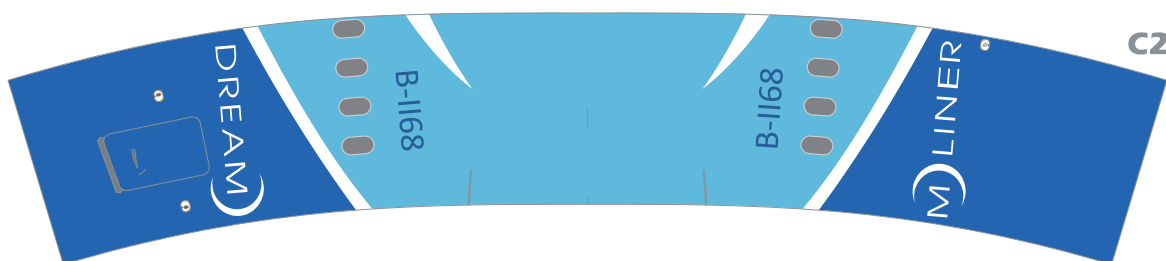
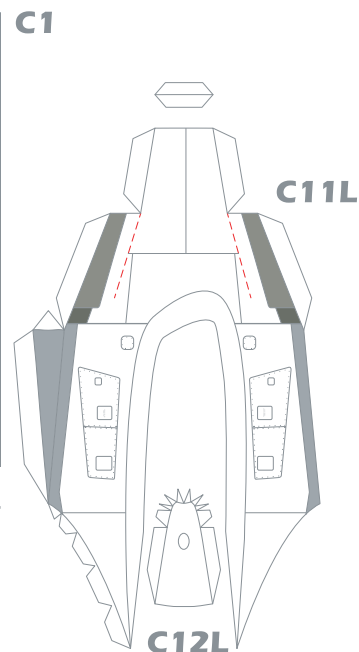

C2

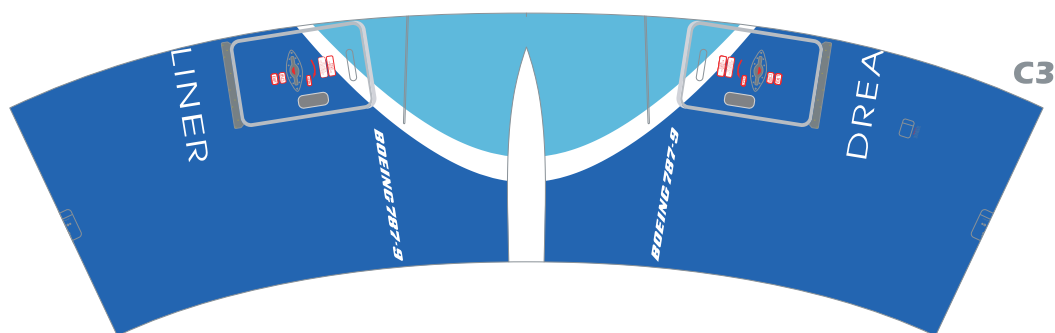
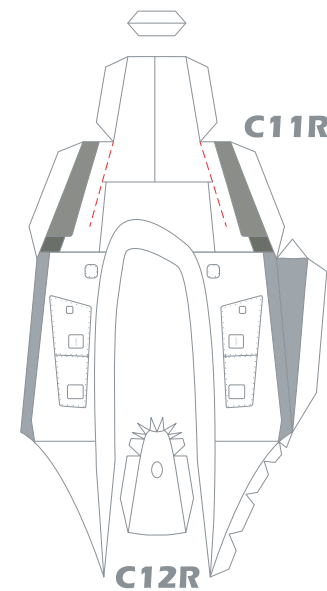

C3

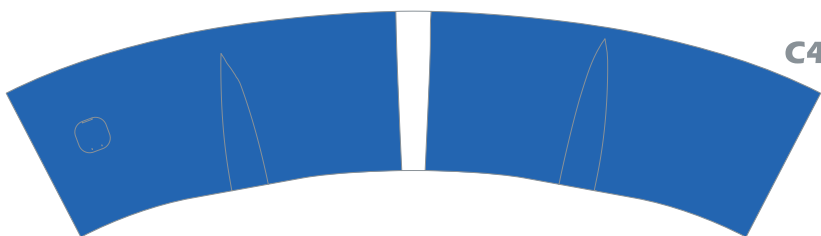

C4

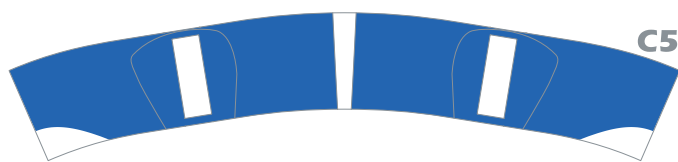

C5



C10L



C10R



C8



C9

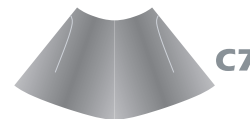

C7

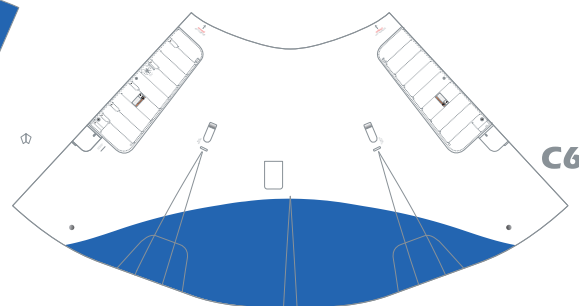

C6



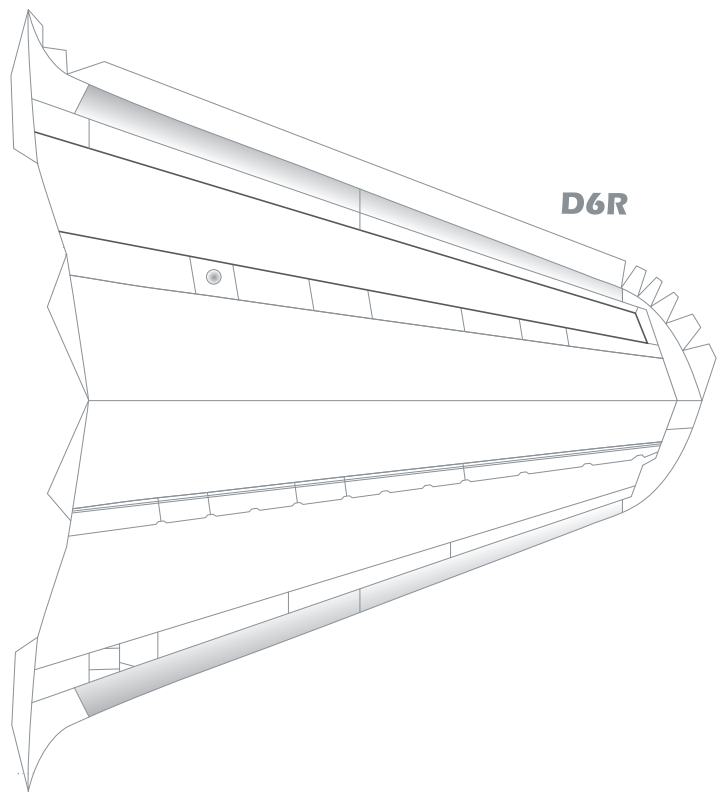
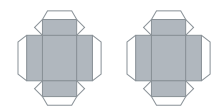
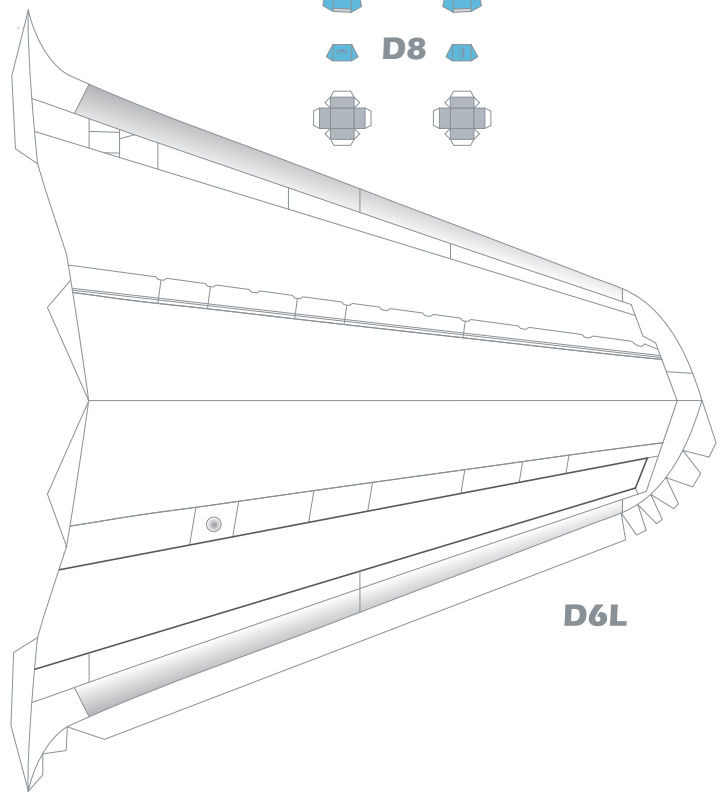
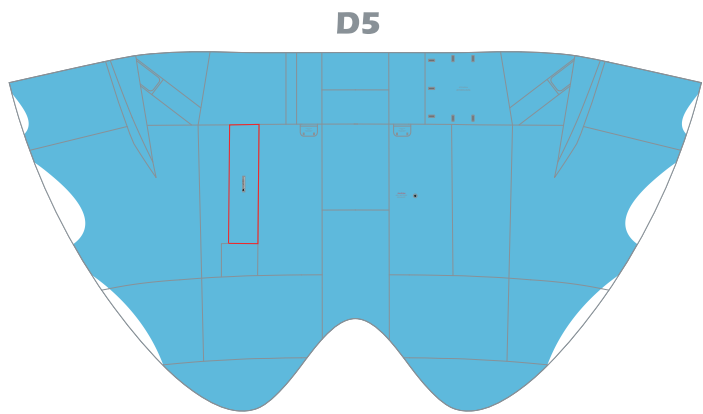
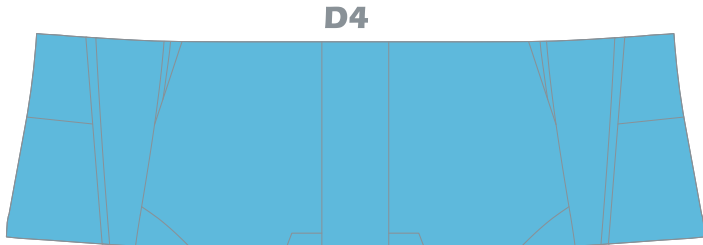
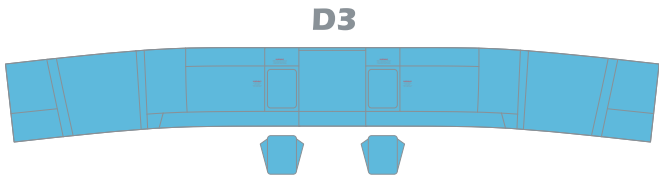
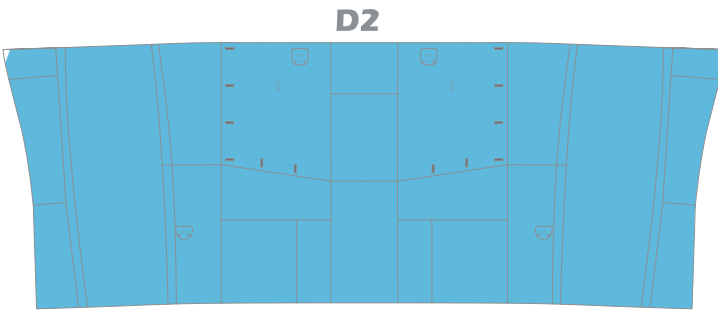
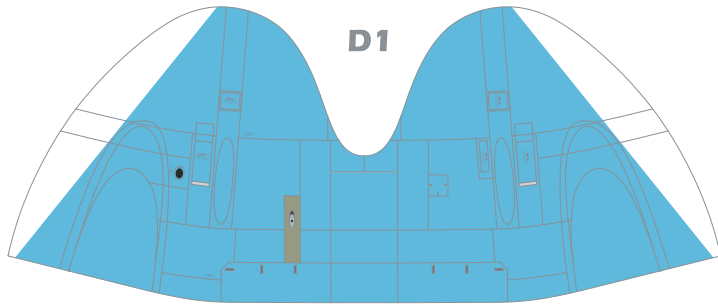

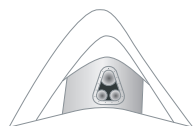

E2L

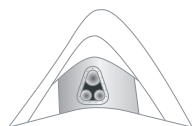

E2R

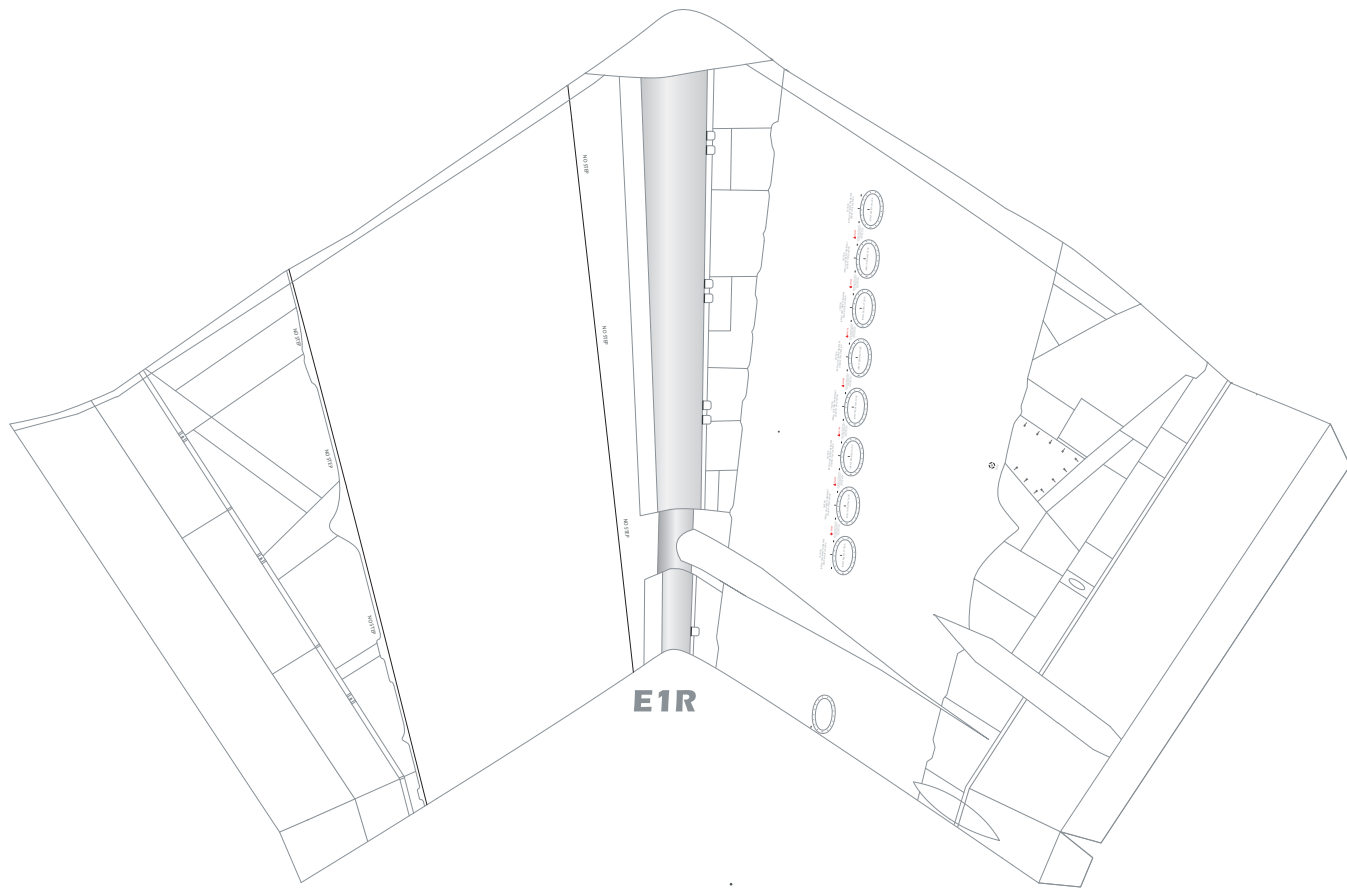
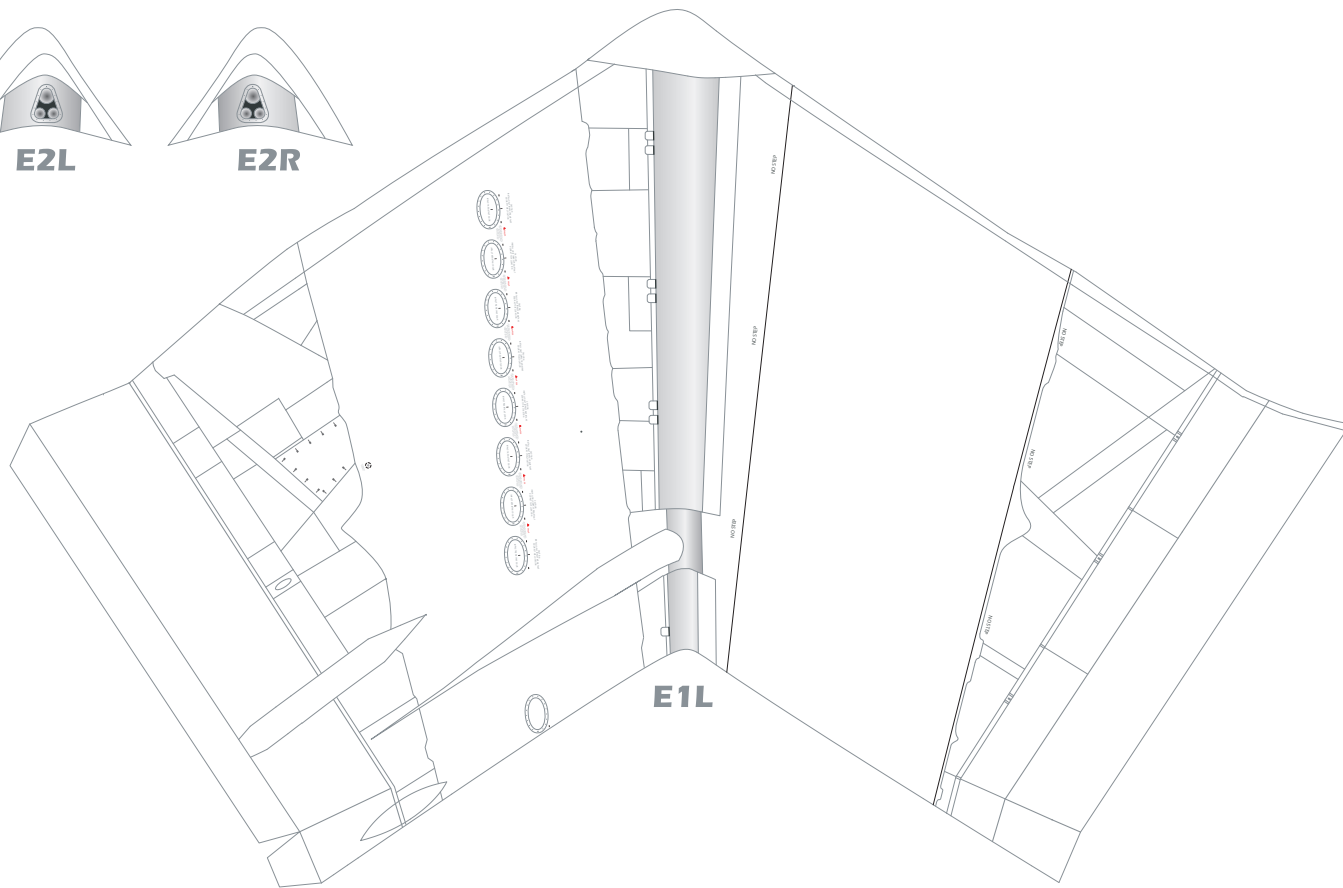

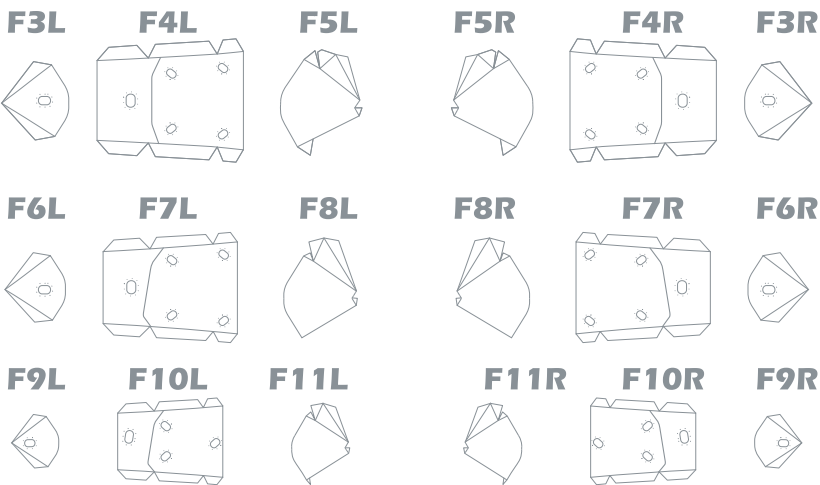
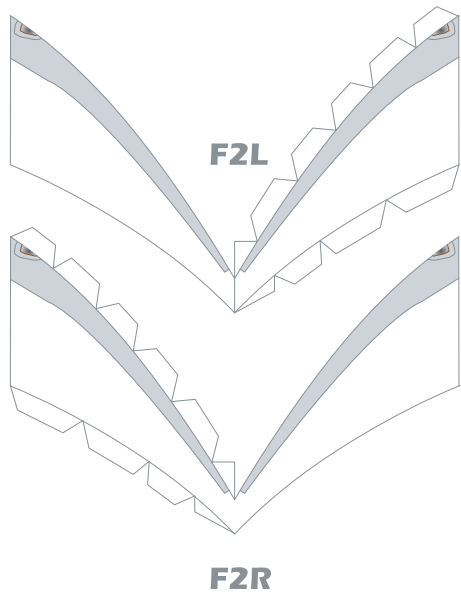
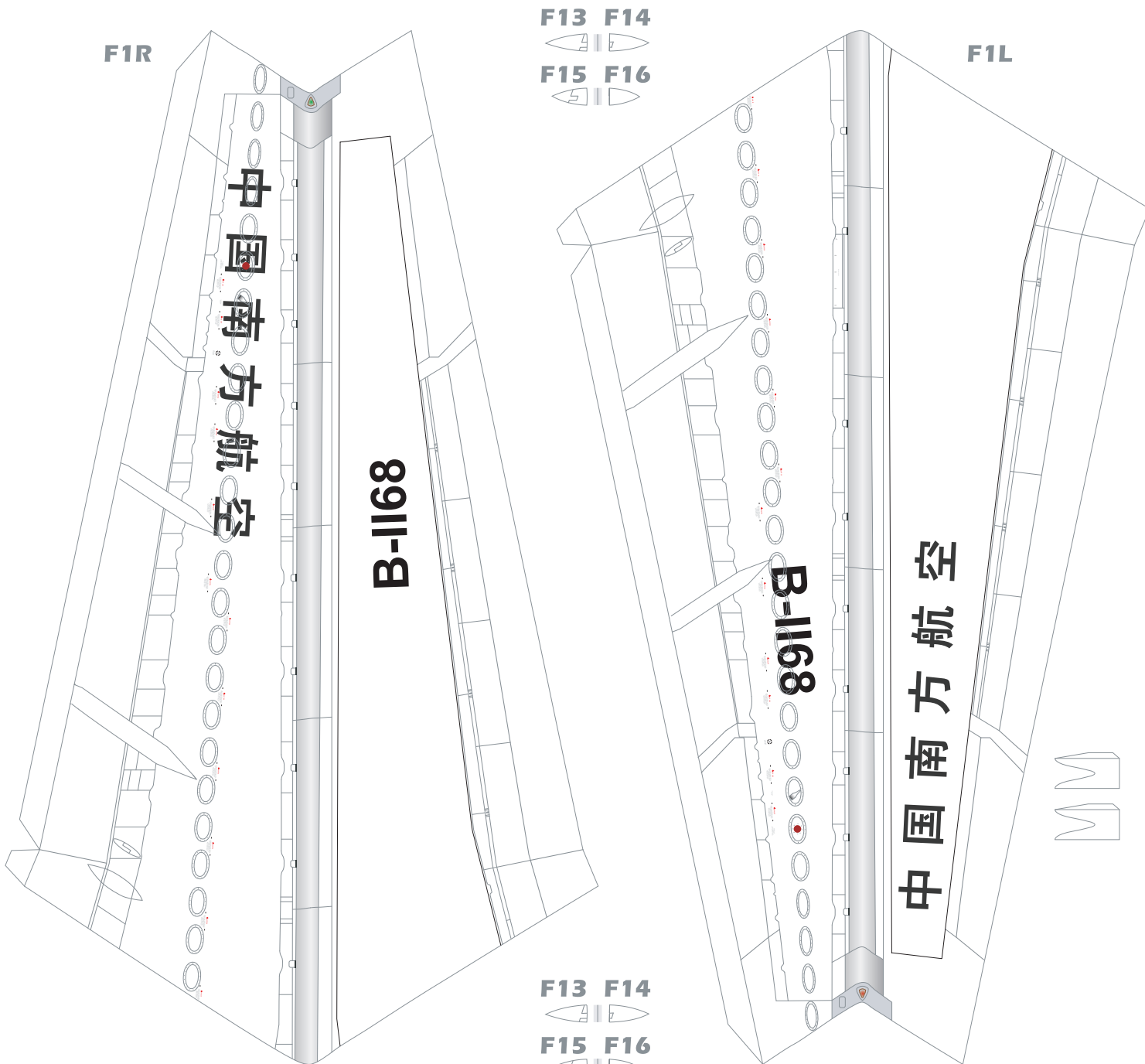

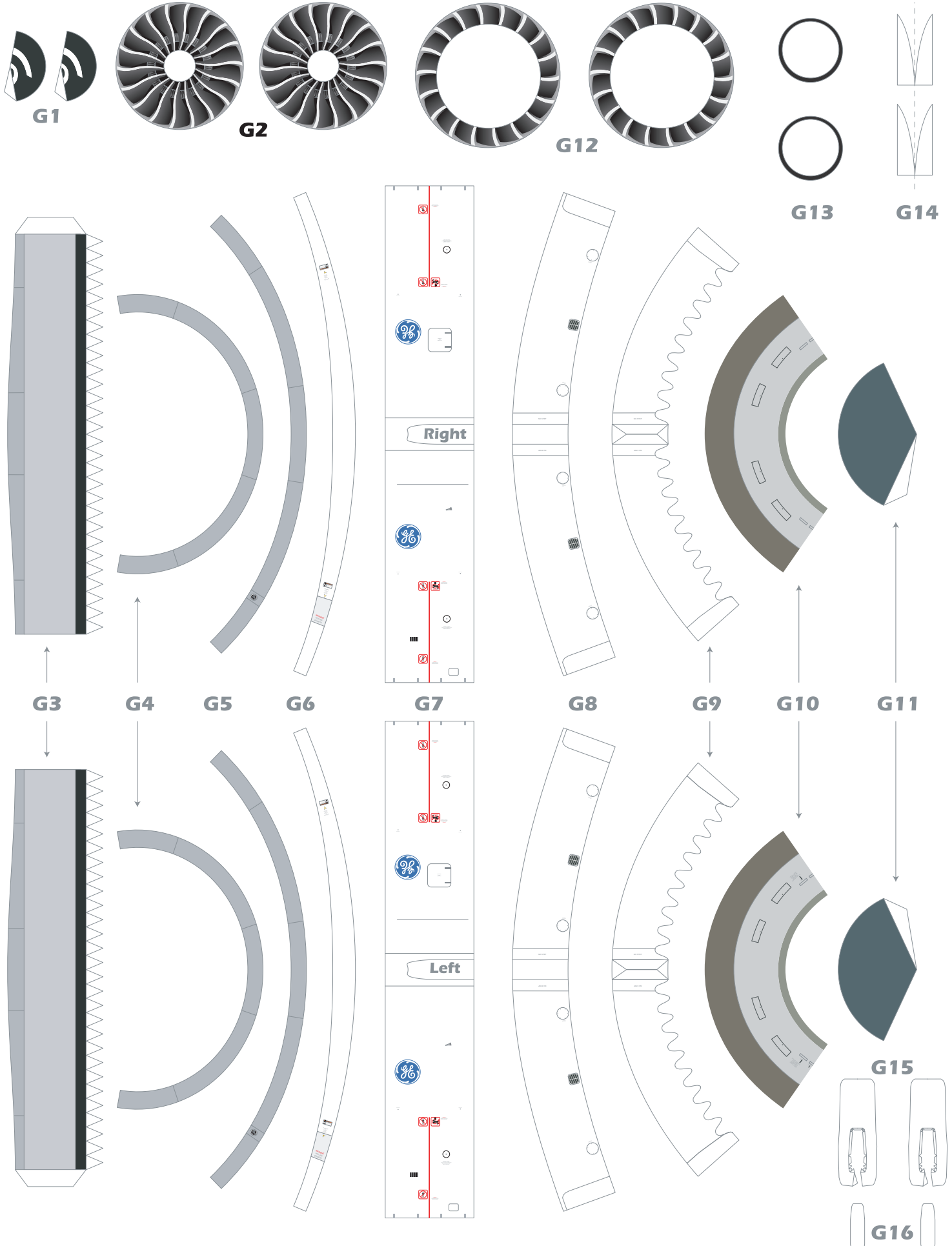

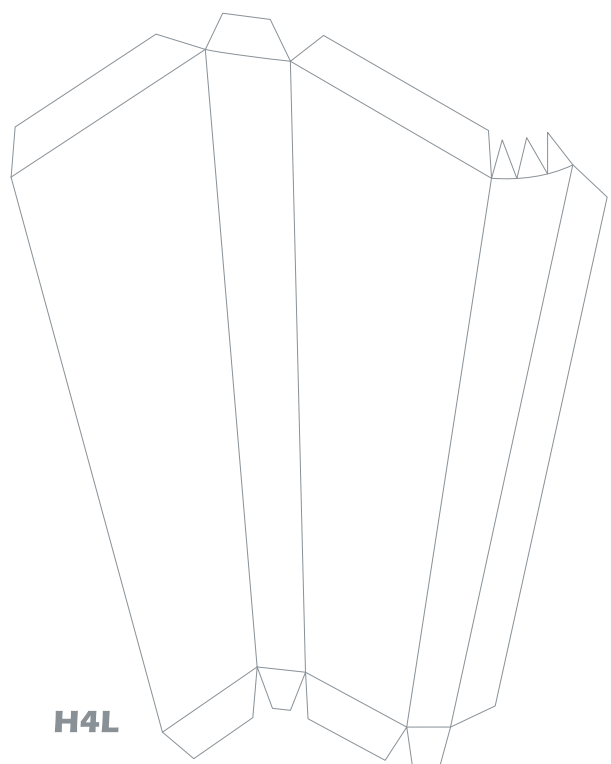
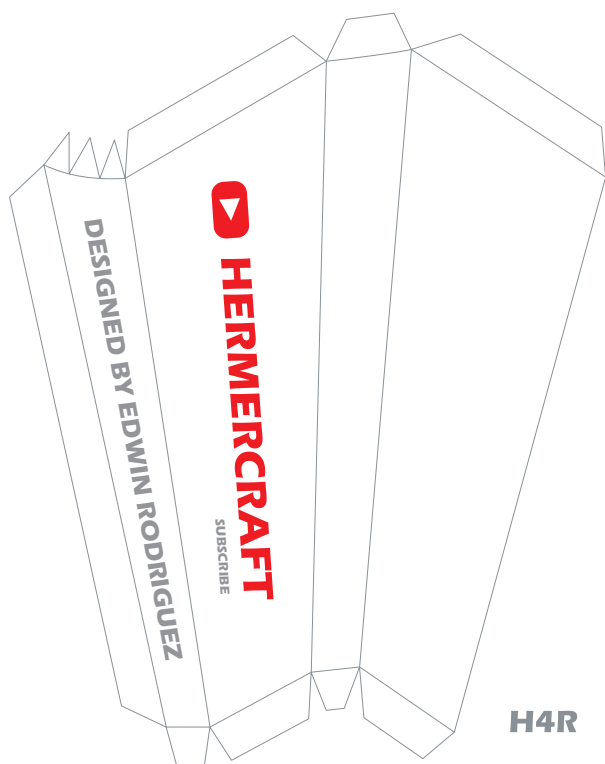
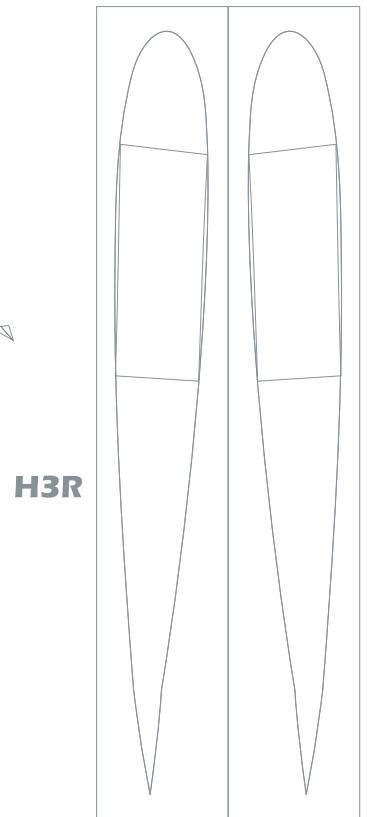
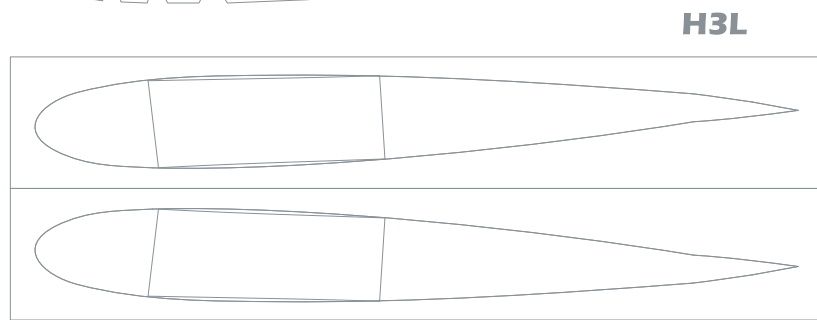
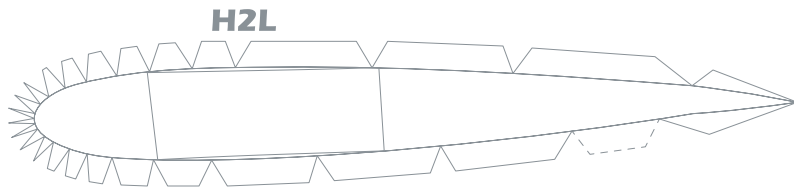
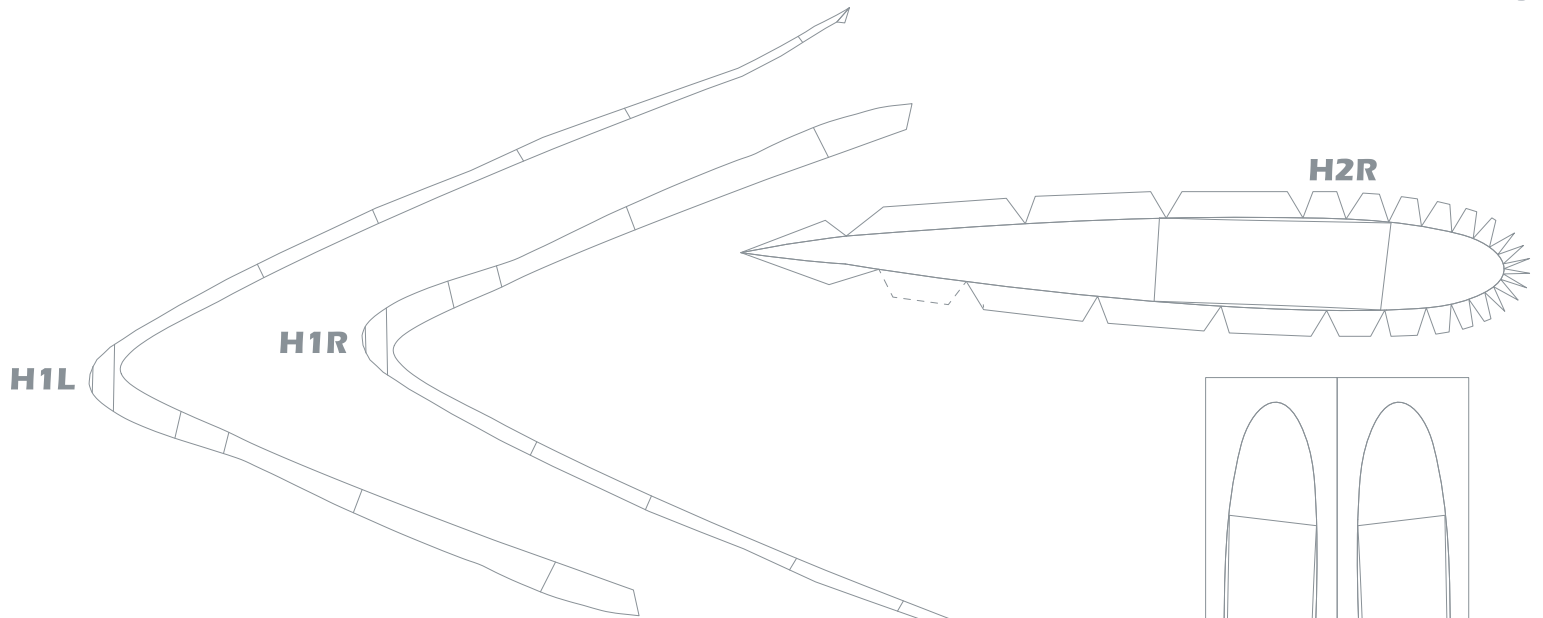



Repainted by: Kedy Zhou + Mingzhi Wang

© 2021 Edwin Rodriguez

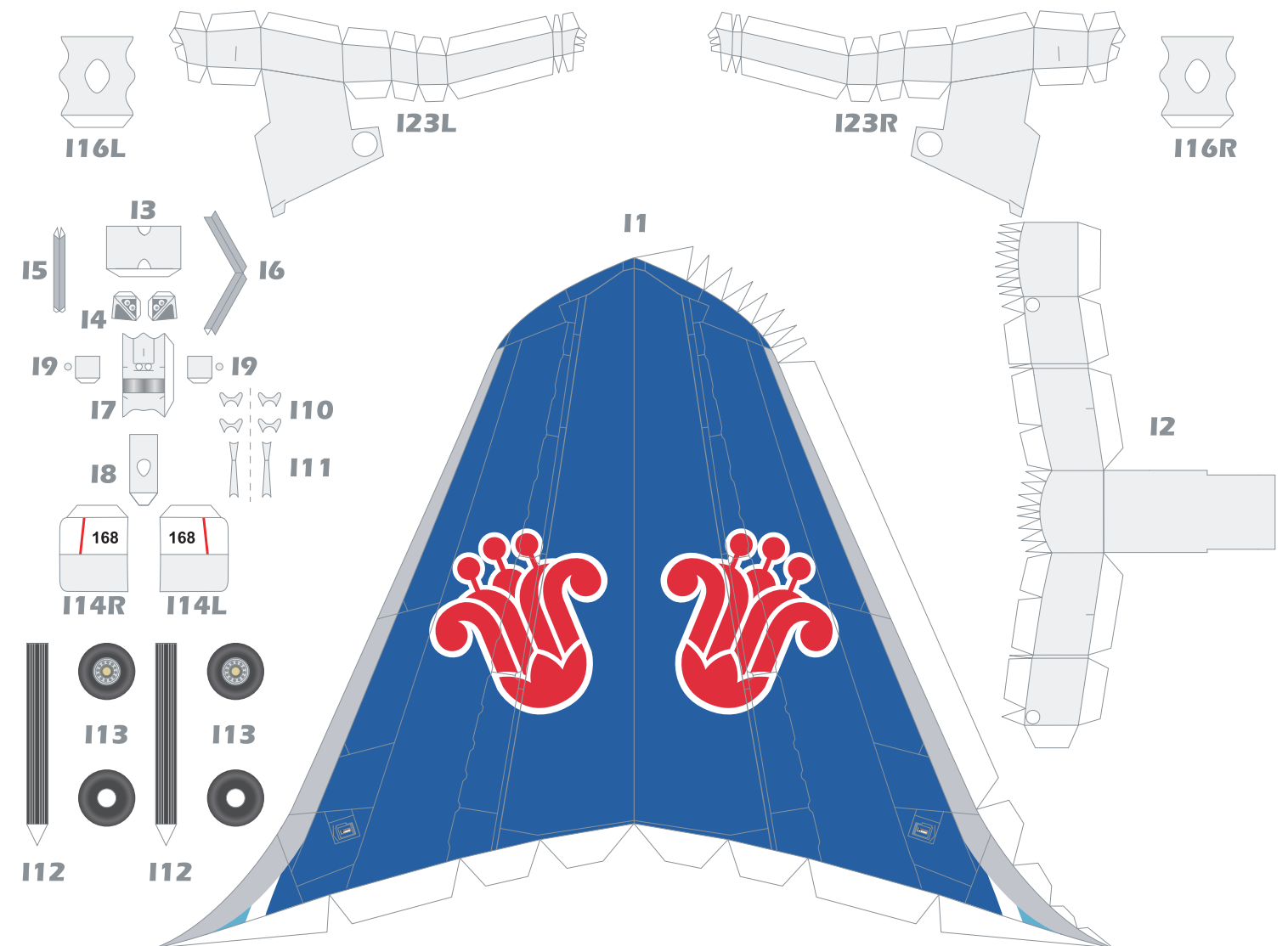
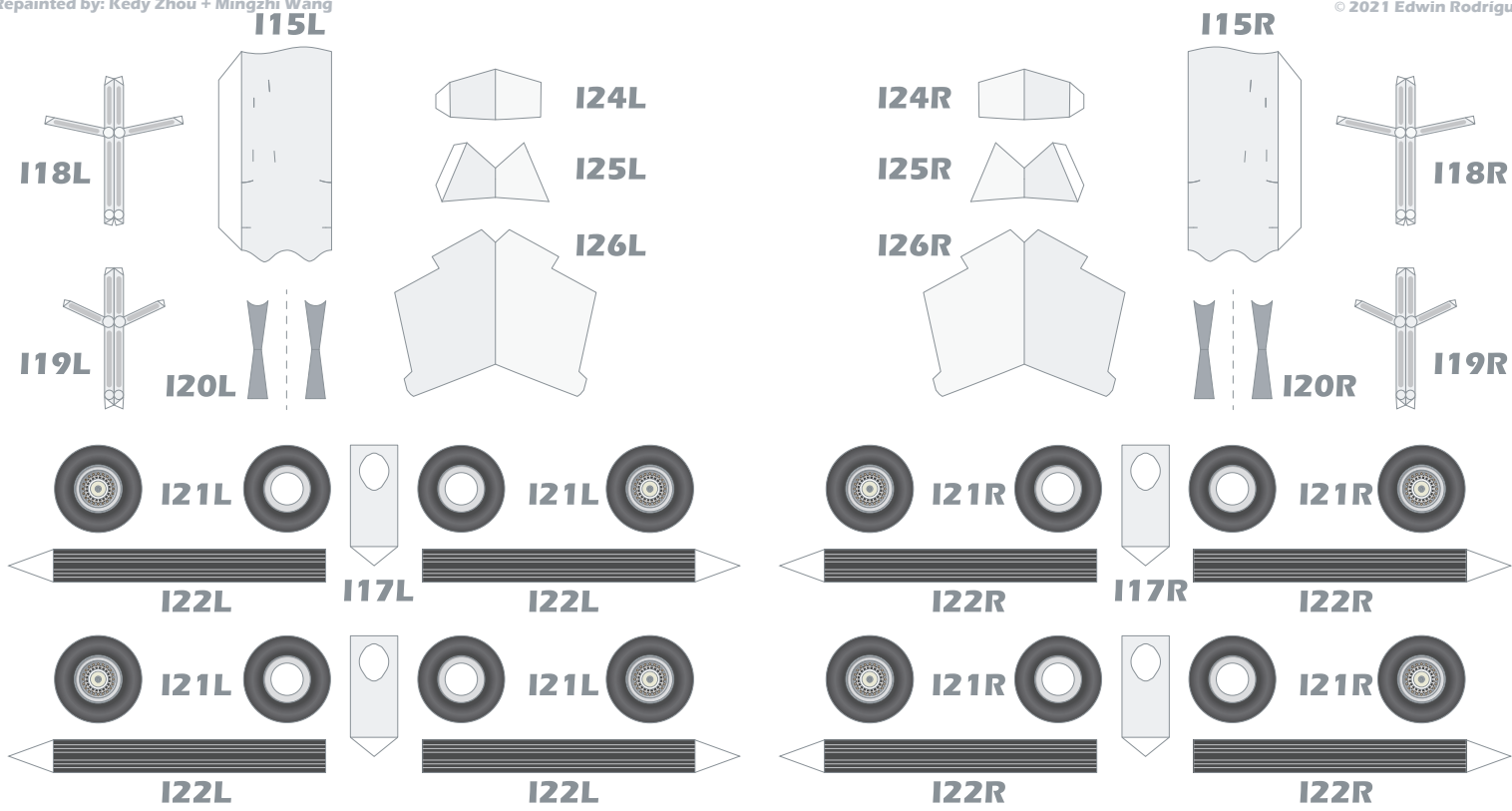

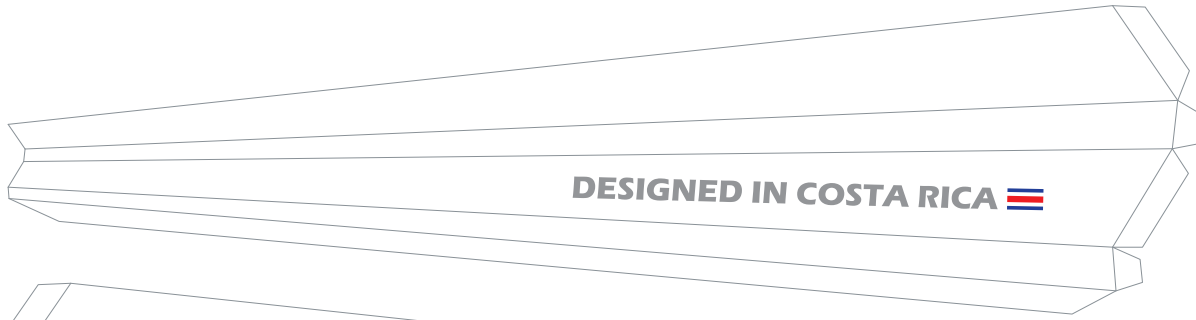

J1L

DESIGNED IN COSTA RICA 



J1R

FREE MODEL, DO NOT SELL THE FILE!!!

