

Blank space for 787-10 variant

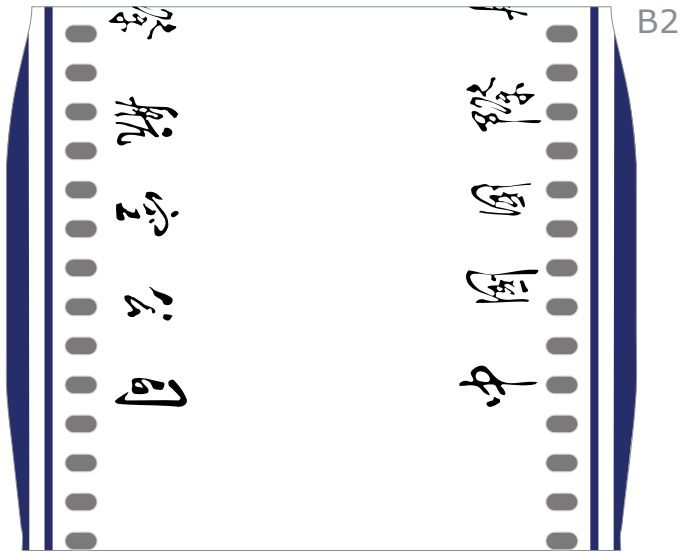

B6L B5 B6R

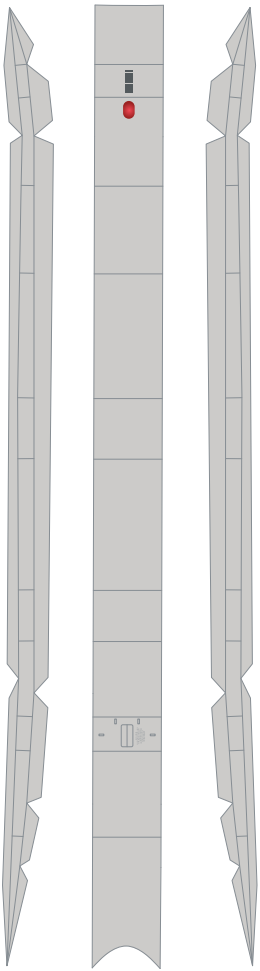

B4

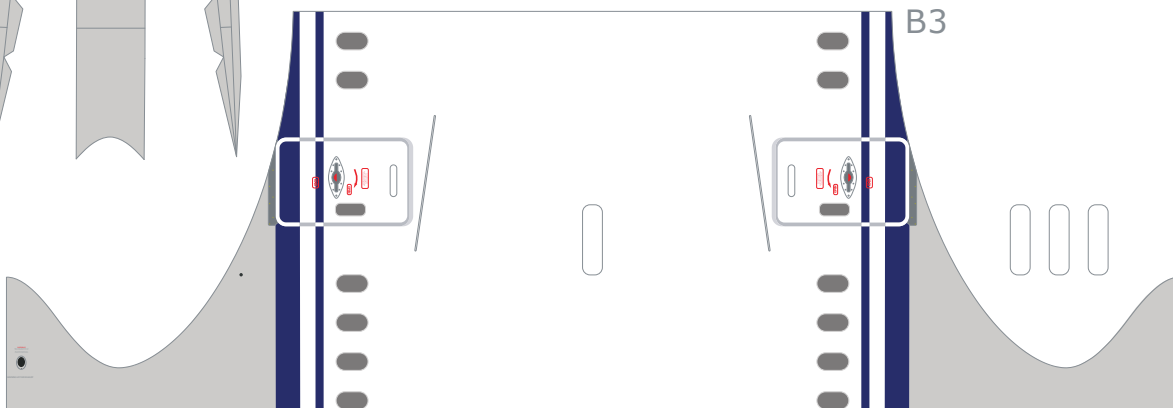
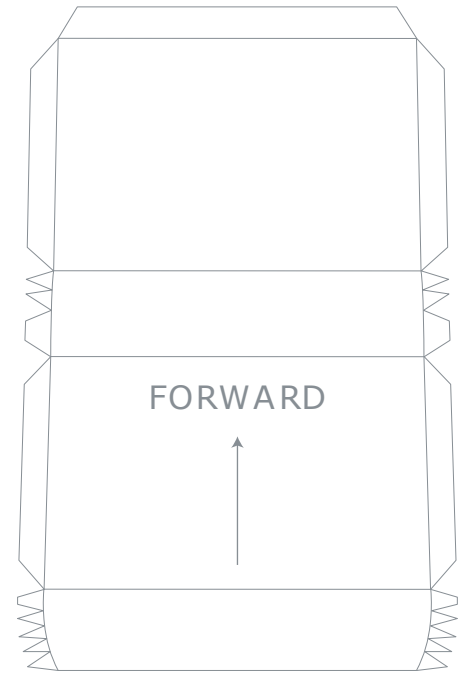

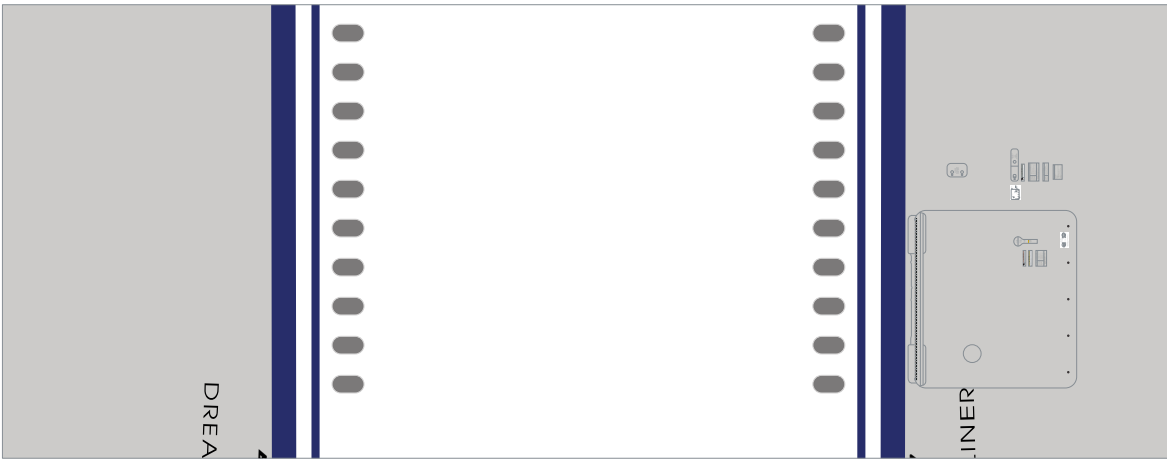

Blank space for 787-10 variant

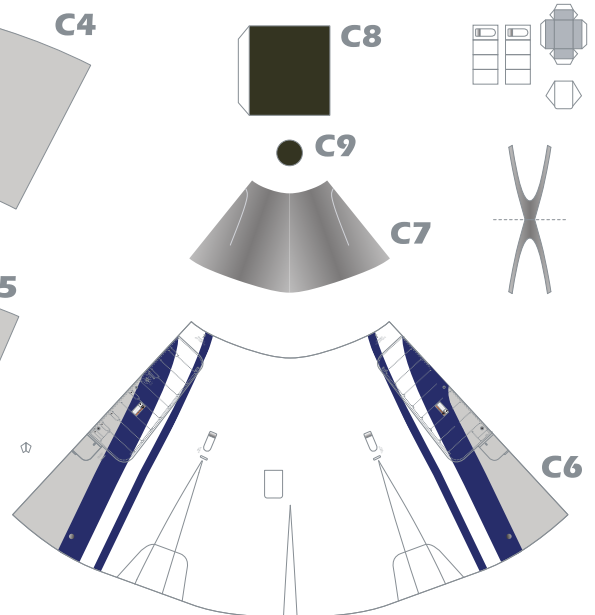
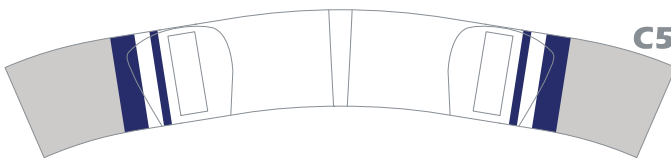
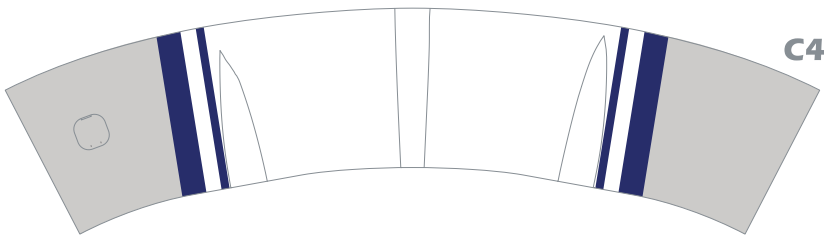
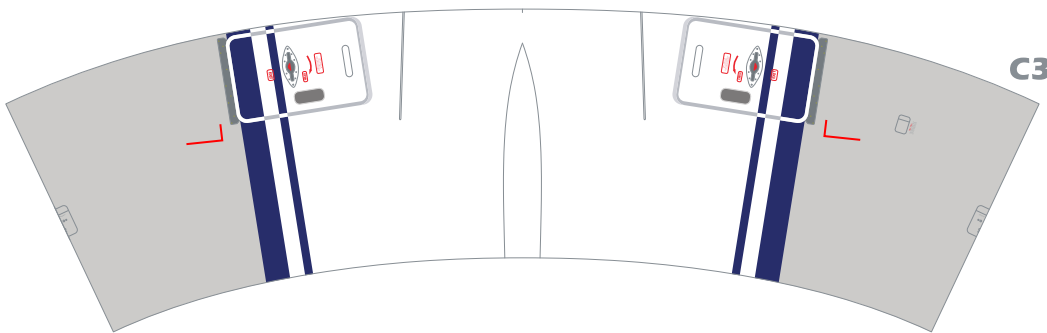
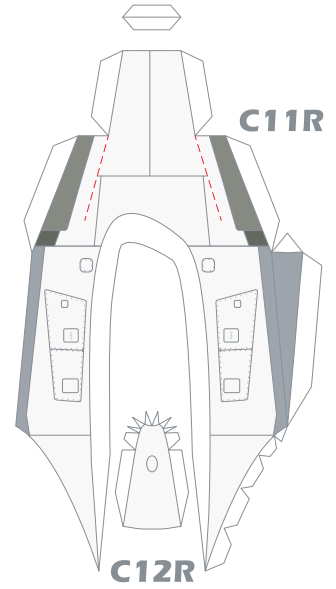
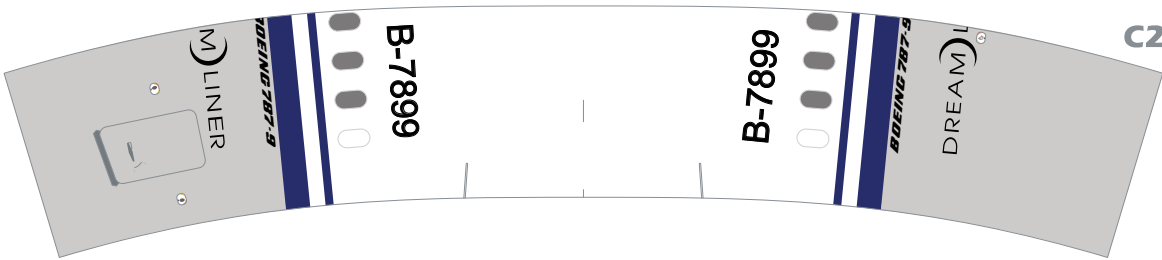
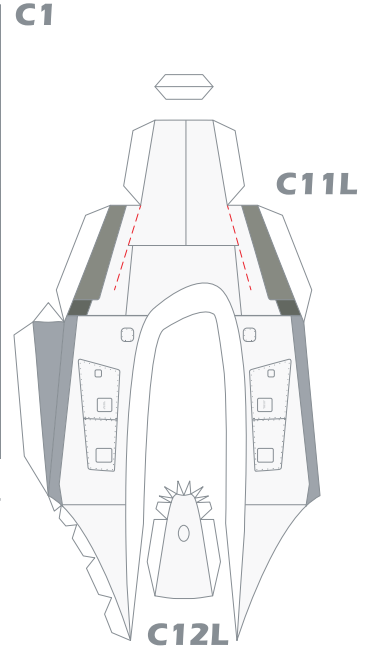

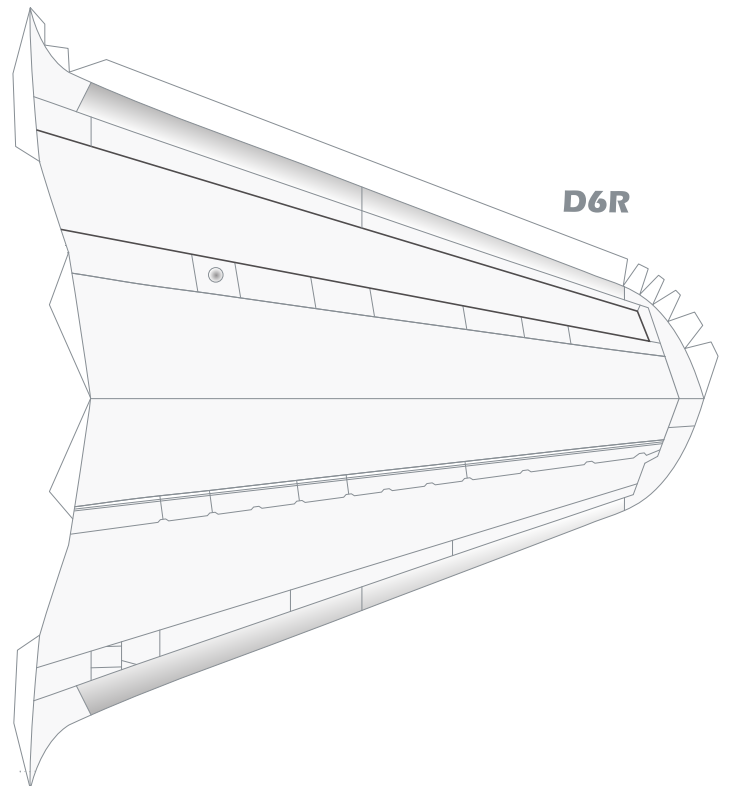
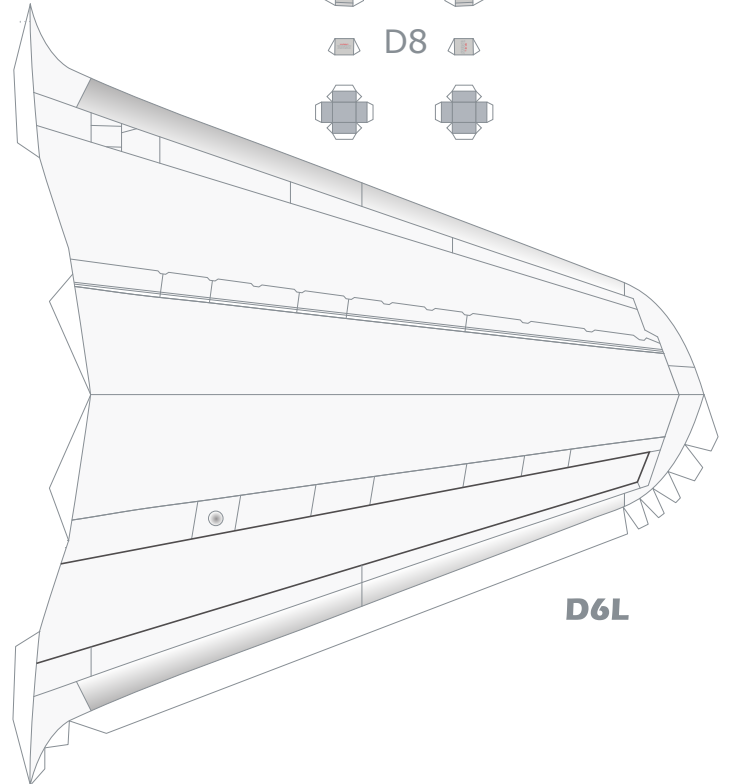
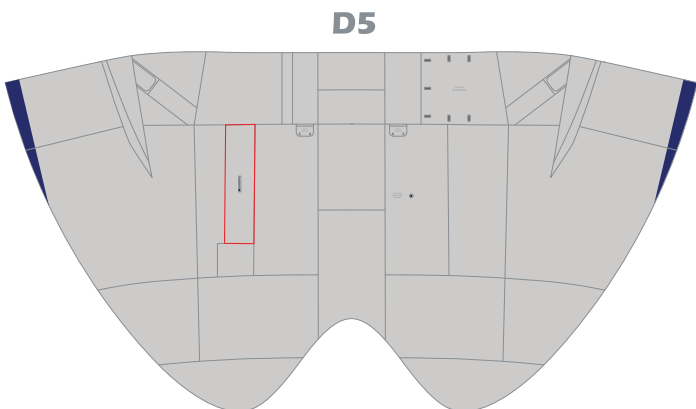
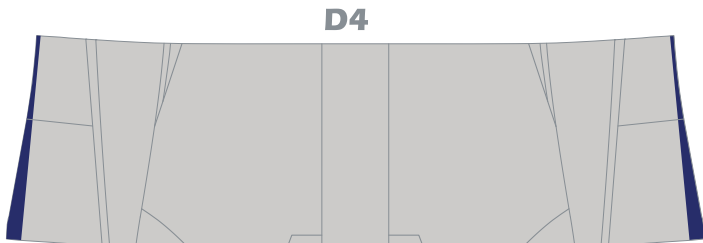
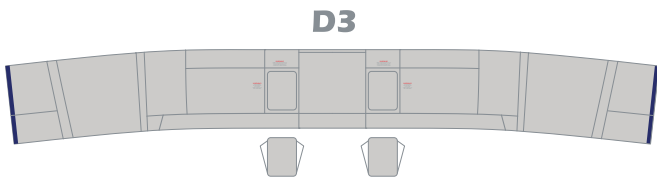
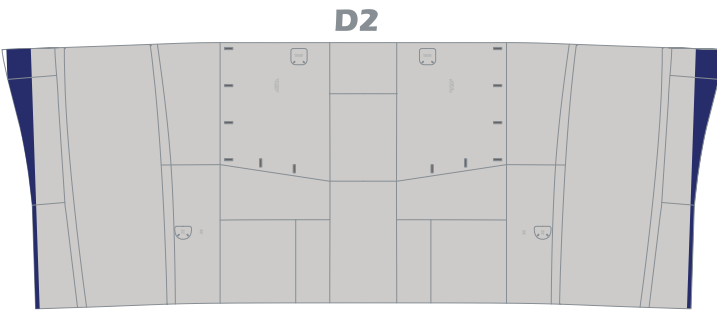
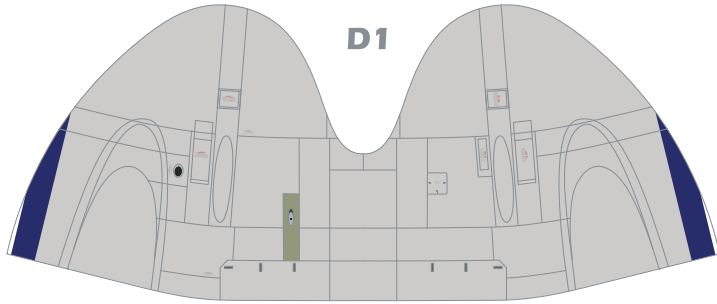

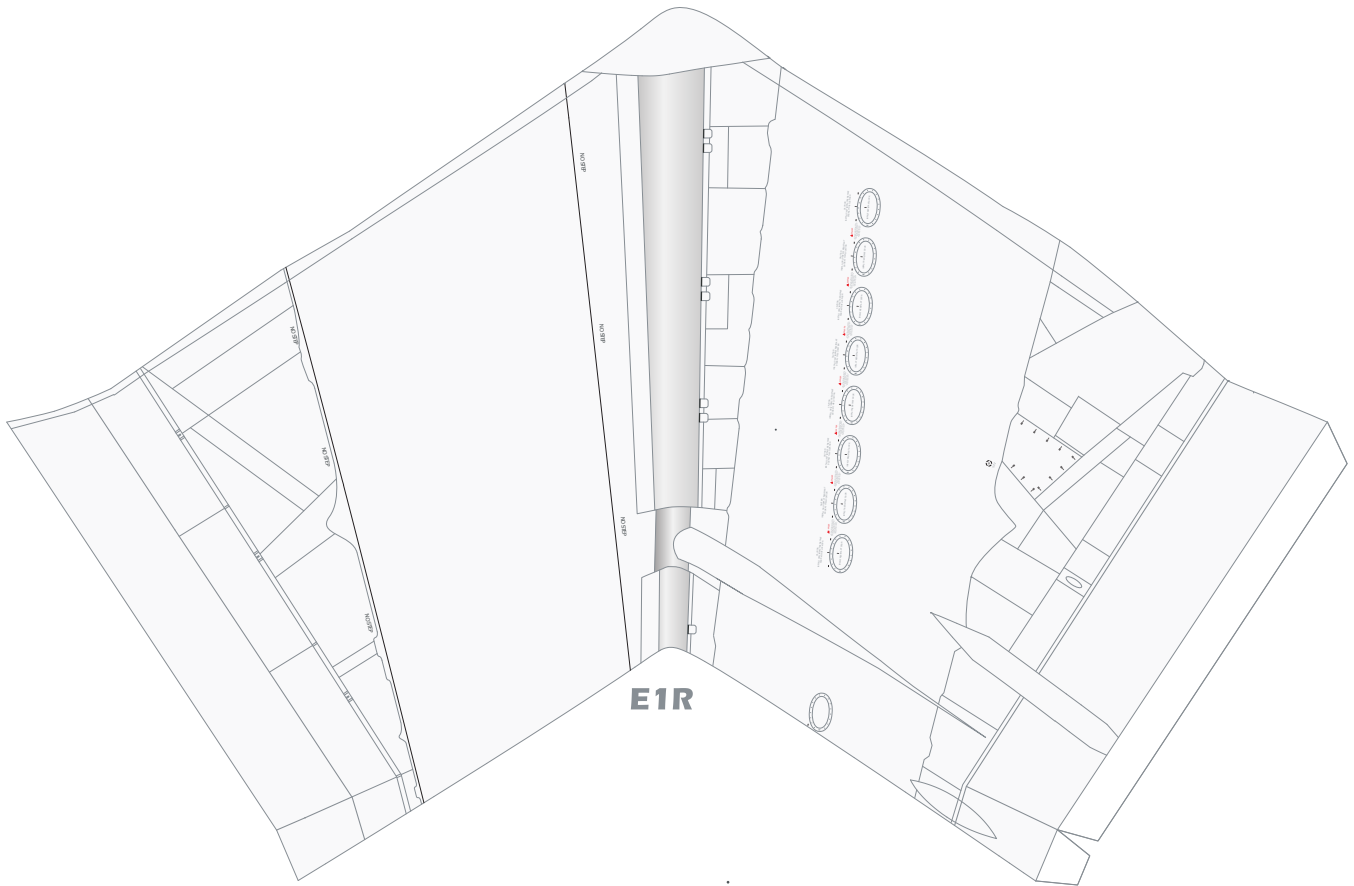
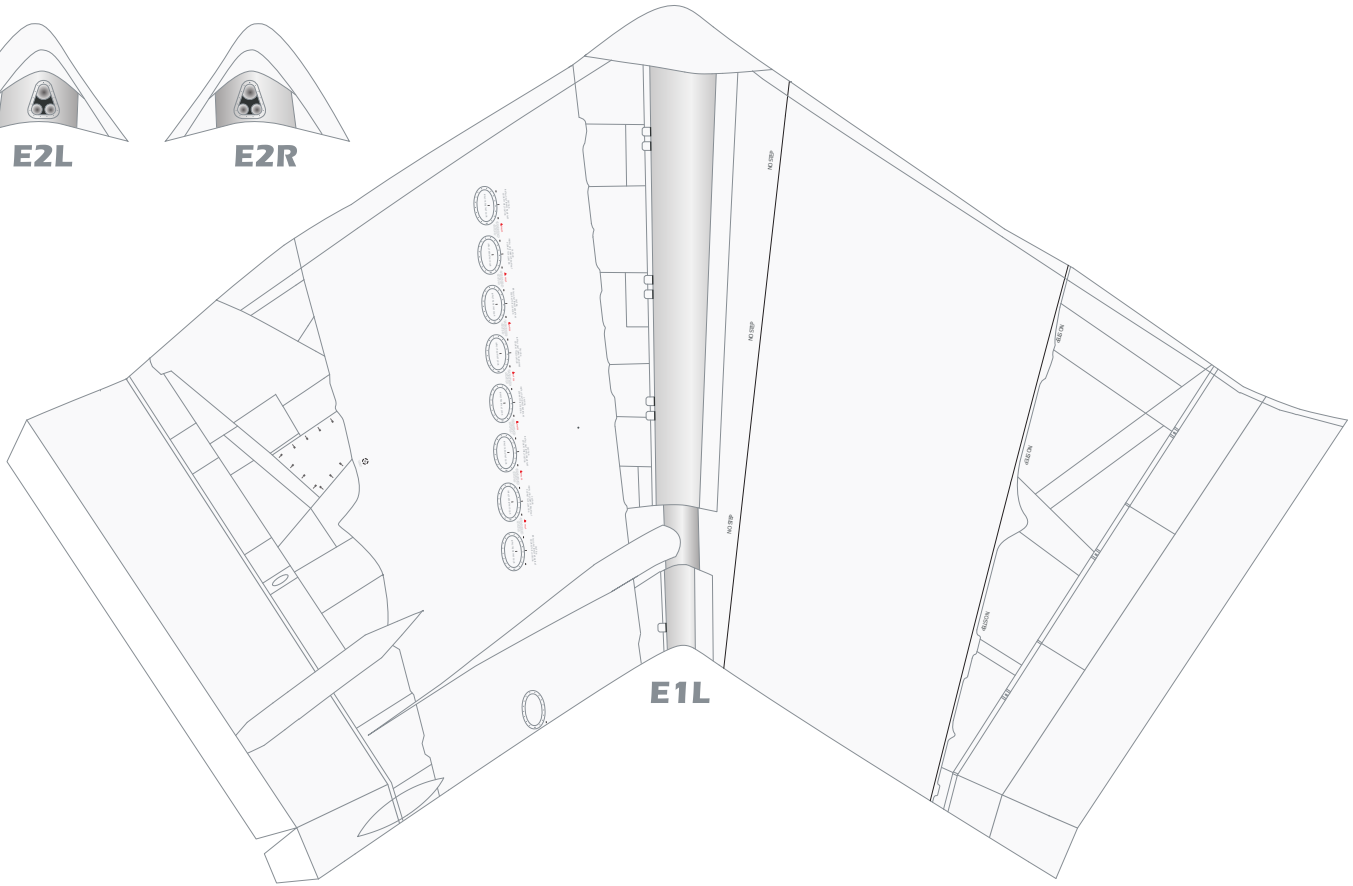



F1R

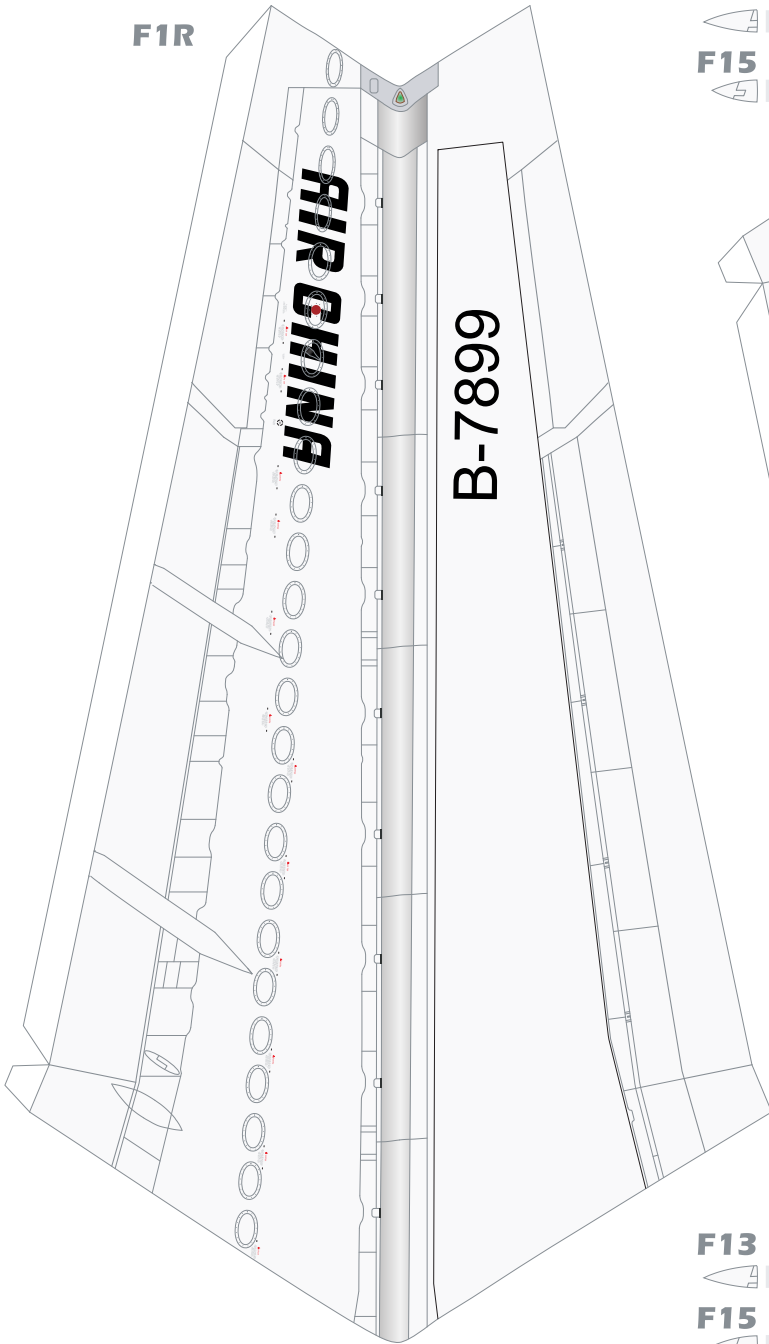

F13 F14



F15 F16



F1L

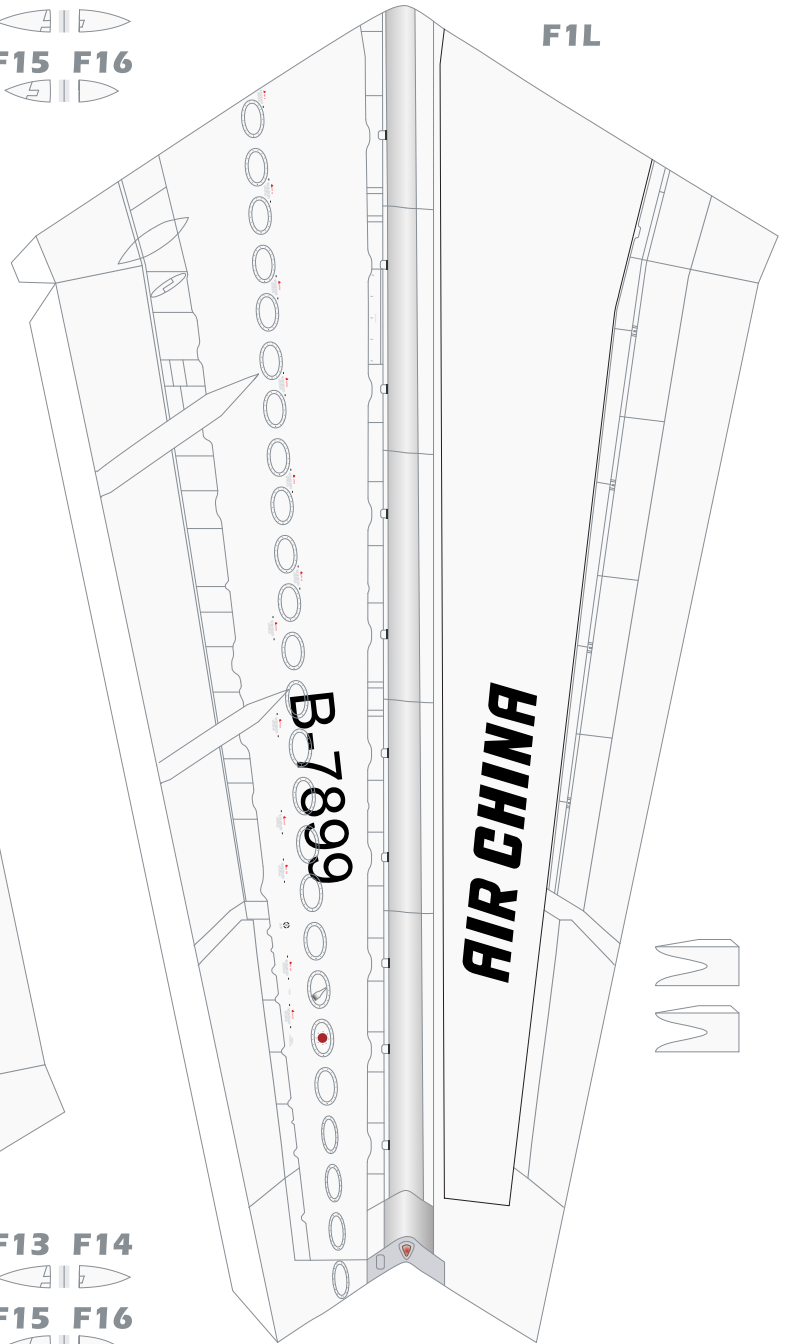

F13 F14



F15 F16

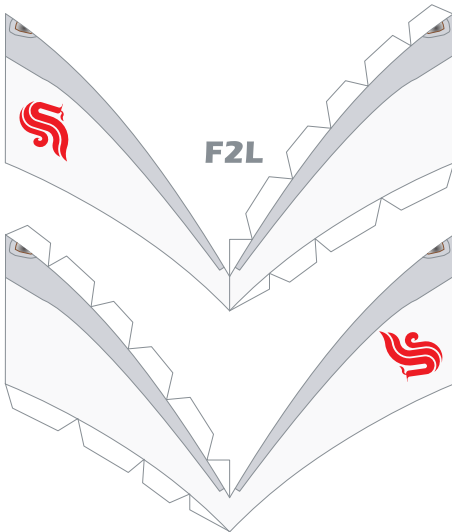

F2L

F2R

F3L



F4L

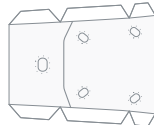

F5L



F5R



F4R

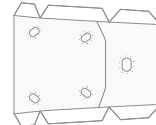

F3R



F6L



F7L

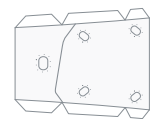

F8L



F8R



F7R

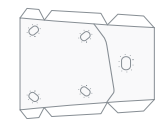

F6R



F9L



F10L



F11L



F11R



F10R



F9R



