

Blank space for 787-10 variant

Instructions



Scan

A14

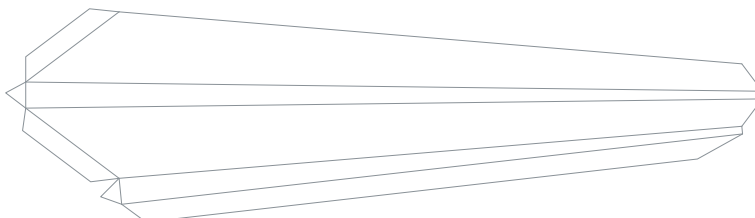

A16L

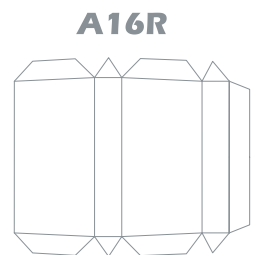
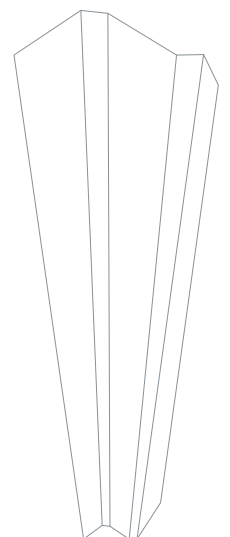

A16R

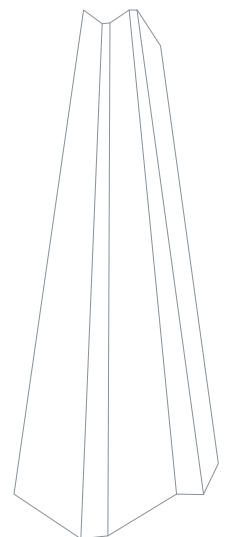

A17R

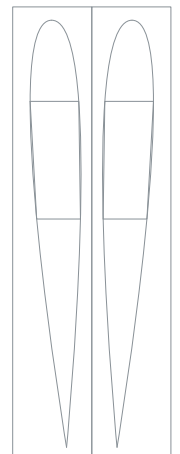

A20



A21



A22



A23



A24L



A24R

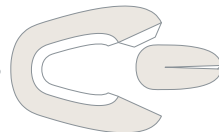

A18

A19

A17L

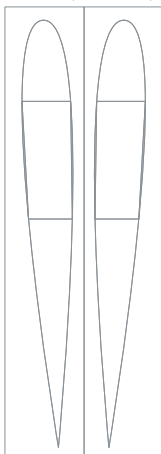

A6L

A6R

A1

A2

A3

A4

A5

A9

A10

A11

A12

A13

A15

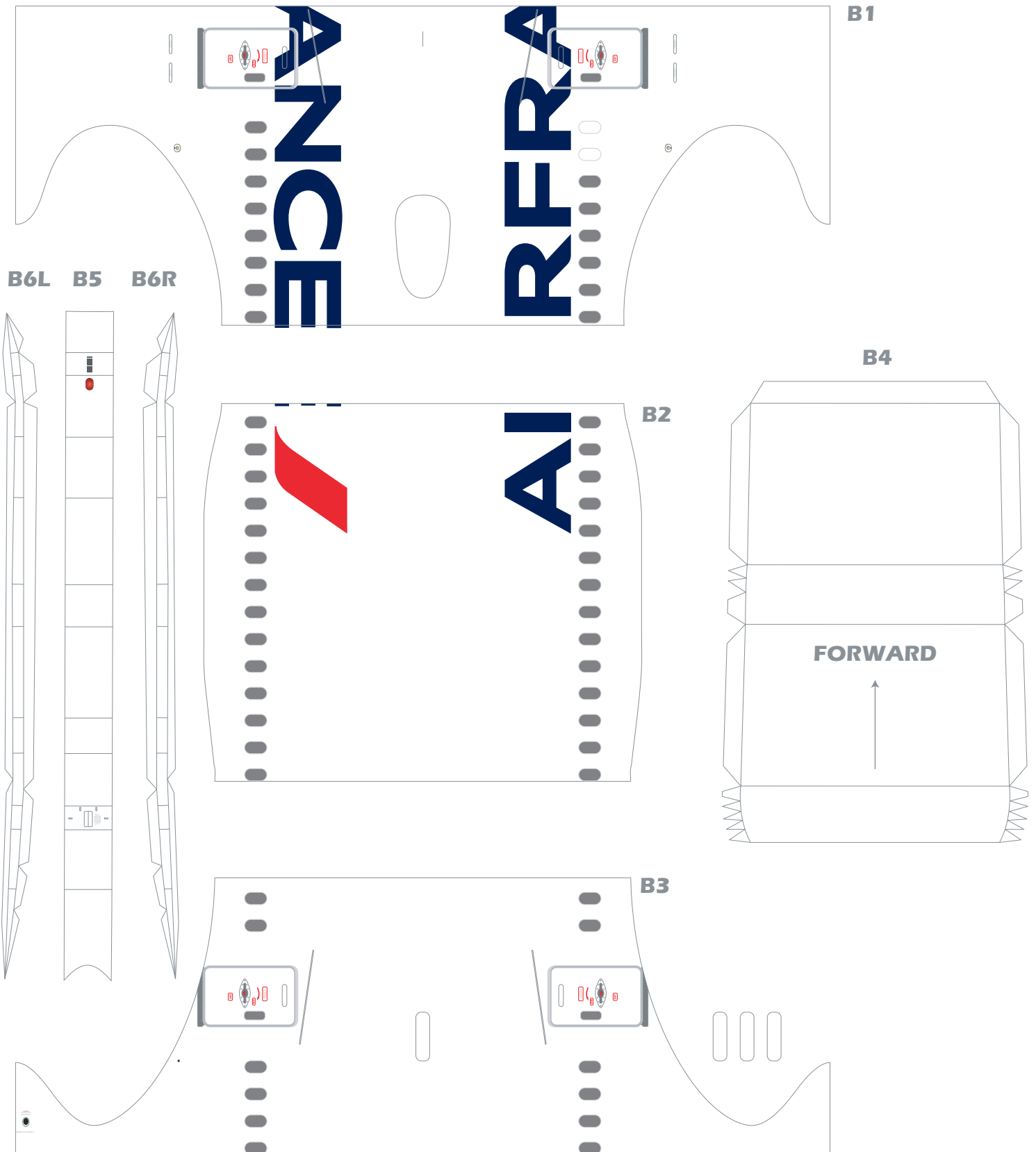

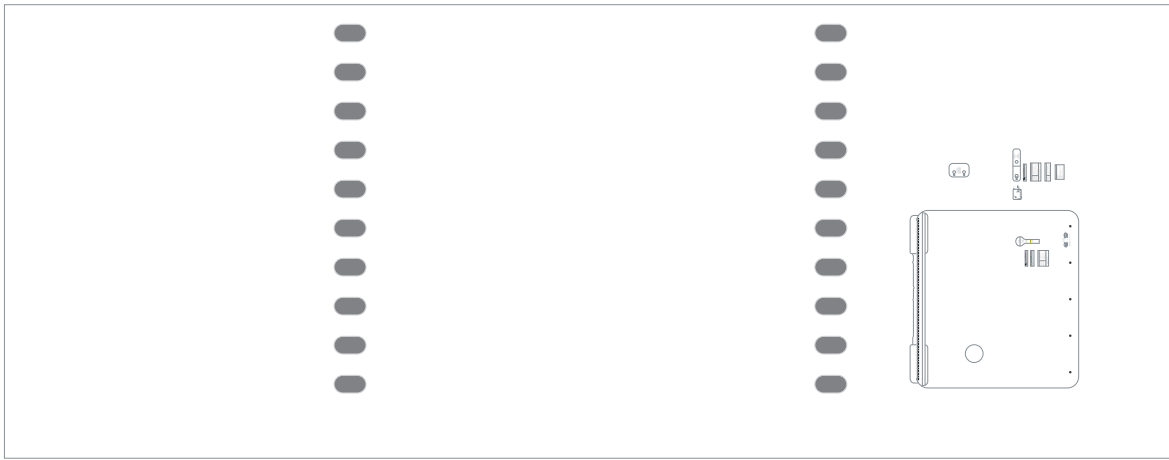

Blank space for 787-10 variant

C1

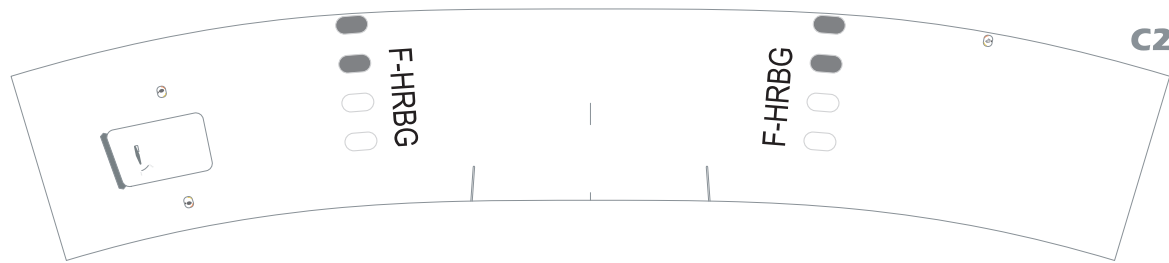
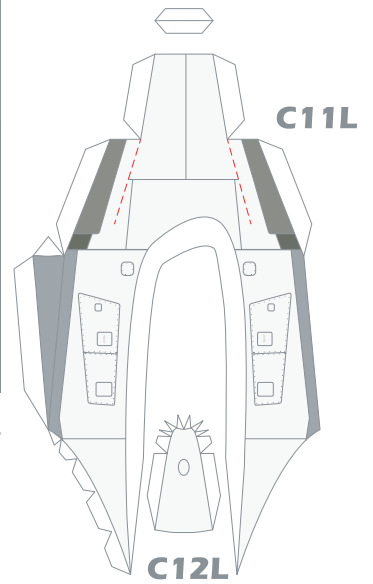

C2

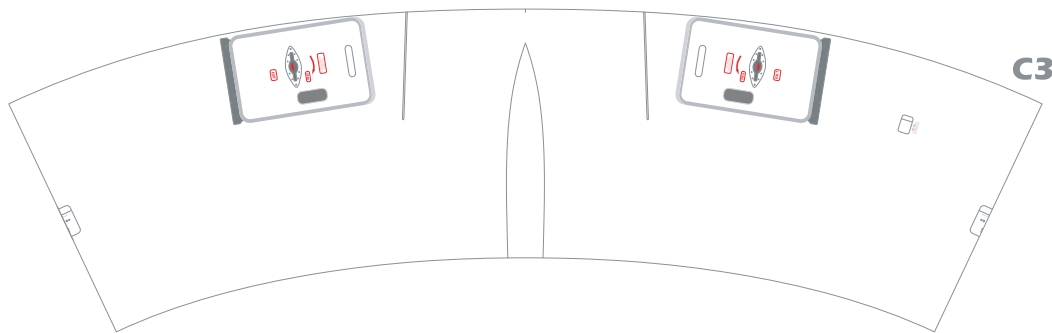
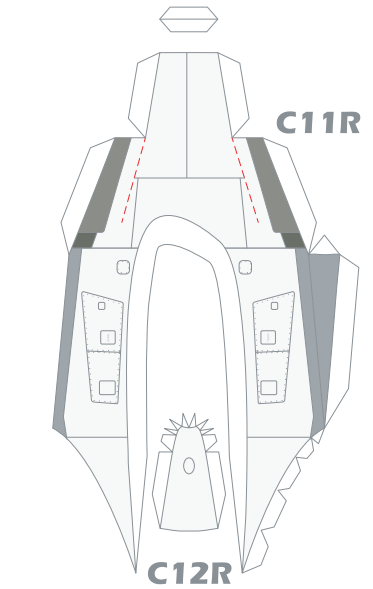

C3

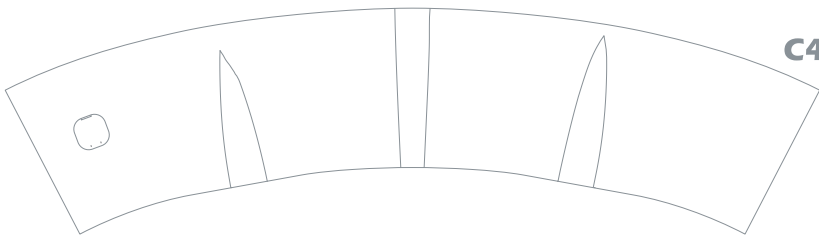

C4



C8

C9

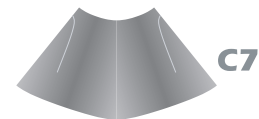

C7

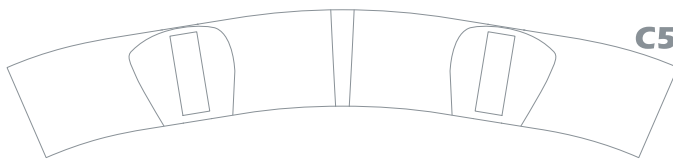

C5

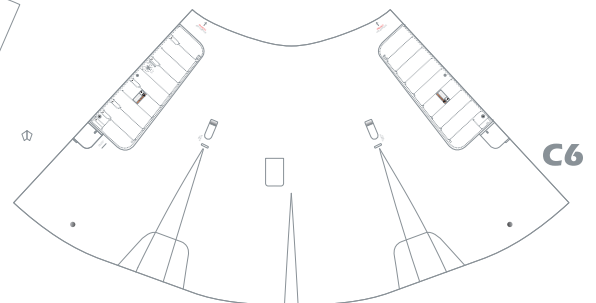

C6



C10L



C10R

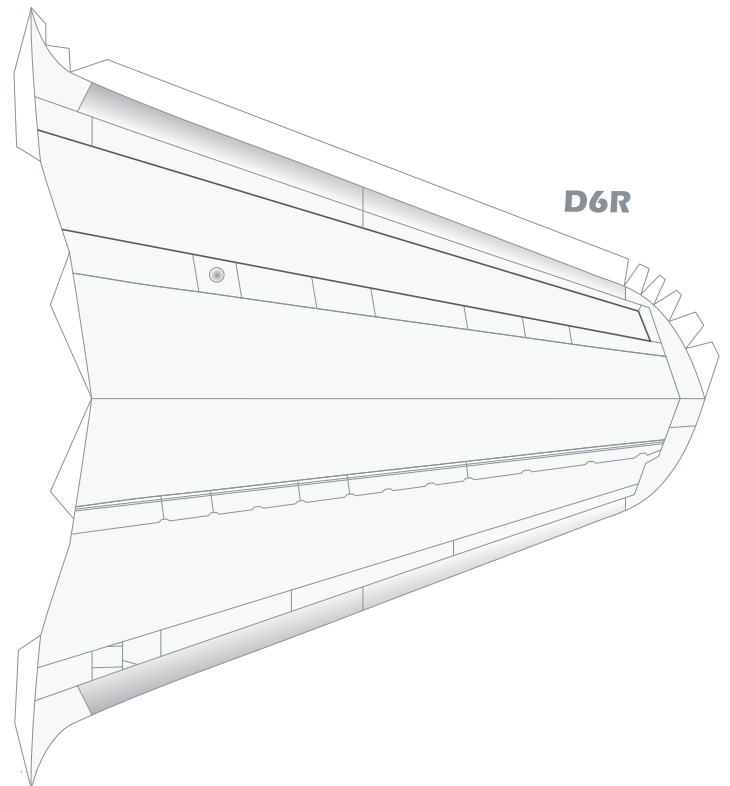
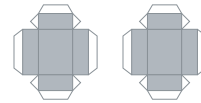
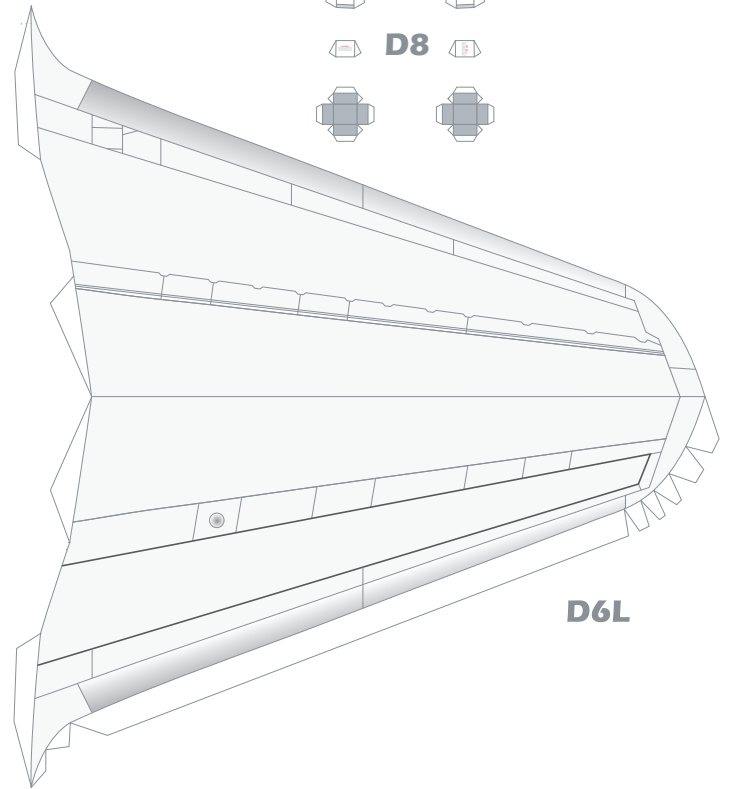
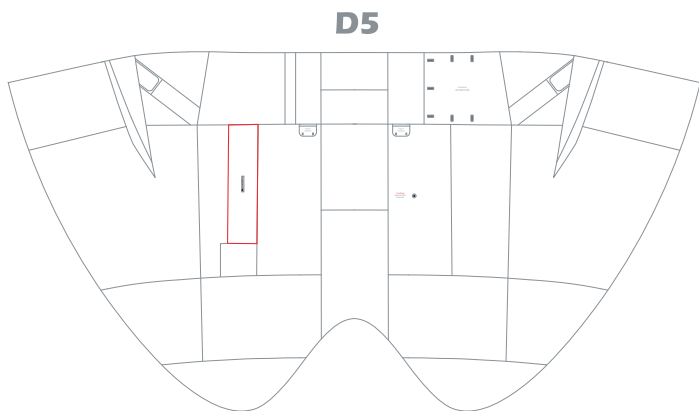
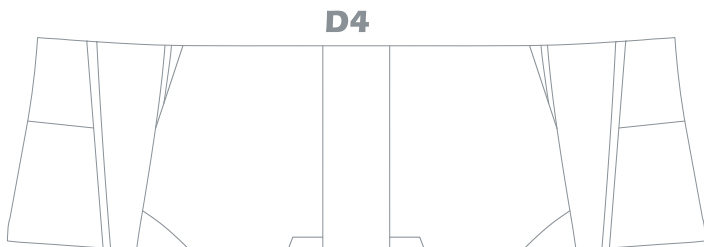
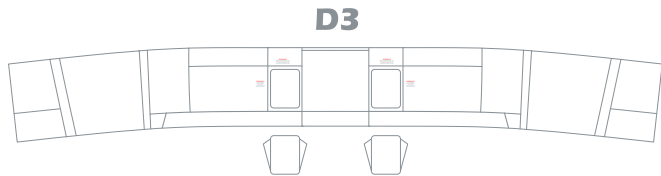
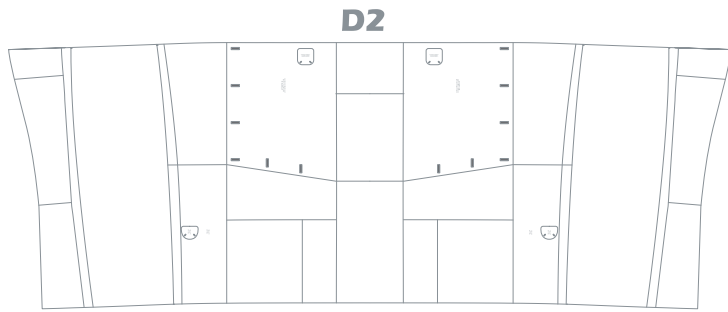
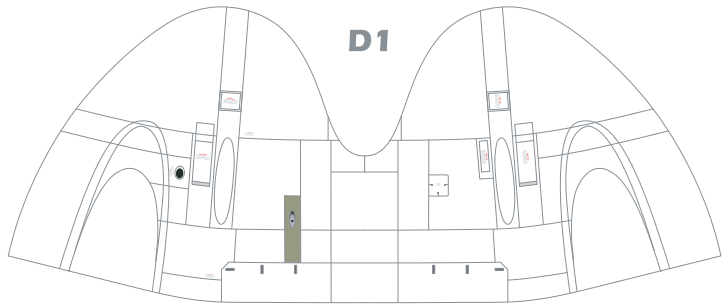

F1R

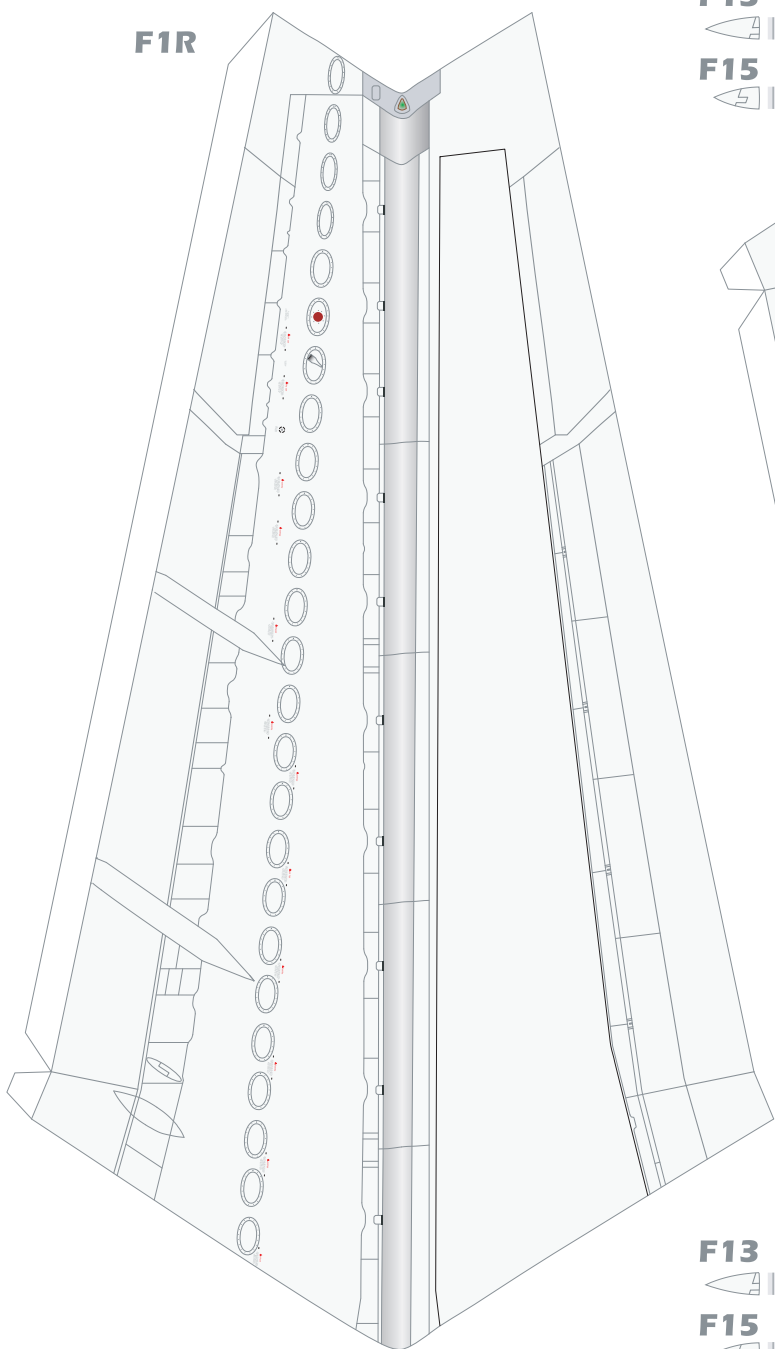

F13 F14



F15 F16



F1L

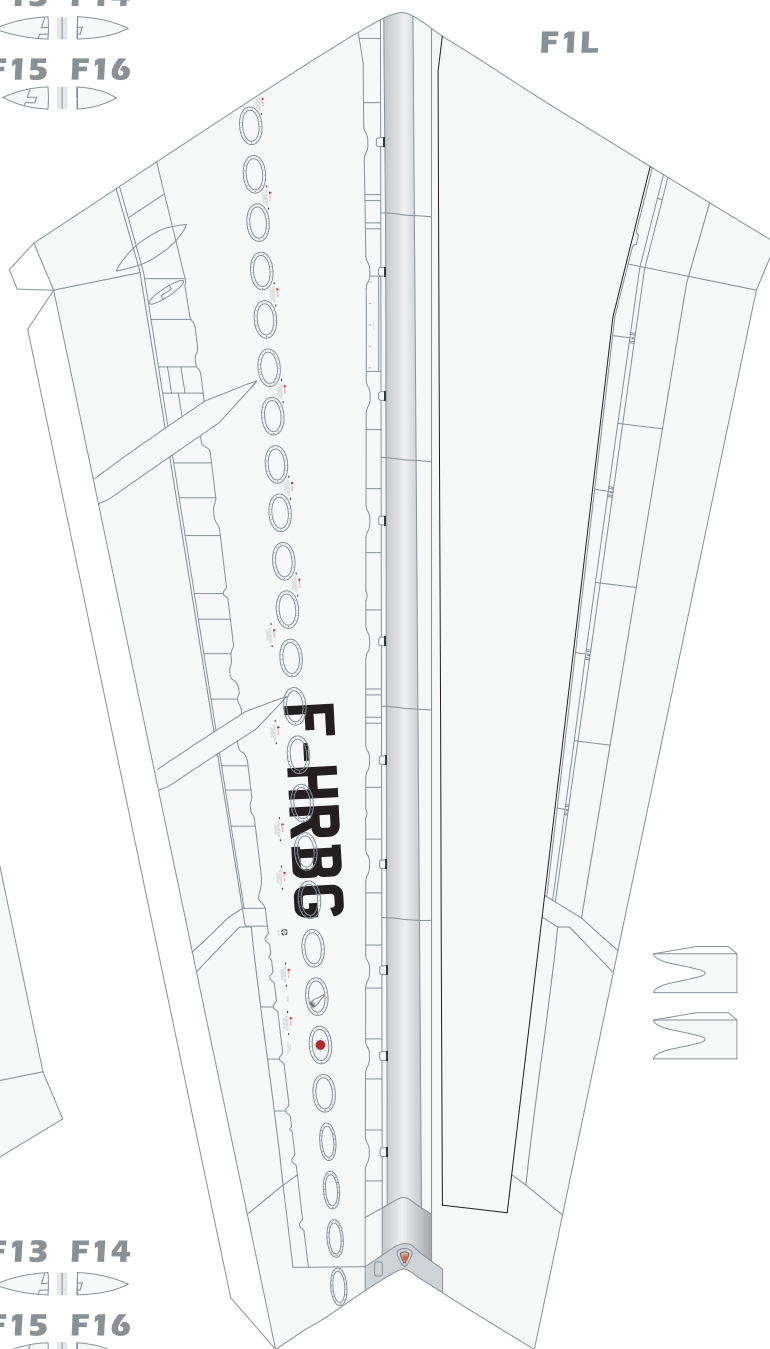

F13 F14



F15 F16

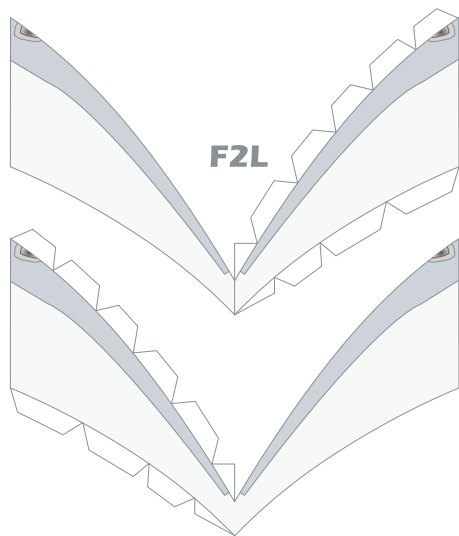

F2L

F2R

F3L



F4L

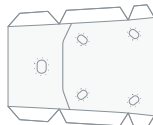

F5L



F5R



F4R

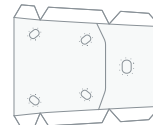

F3R



F6L



F7L

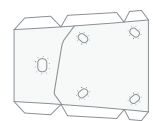

F8L



F8R



F7R

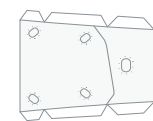

F6R



F9L



F10L



F11L



F11R



F10R

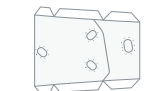

F9R



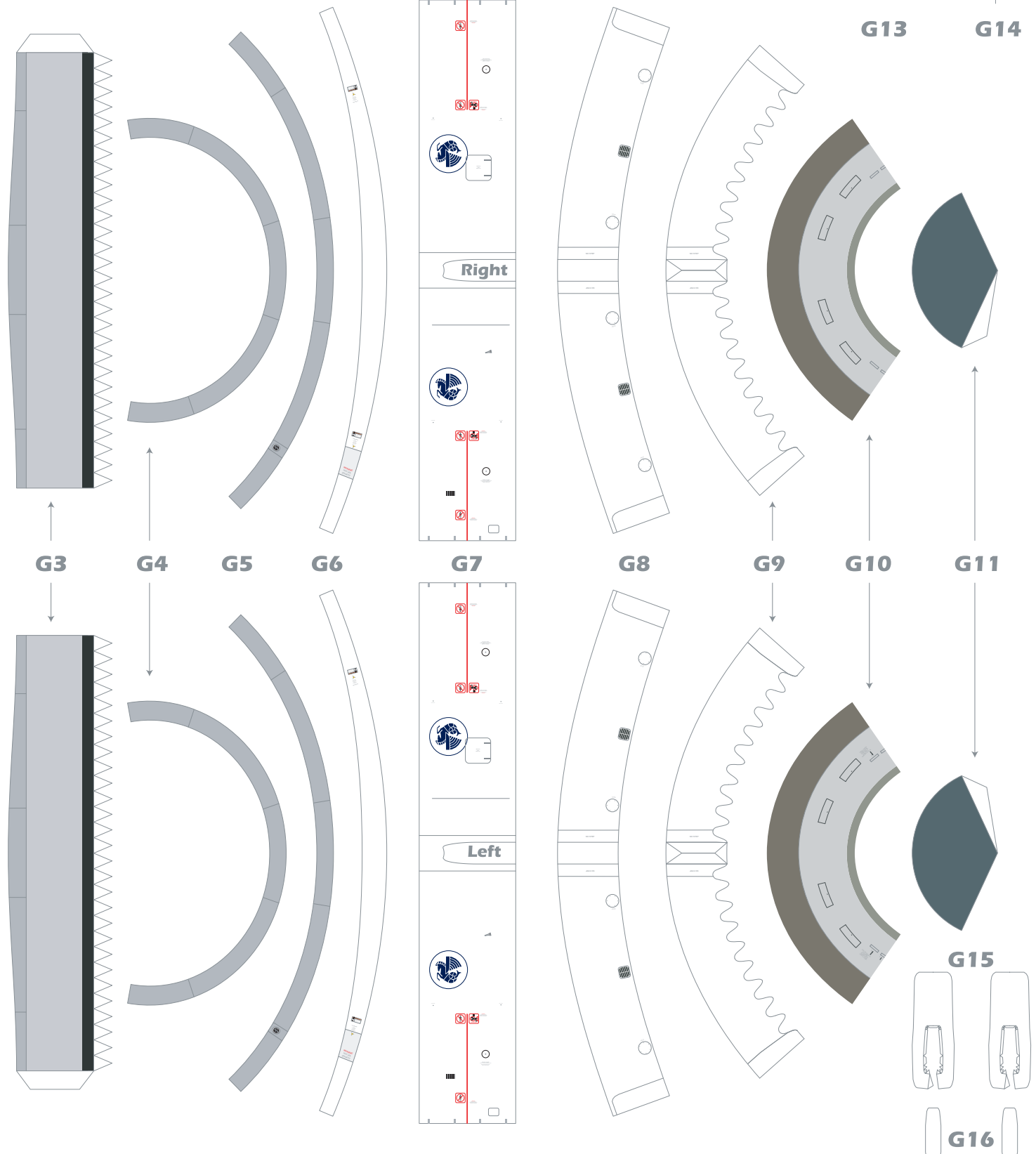
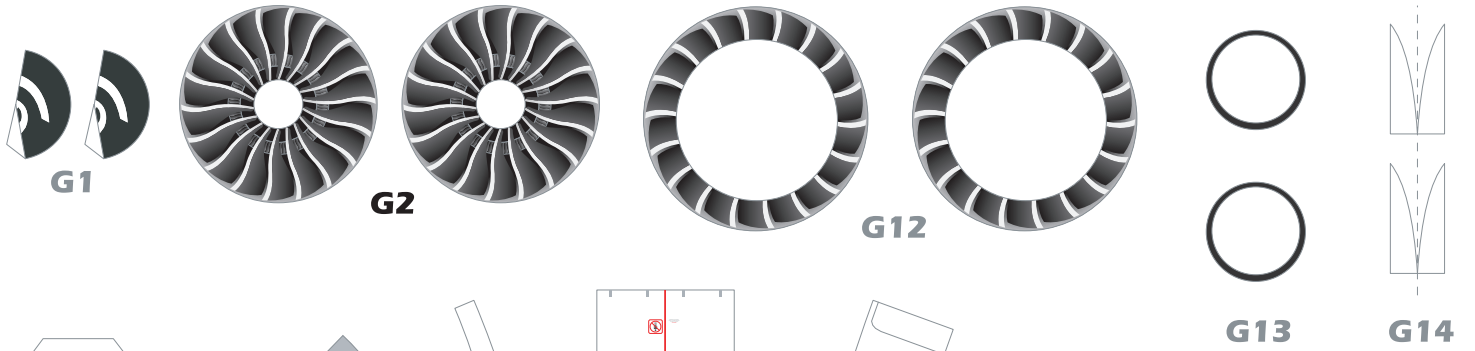

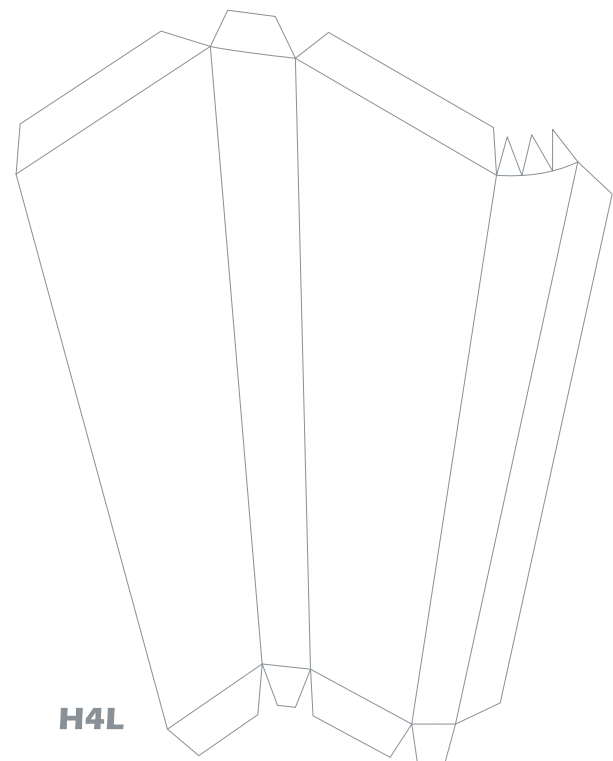
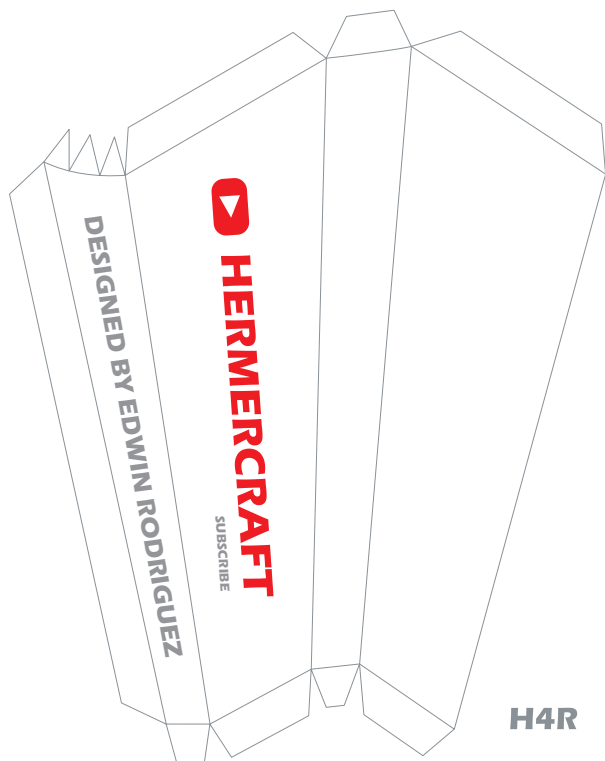
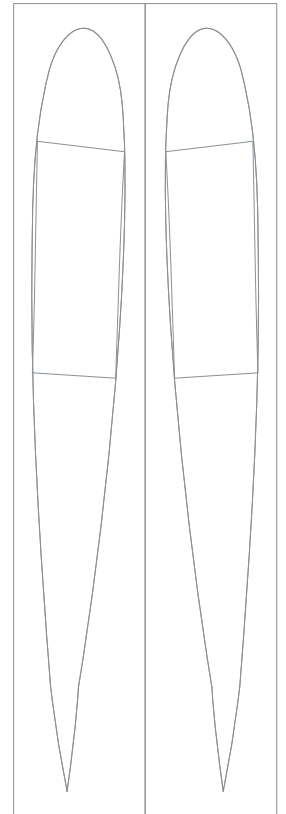
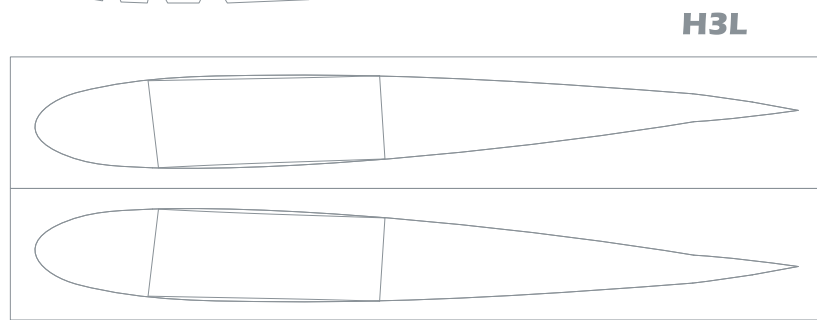
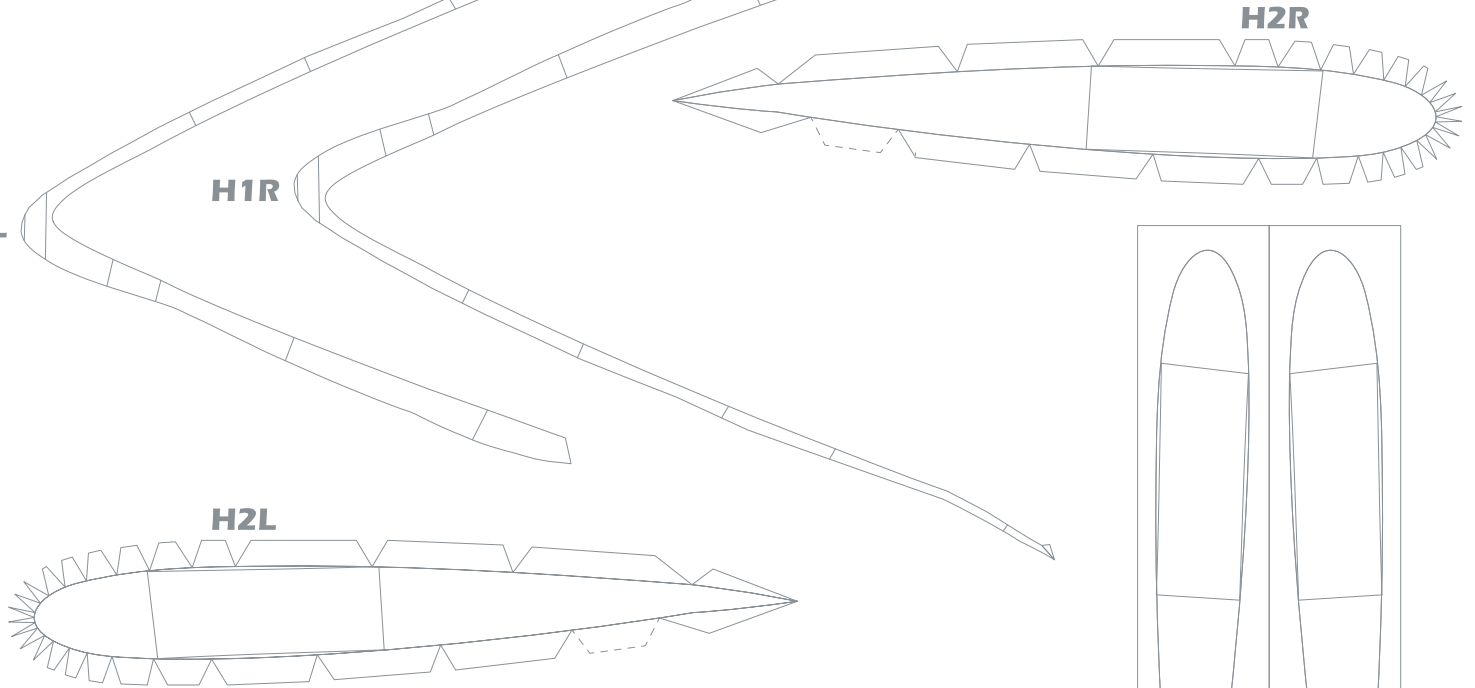
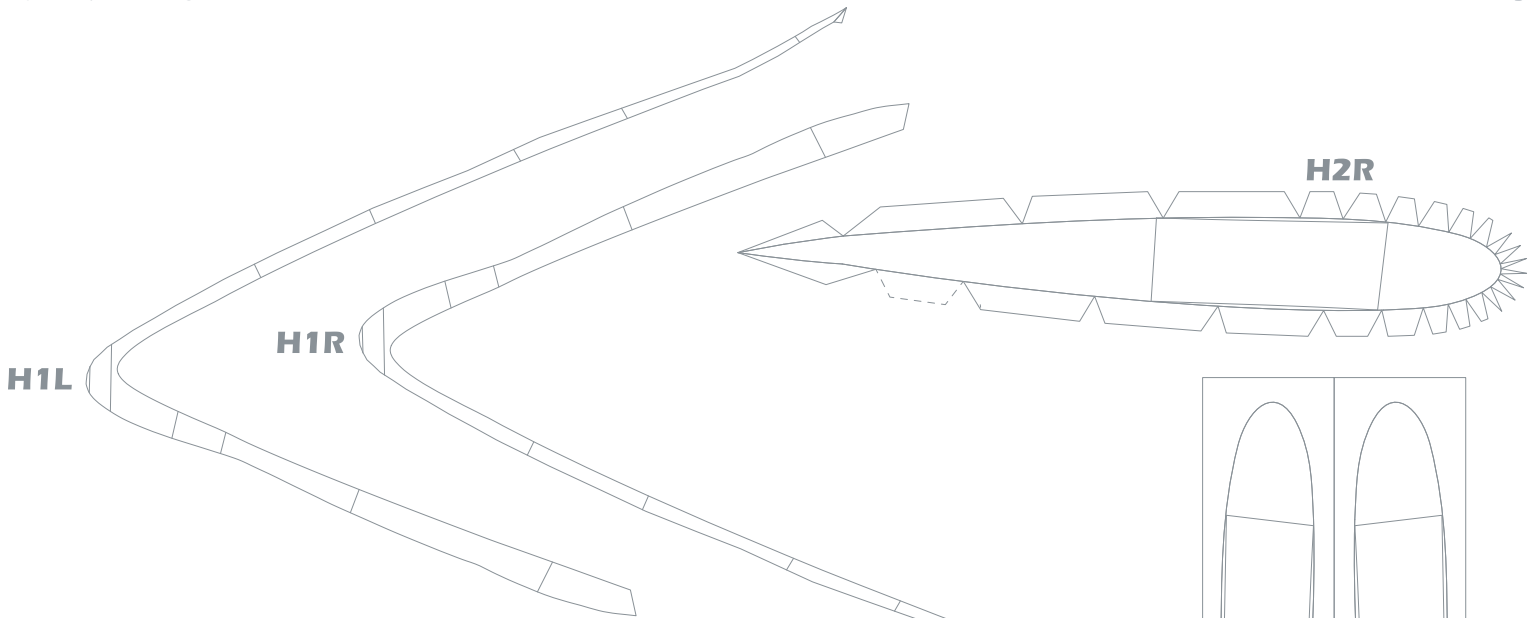

DESIGNED BY EDWIN RODRIGUEZ
HERMERCRAFT
SUBSCRIBE

H4R

H4L

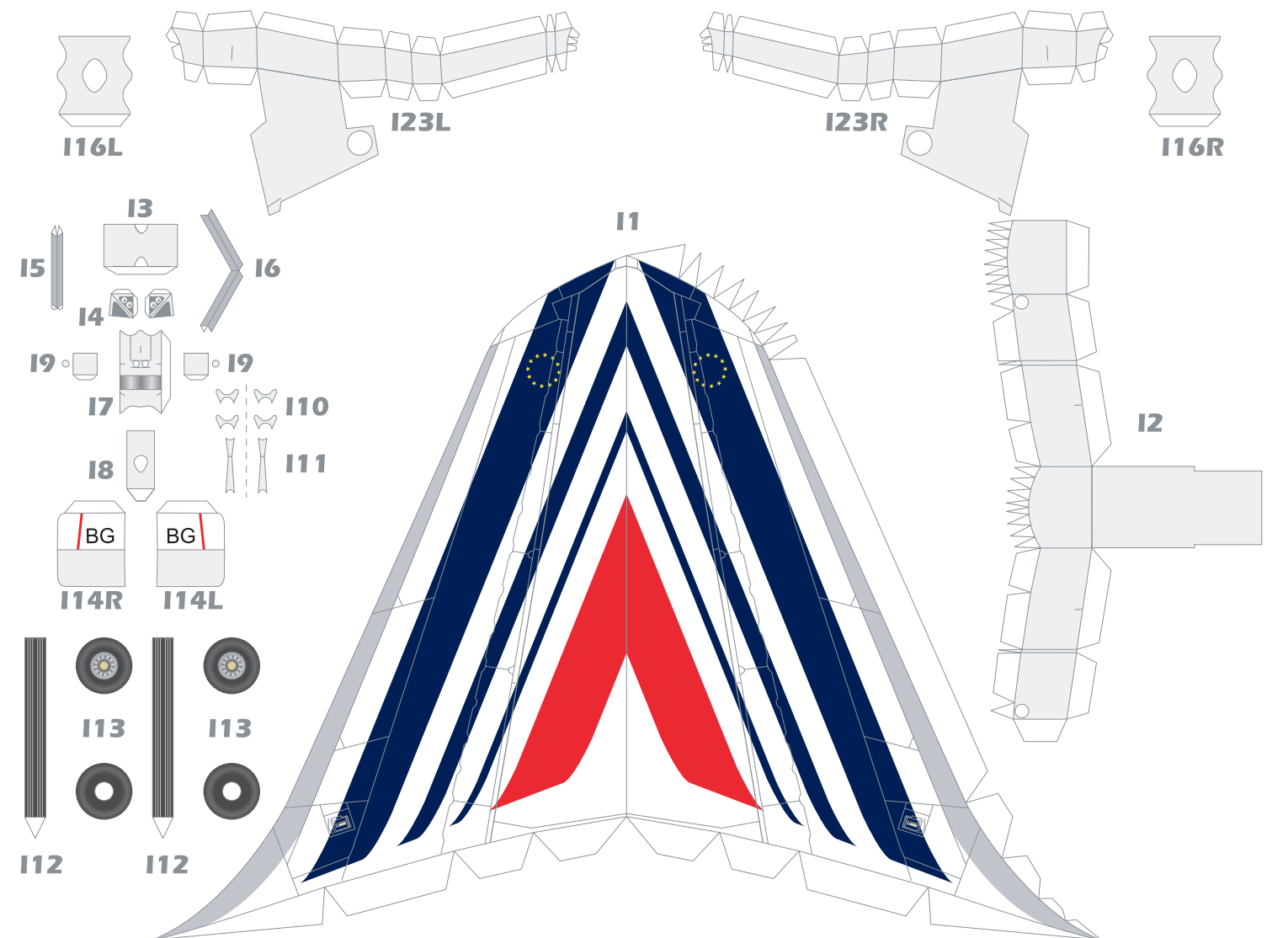
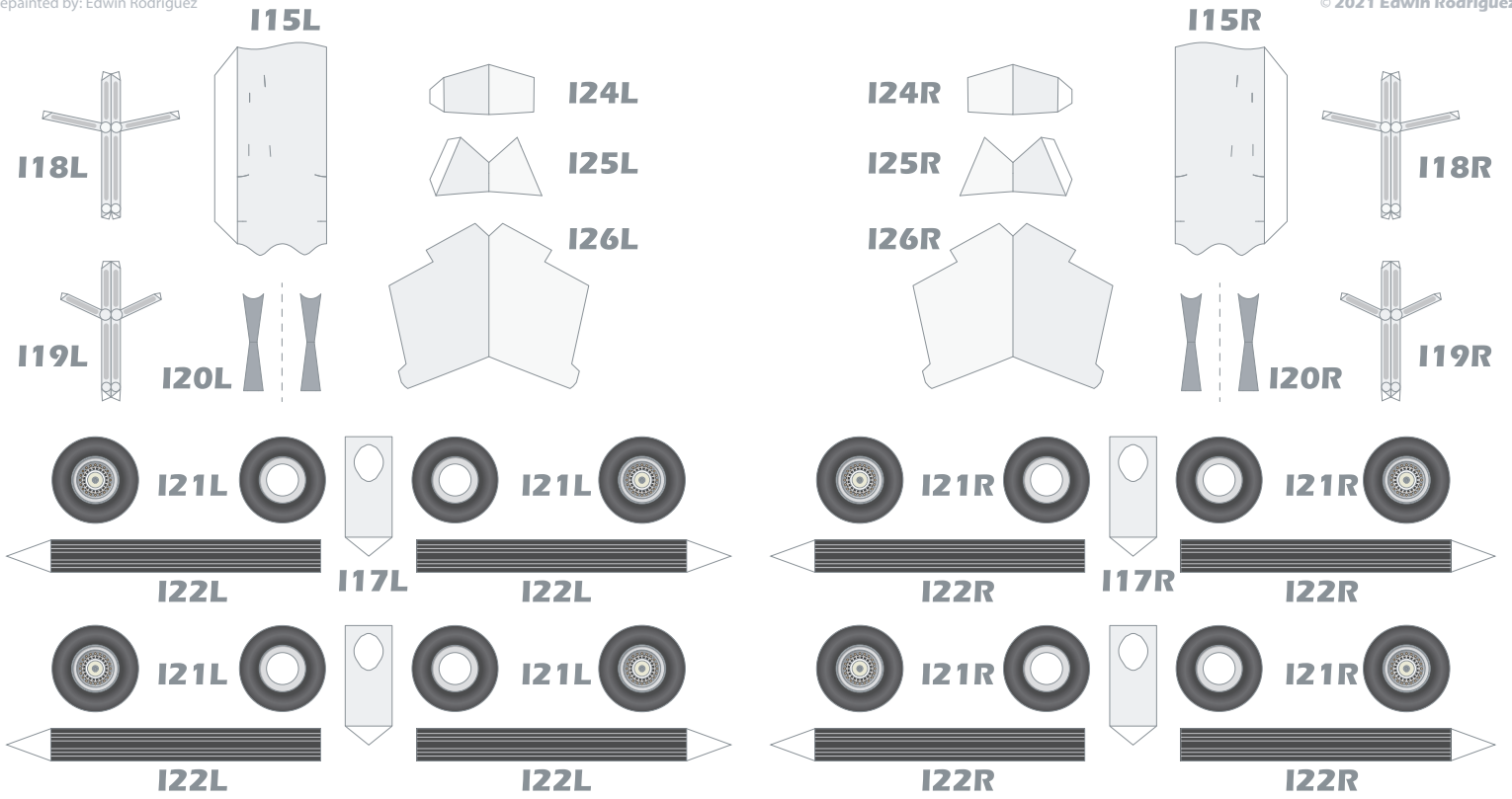

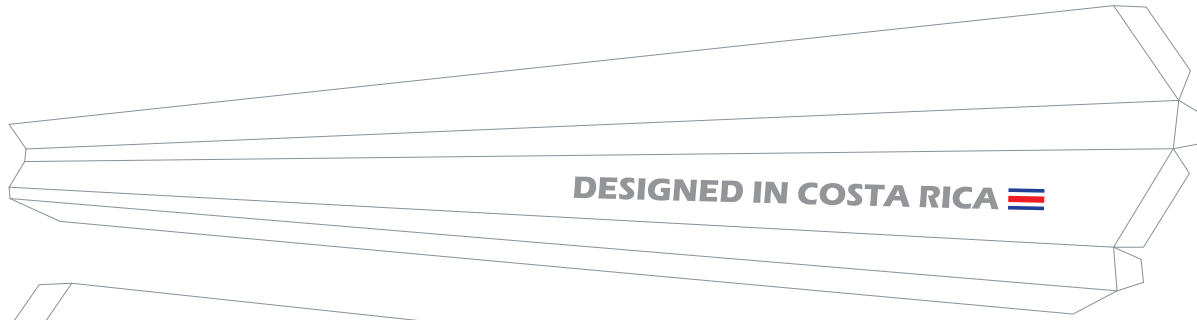

J1L



J1R

