

A13

A12

A11

A10

A7

A6

A8

A9

A4

A3

A2

A1

A14*

A15L*

A15R*

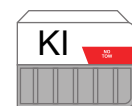

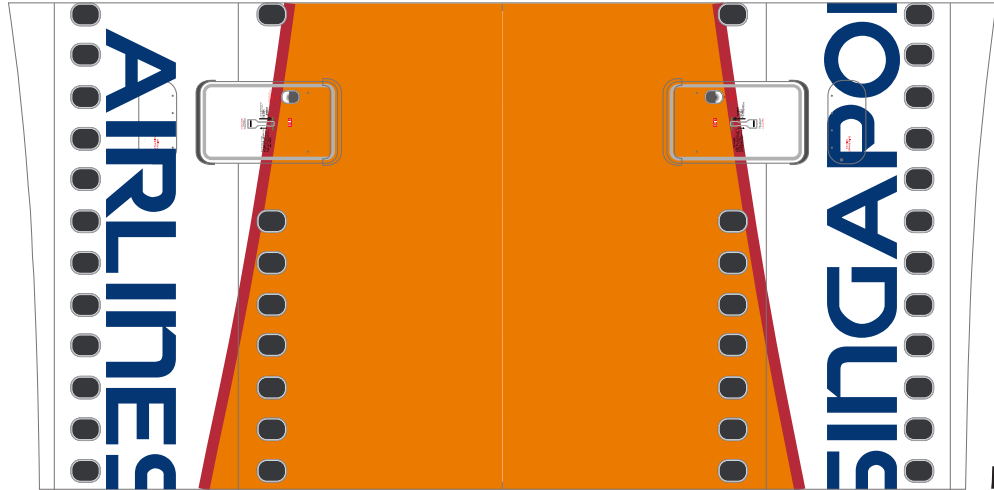

B4

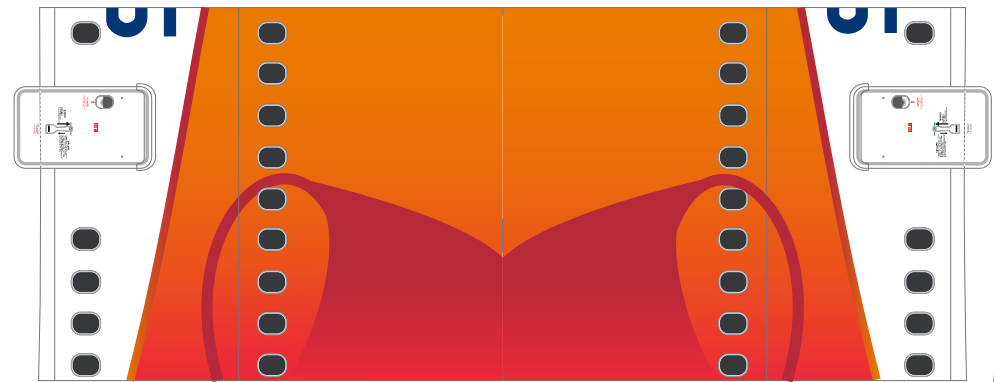

B3

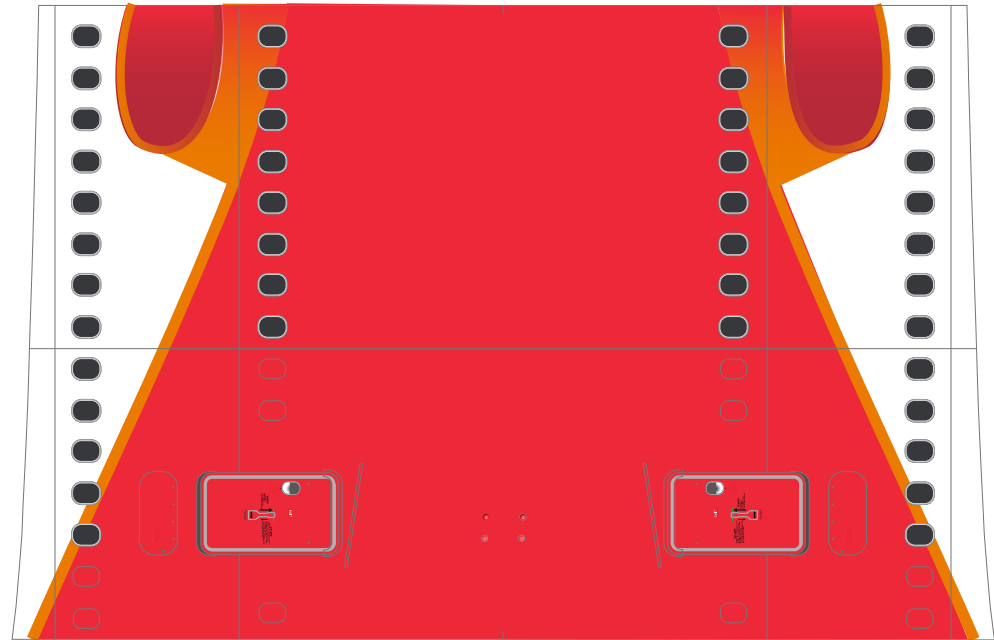

B2

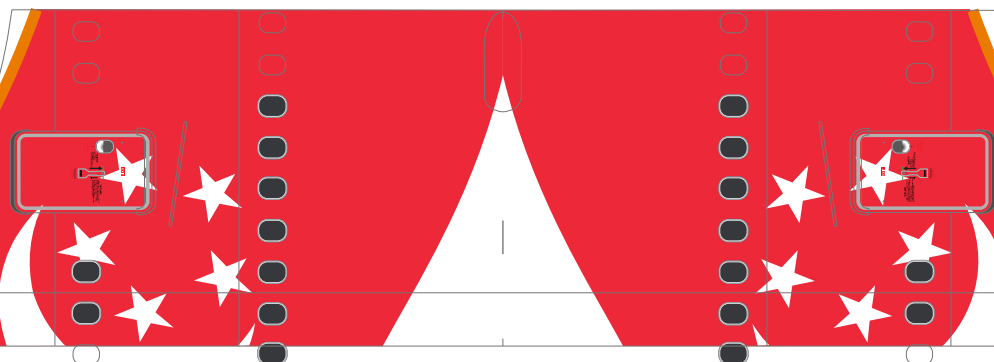

B1

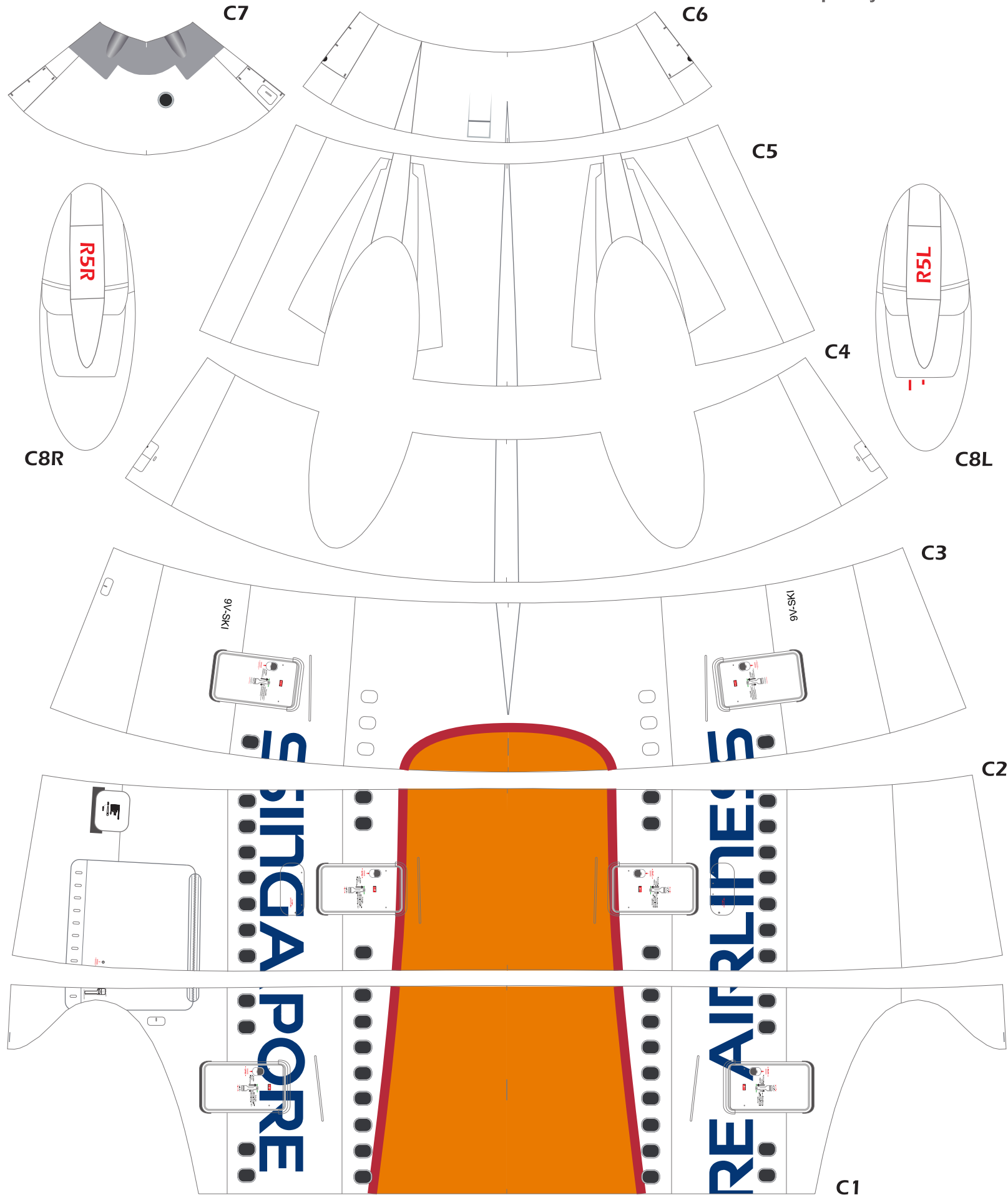

D6

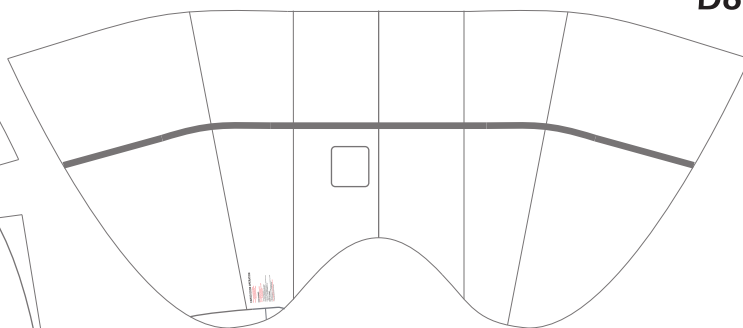
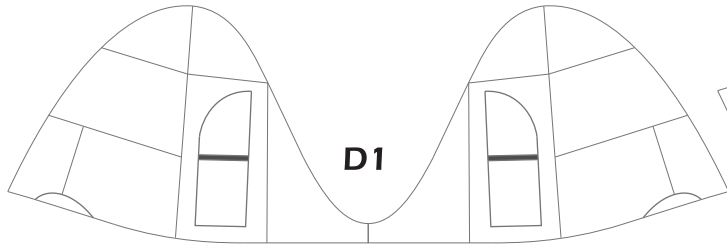

D2

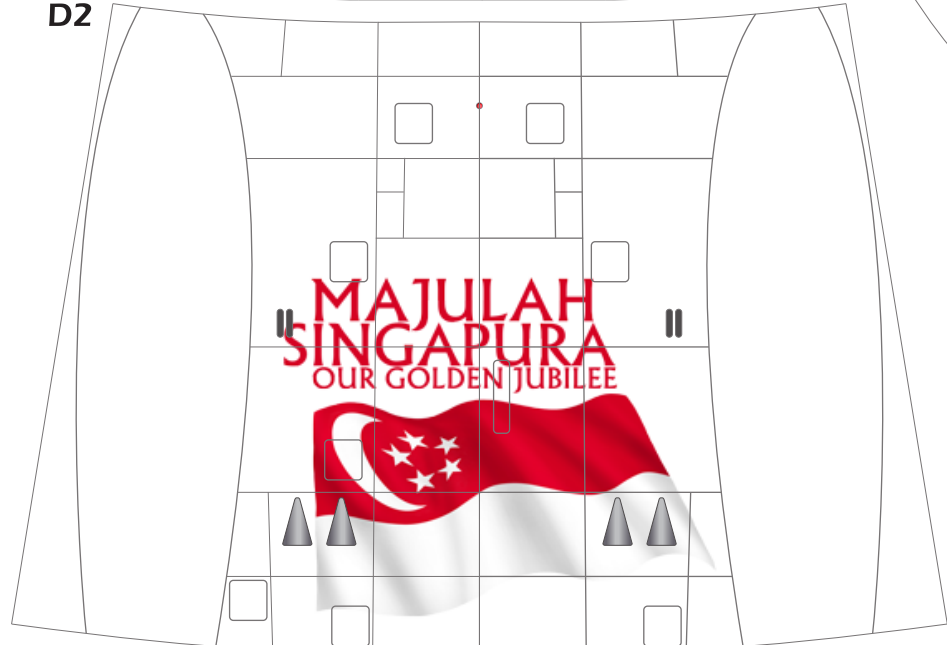

D8L*

D9L*

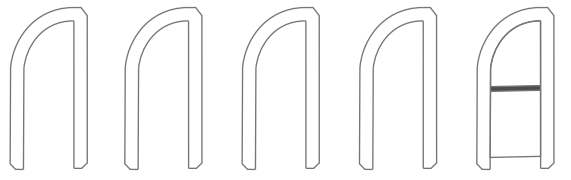
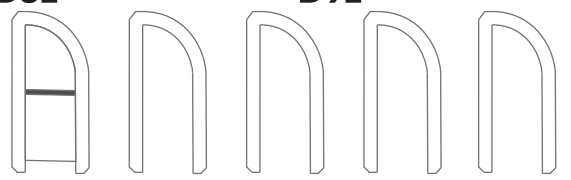

D9R*

D8R*

D3

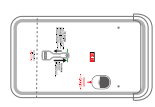

B3+D3 left door

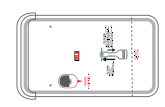

B3+D3 right door

D7R*

D7L*

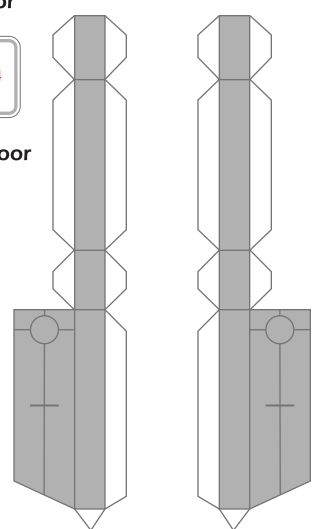

D4

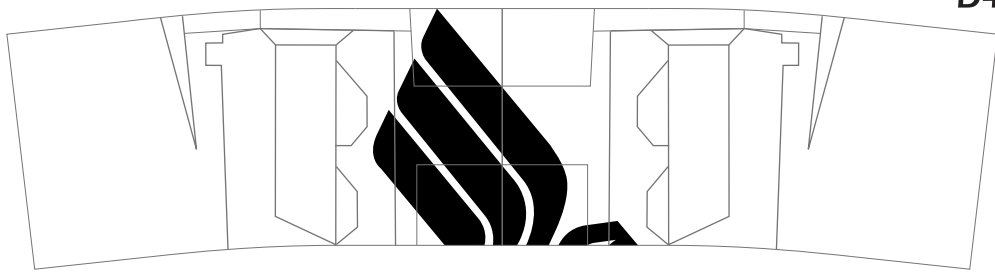

D5

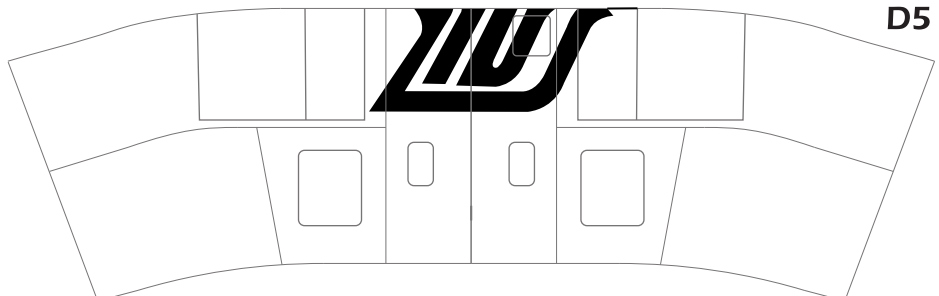

AIRBUS A380-800

SINGAPORE AIRLINES

HERMERCRAFT

© 2019 Edwin Rodriguez

 HERMERCRAFT

Redraw By Mario Solorzano

Repaint By Michael Tsai



F1L

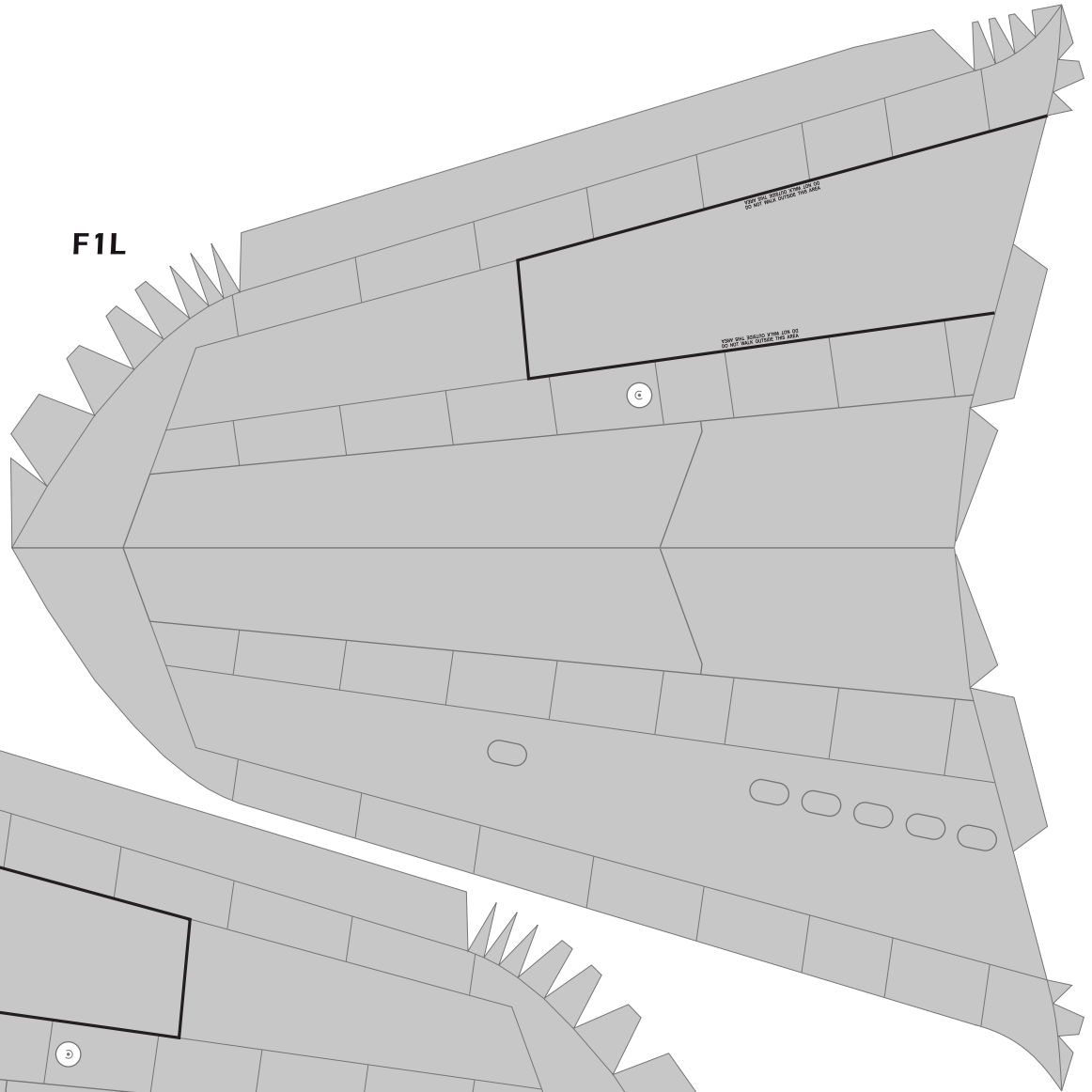

F1R

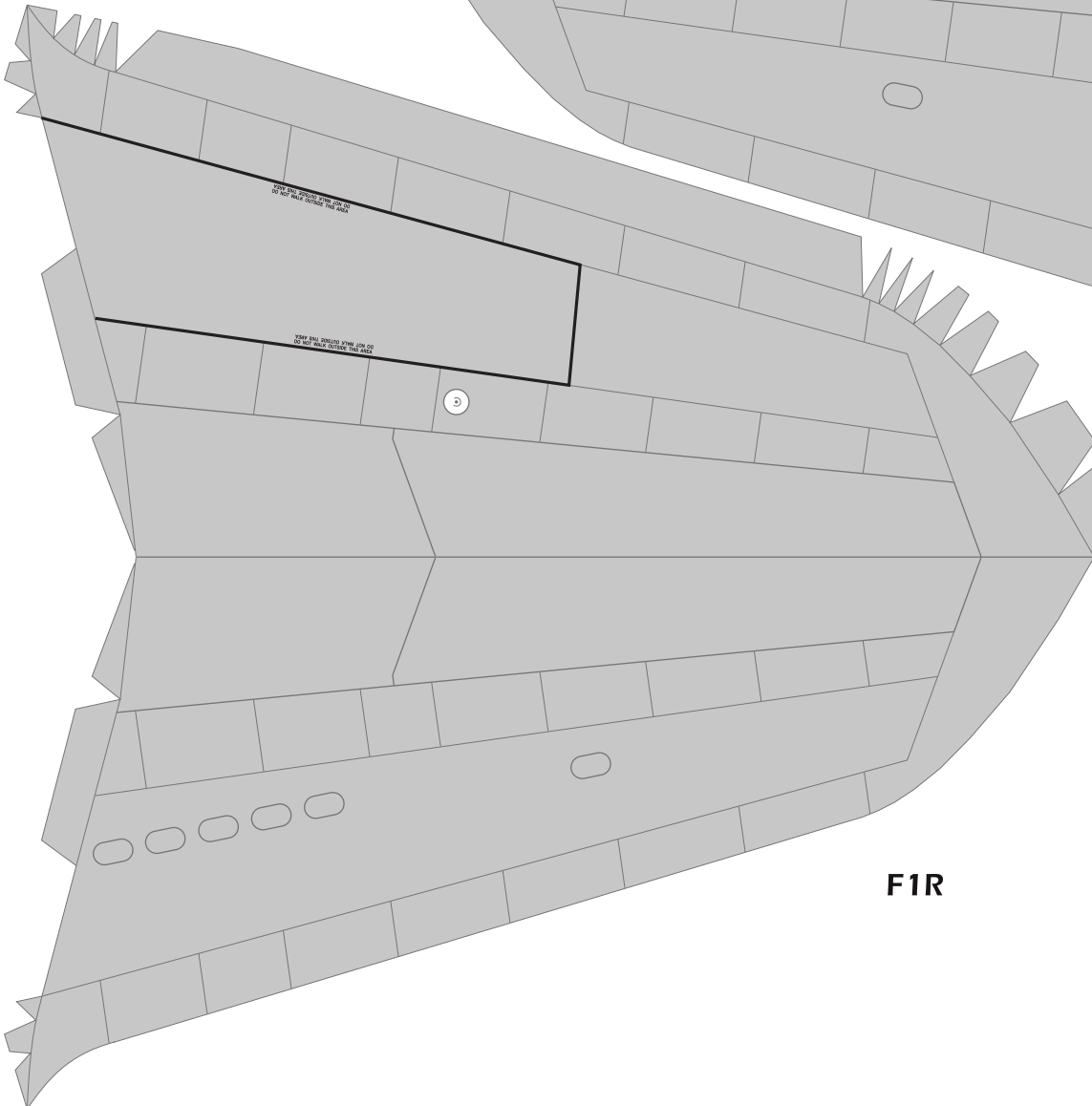

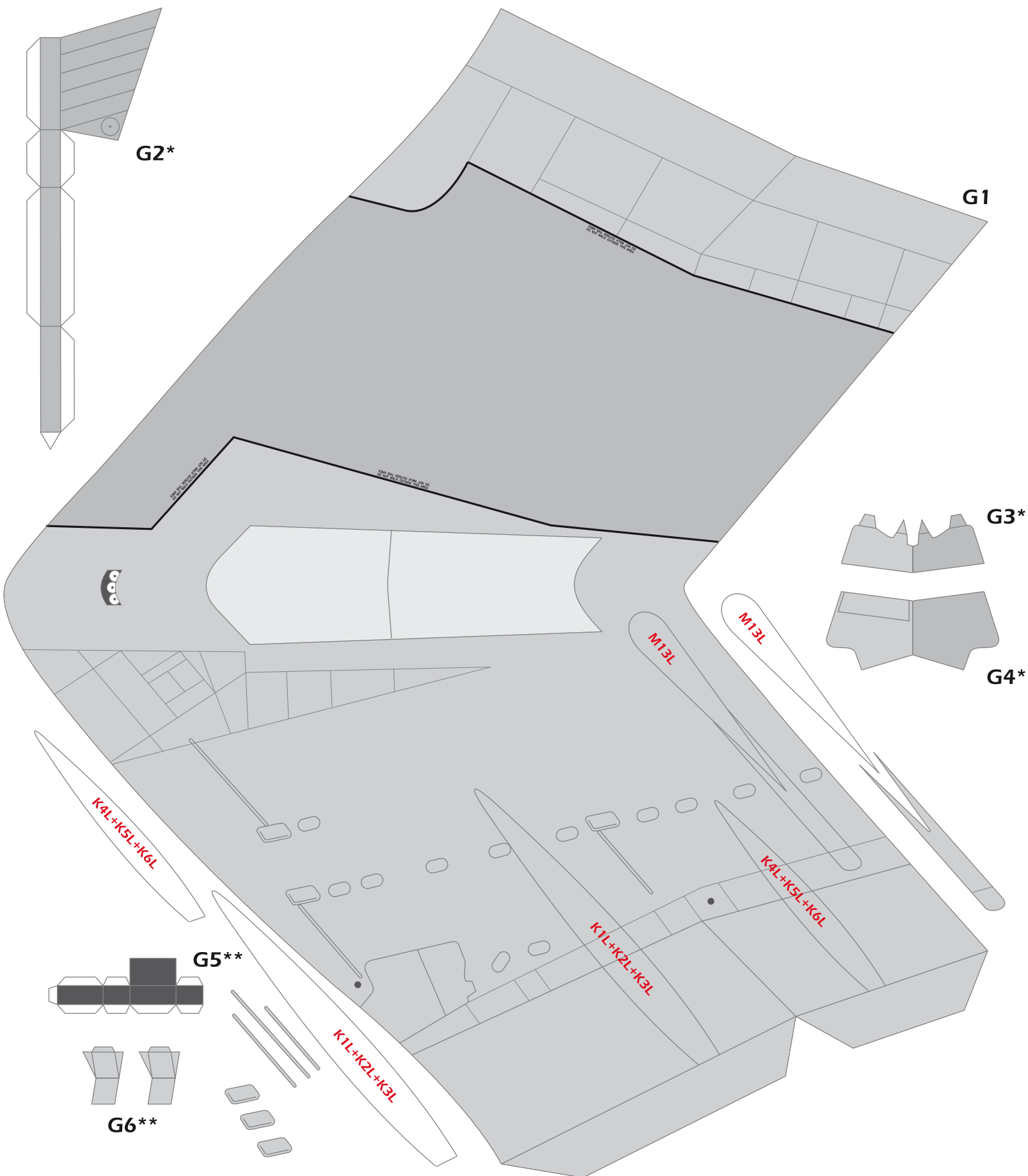

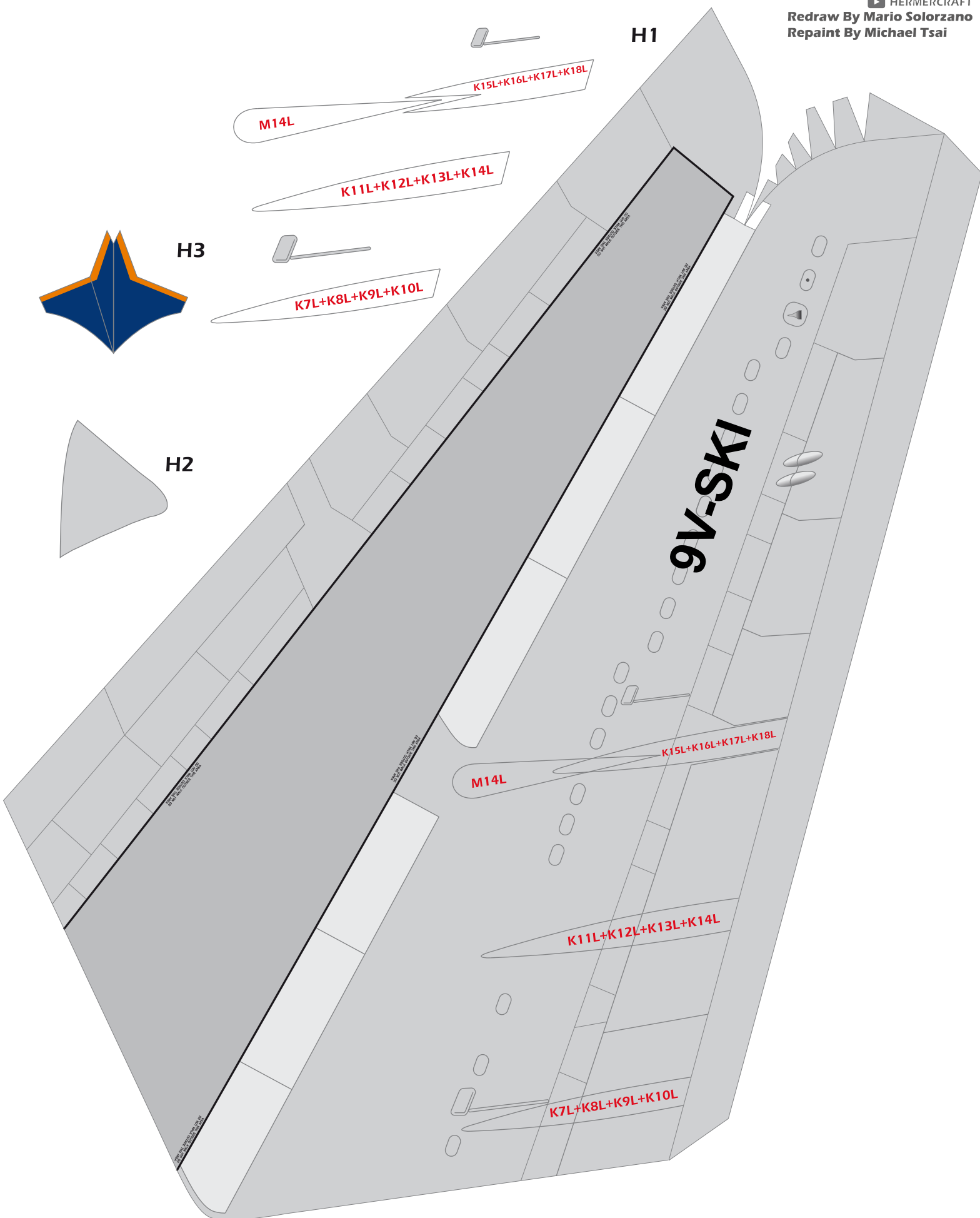

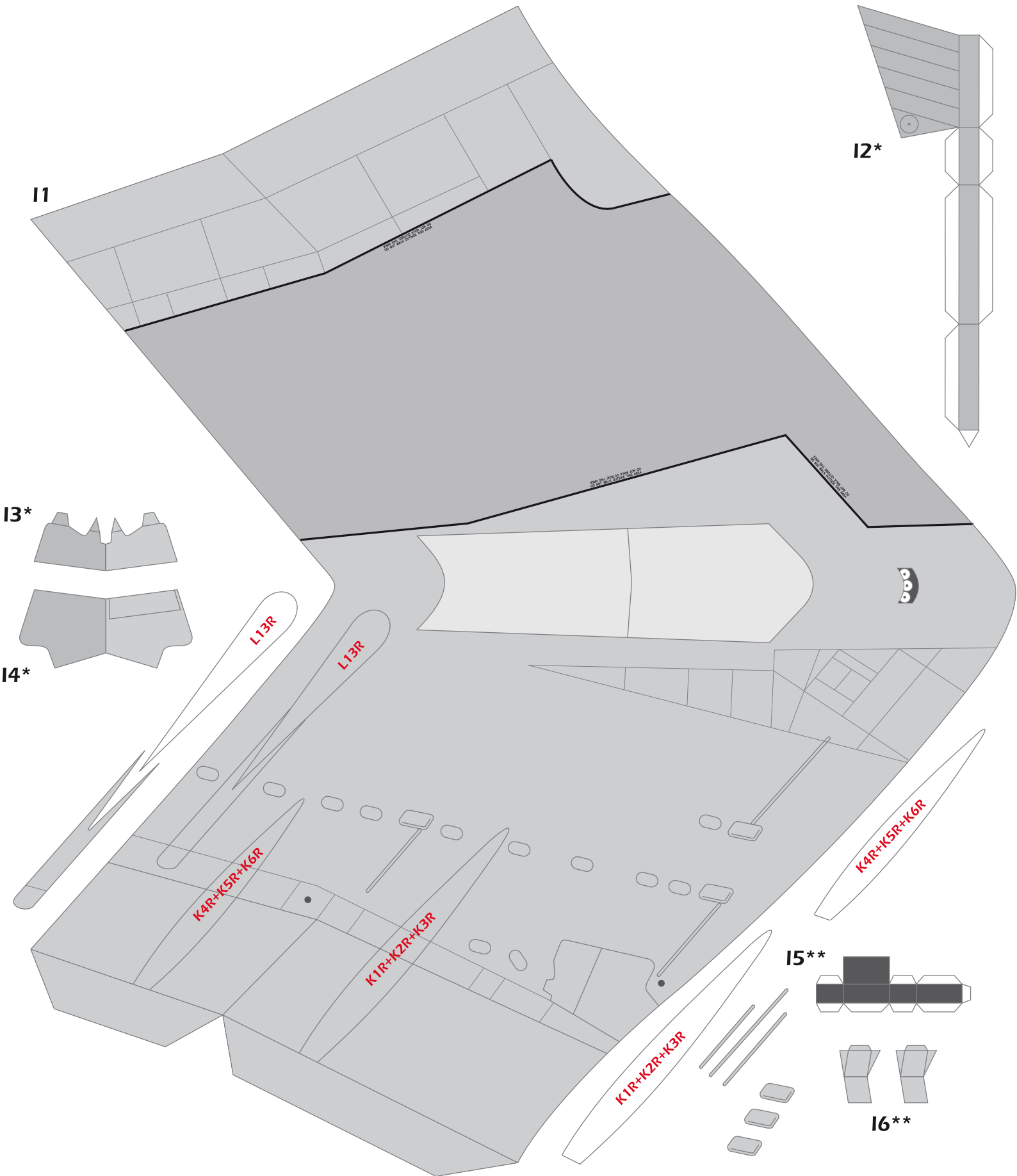

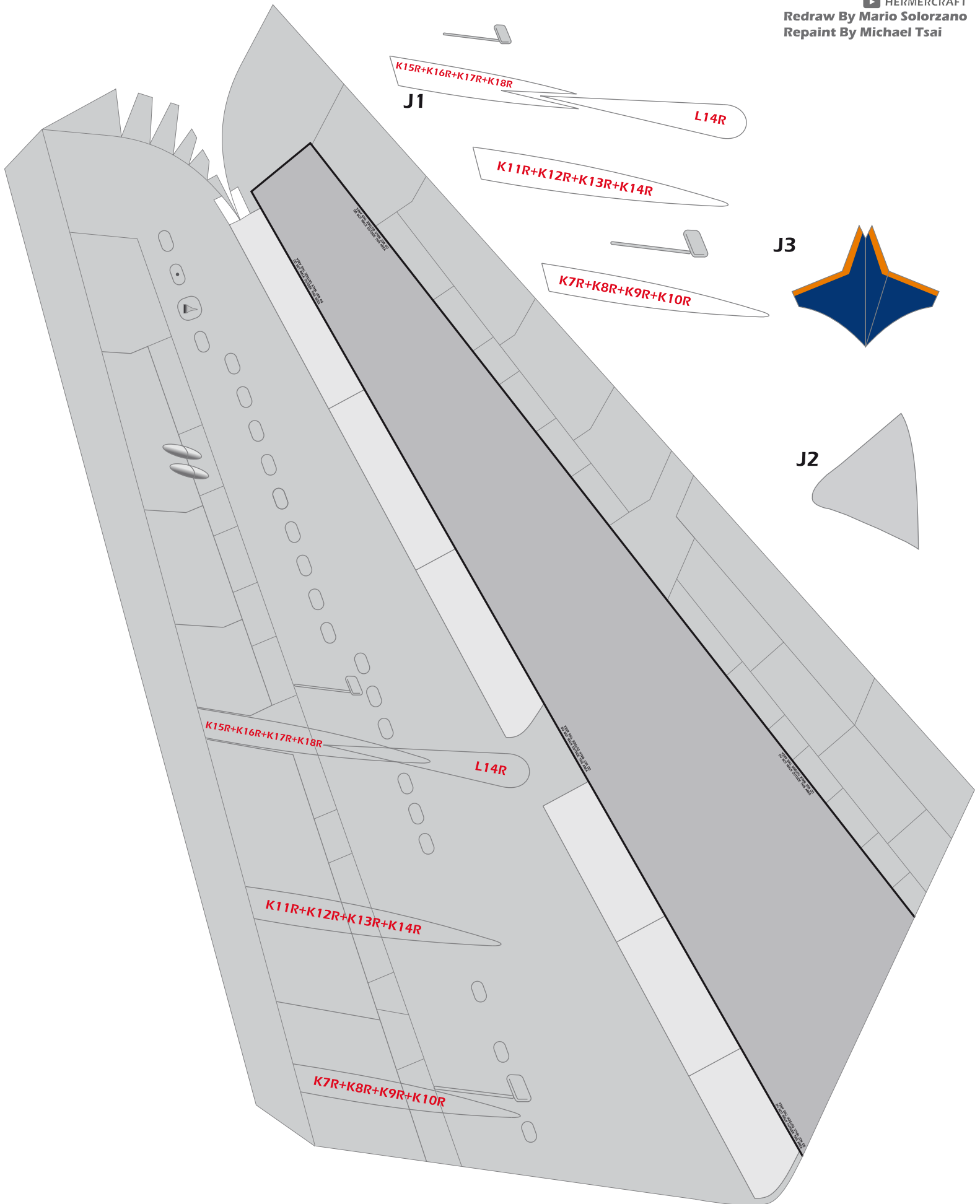

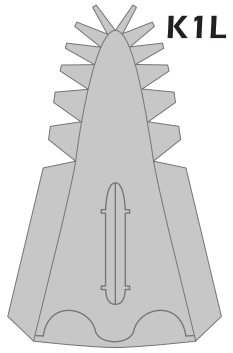

K1L

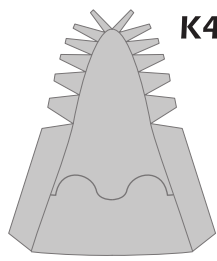

K4L

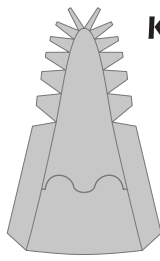

K7L

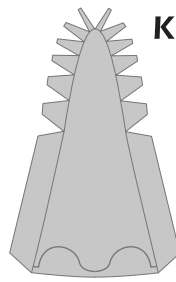

K11L

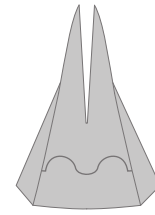

K15L



K5L



K8L



K12L

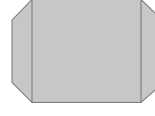

K16L



K2L

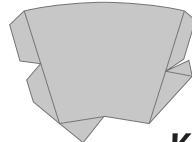

K6L

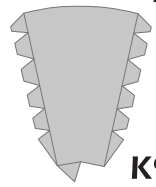

K9L

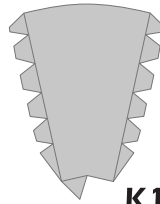

K13L

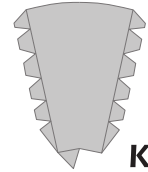

K17L

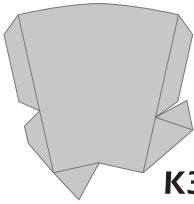

K3L



K10L



K14L



K18L

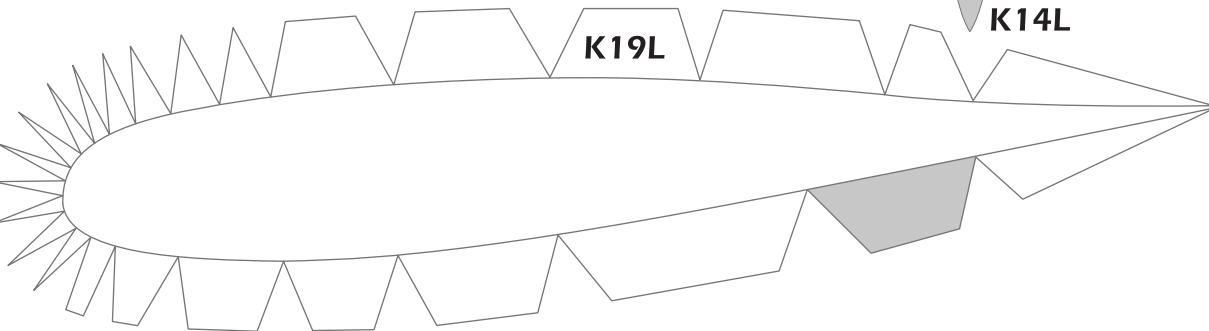

K19L

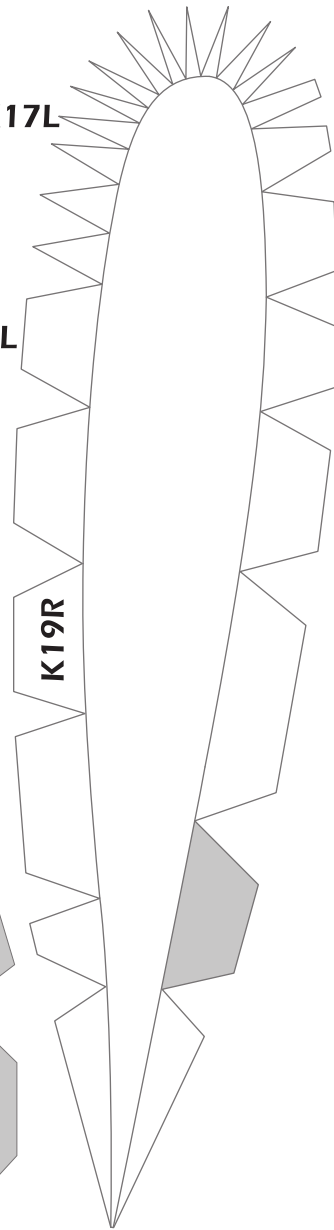

K19R

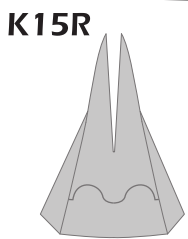

K15R

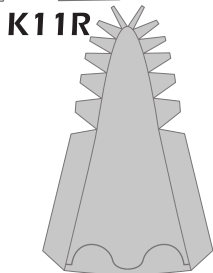

K11R

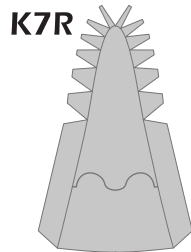

K7R

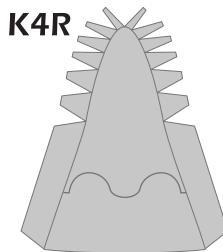

K4R

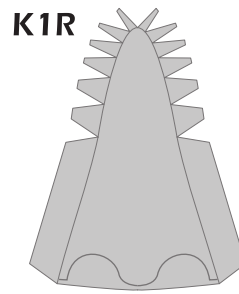

K1R



K16R



K8R



K5R



K12R

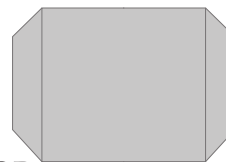

K2R

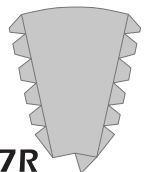

K17R

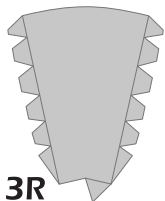

K9R

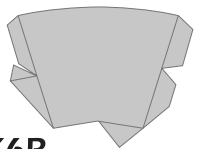

K6R

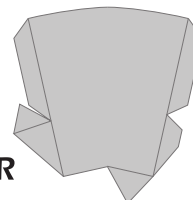

K3R



K18R

K13R



K14R



K10R

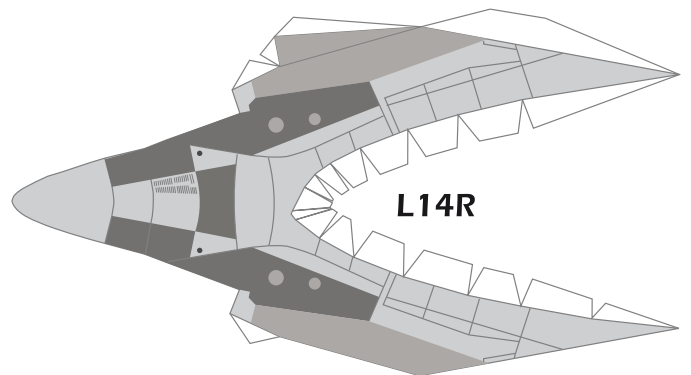
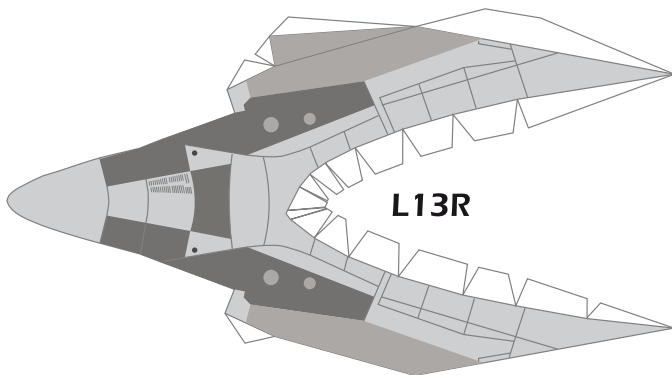
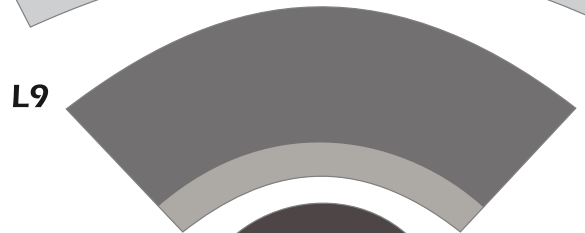
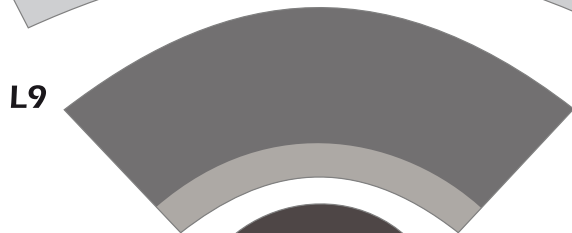
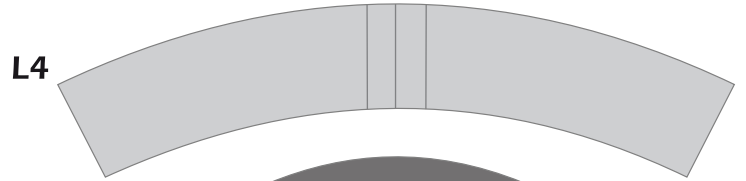
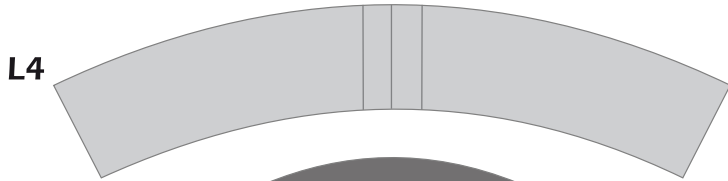
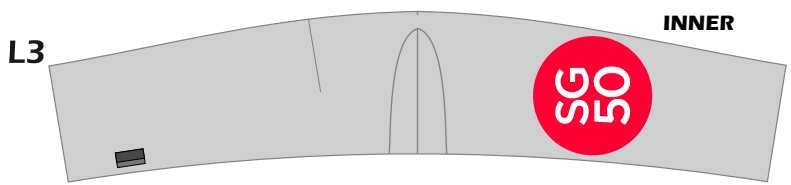
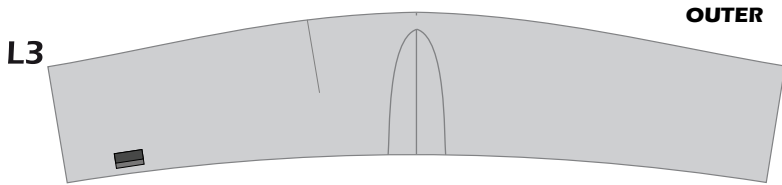
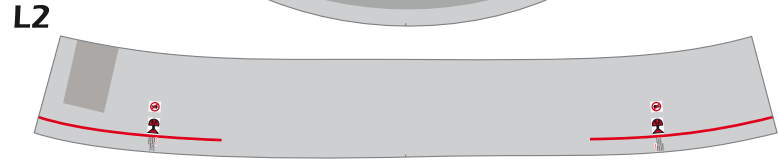
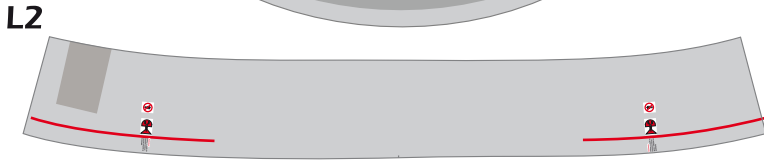
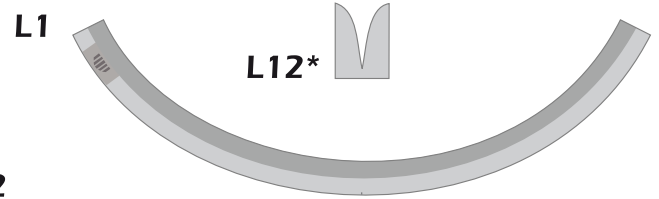
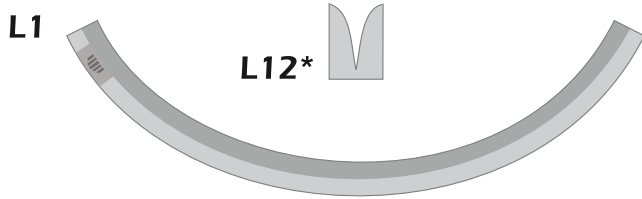
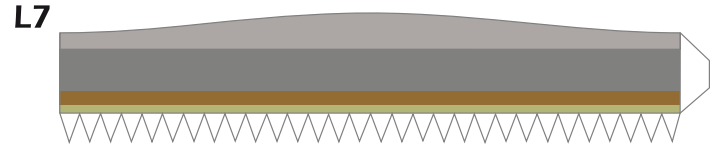
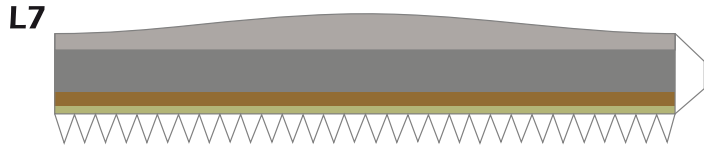
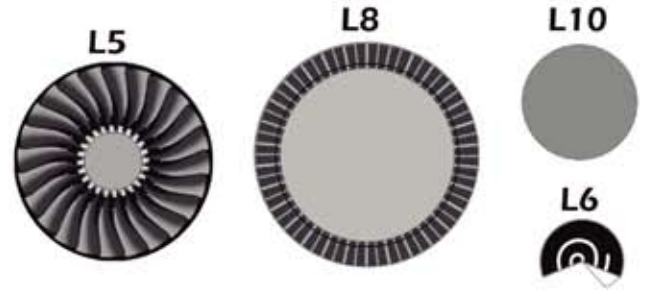
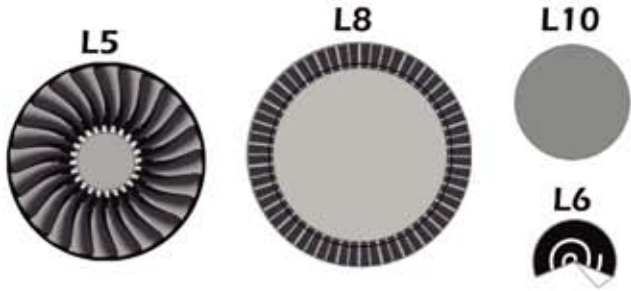

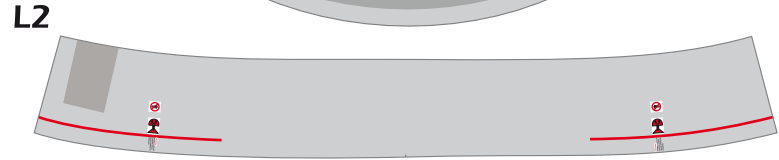
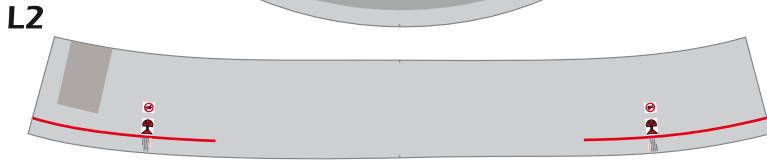
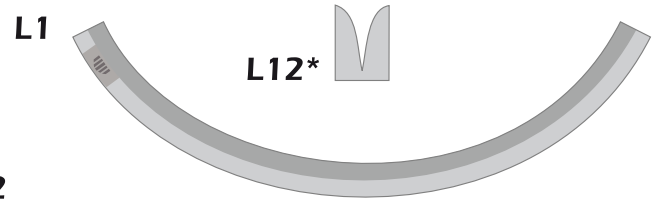
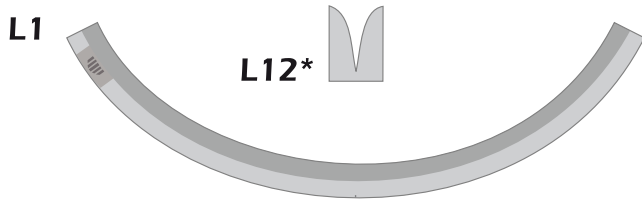
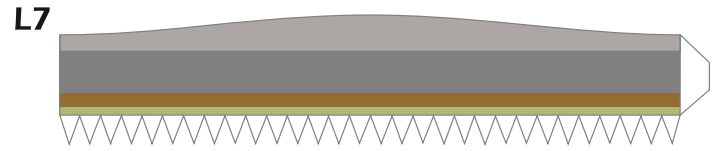
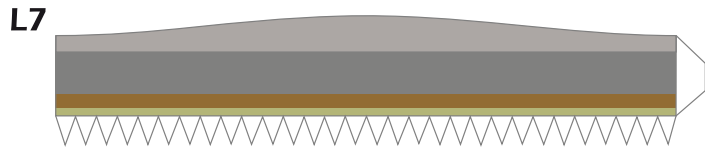
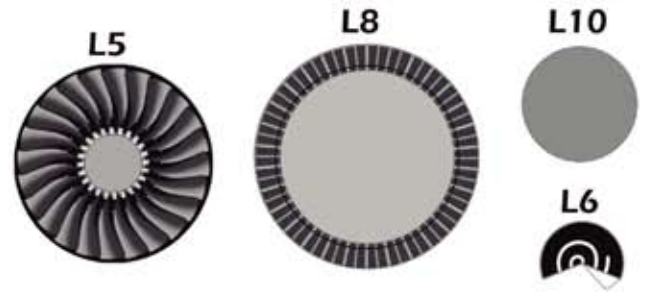
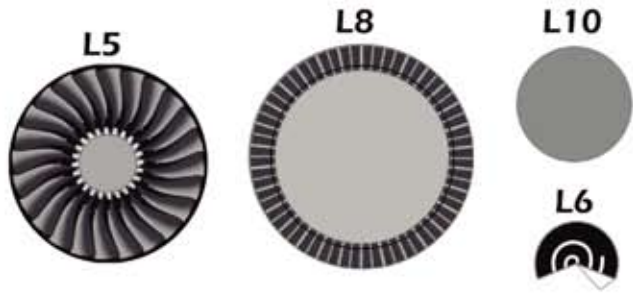

INNER

OUTER

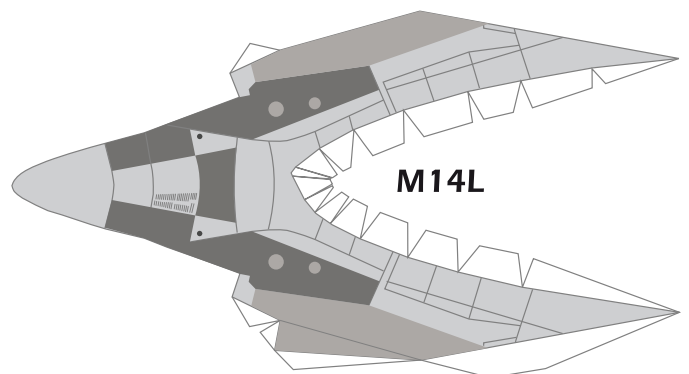
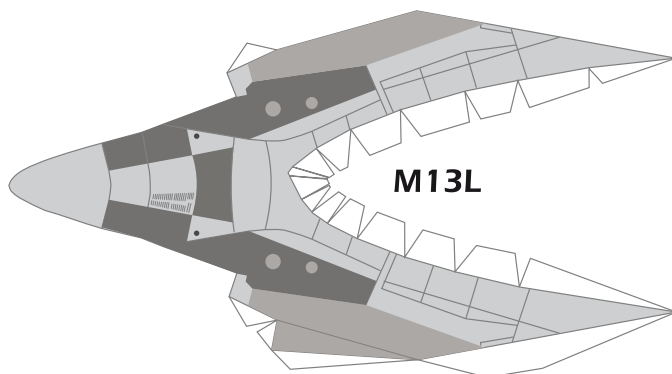
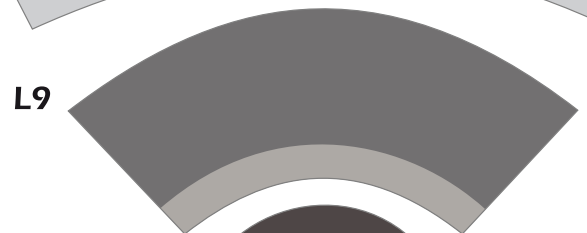
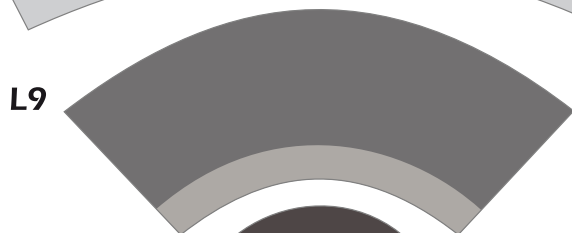
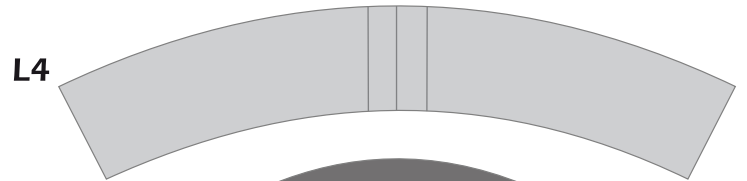
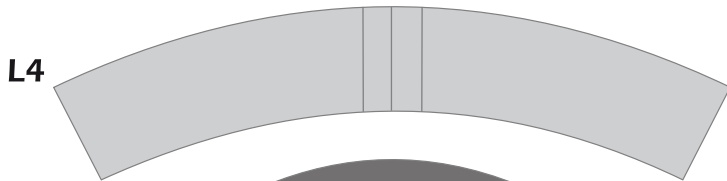
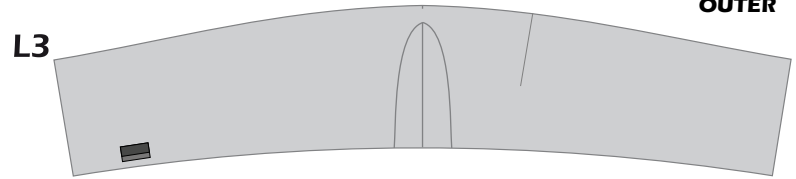
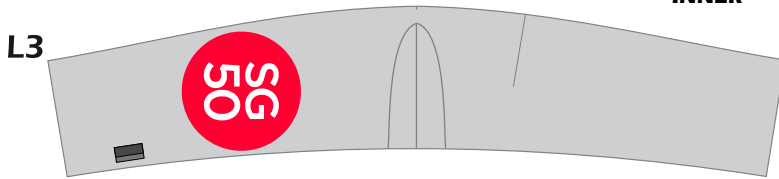

N1*

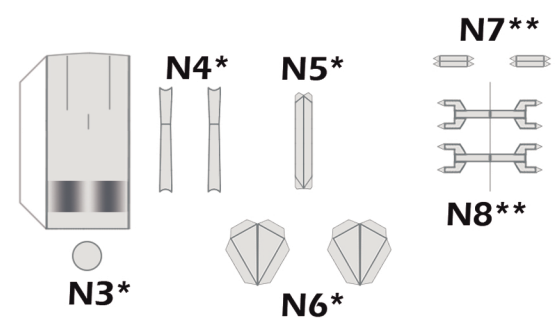
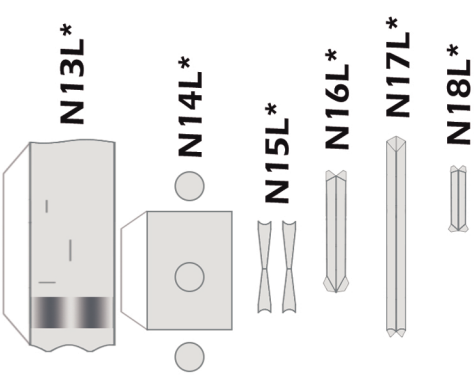
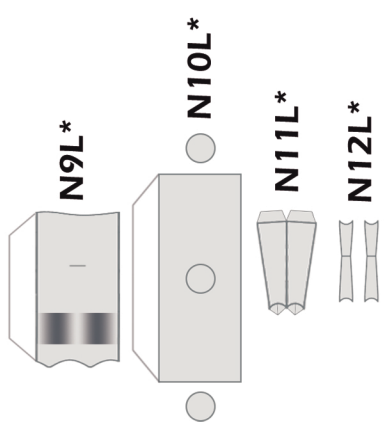
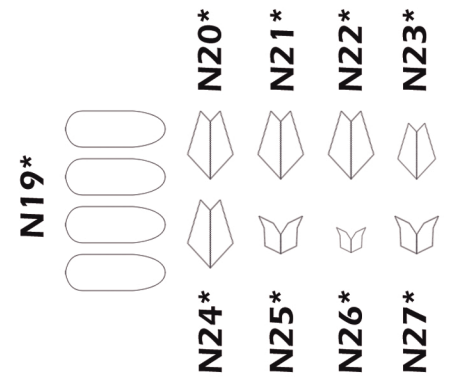
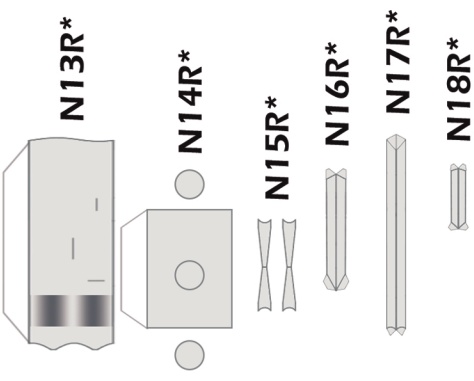
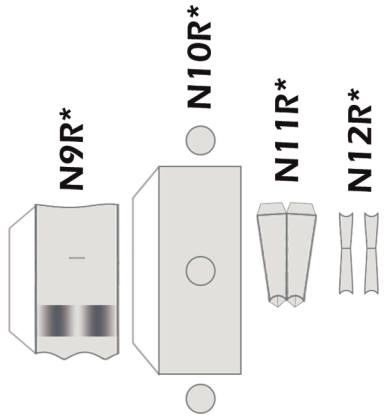
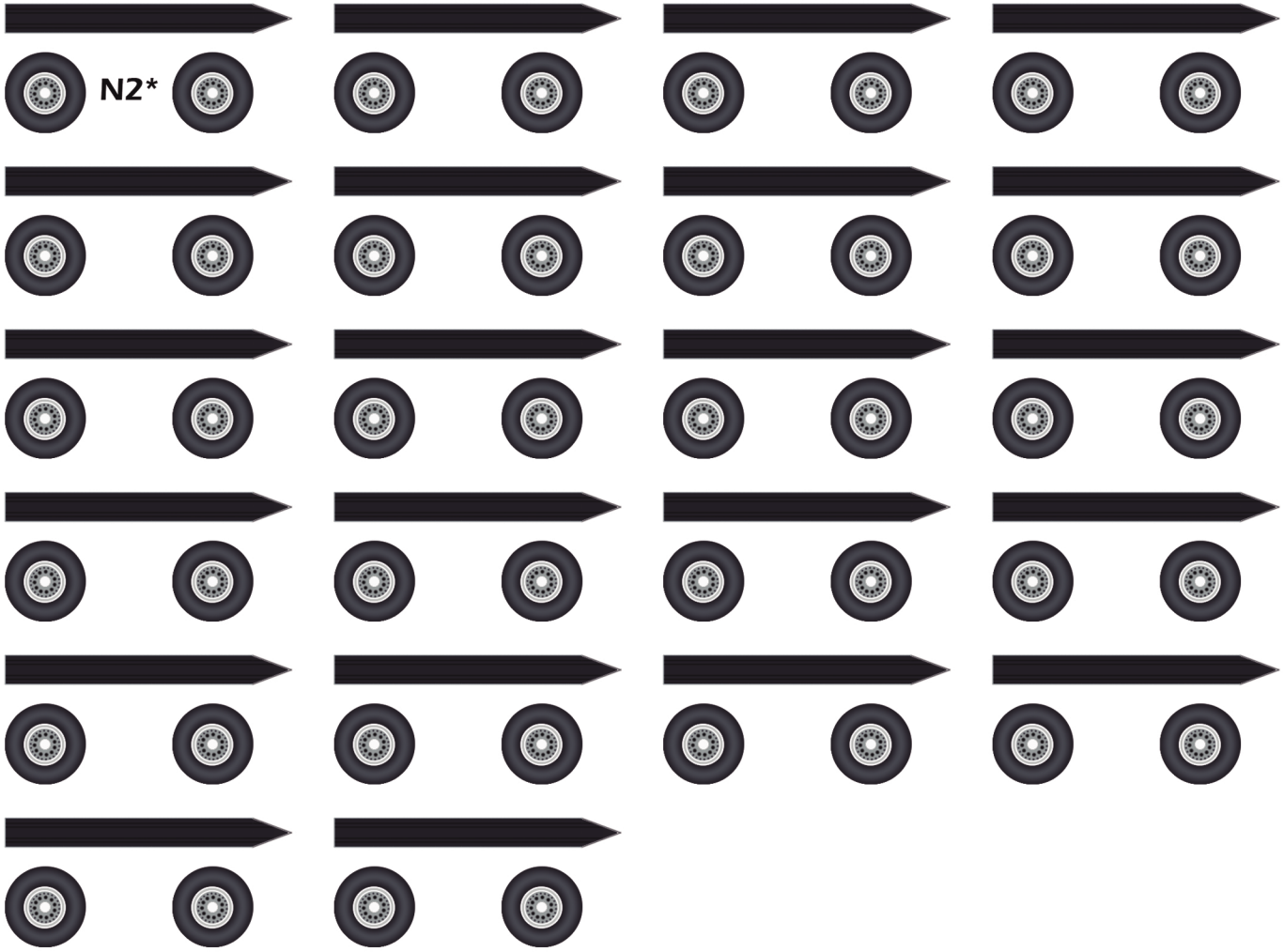

O3L

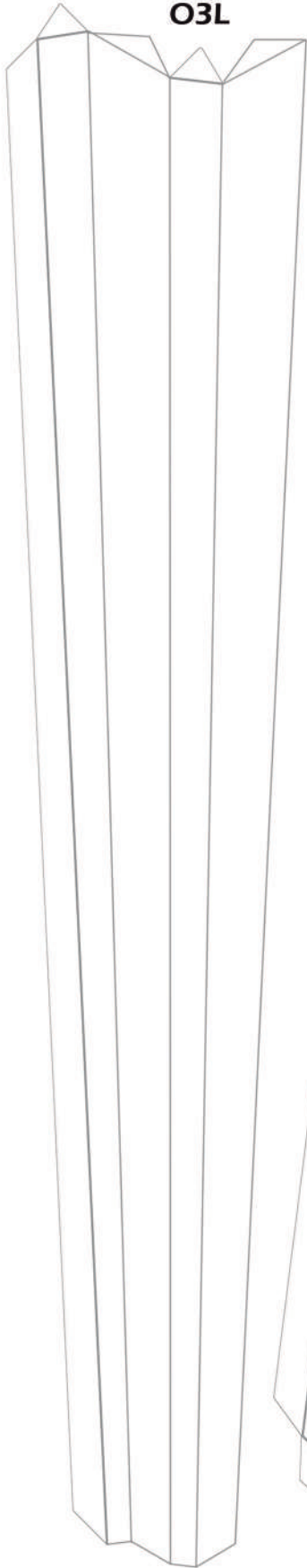

O1

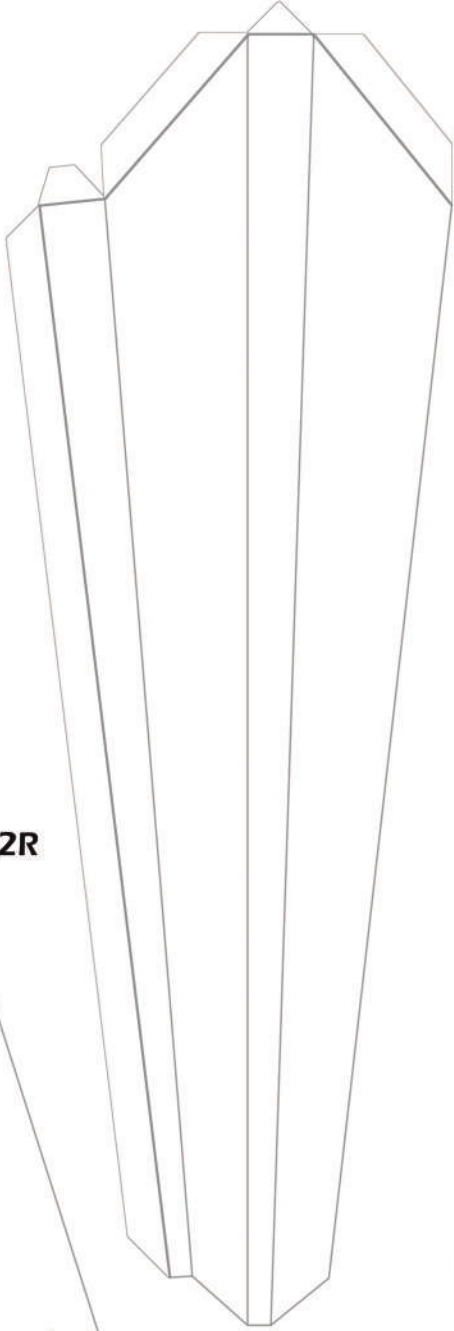

O2R

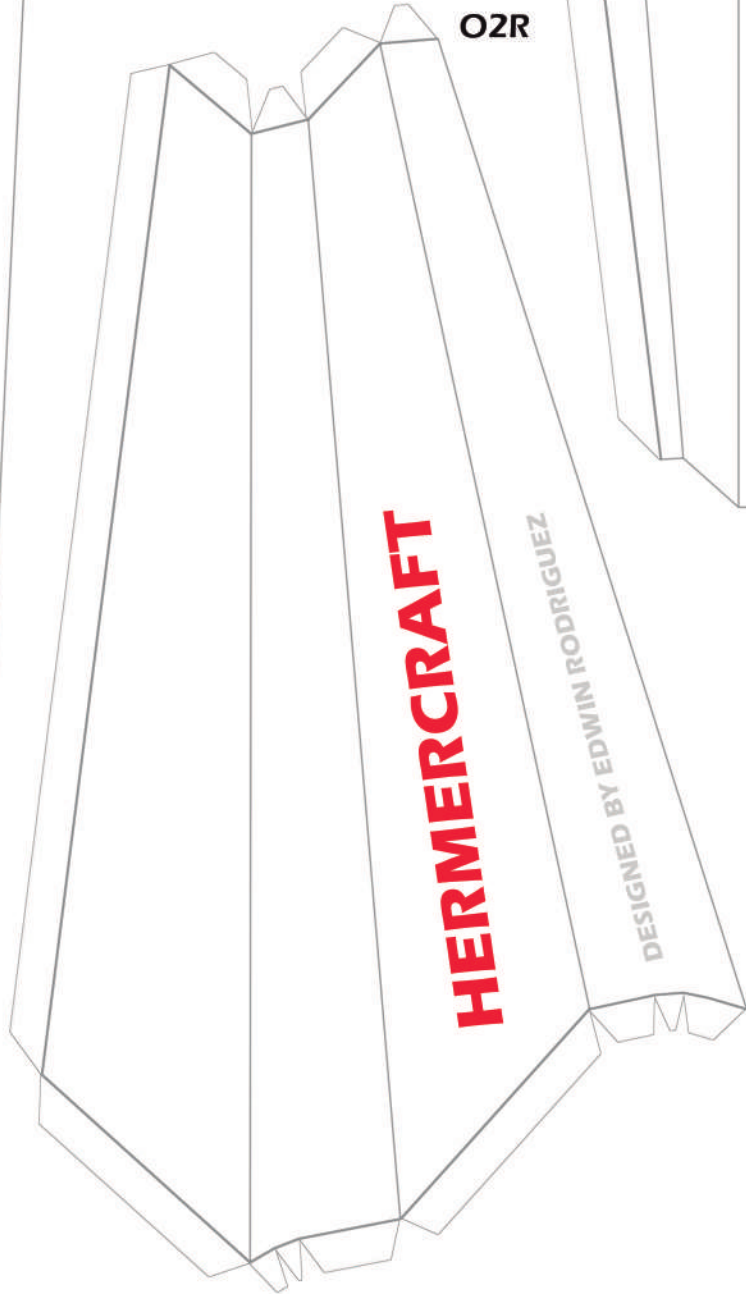

O3R

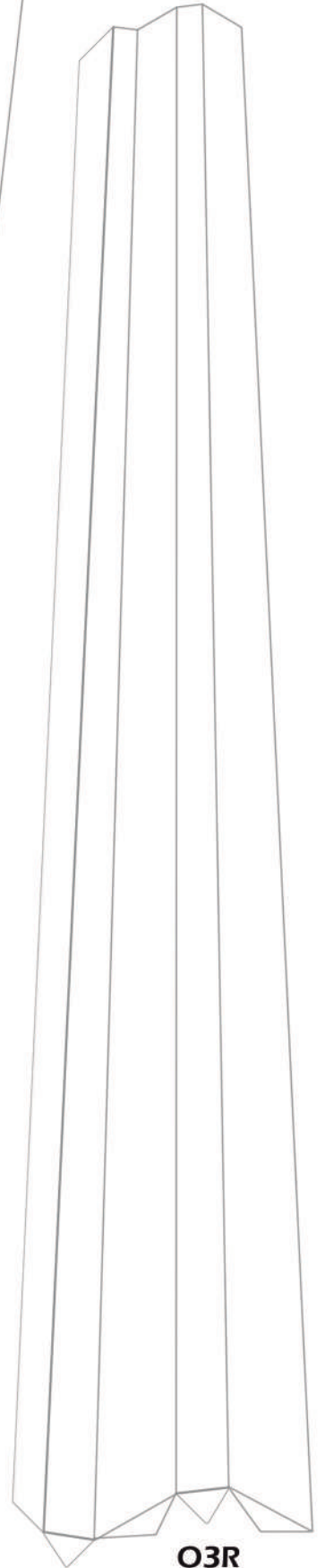

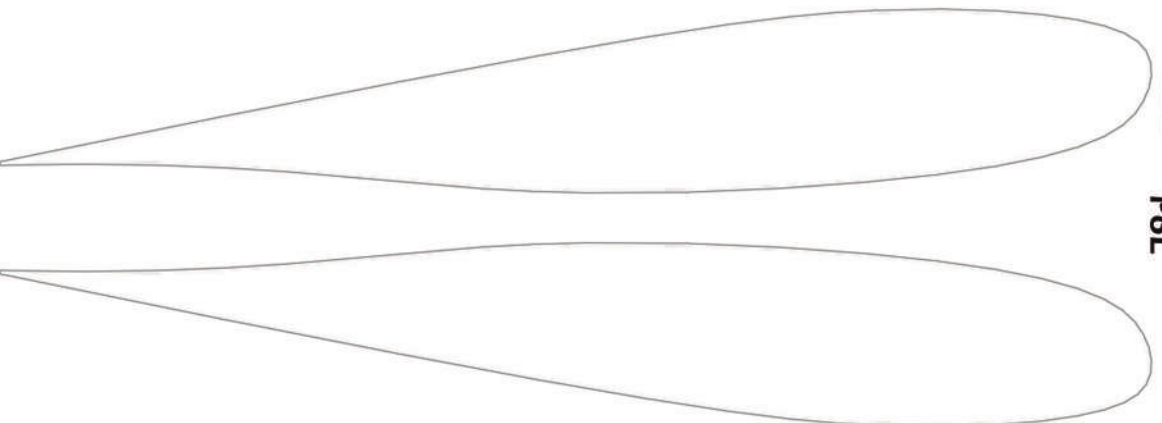
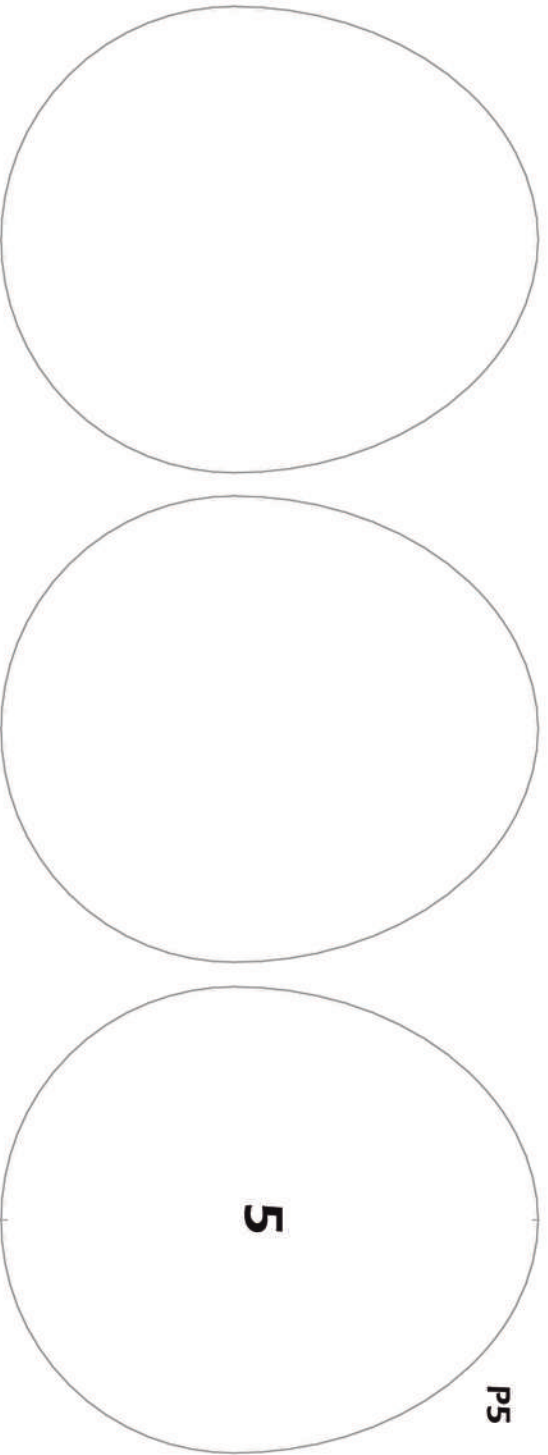
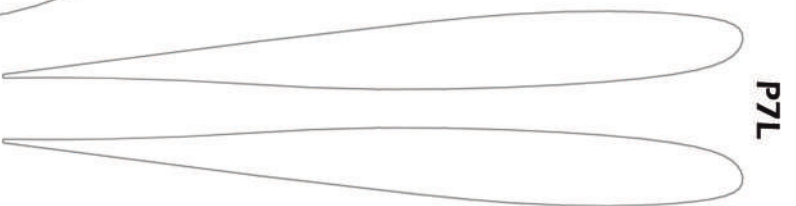
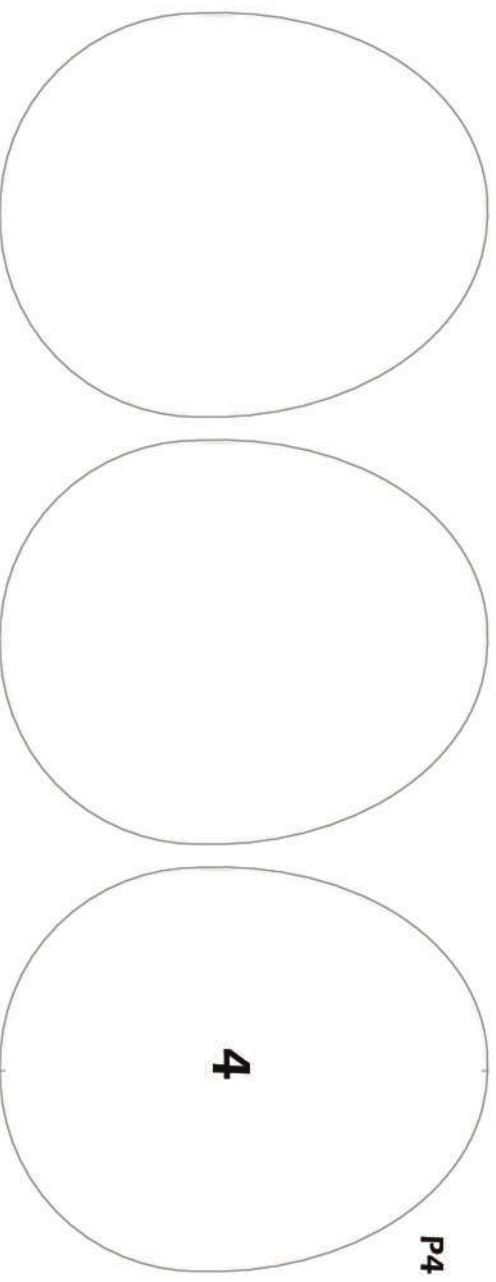
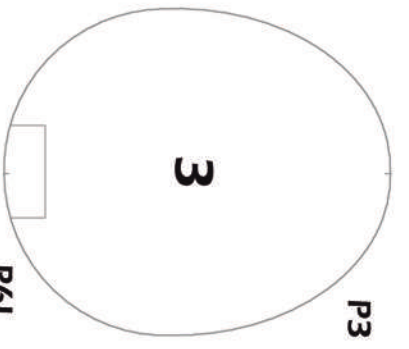
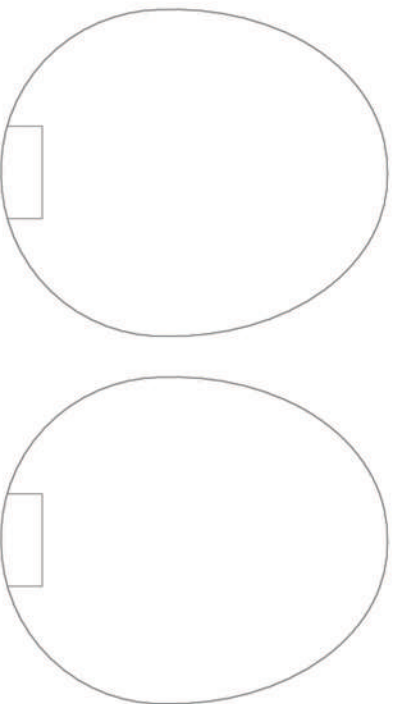
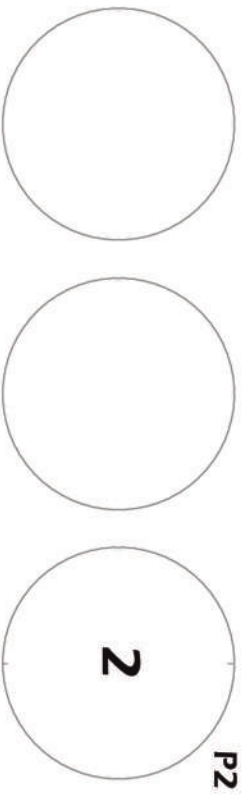
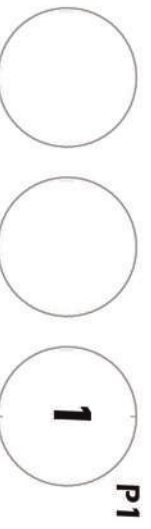

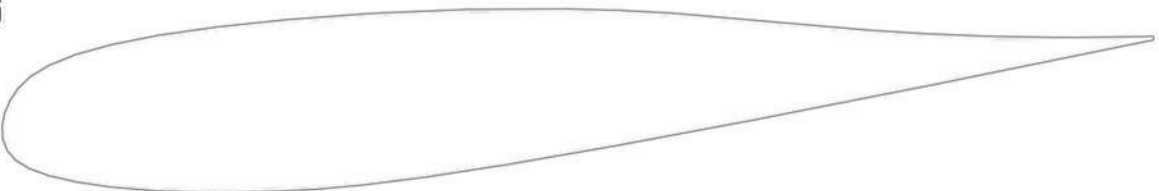
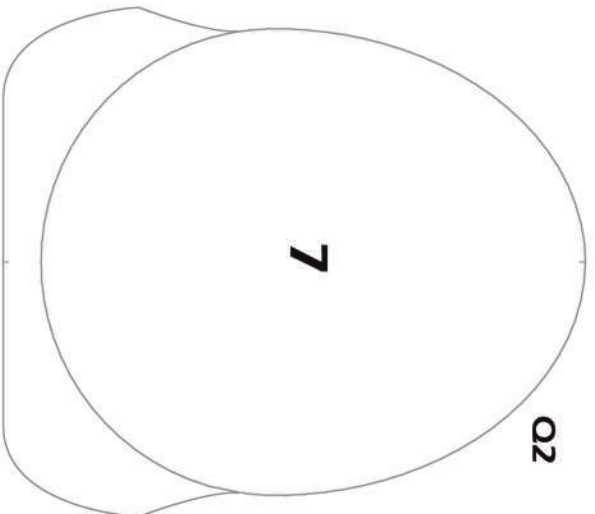
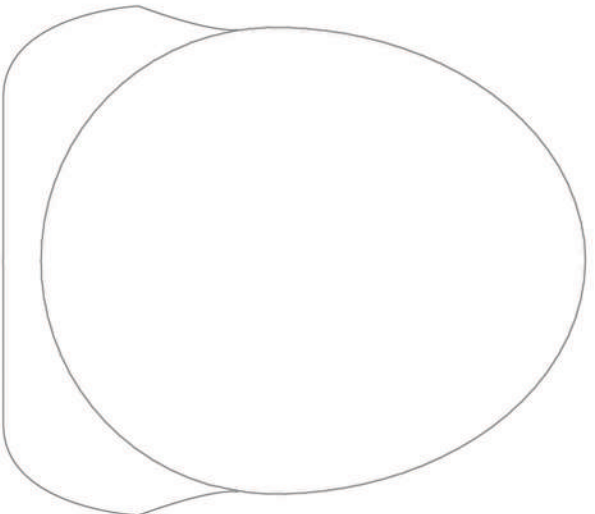
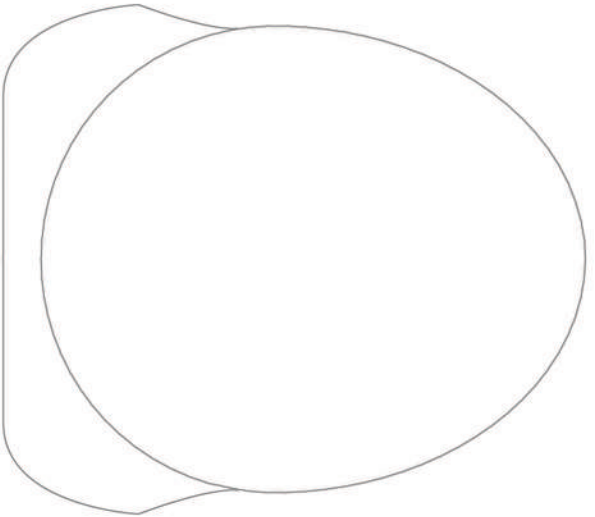
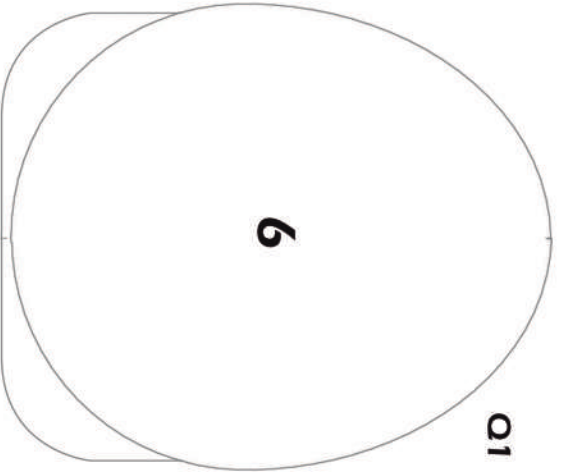
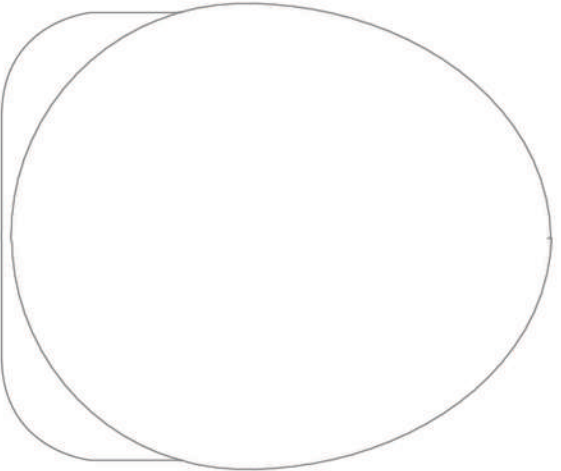
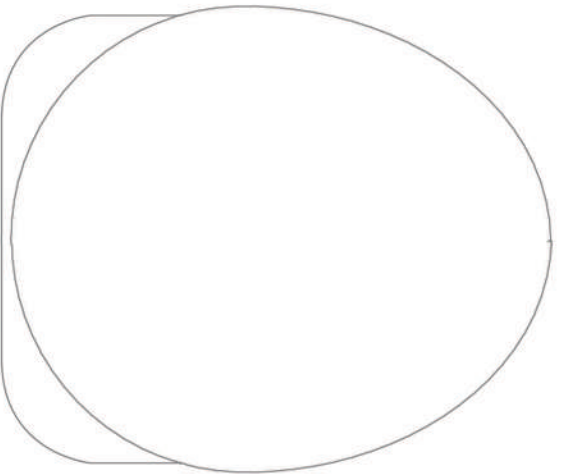

Q5R

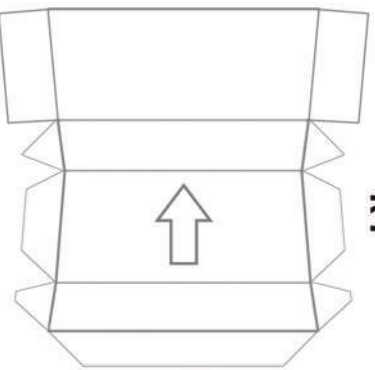
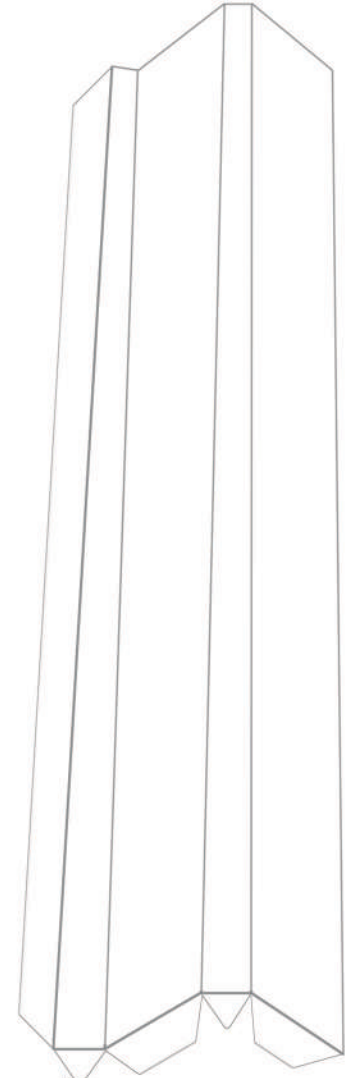
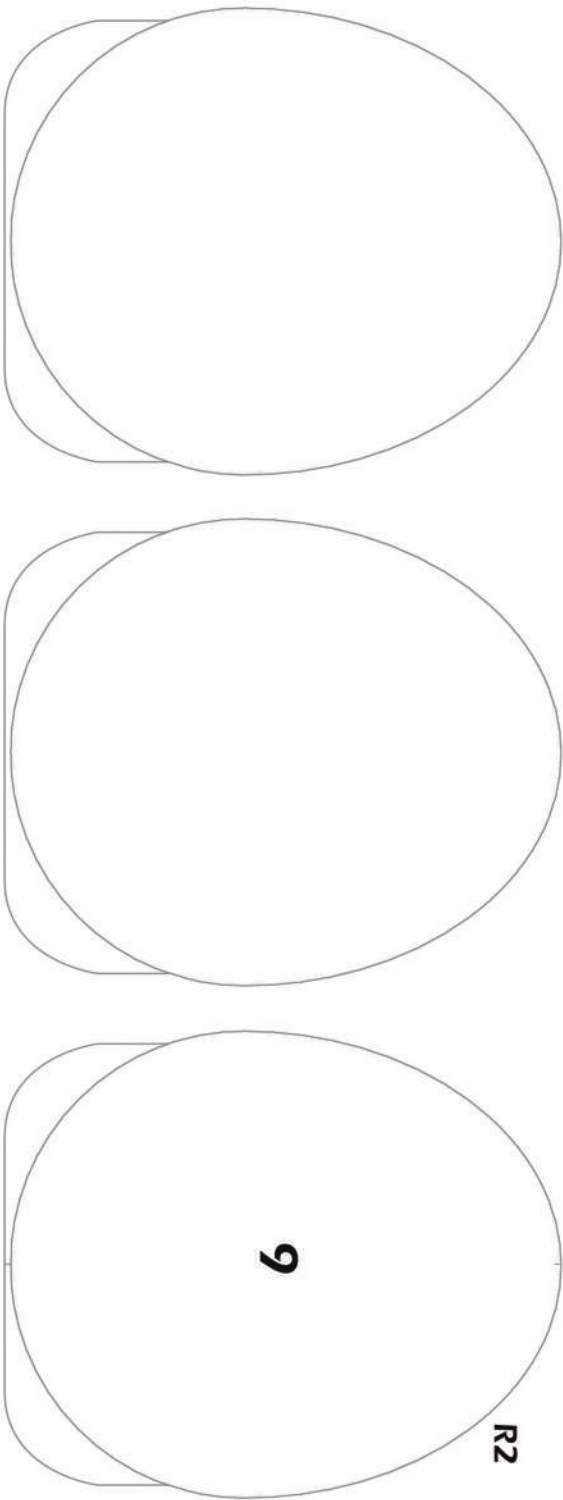
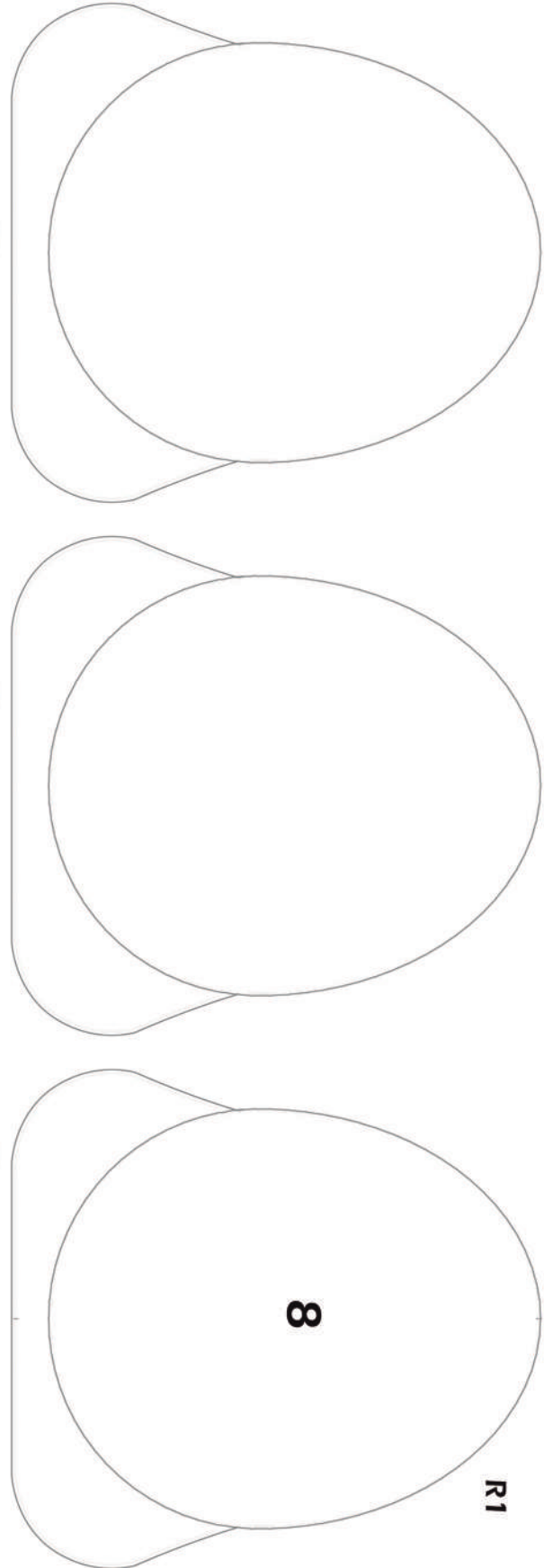

R5L

R5R

R4

9

R2

8

R1

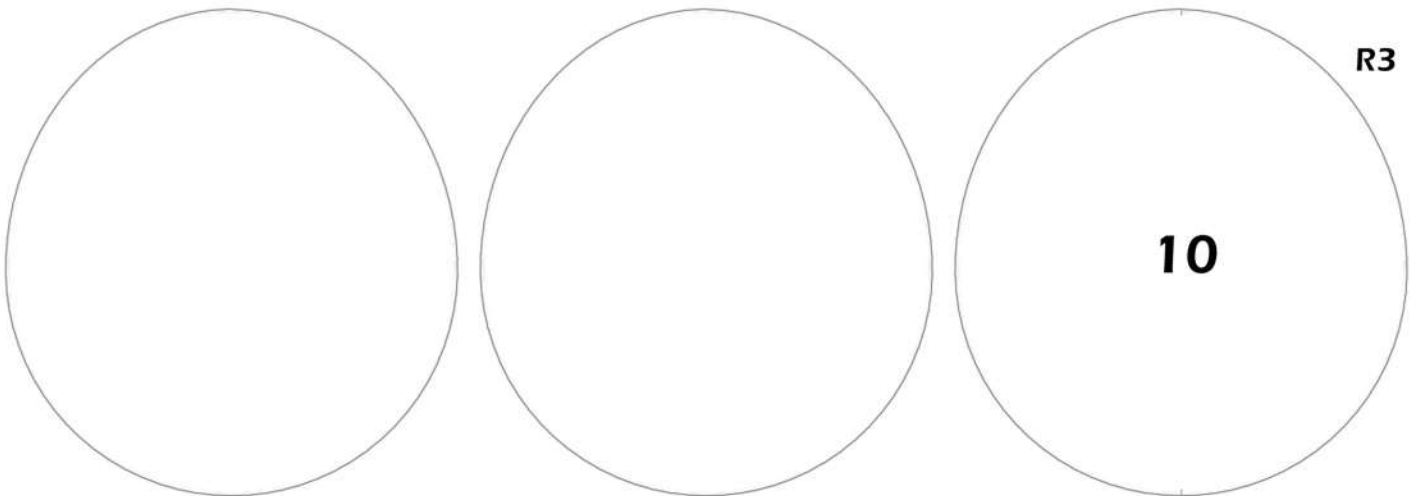

R3

10

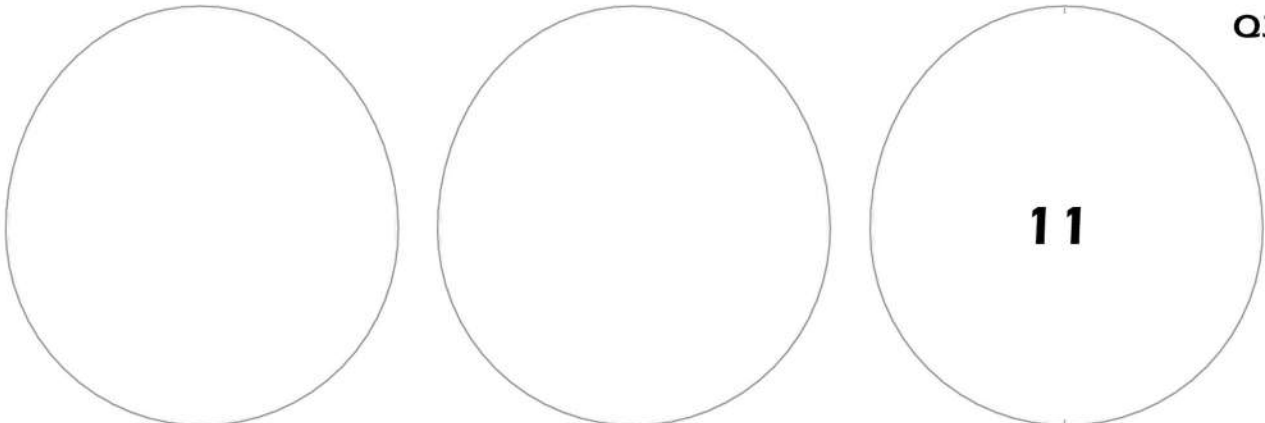

Q3

11

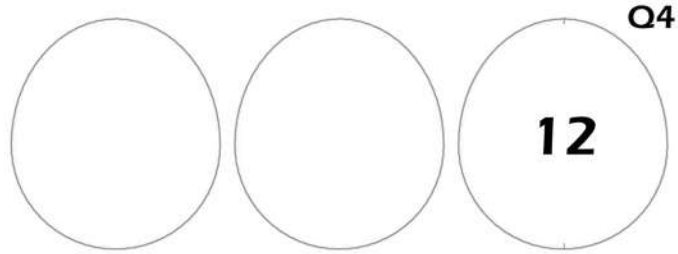

Q4

12

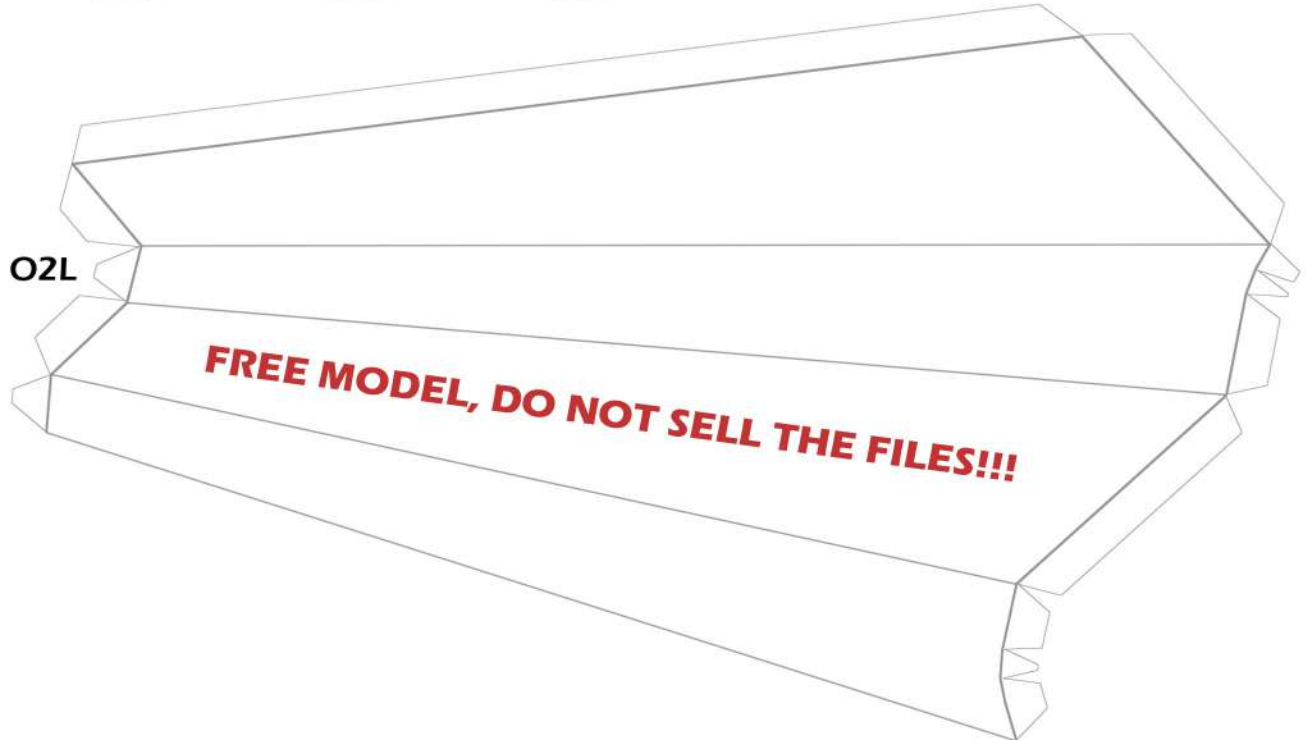

O2L

FREE MODEL, DO NOT SELL THE FILES!!!

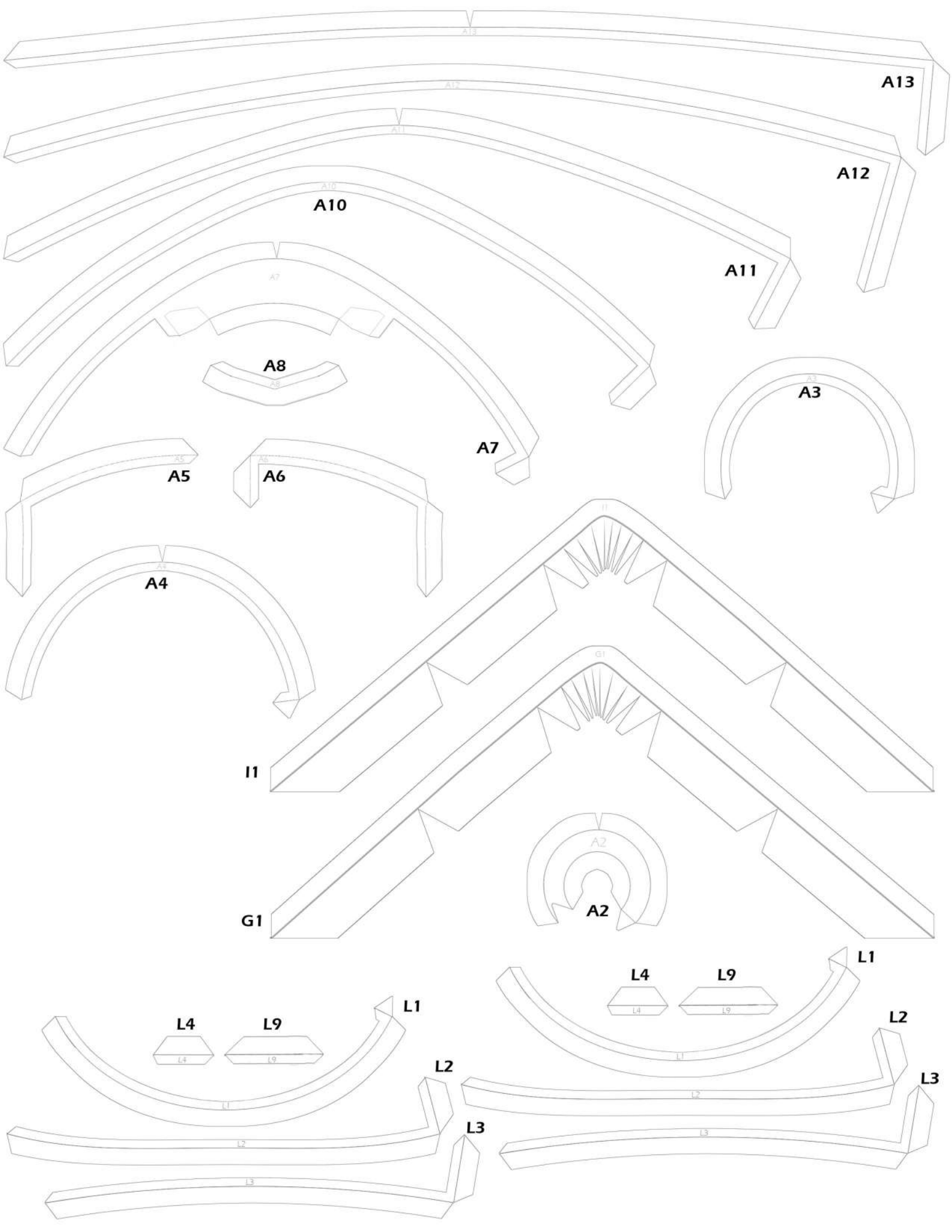

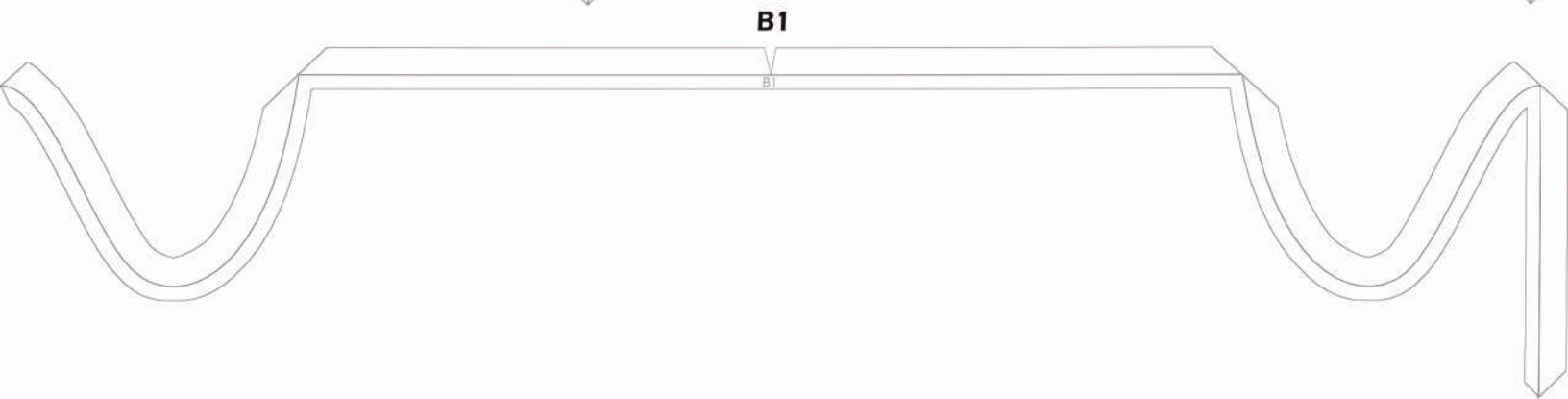
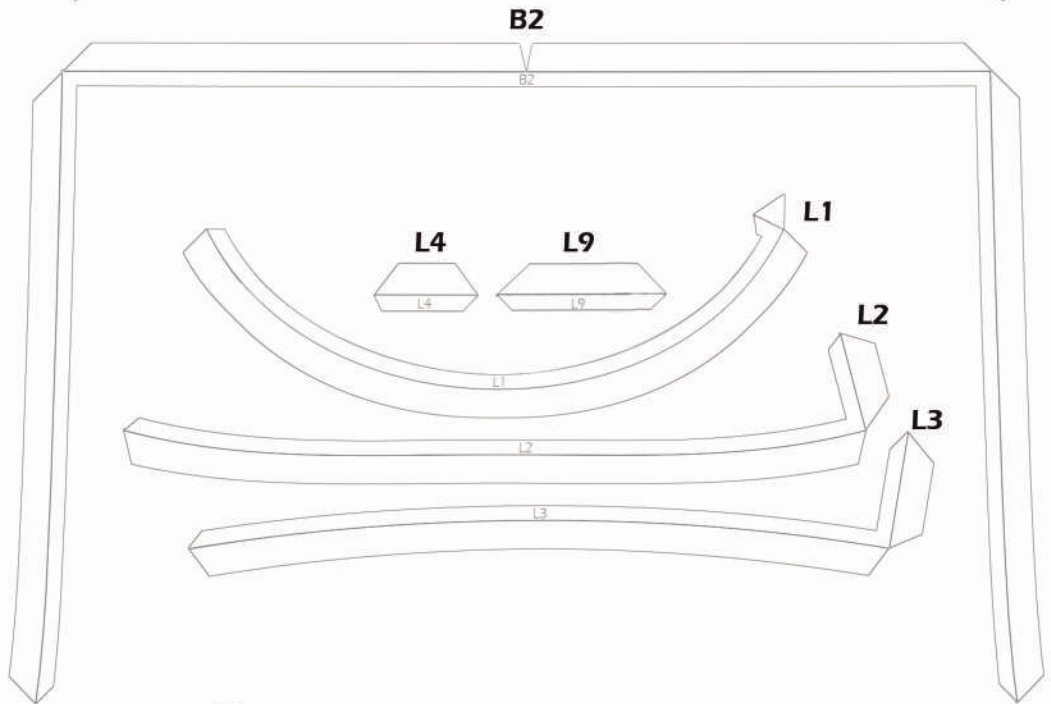
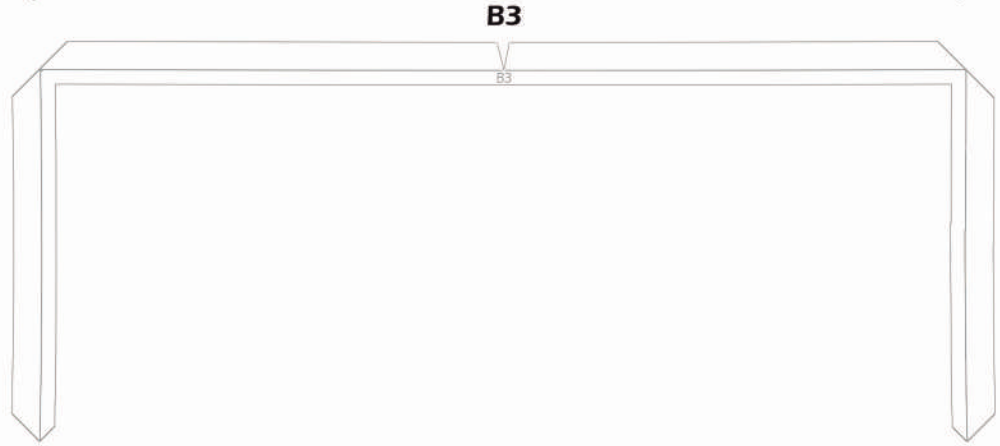
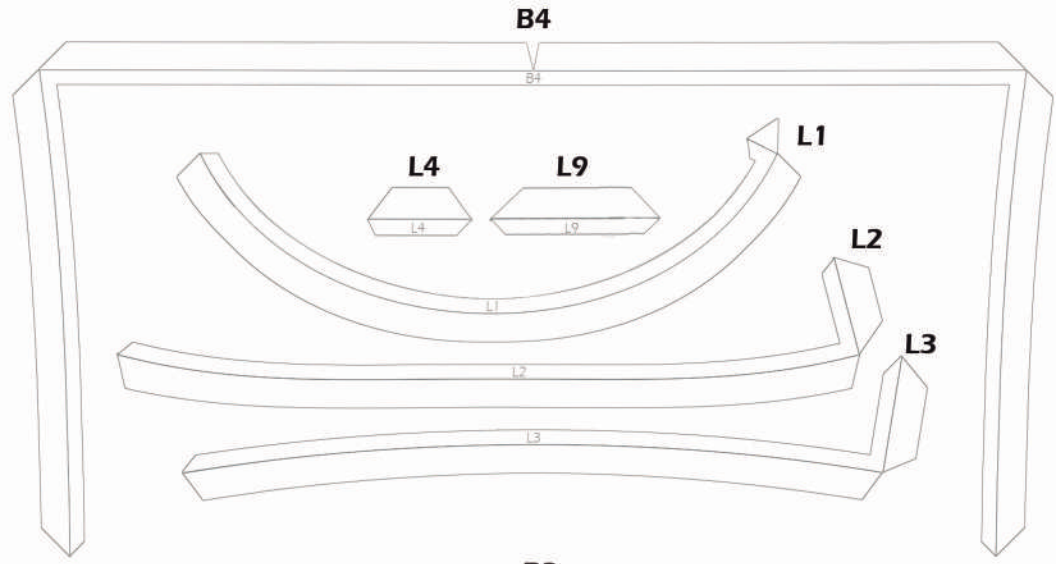
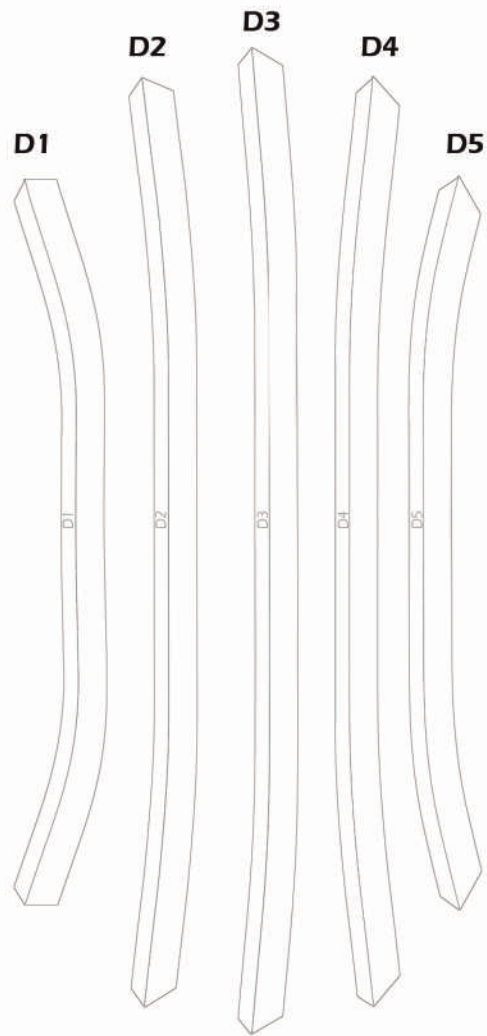

K15L K16L

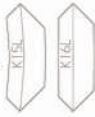

K11L K12L



K7L K8L



K4L K5L



K1L K2L



C7

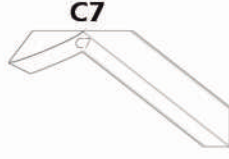

C6

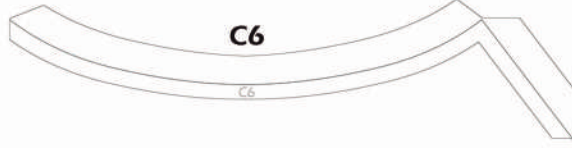

C5

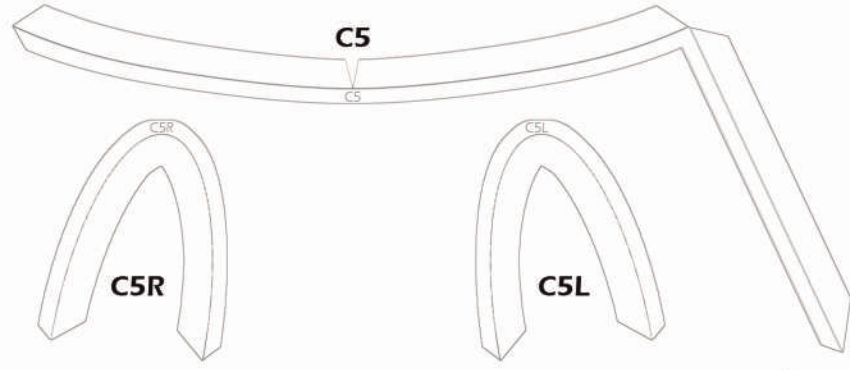

C5R

C5L

C4

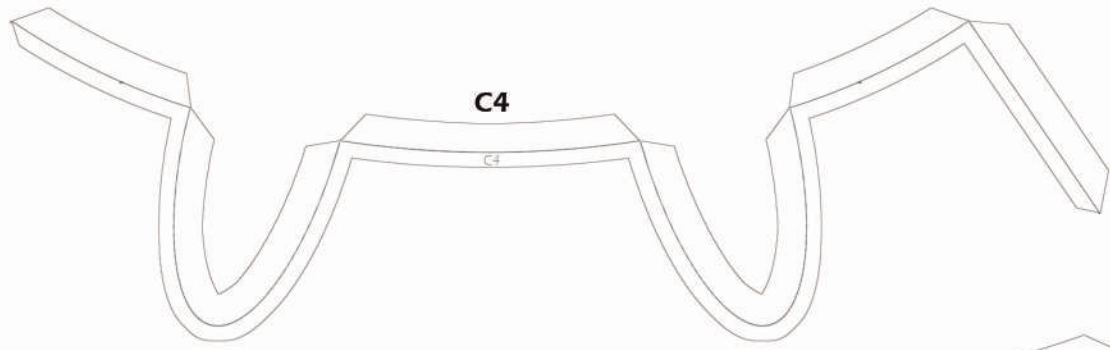

C3

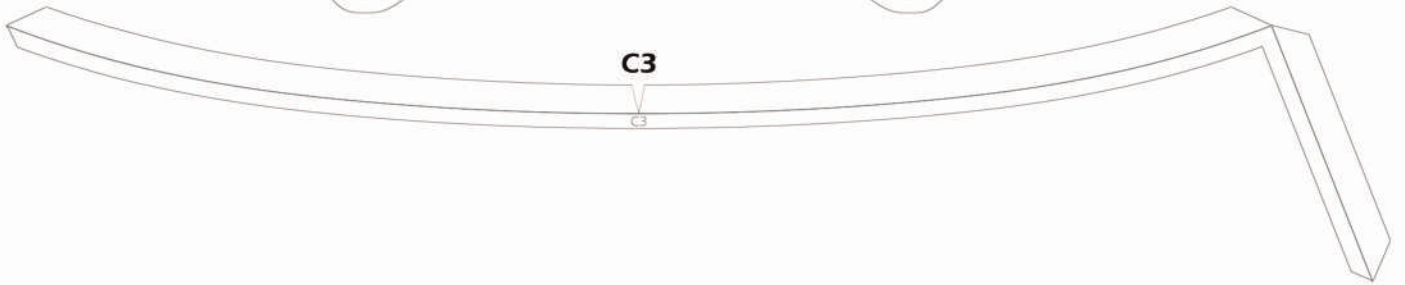

C2

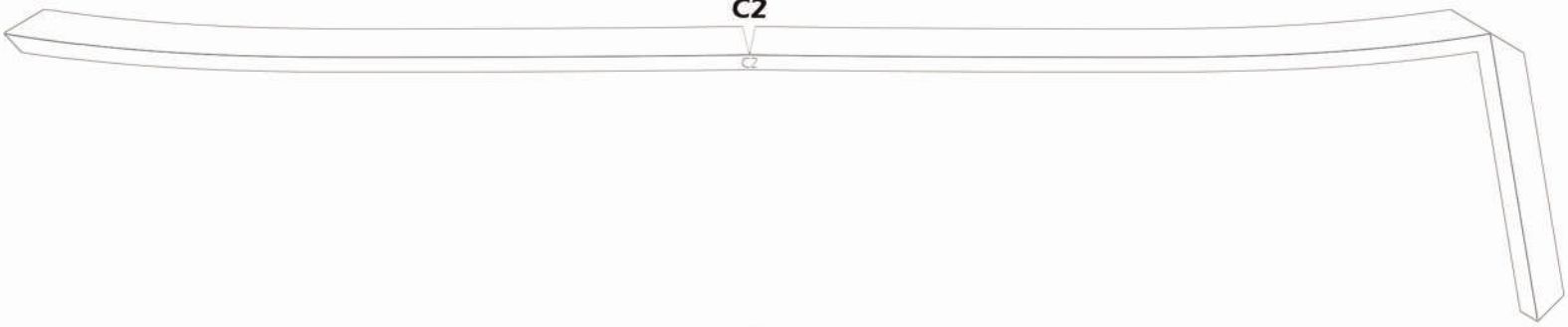

C1

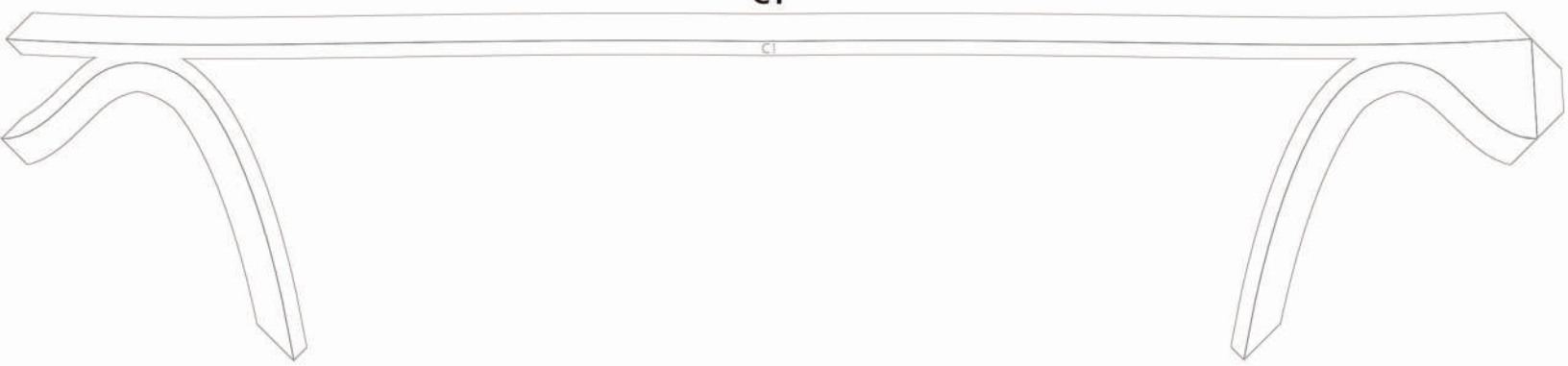

K1R K2R



K4R K5R



K7R K8R



K11R K12R



K15R K16R

