

Blank space for 787-10 variant

Instructions



Scan

A14

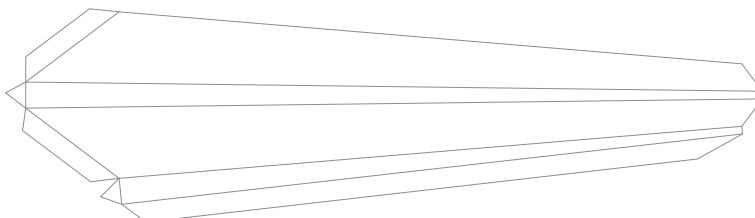

A16L

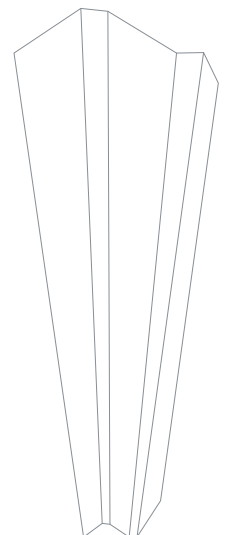

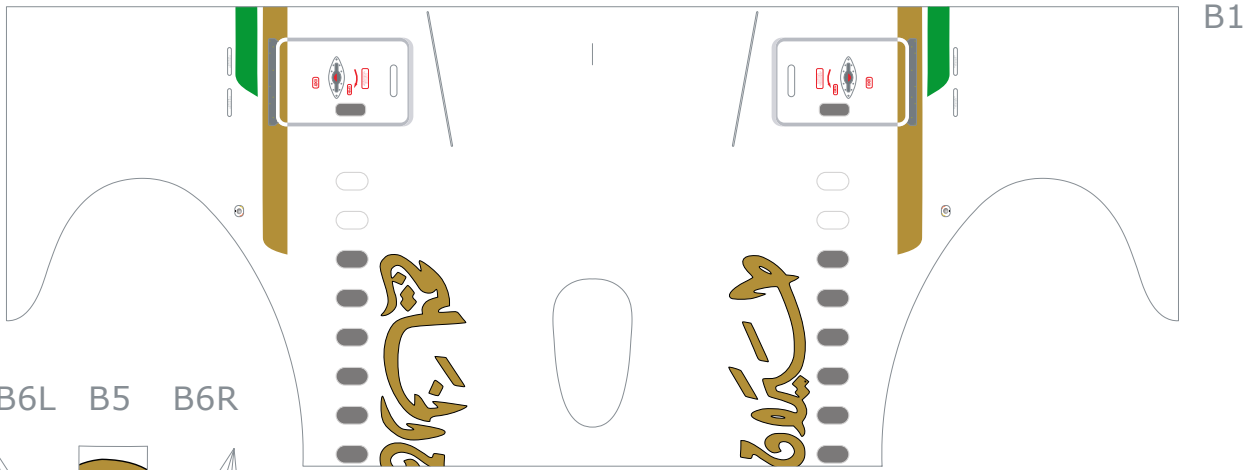

B6L B5 B6R

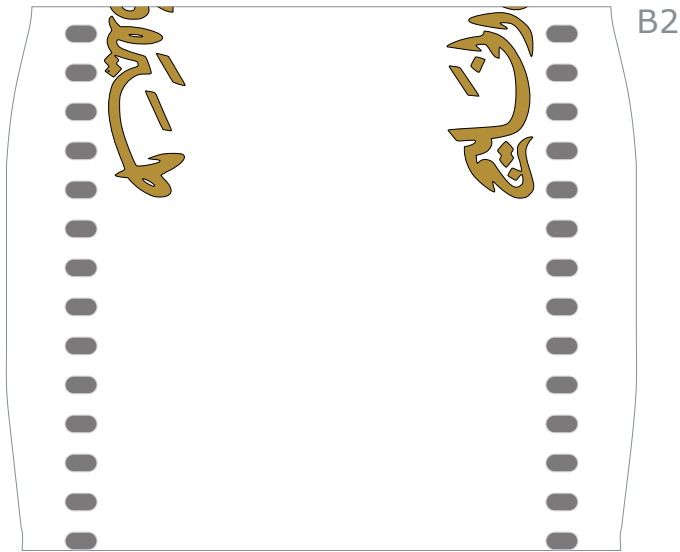

B4

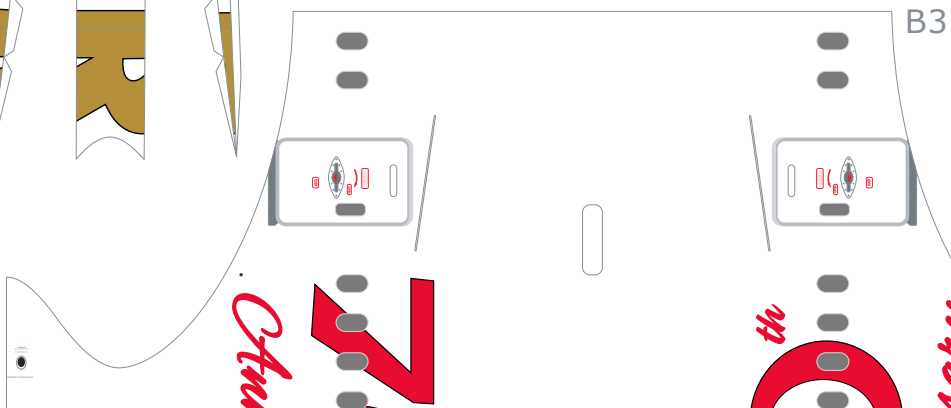
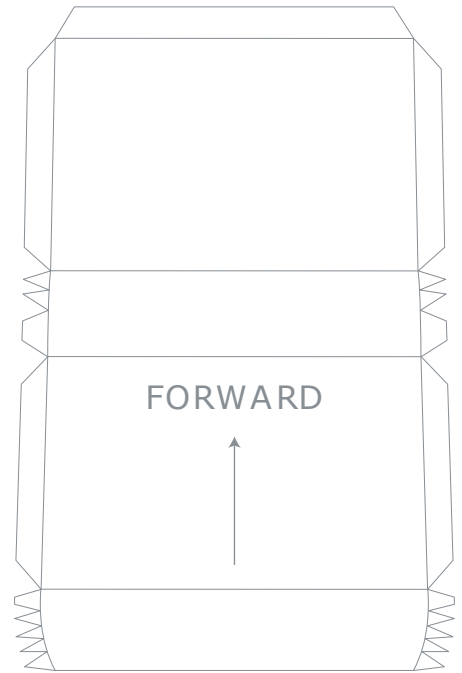



Blank space for 787-10 variant

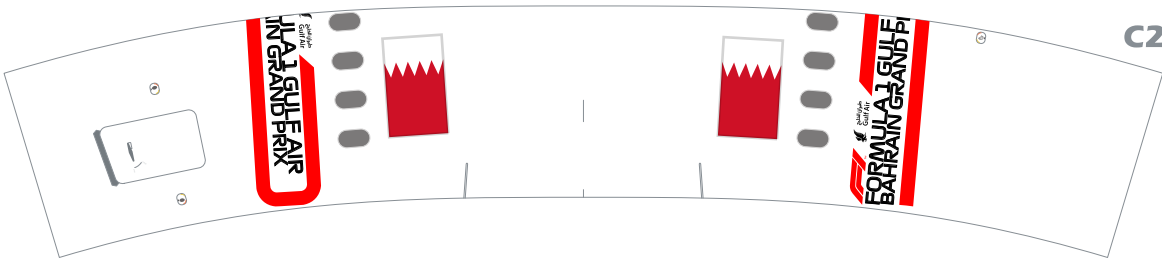
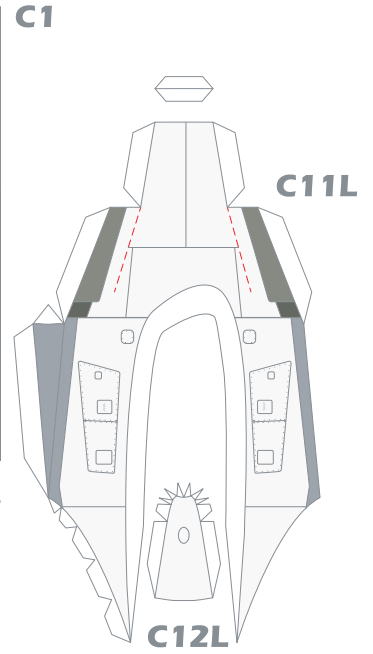

C2

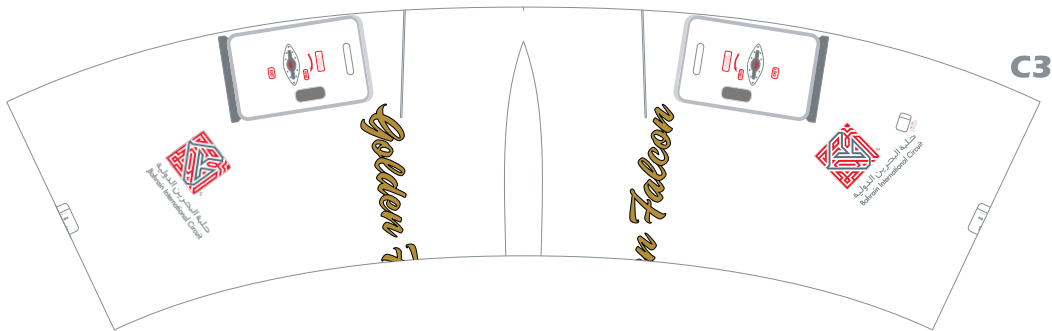
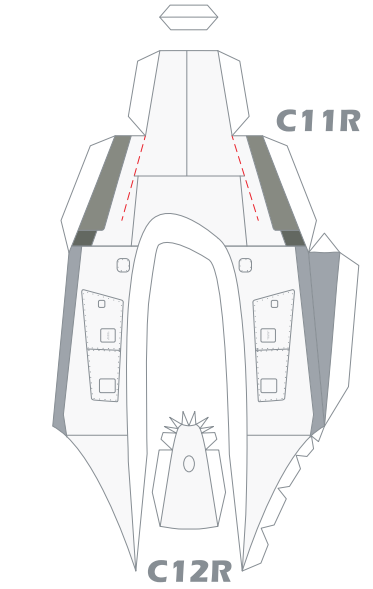

C3

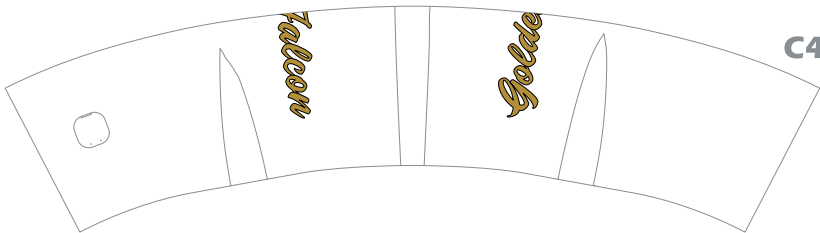

C4



C9

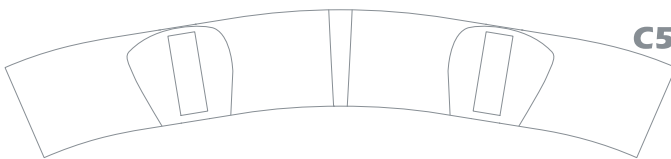
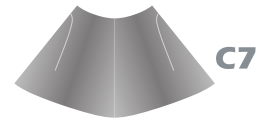

C5

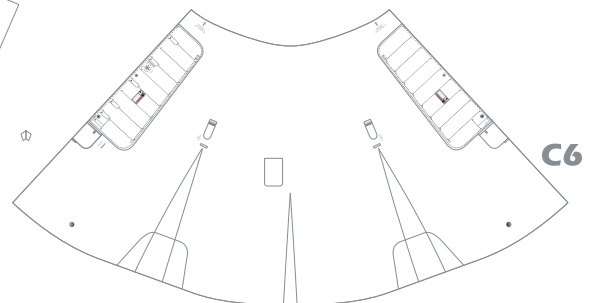

C6



C10L



C10R

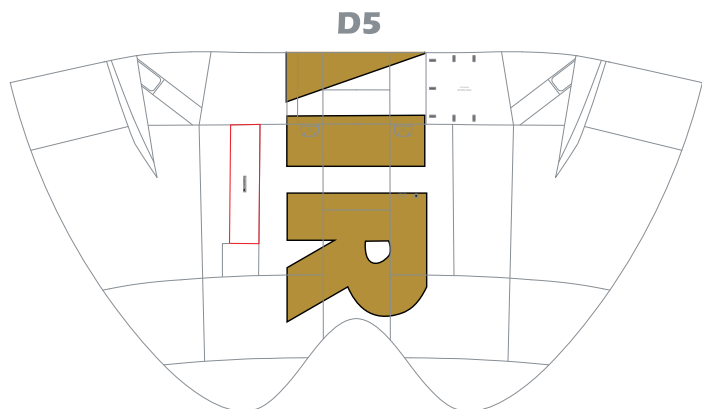
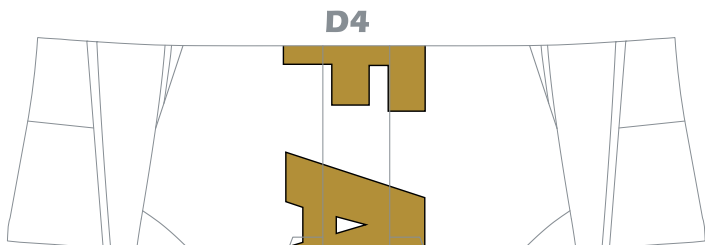
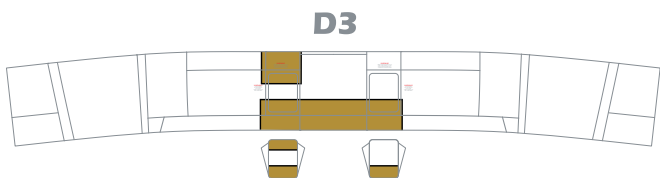
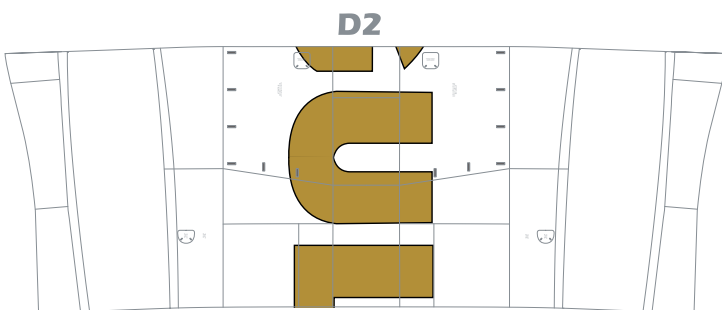
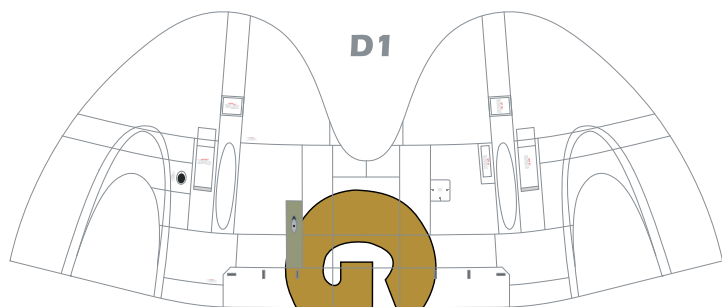

D7



D8

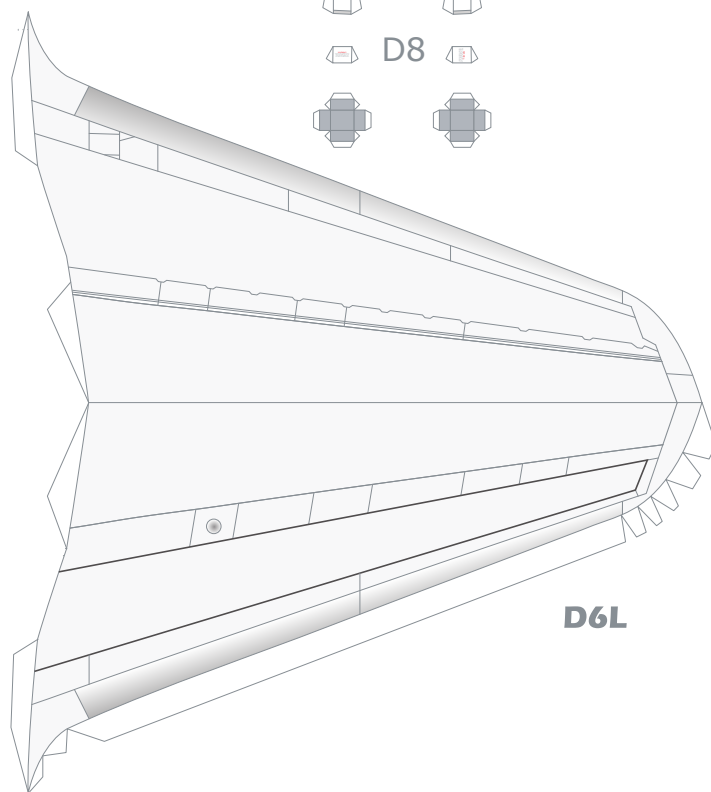

D6L

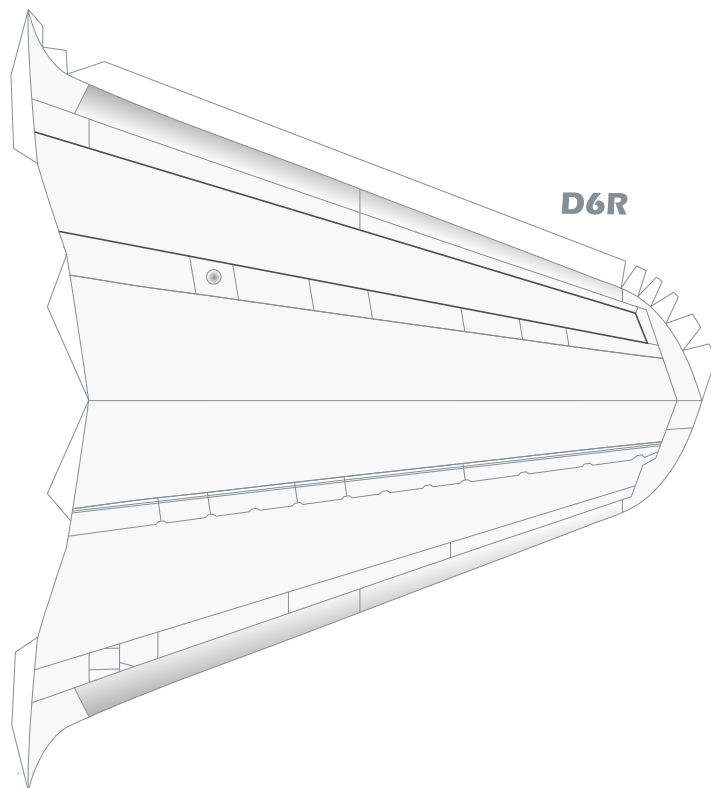

D6R

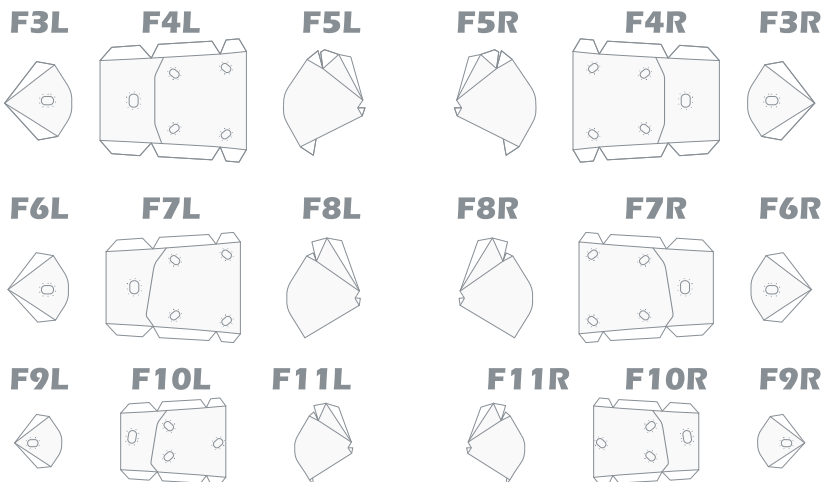
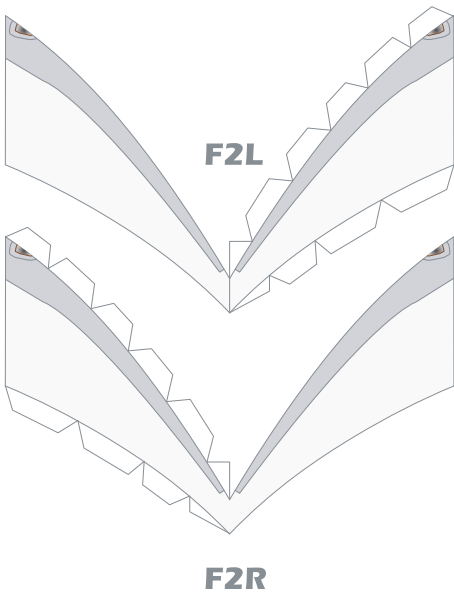
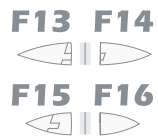
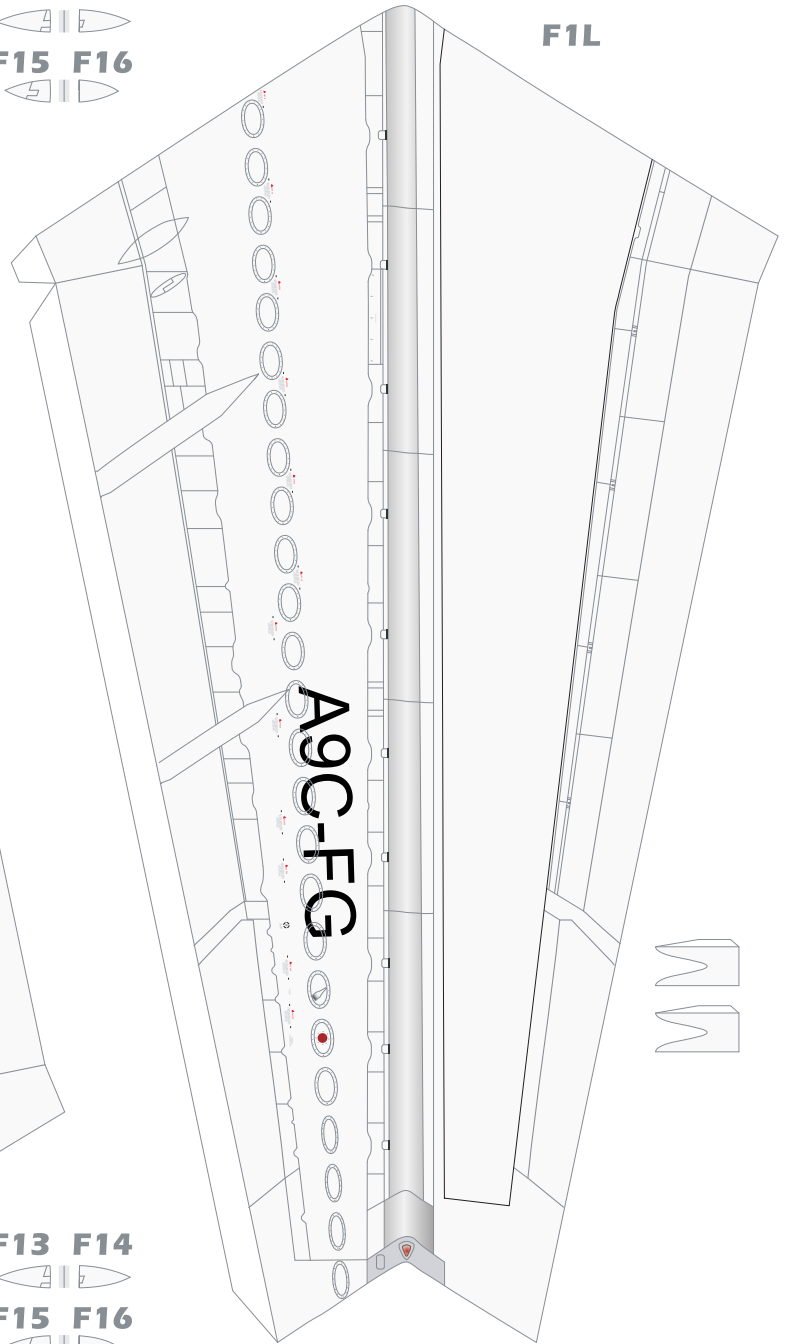
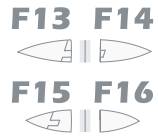
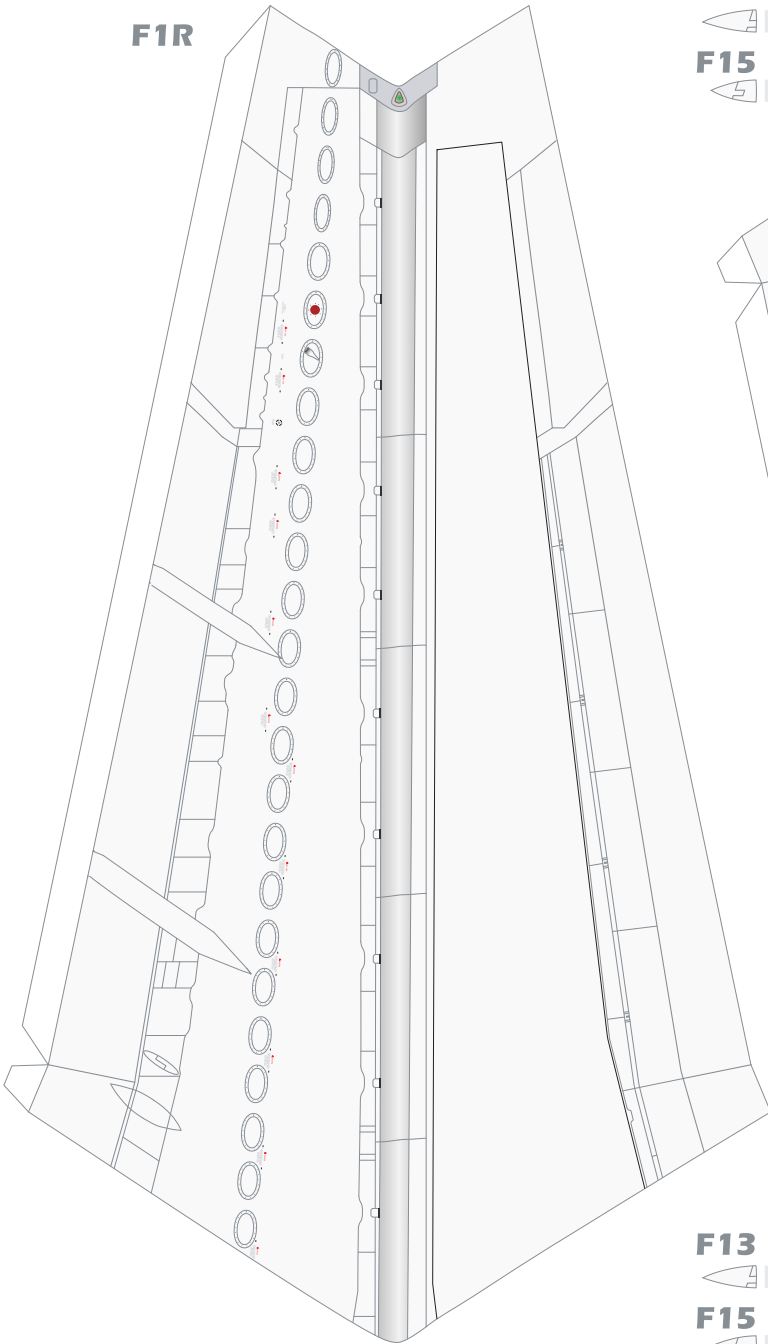

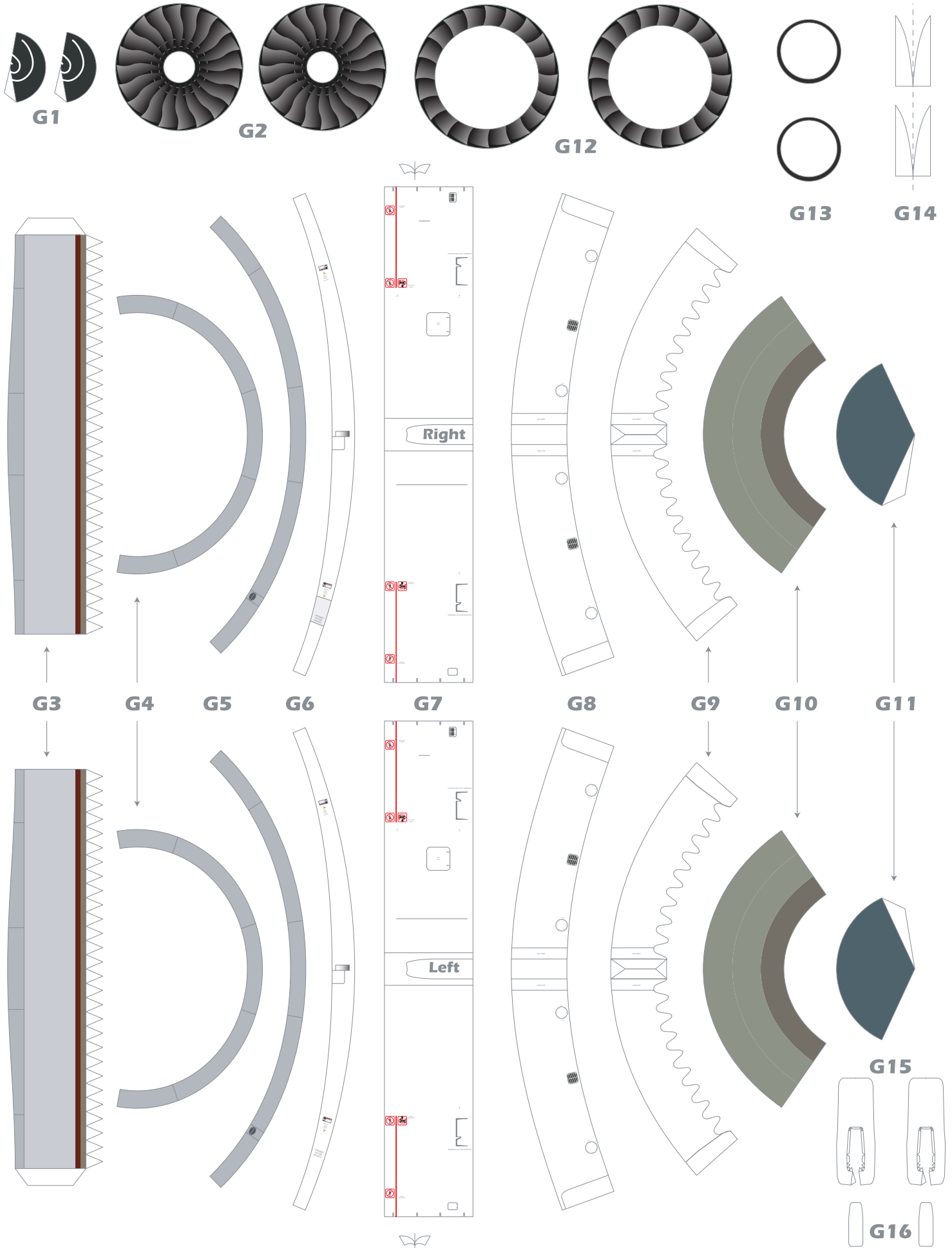

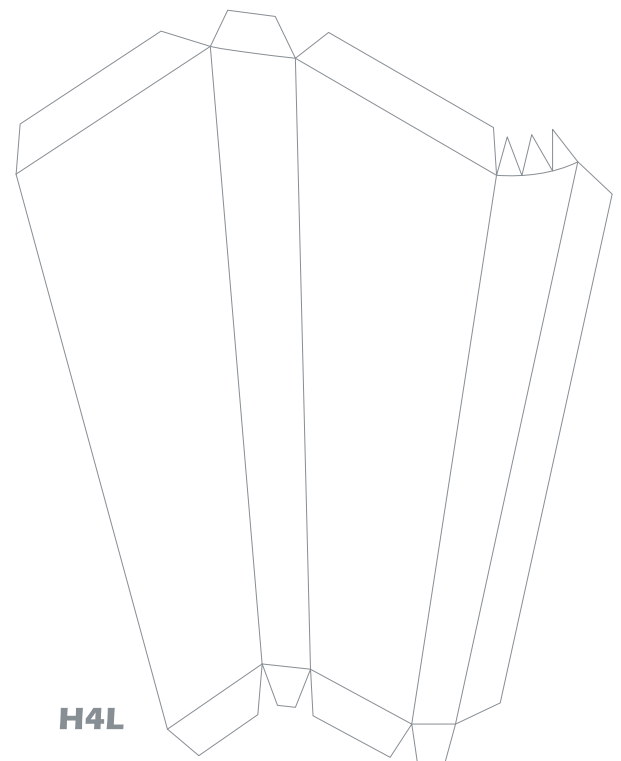
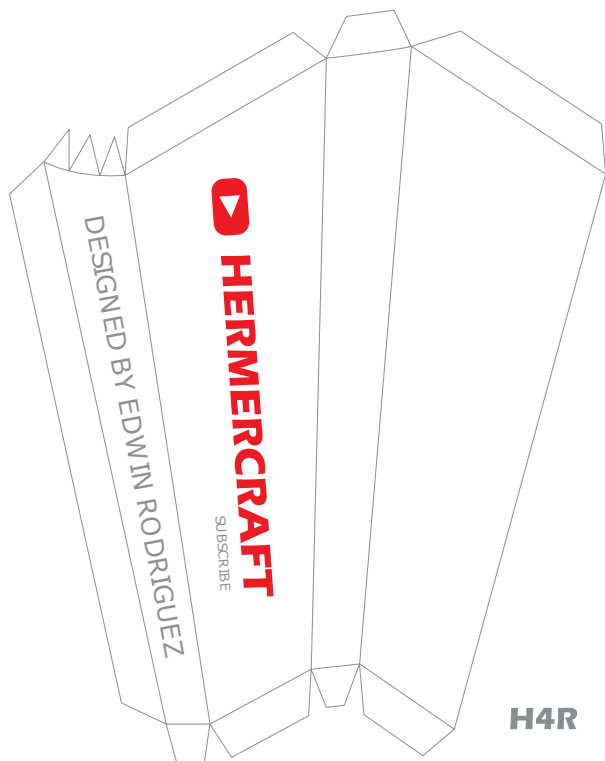
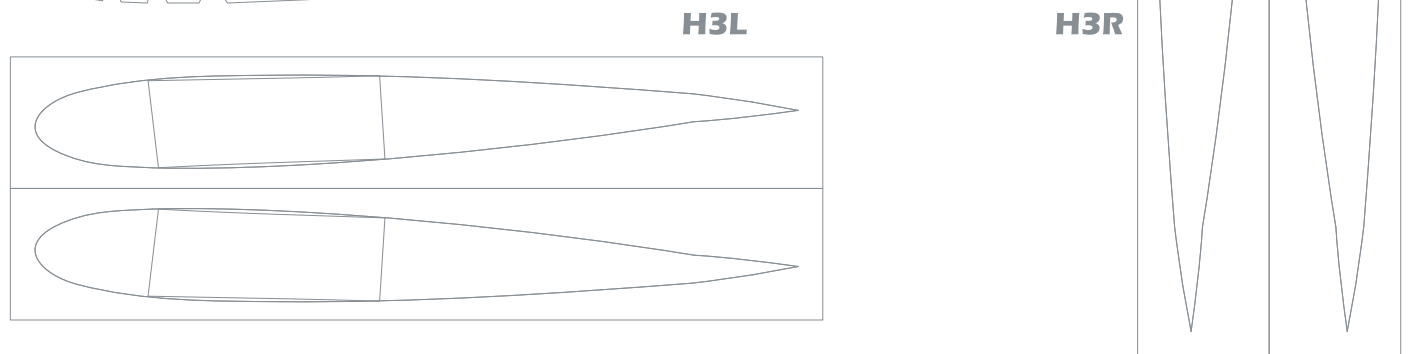
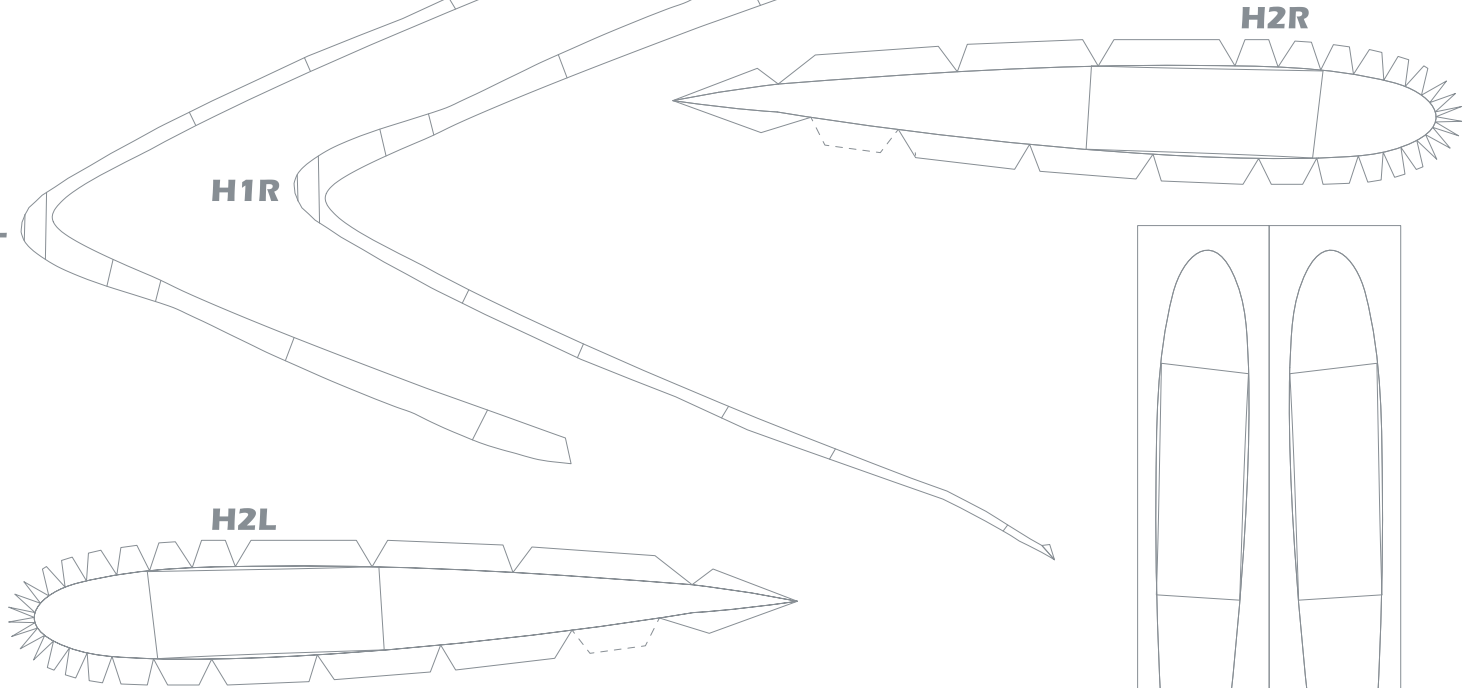
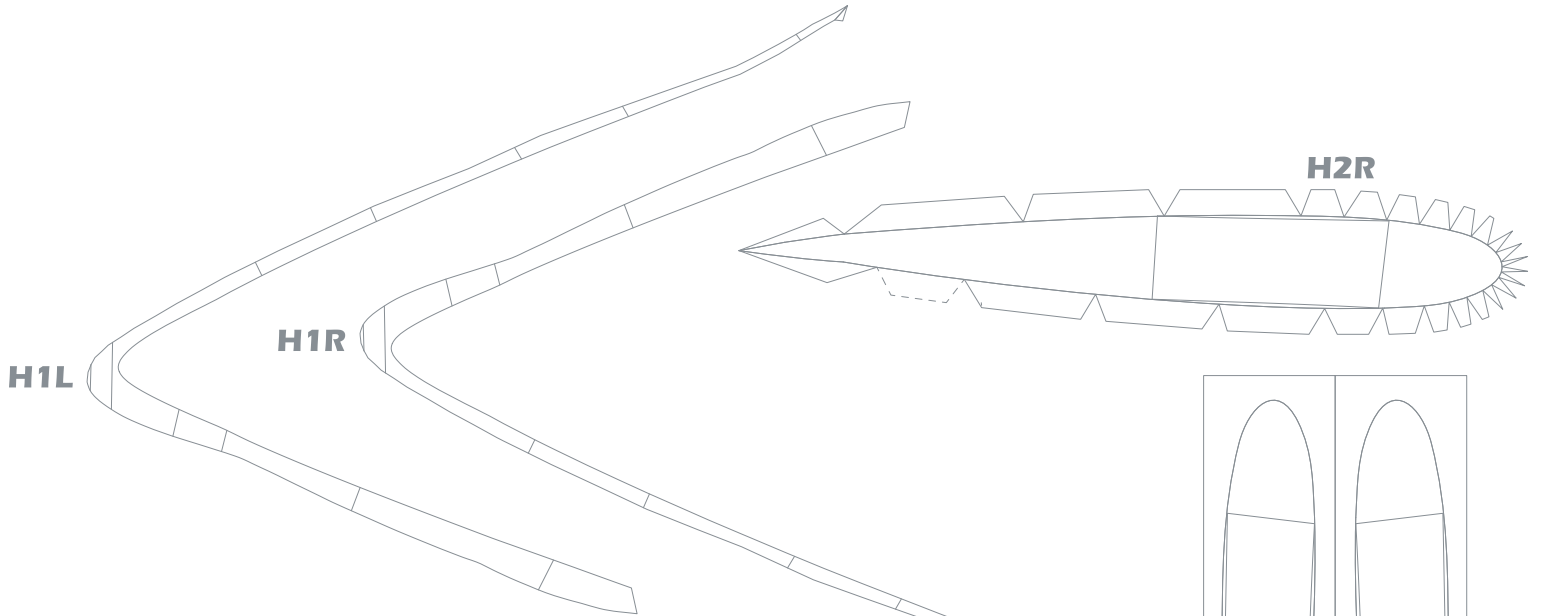

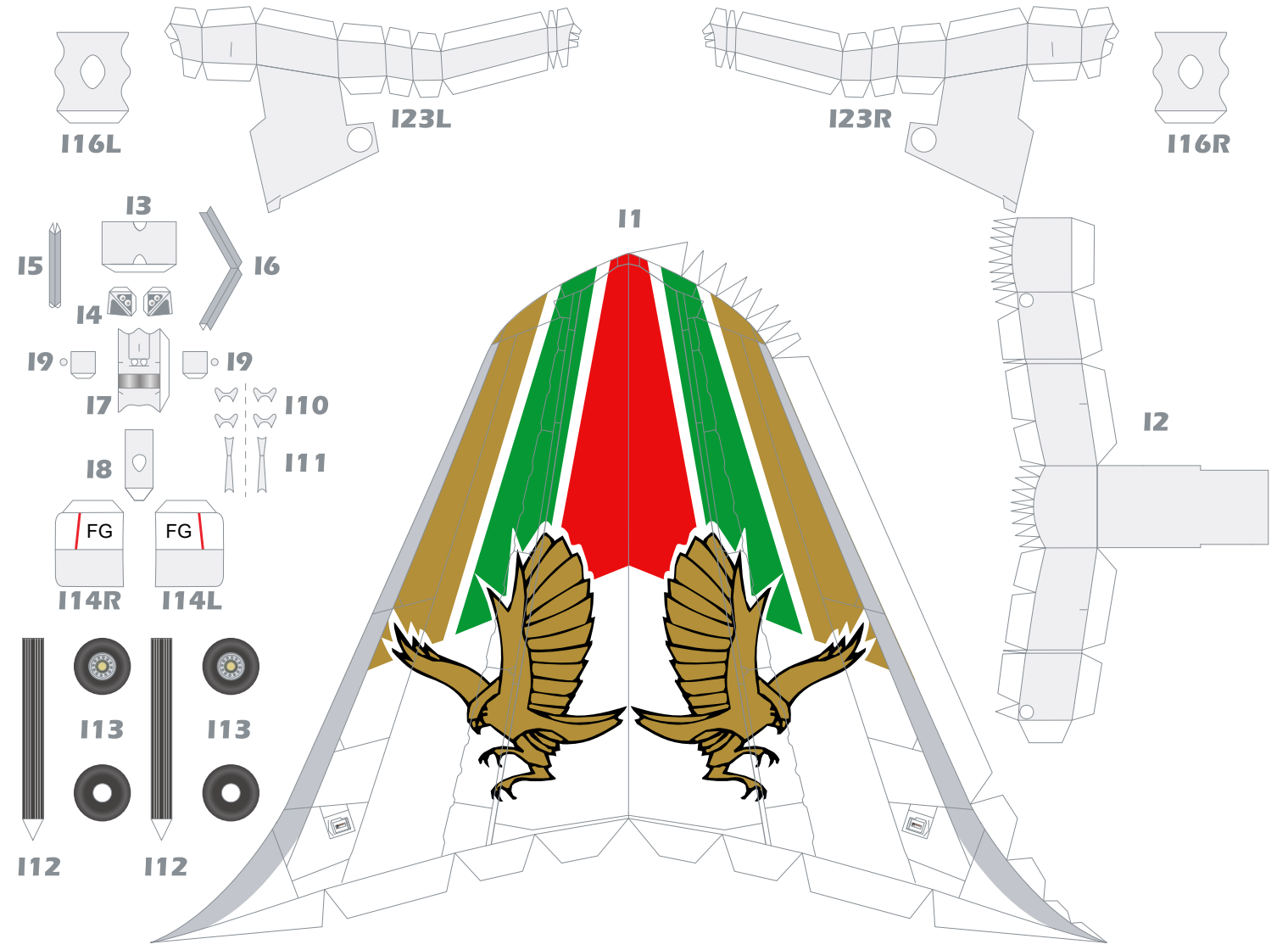
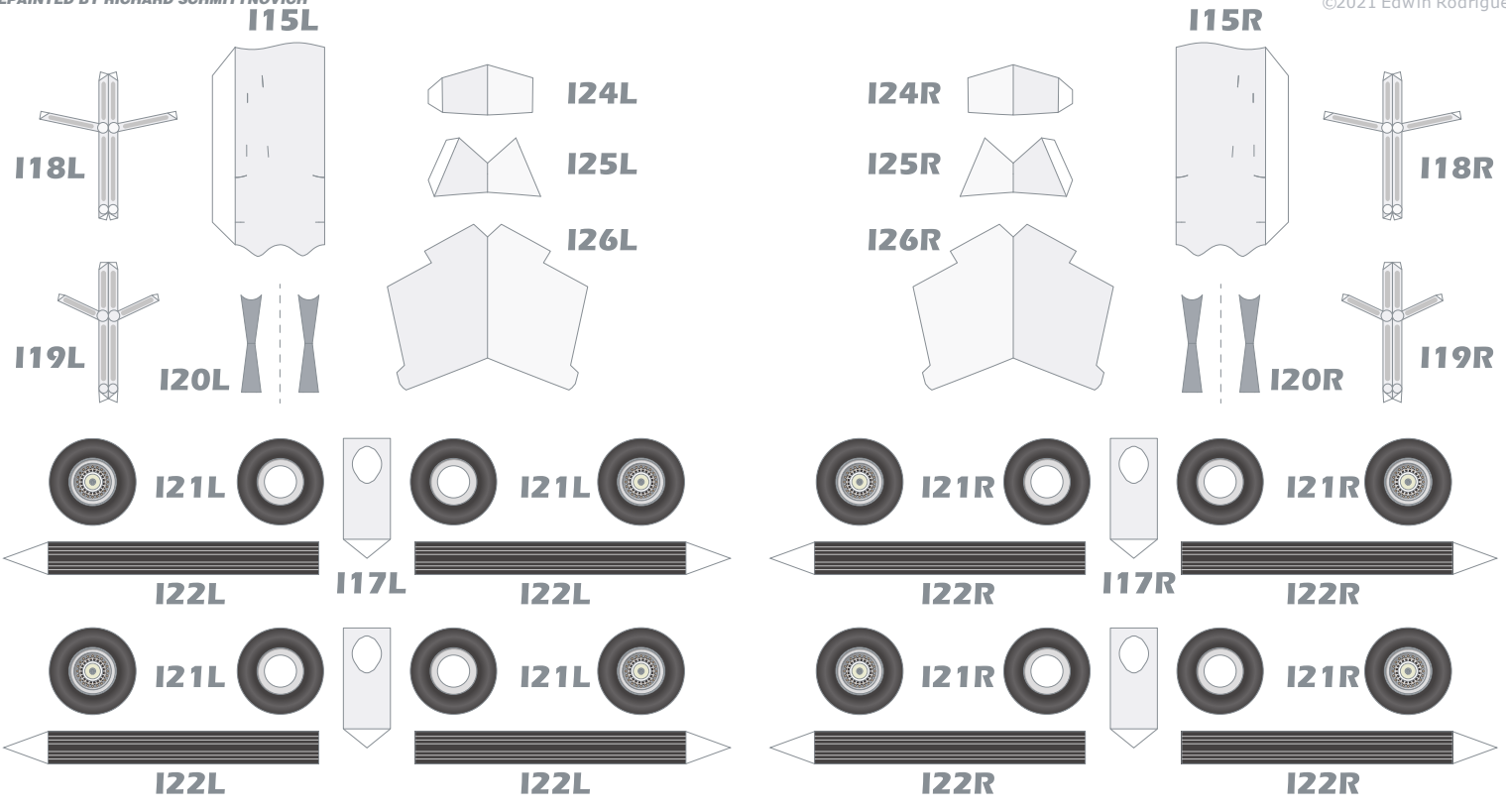

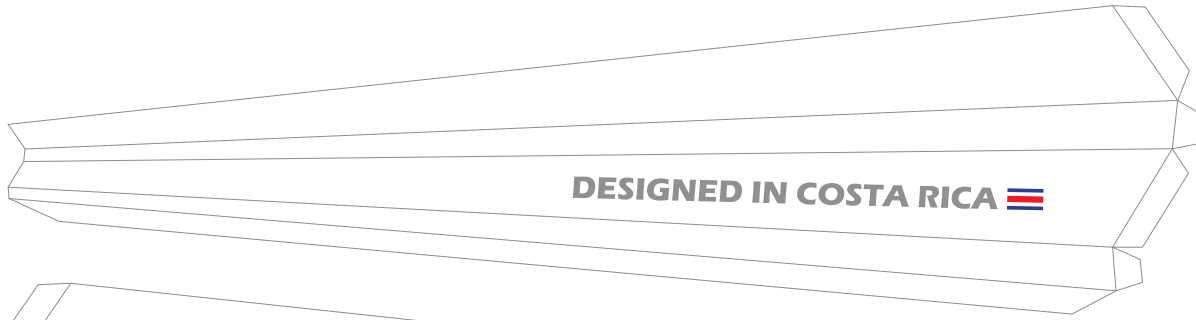

J1L

DESIGNED IN COSTA RICA 



J1R

FREE MODEL, DO NOT SELL THE FILE!!!

