

- B5\* 
- B7\* 
- B9\* 
- B6\* 
- B8\* 
- B10\* 

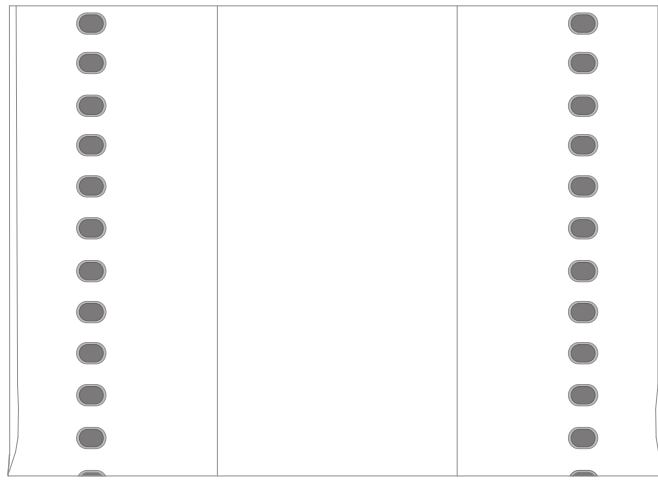

B3

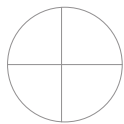
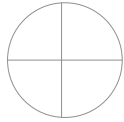
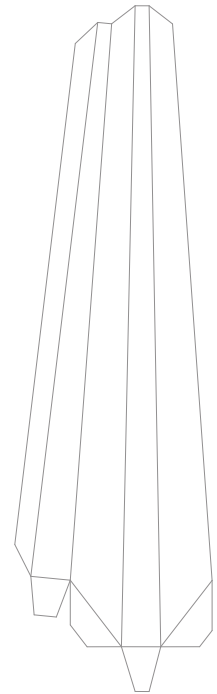

B13

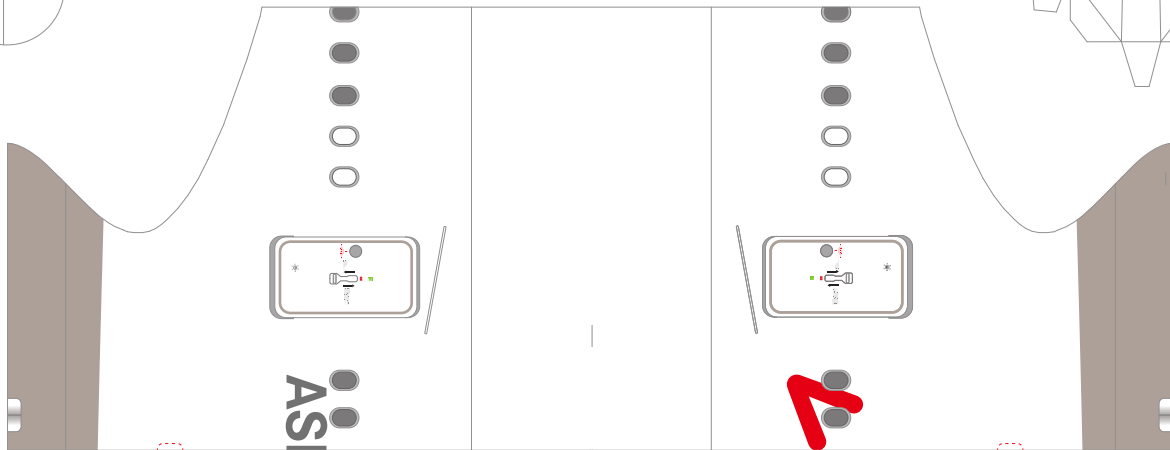

B2

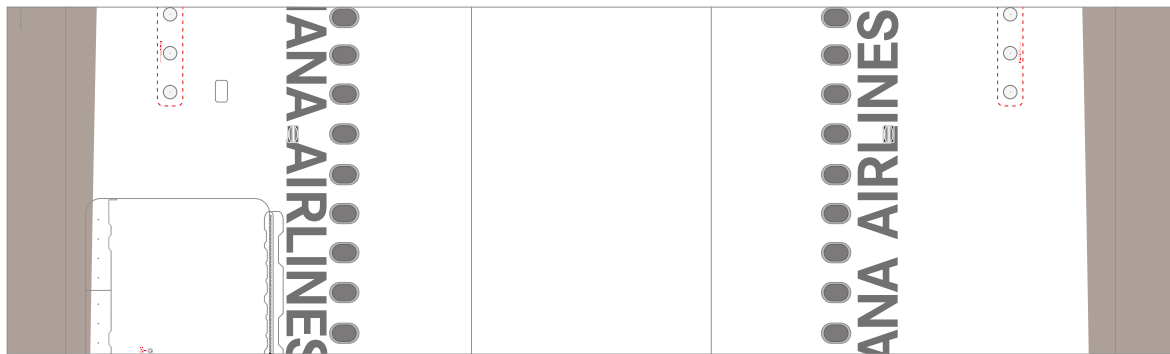

B1



B12R

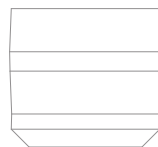

B11



B12L

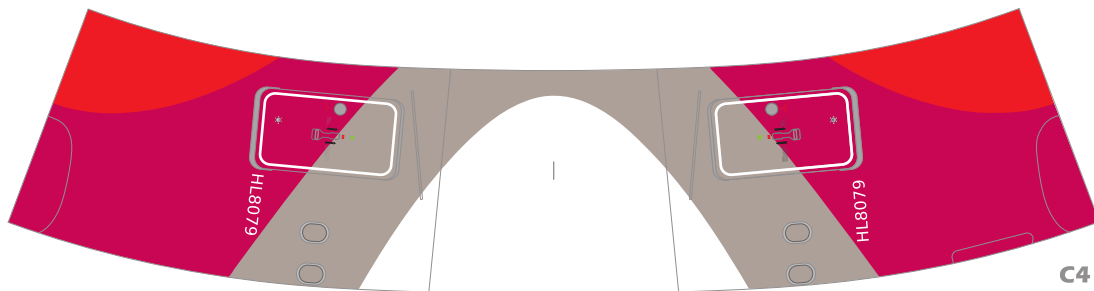

C4

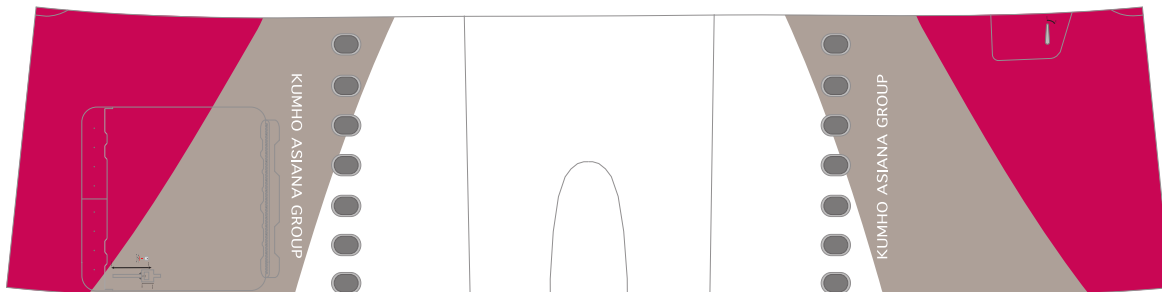

C3

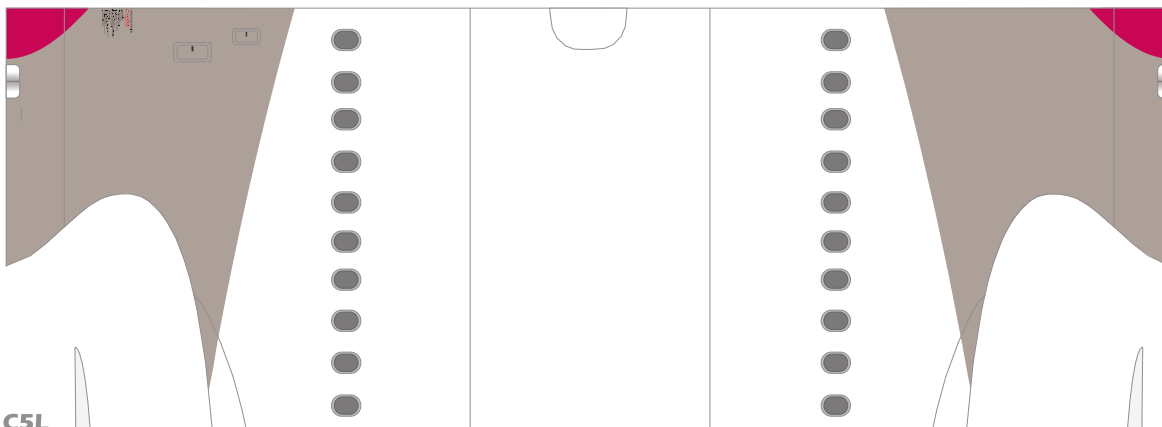

C2

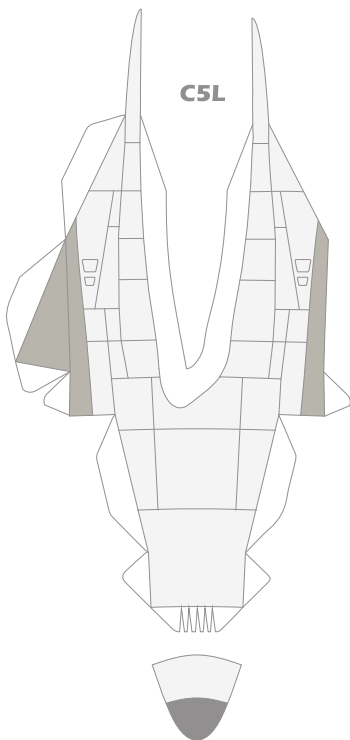

C5L

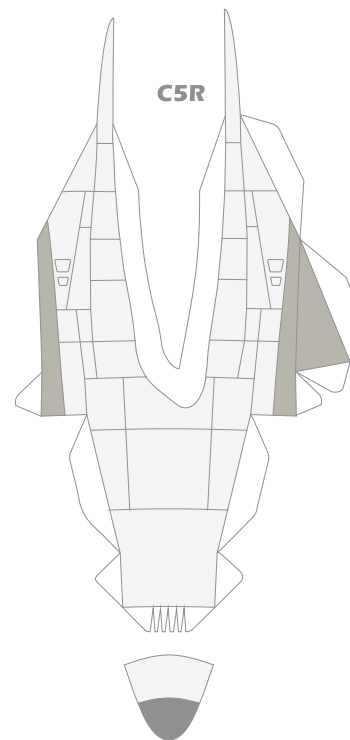

C5R

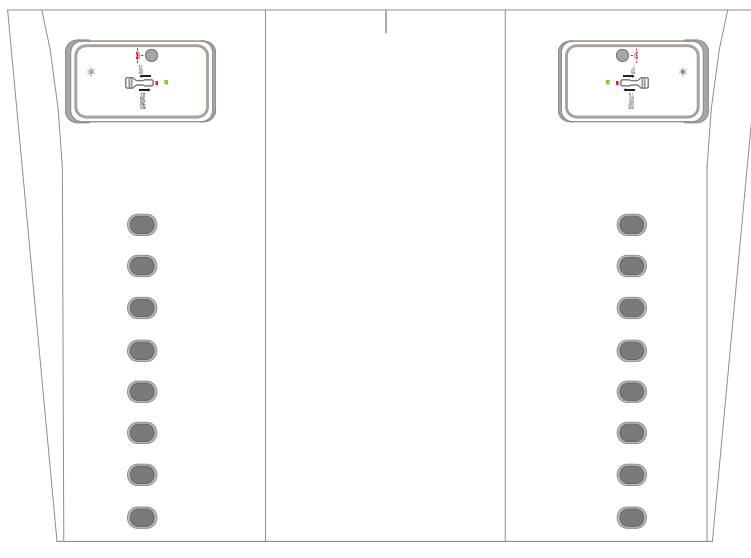

C1

C6L

C6R

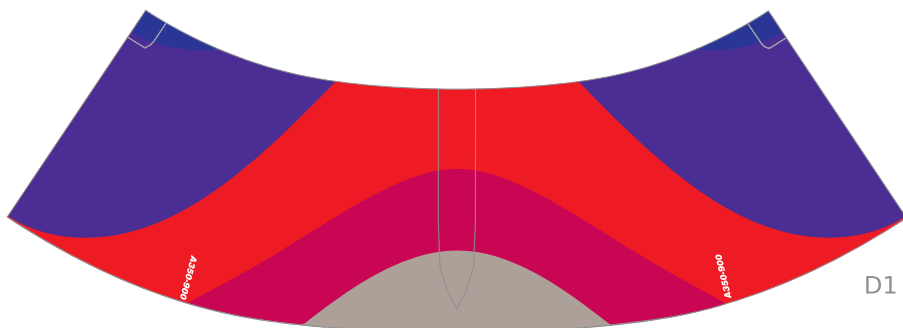
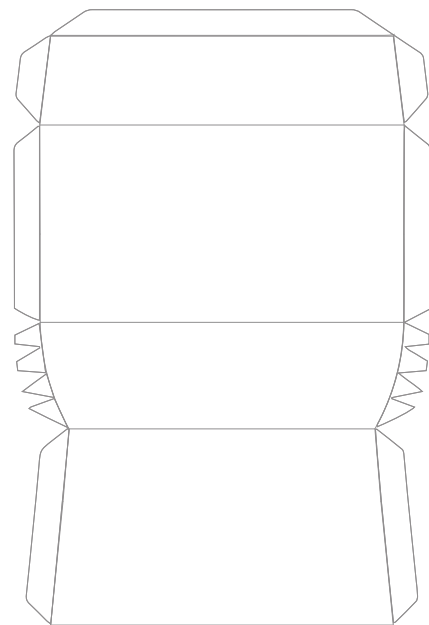
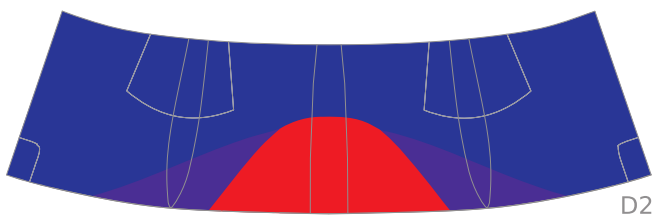
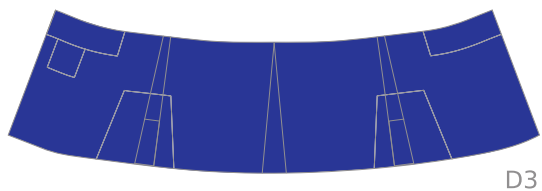
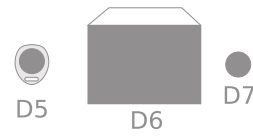
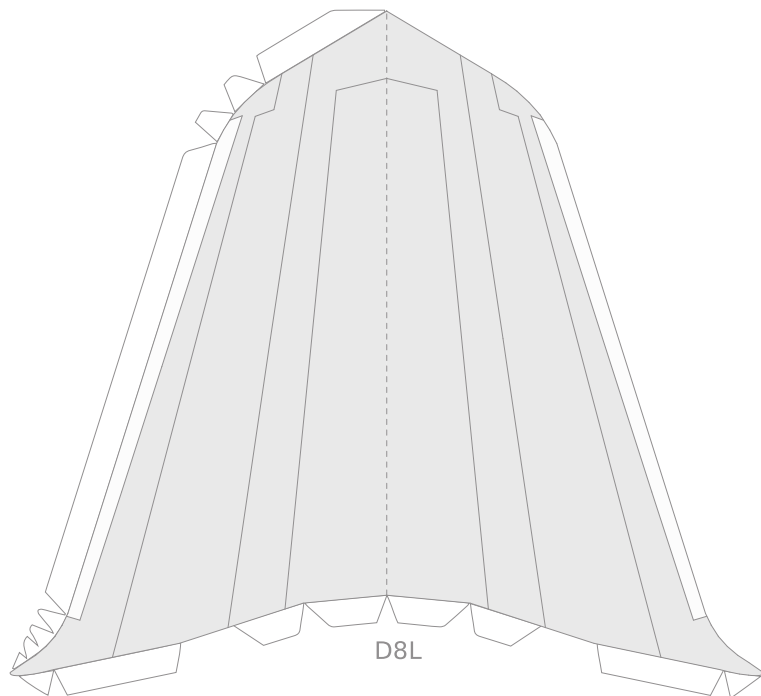
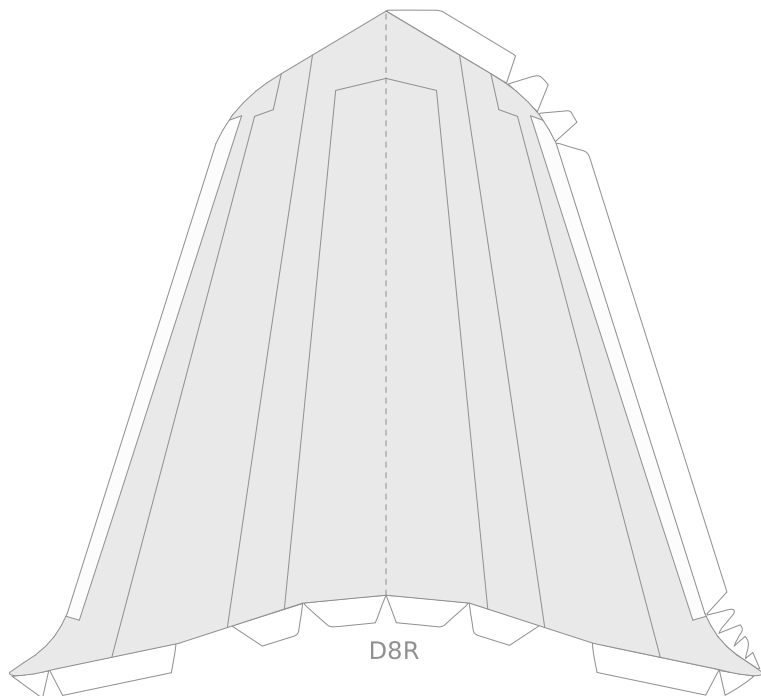

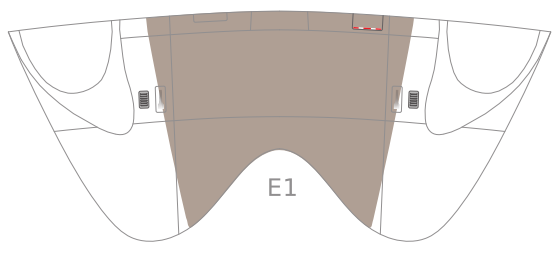
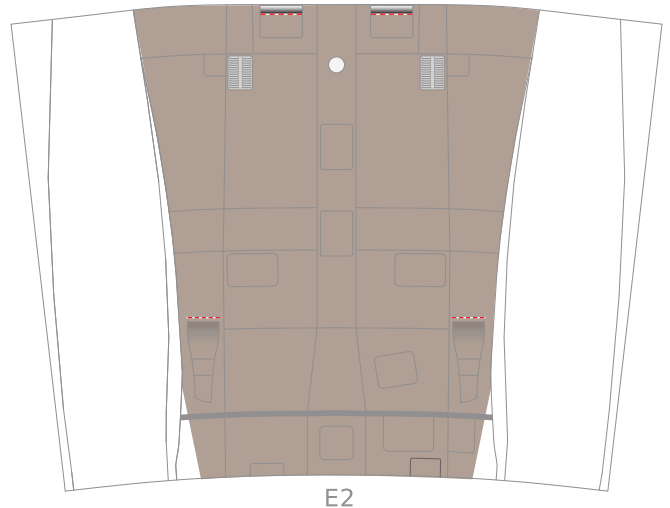
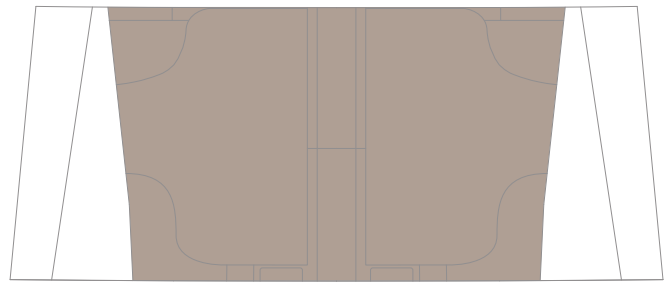
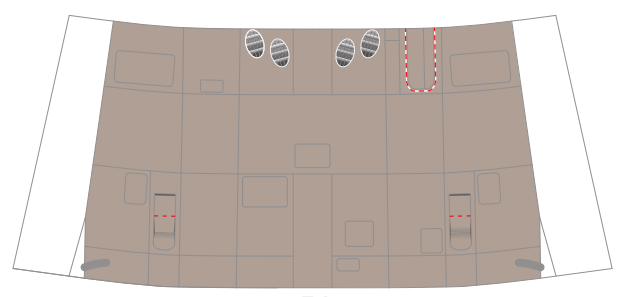
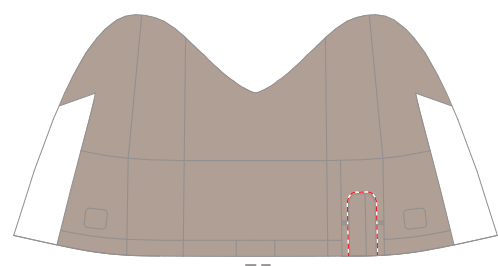
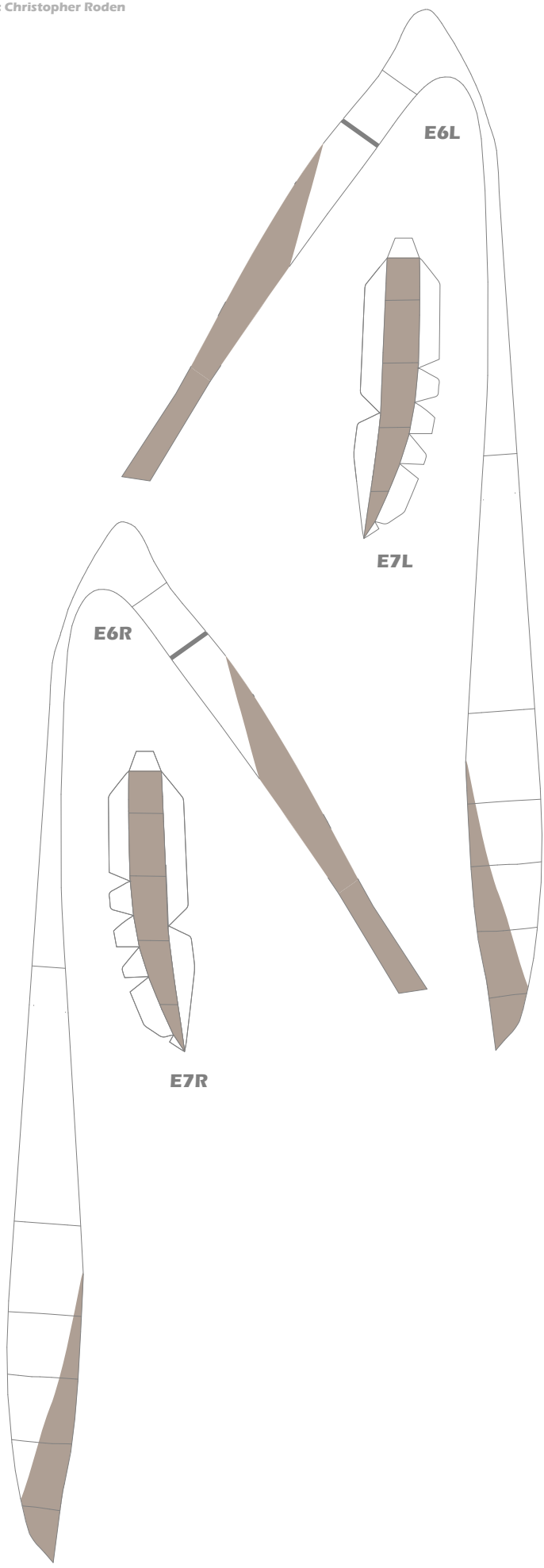

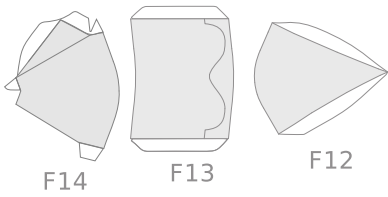
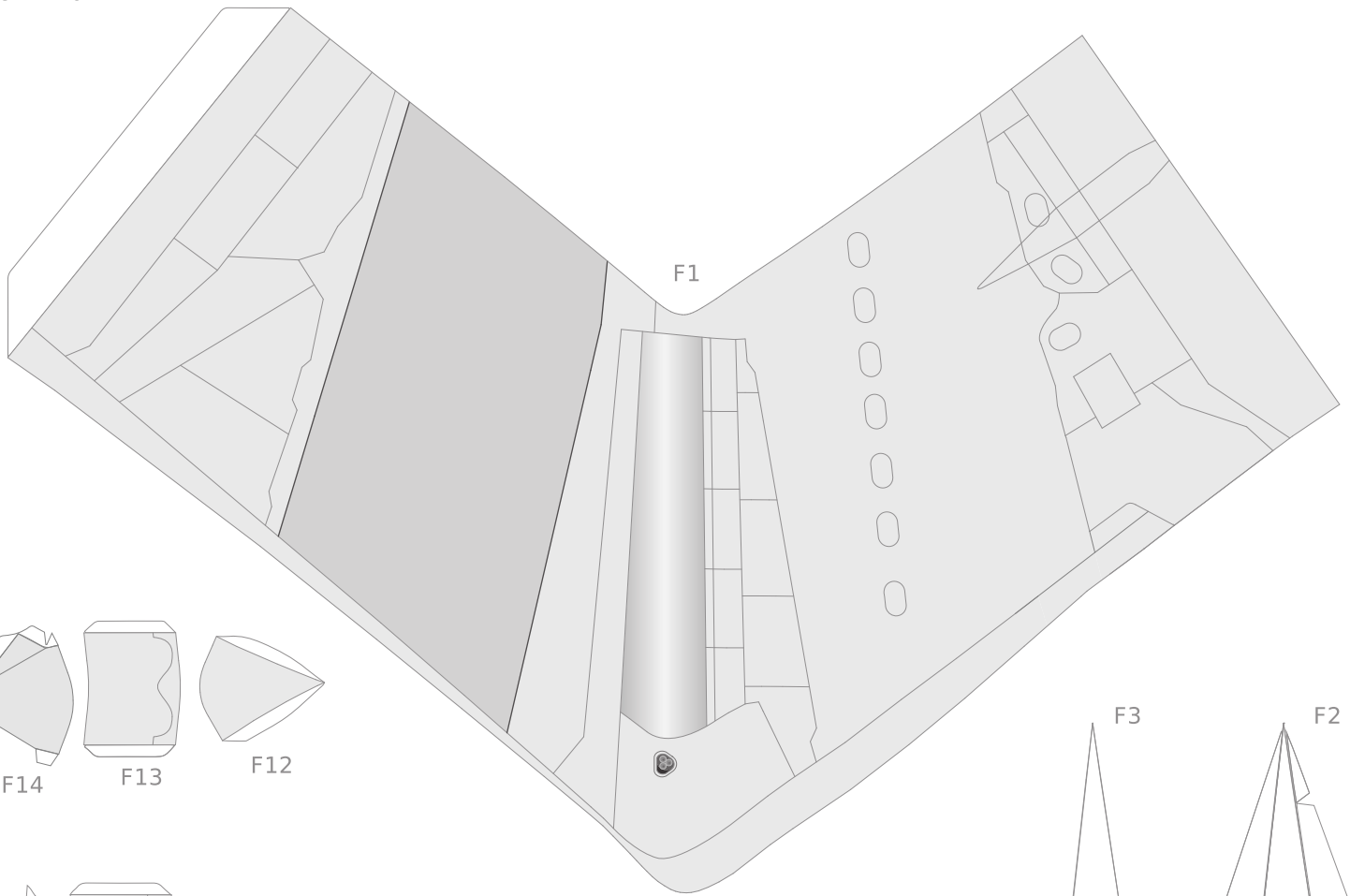

F14

F13

F12

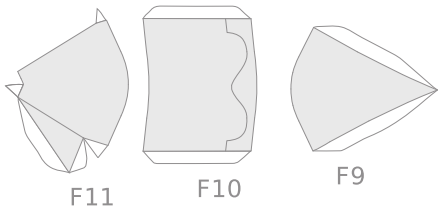

F11

F10

F9

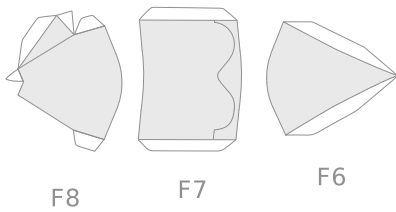

F8

F7

F6

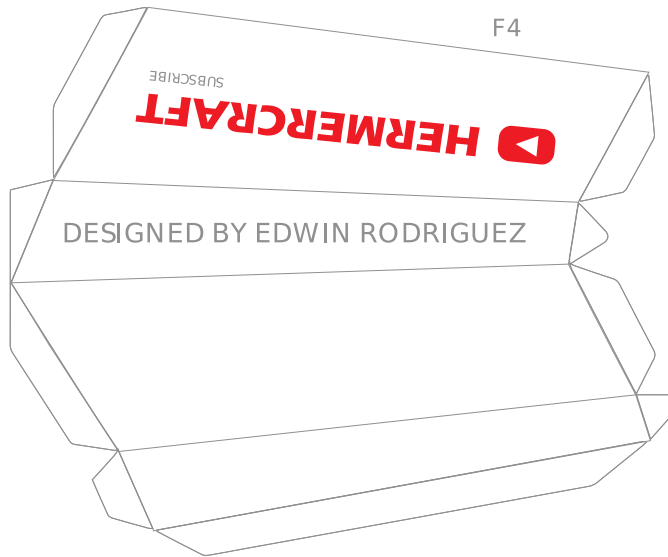

F4

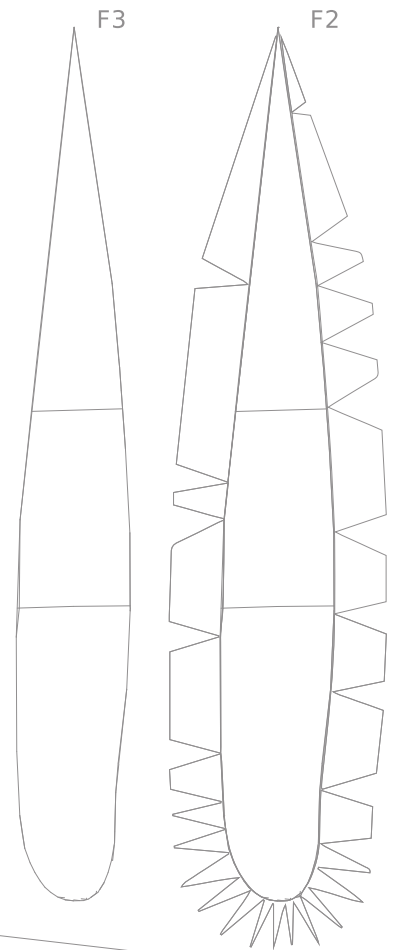

F3

F2



F5

**FREE MODEL, DO NOT SELL THE FILE!!!**

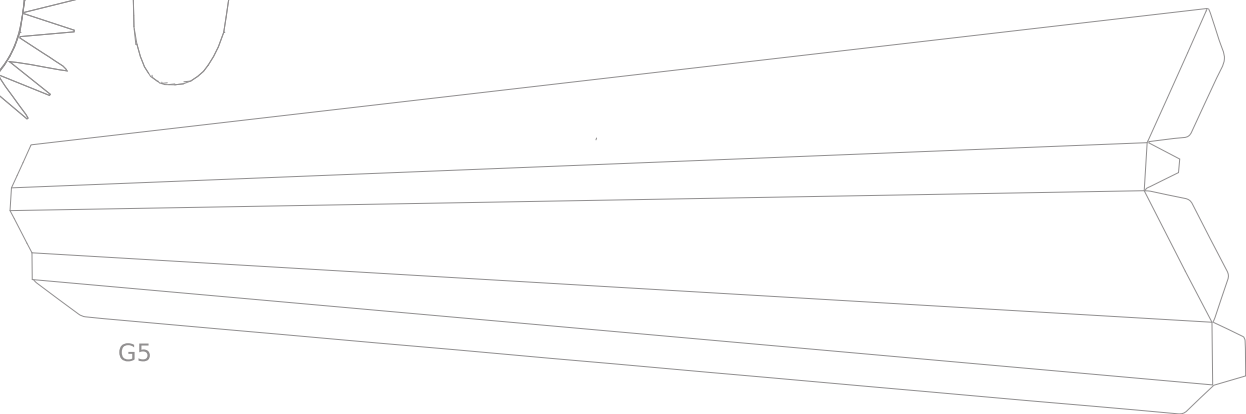
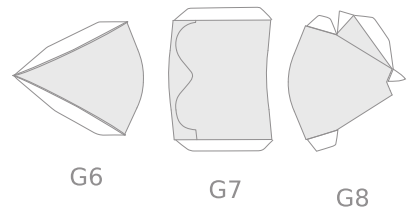
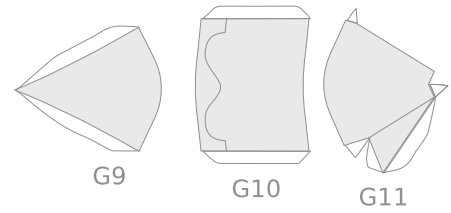
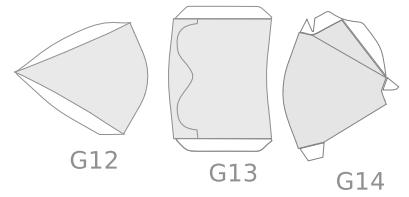
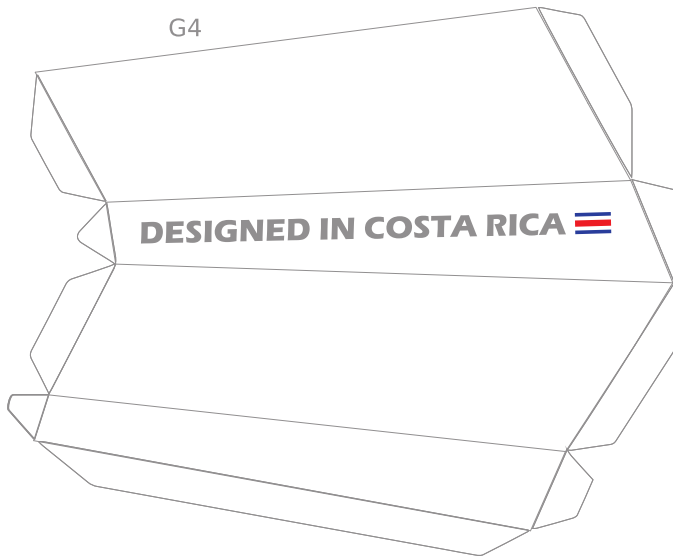
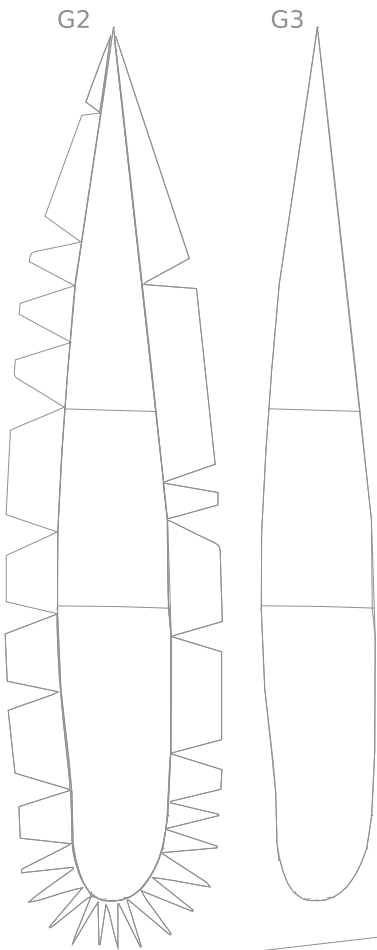
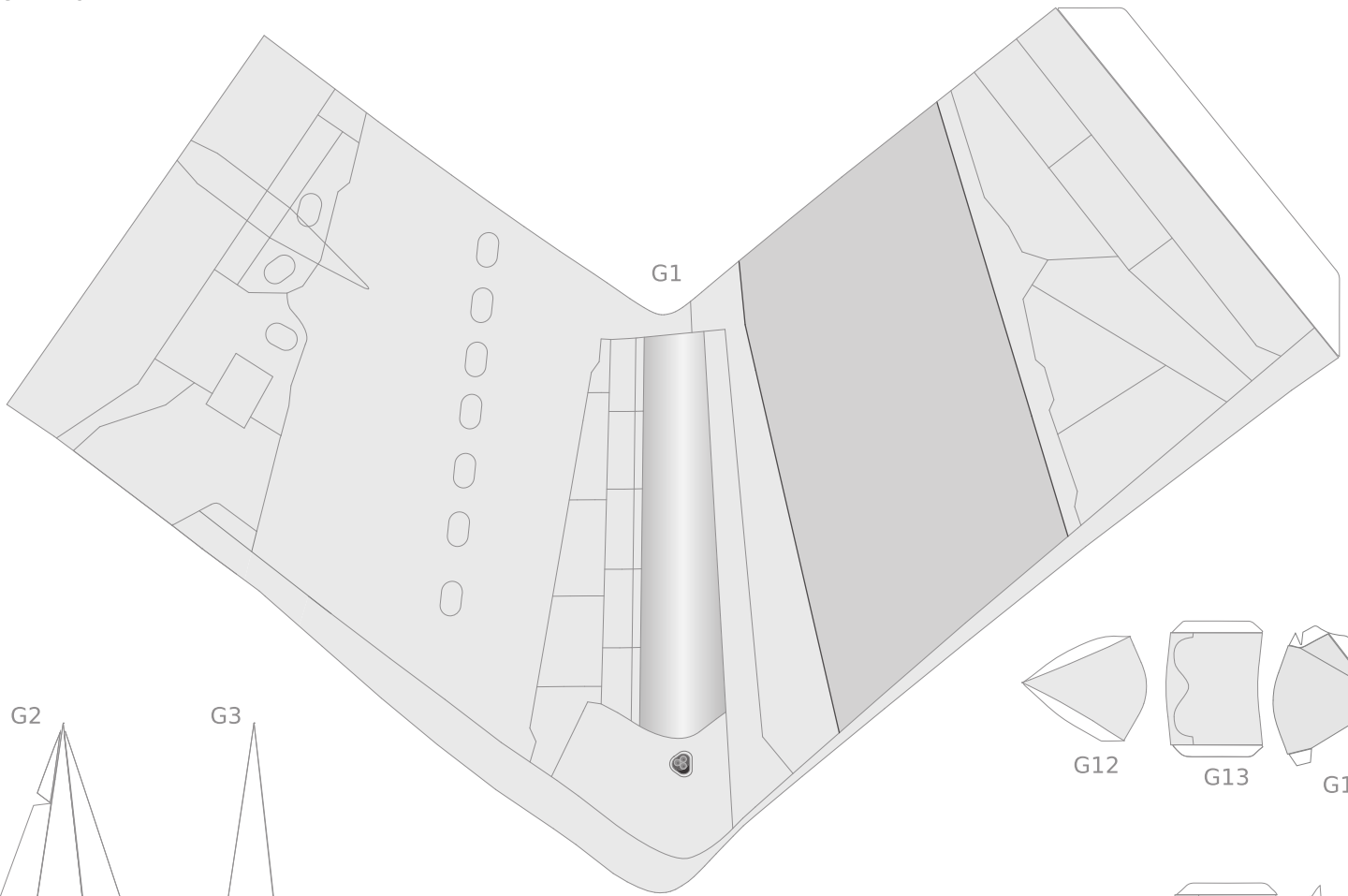

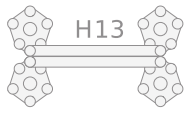
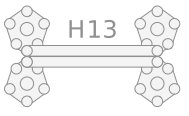
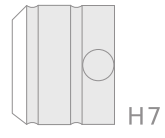
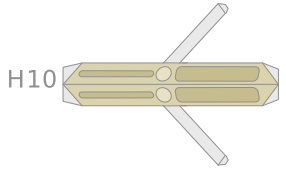
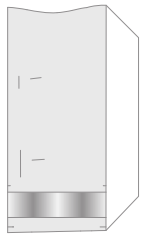
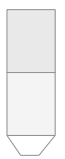
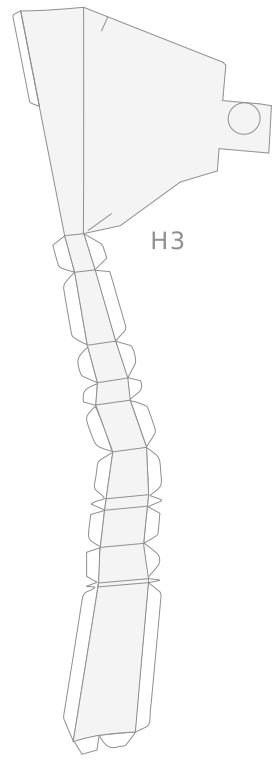
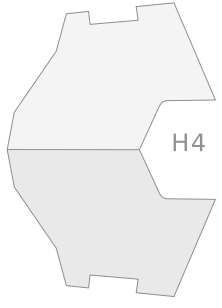
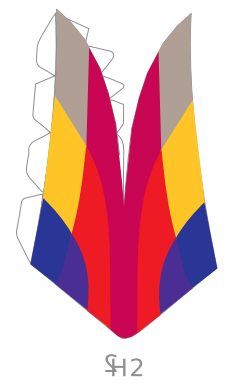
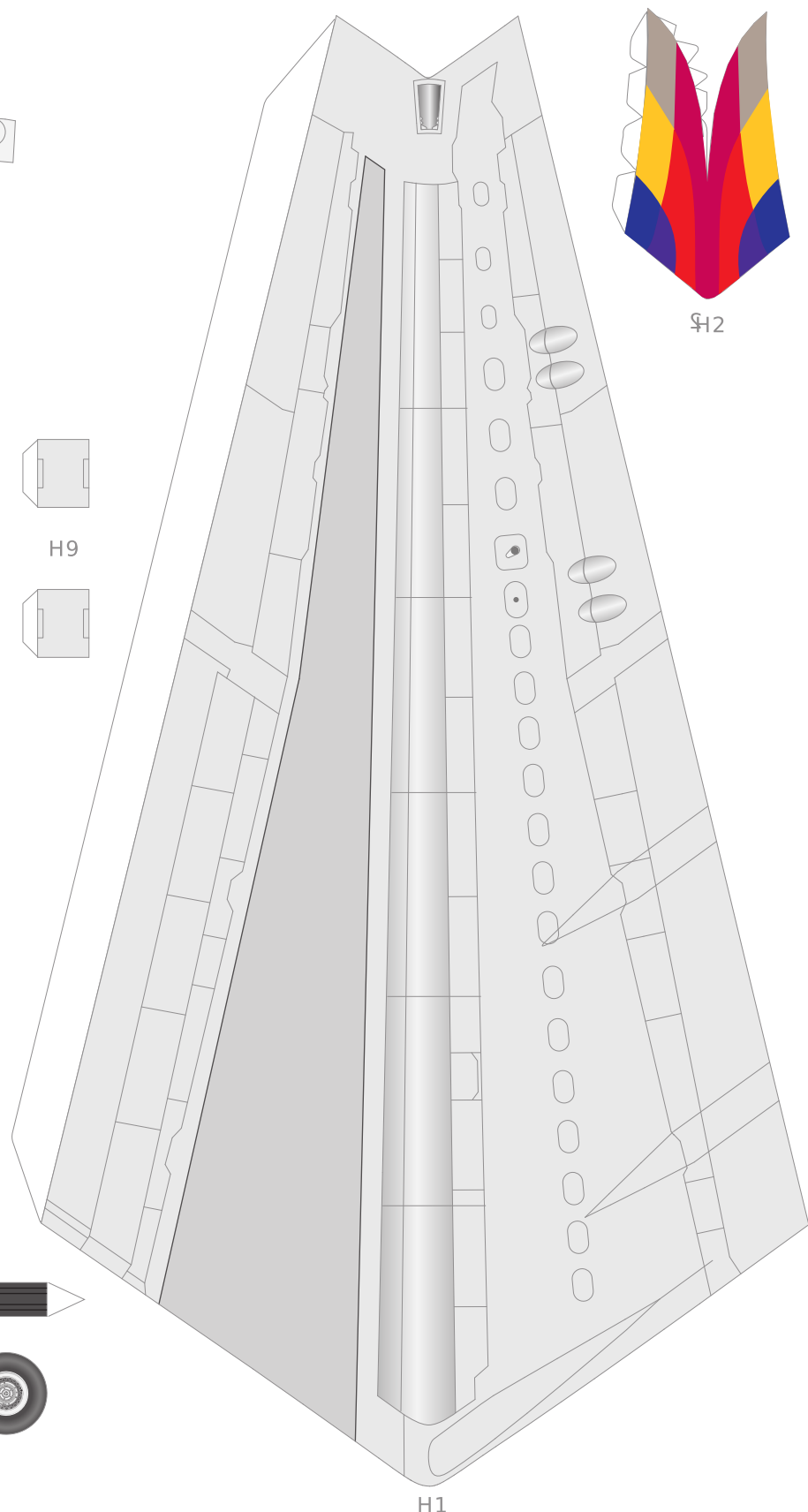

H1

H4

H3

H5

H9

H6

H8

H10

H7

H11

H12

H13

H13

H14

H15

H14

H15

H12



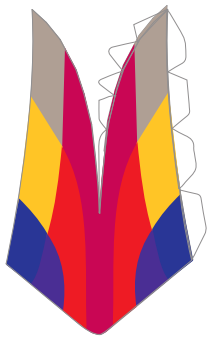

12

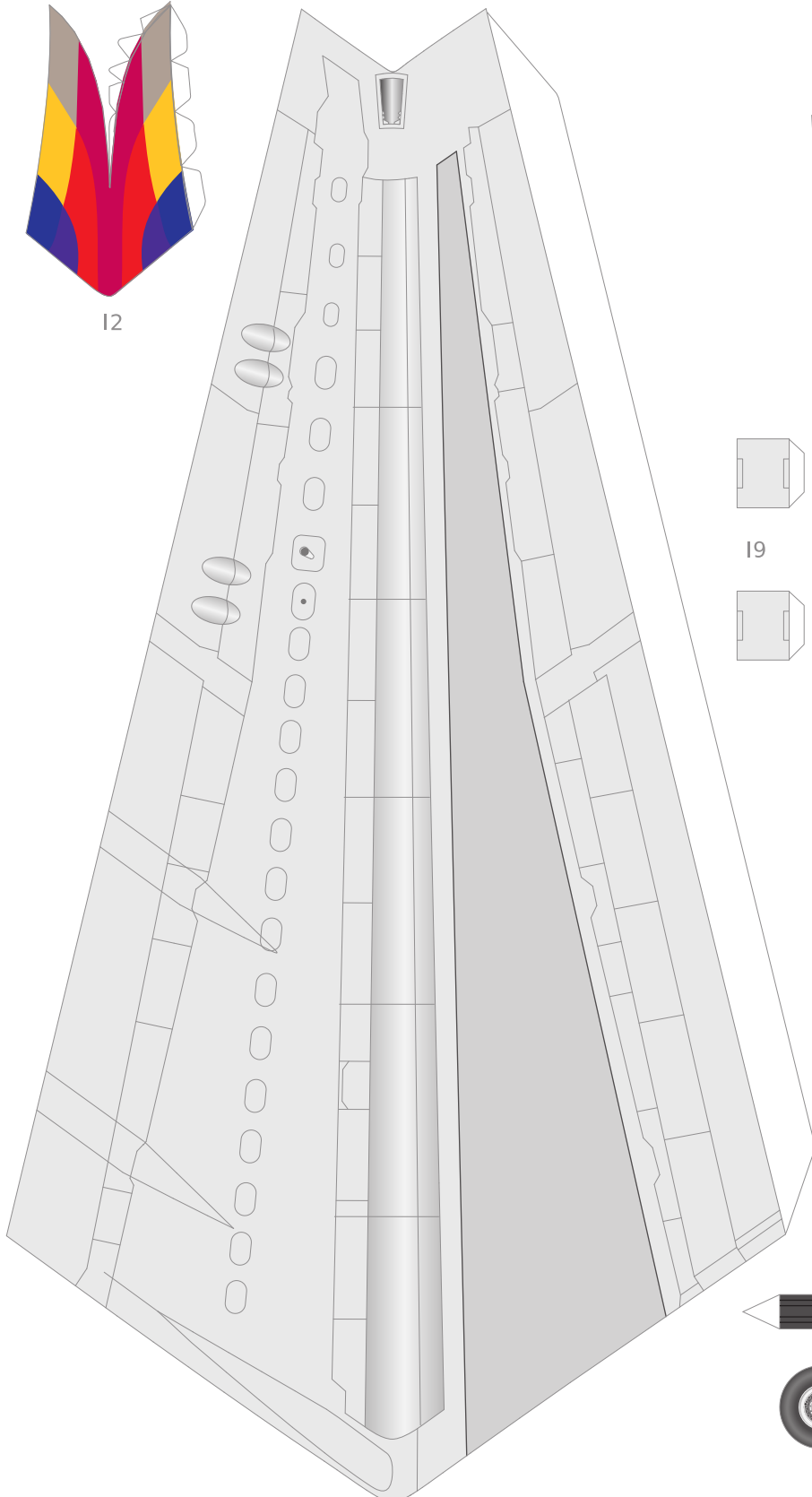

11

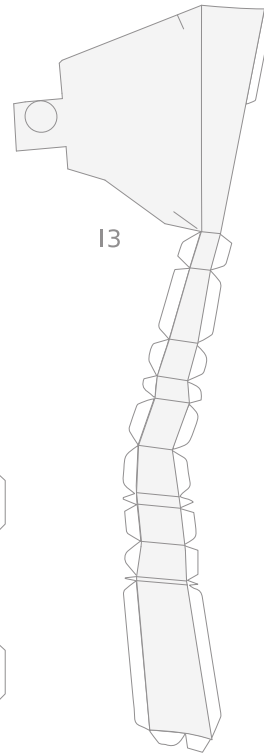

13

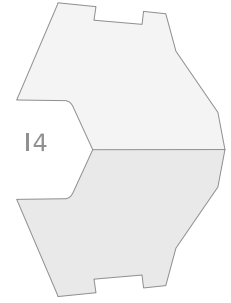

14



19

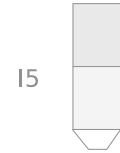

15



18



16

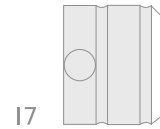

17

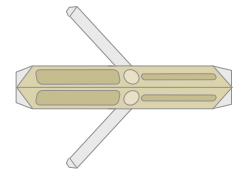

110



112



111

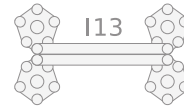

113

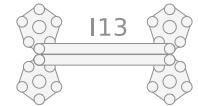

113



114



115



114



115

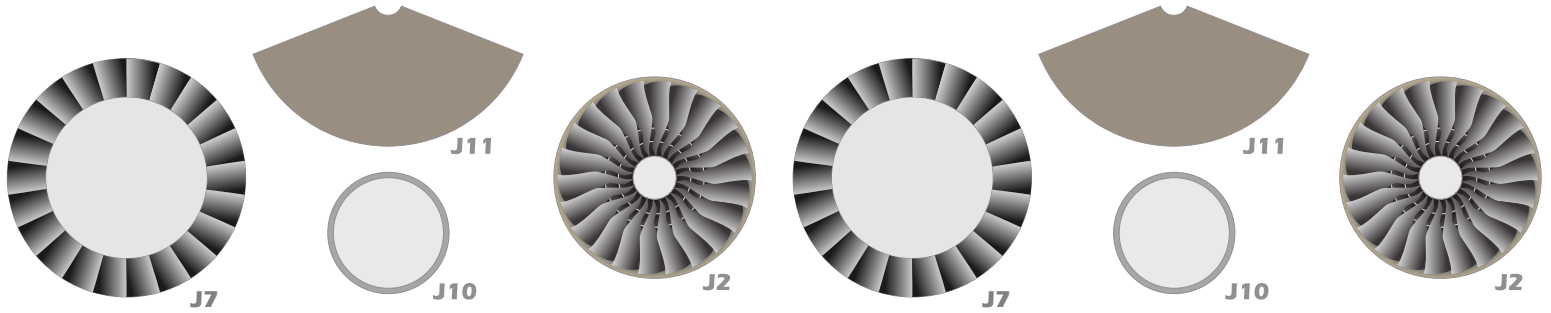
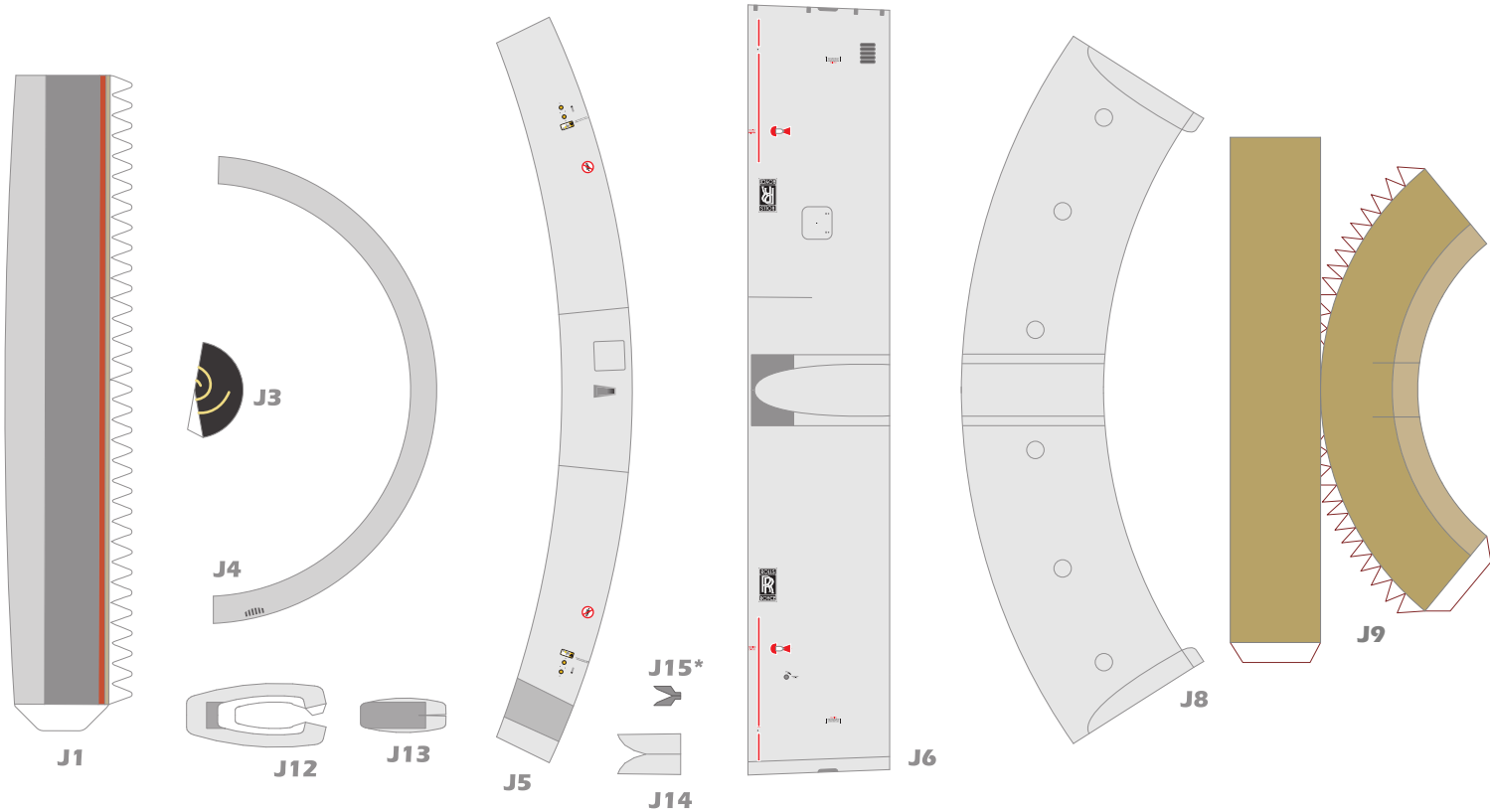
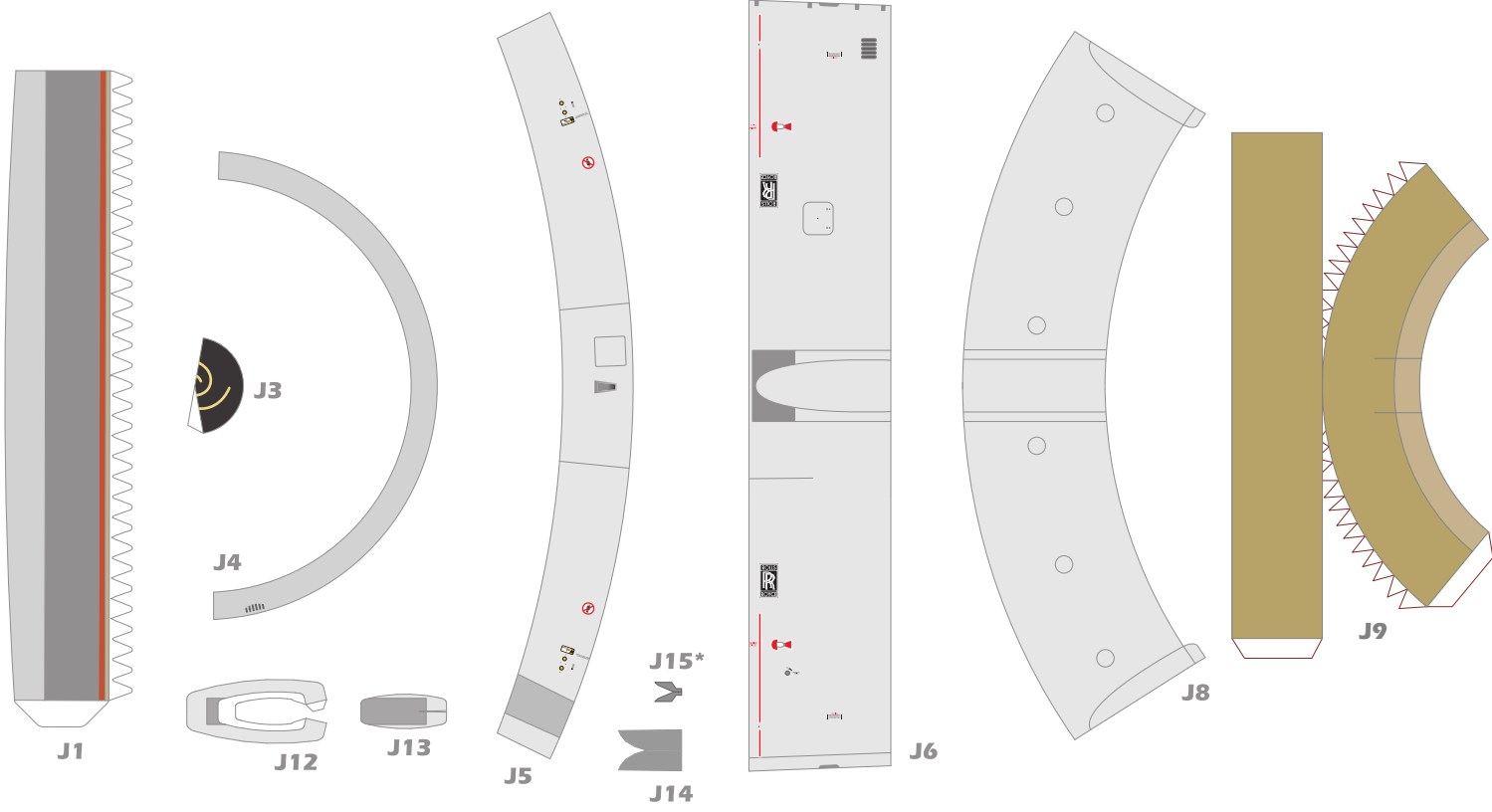

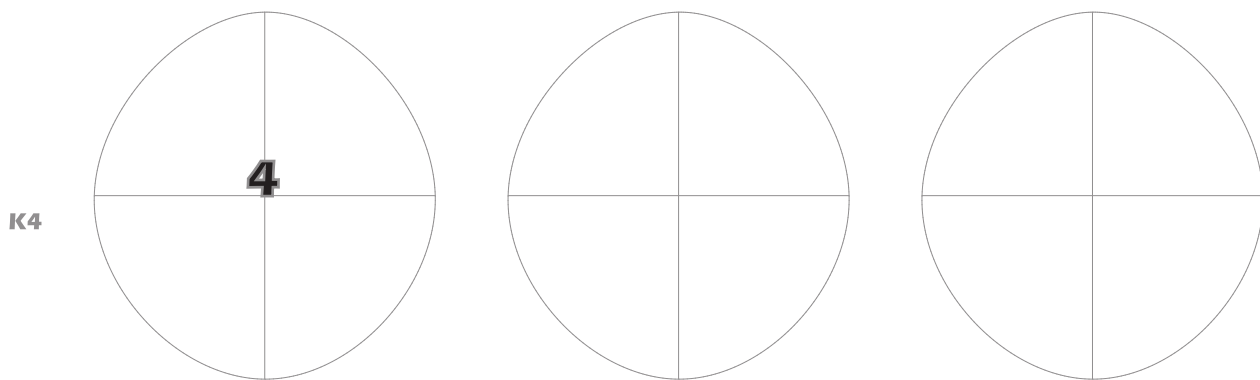
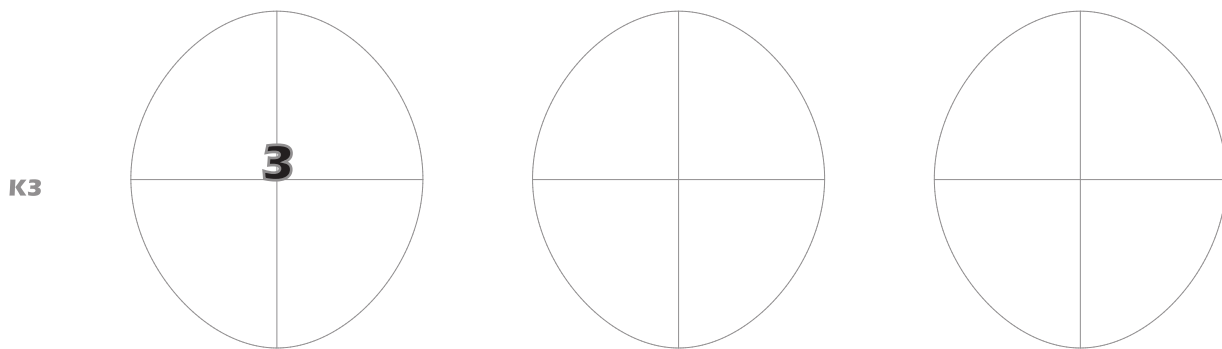
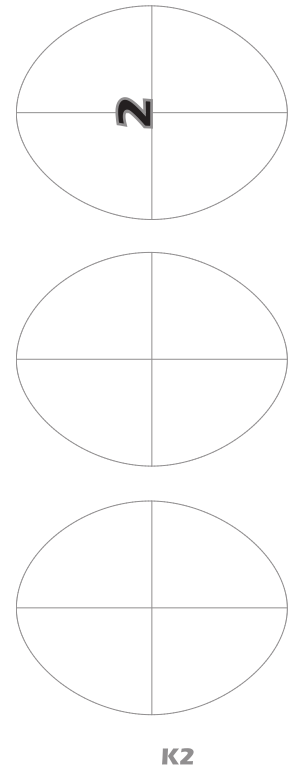
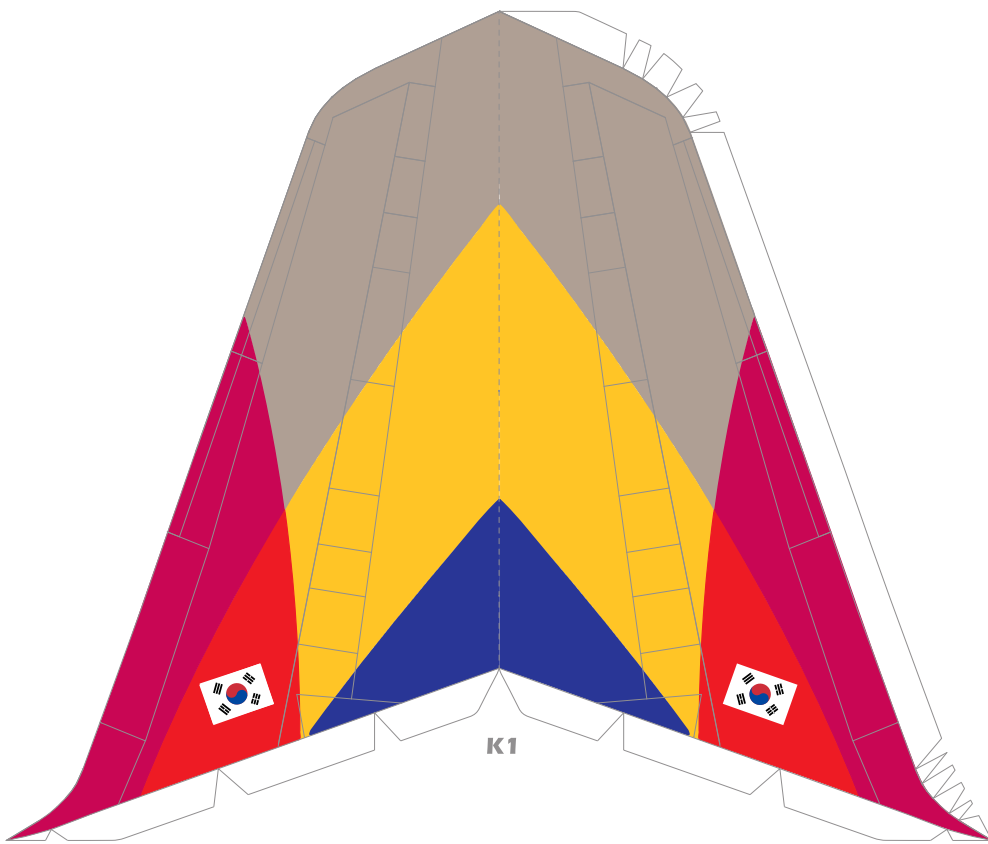

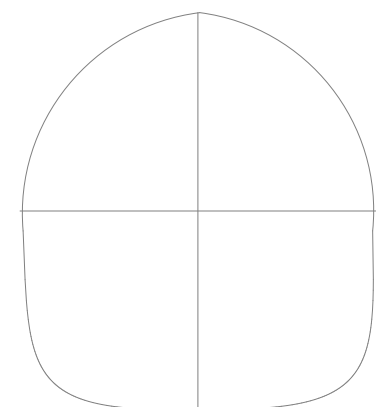
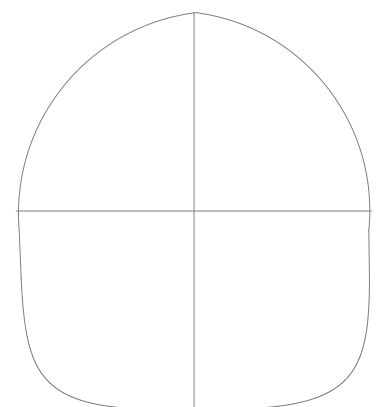
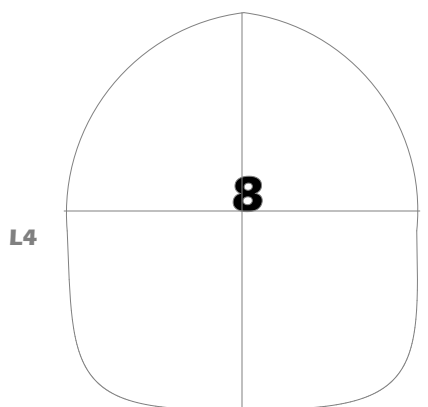
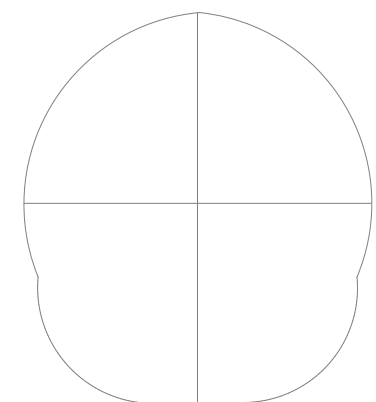
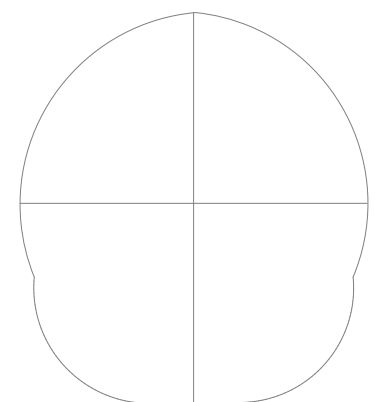
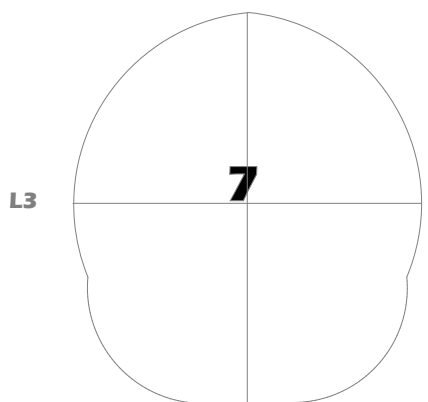
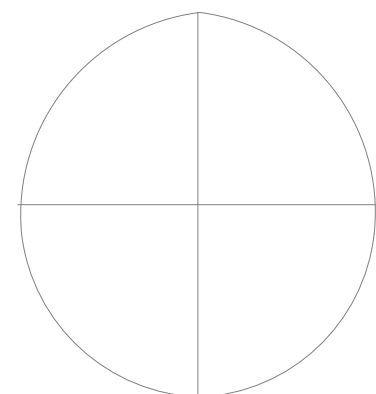
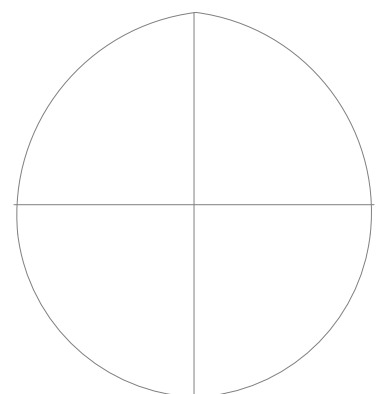
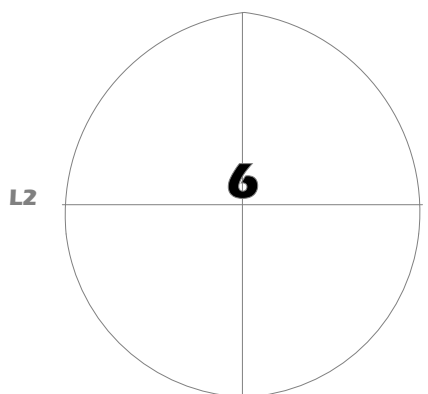
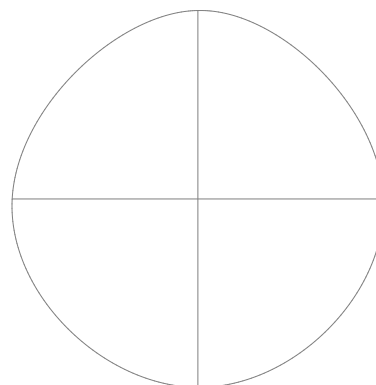
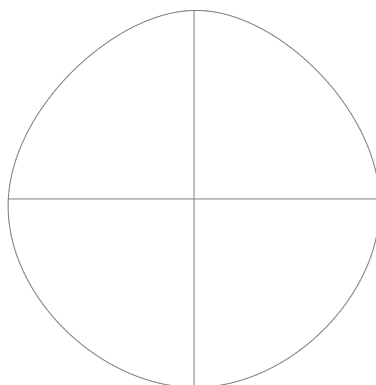
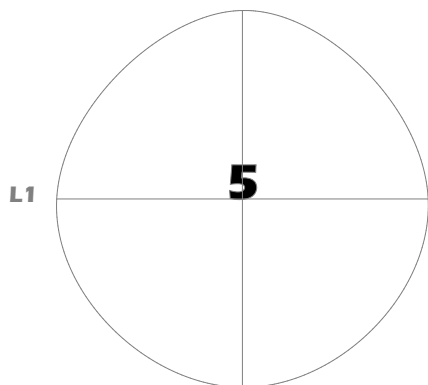

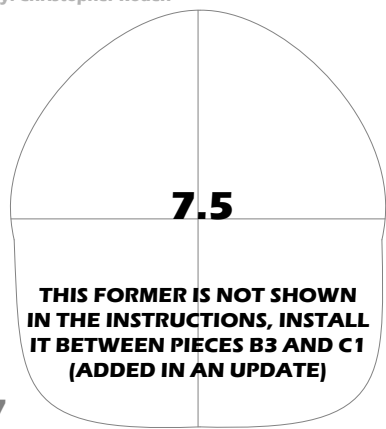

M7

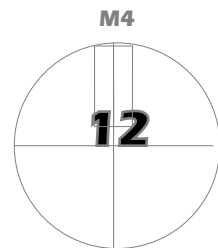
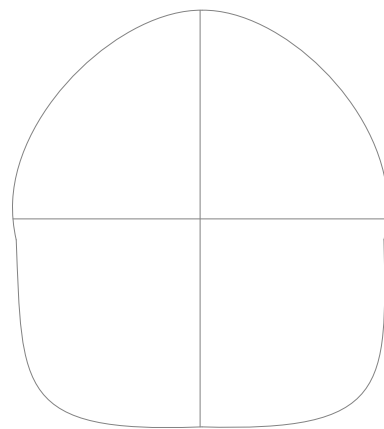
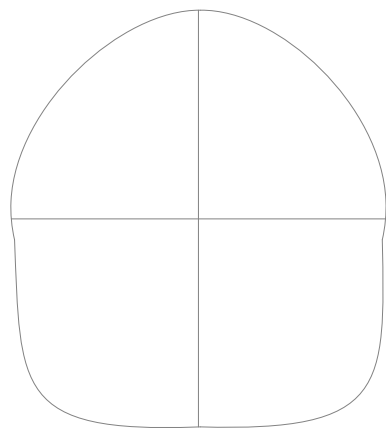

M4

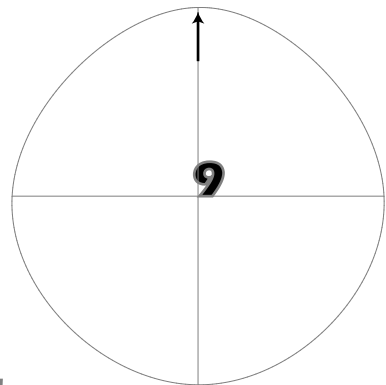
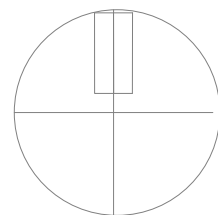
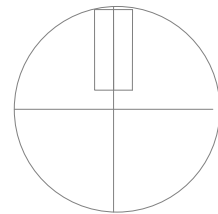

M1

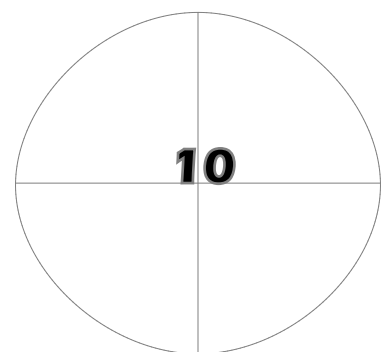
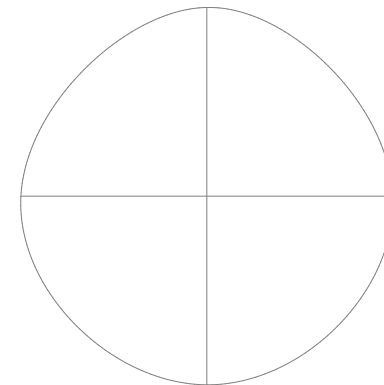
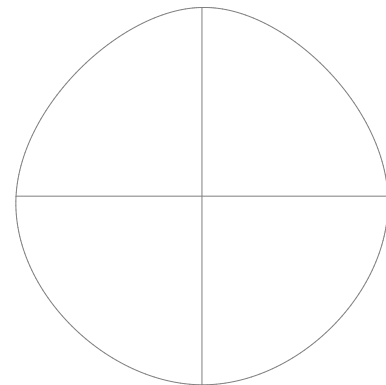

M2

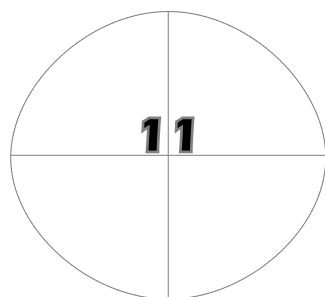
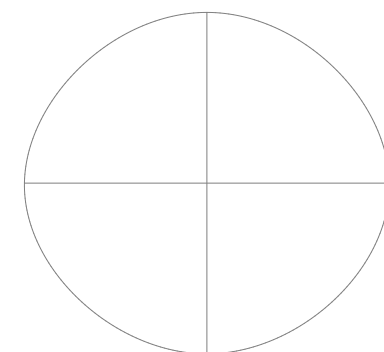
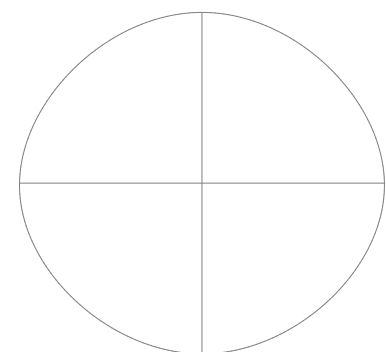

M3

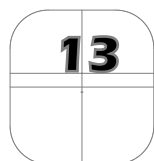
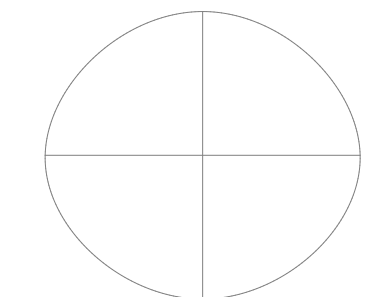
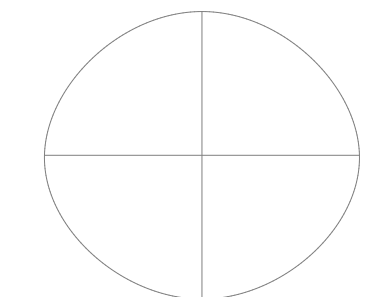

M5

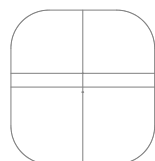
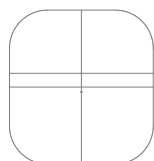

M6

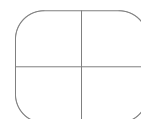
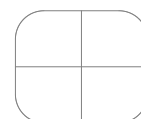

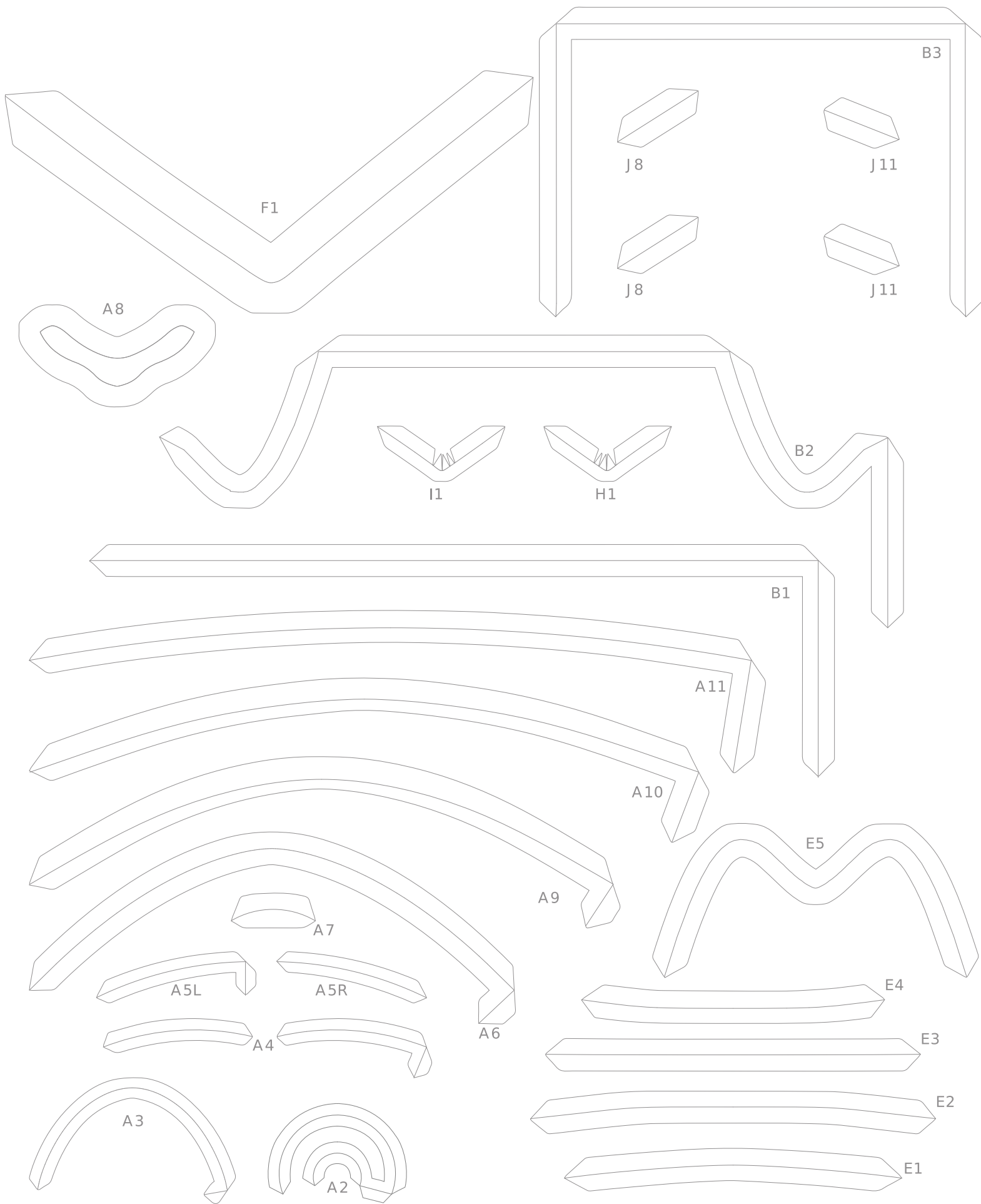

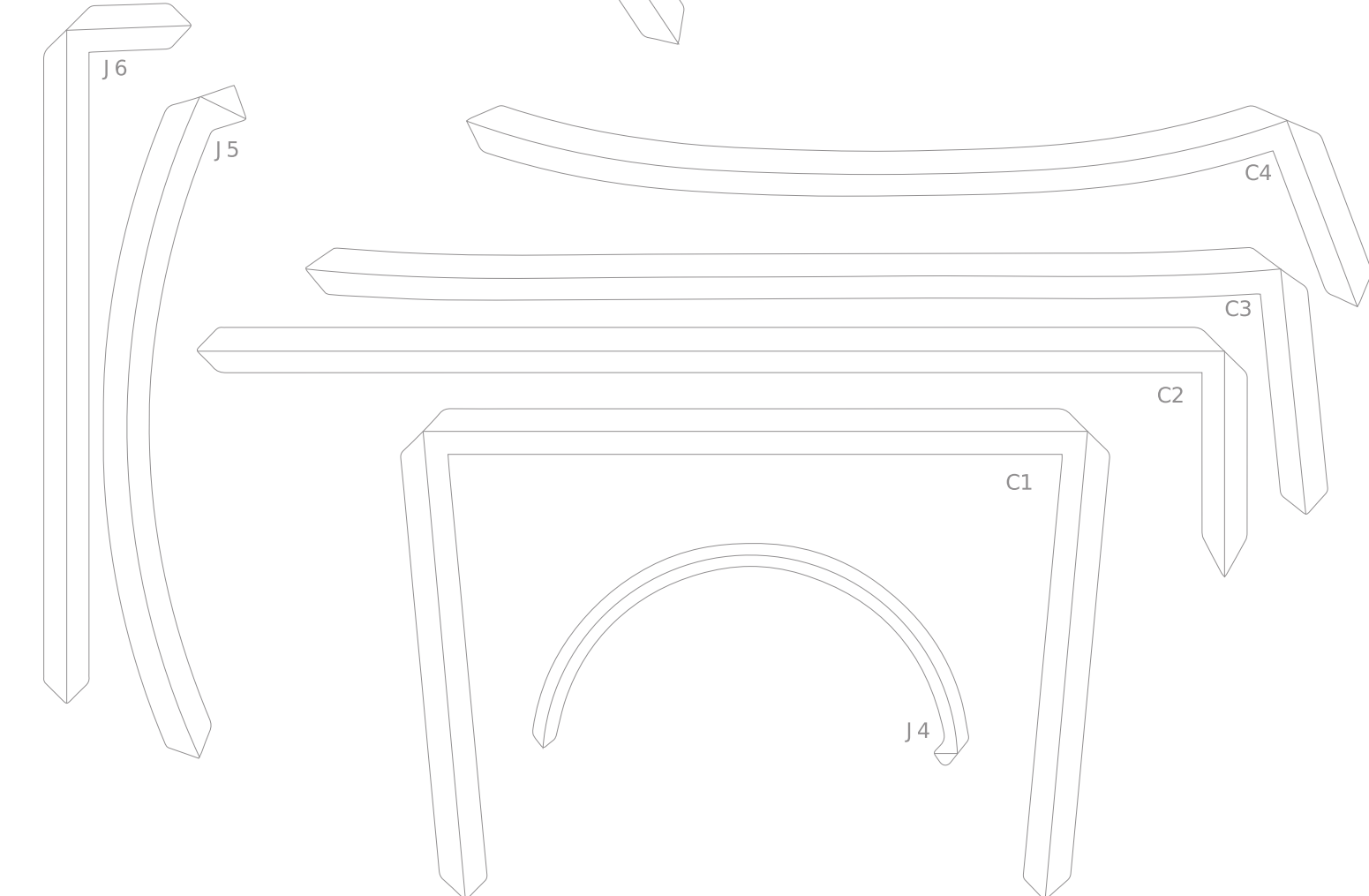
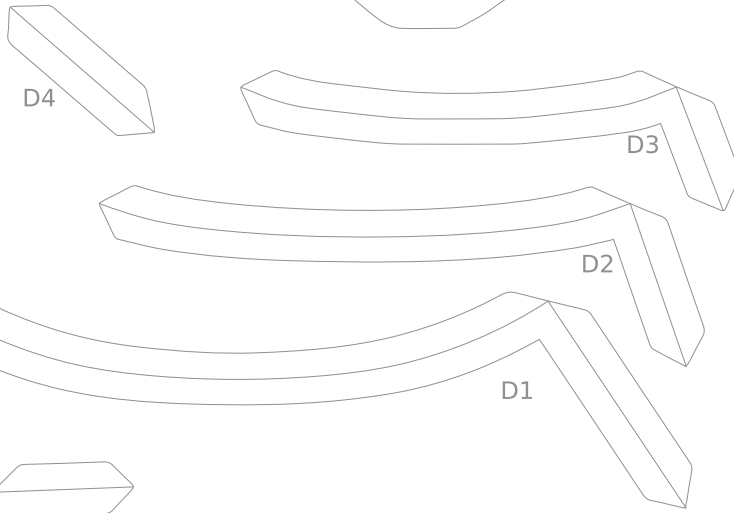
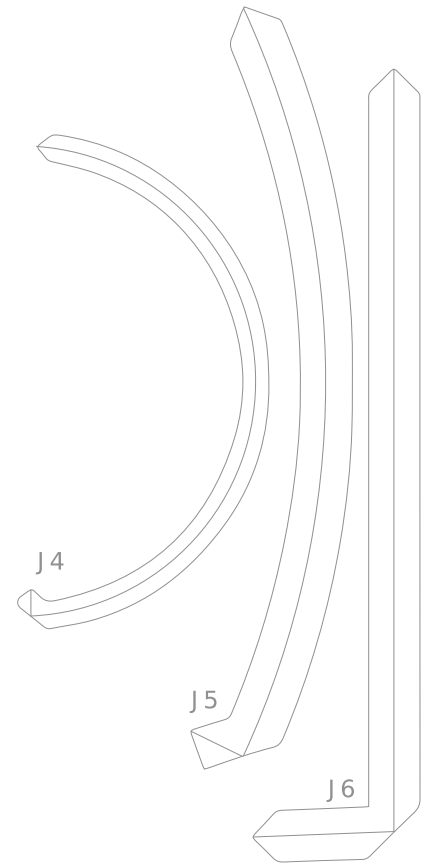
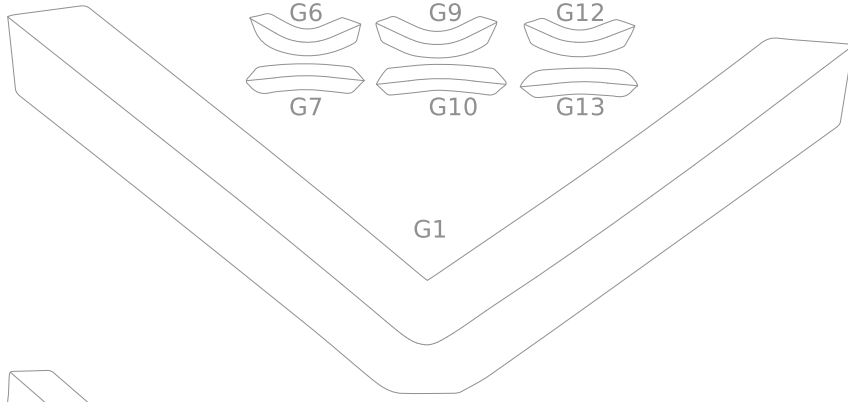
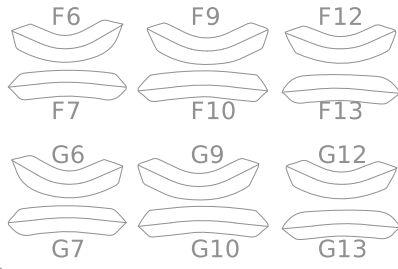

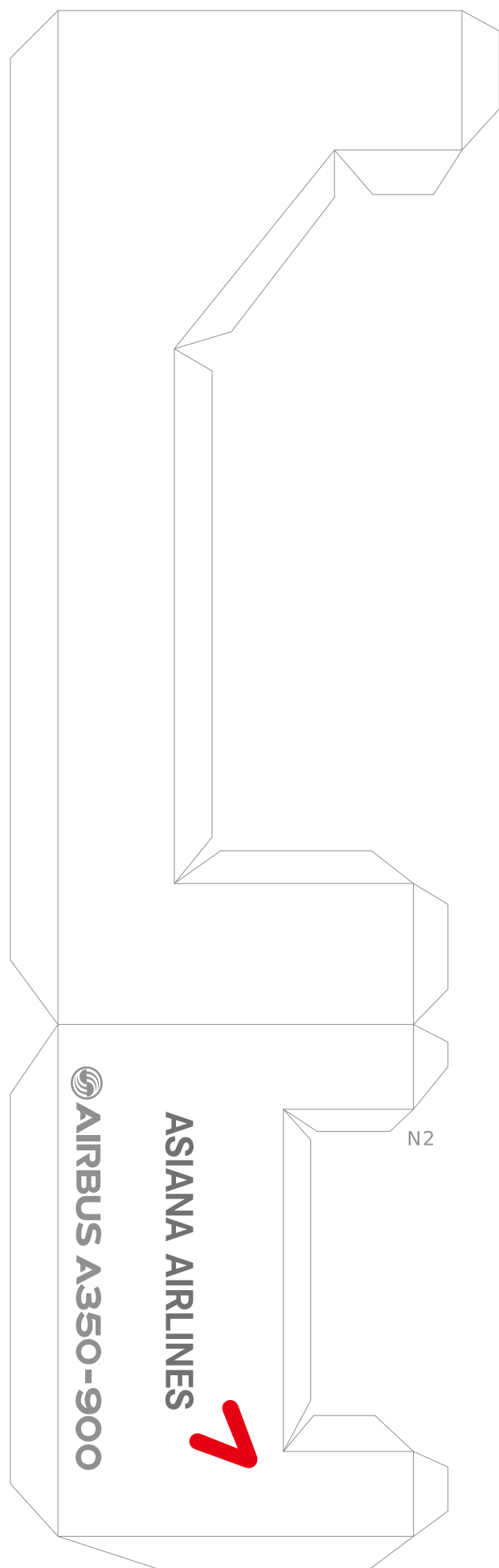
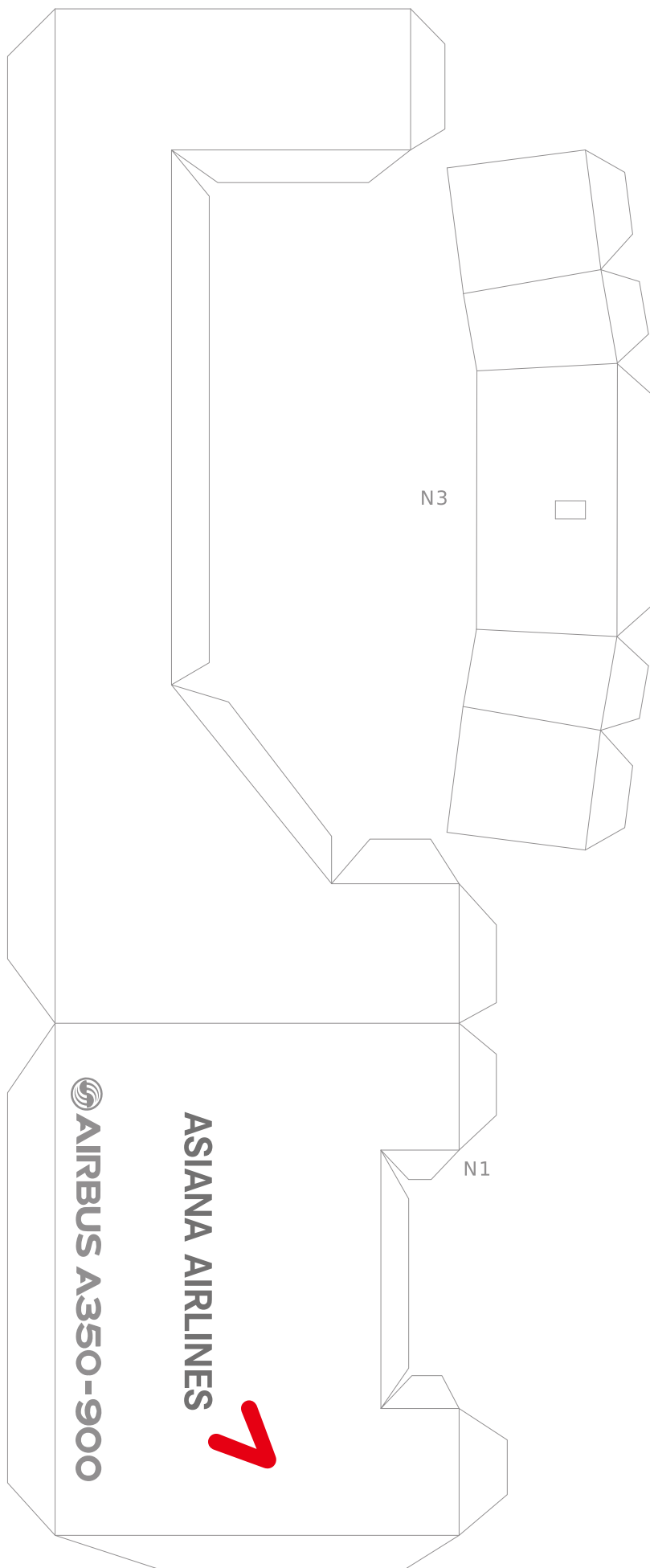



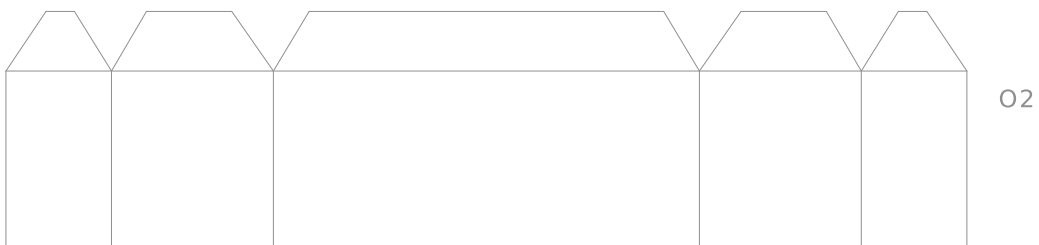

O2

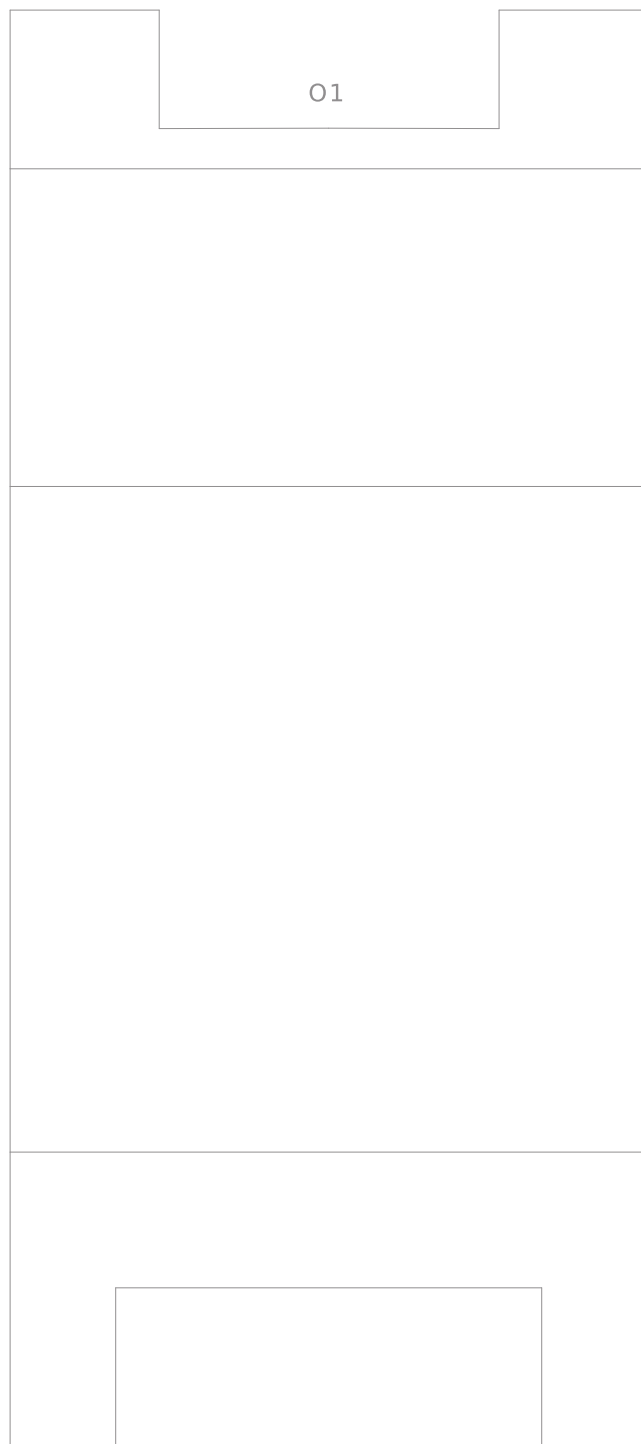

O1

O3

ORIGINAL MODEL DESIGNED BY EDWIN RODRIGUEZ

**HERMERCRAFT**

PLEASE DO NOT SELL THIS FILE | DESIGNED IN PALMARES, COSTA RICA