

A28R

A28L

A11

A10

A9

A7

A6

A26

A8

A5L

A5R

A27

A17L*

A17R*

A14*

A18*

A19*

A4

A24*

A25*

A15*

A21*

A22*

A20*

A24*

A25*

A16*

A23*

A3

A13L*

A13R*

A2

A12*

A1

- B5* 
- B6* 
- B7* 
- B8* 
- B9* 
- B10* 

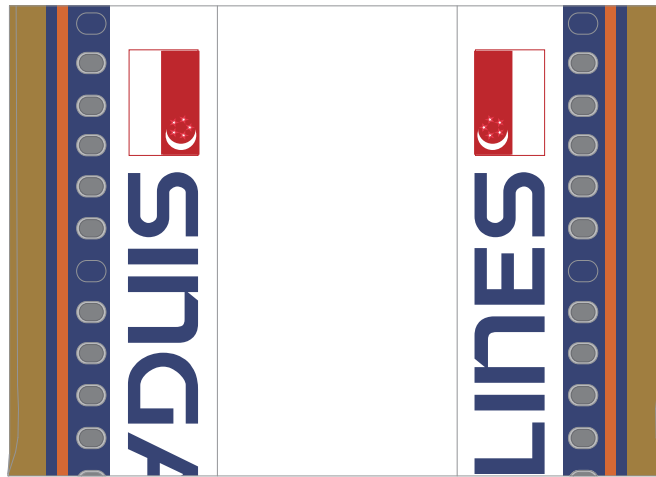
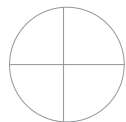
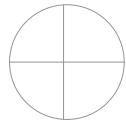

B3

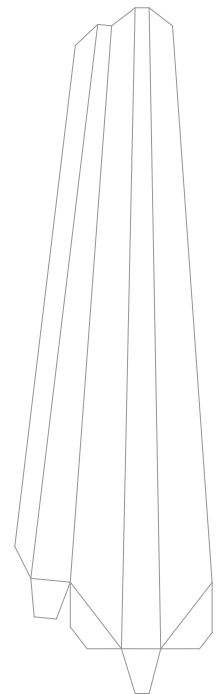

B13

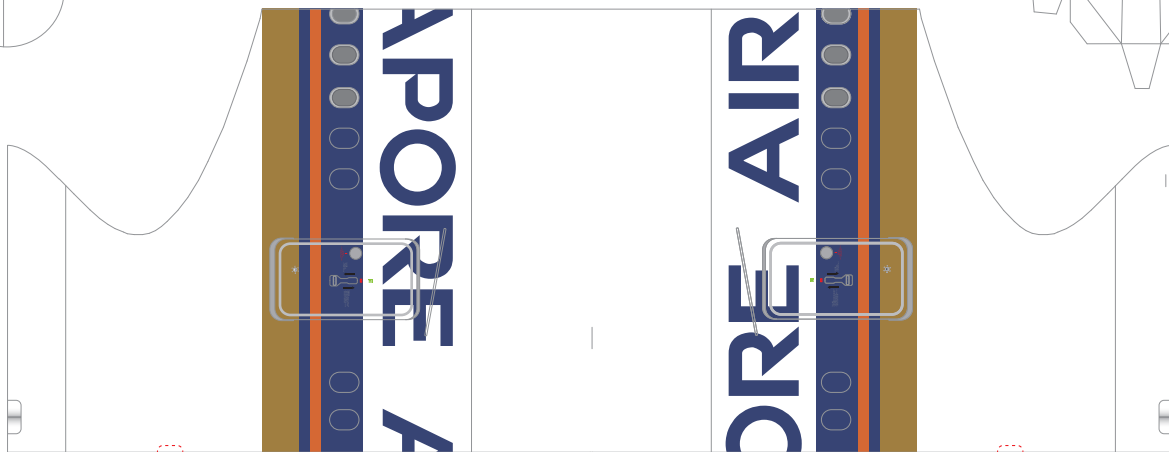

B2

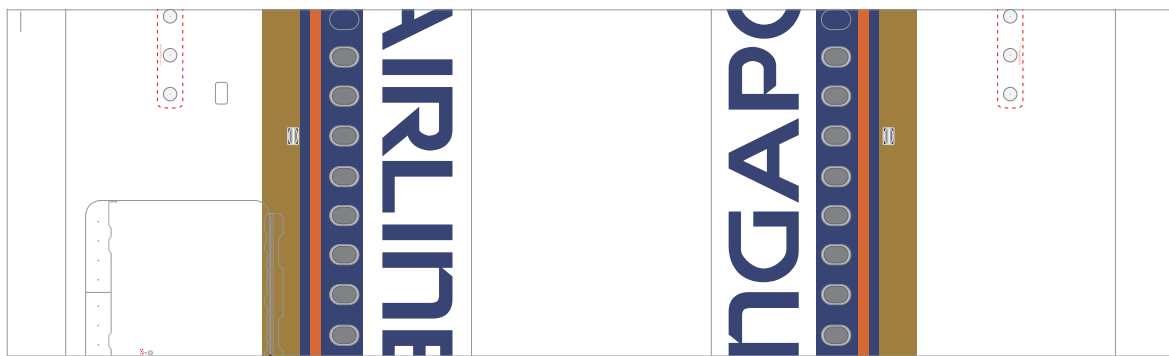

B1



B12R



B11



B12L

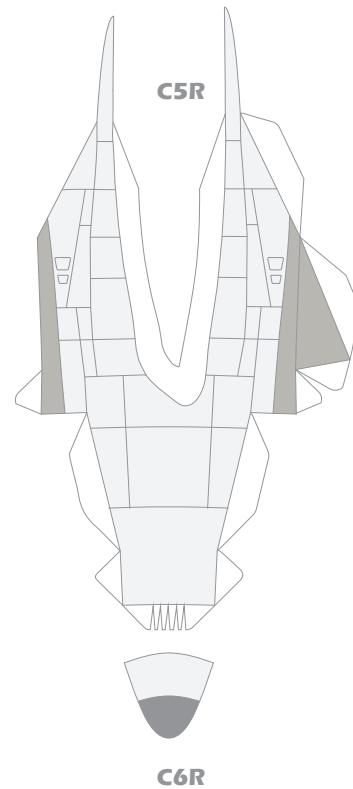
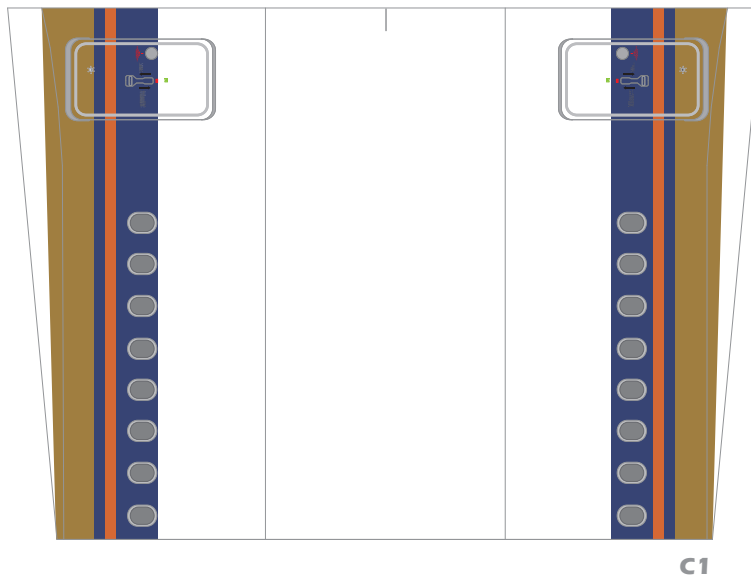
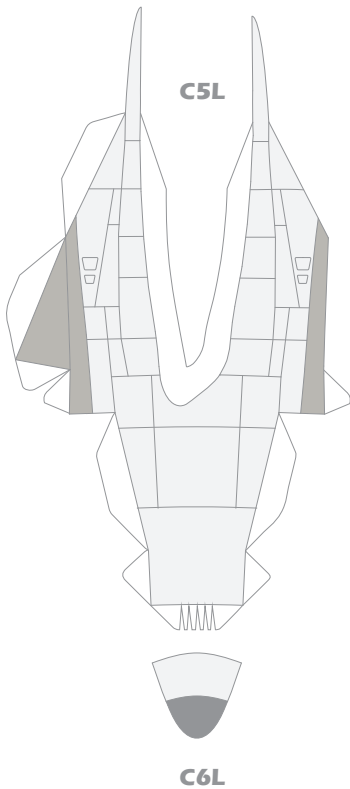
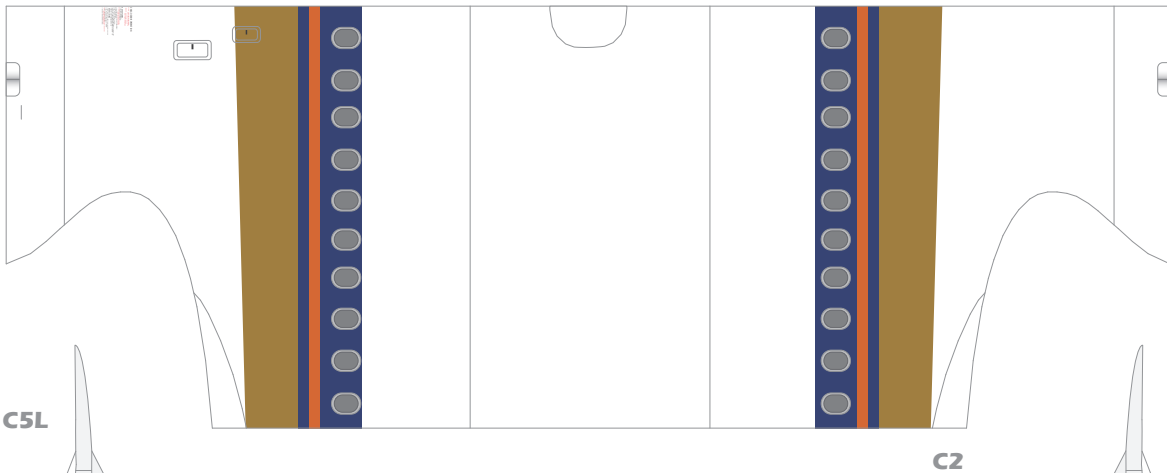
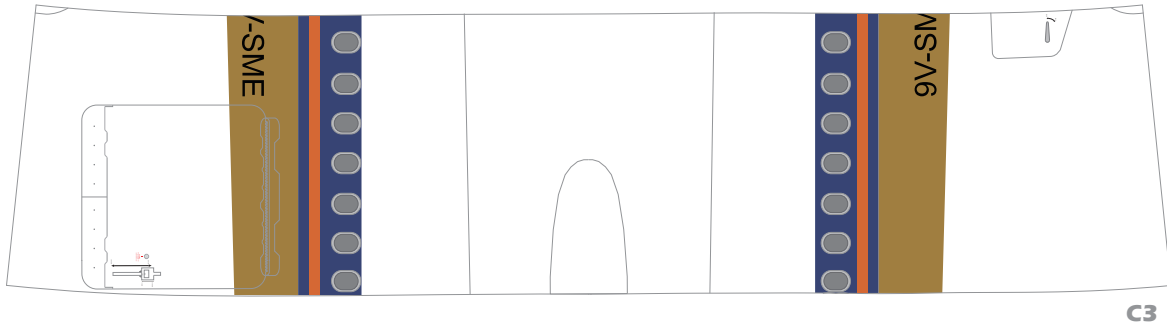
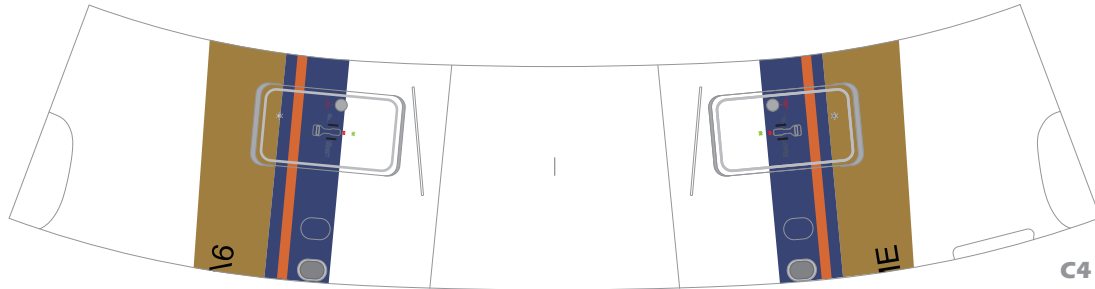

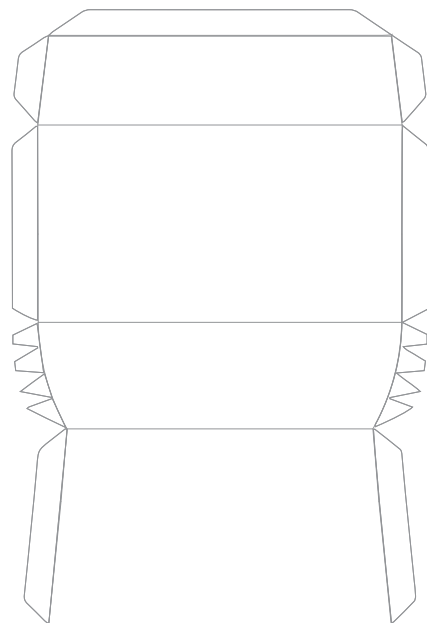
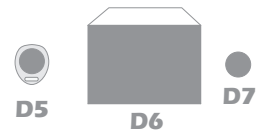
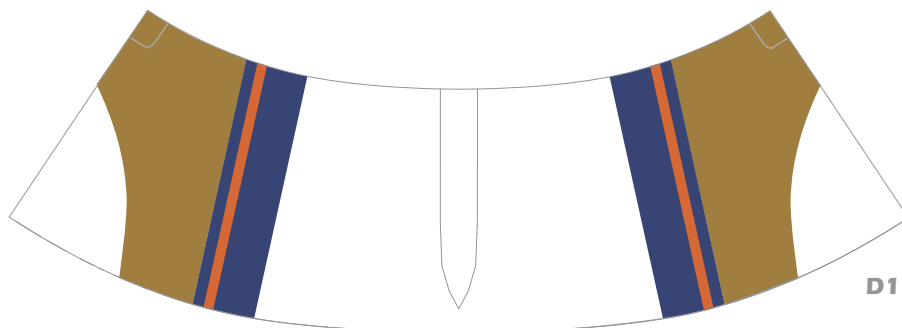
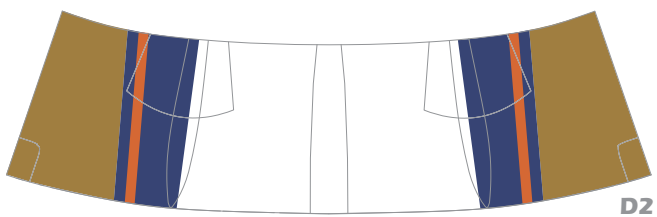
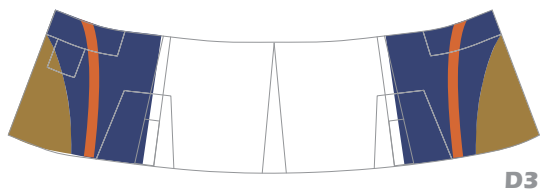
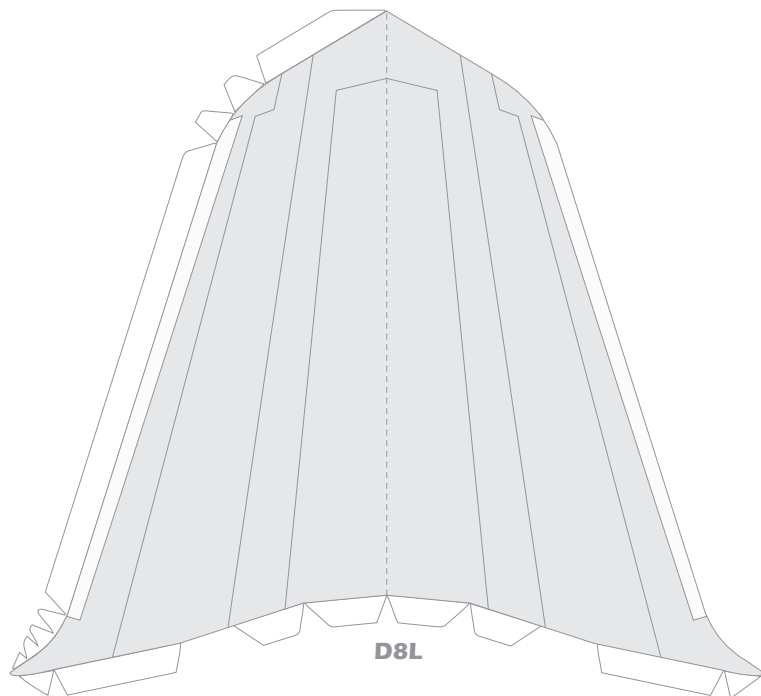
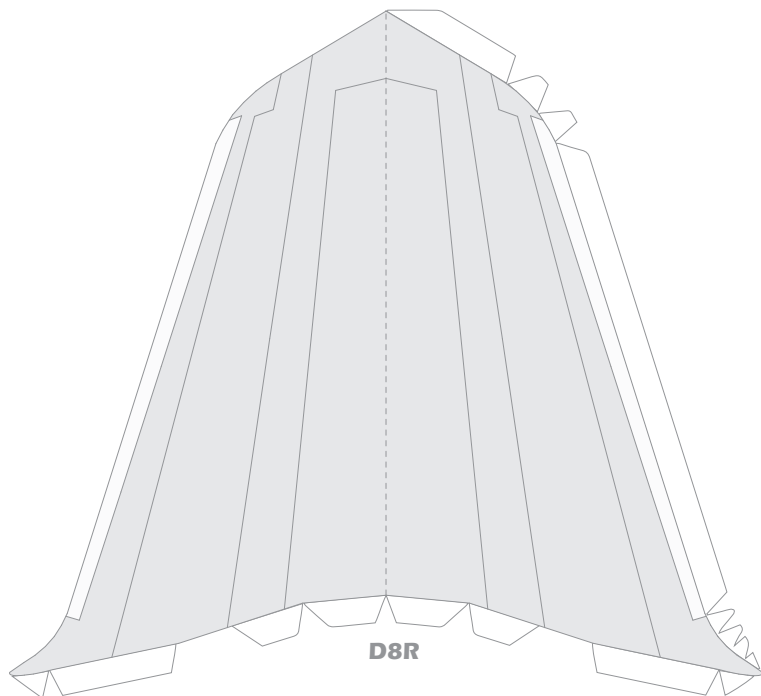

D9

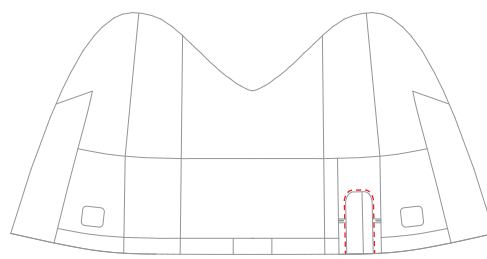
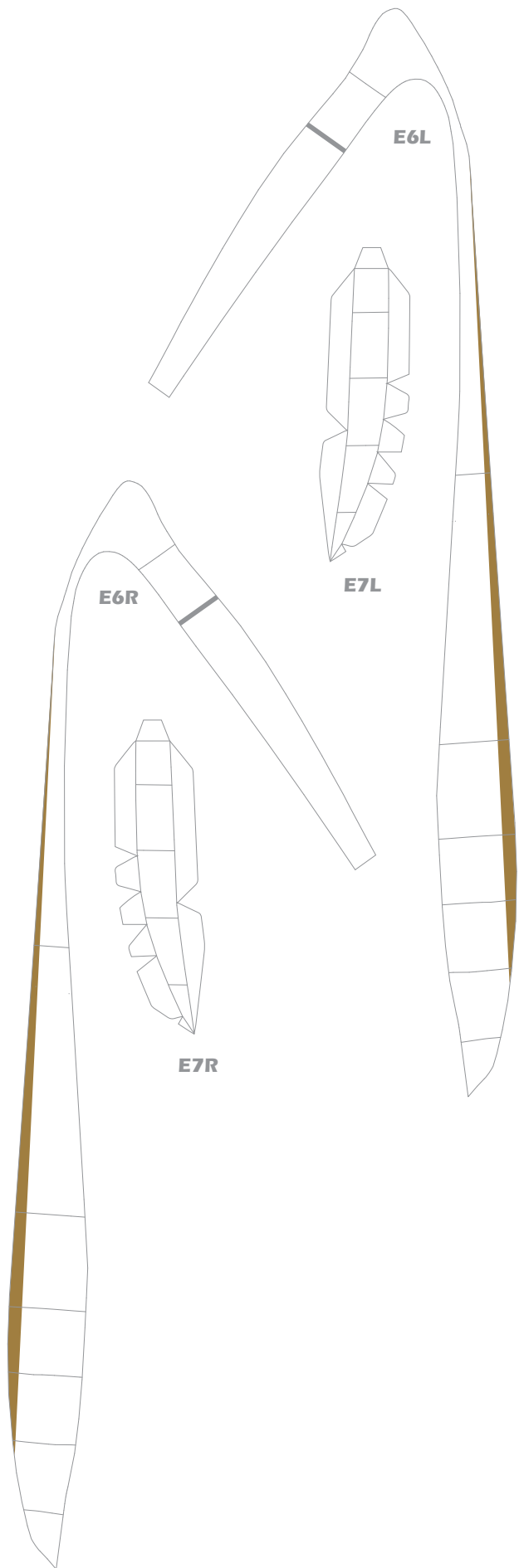

E5

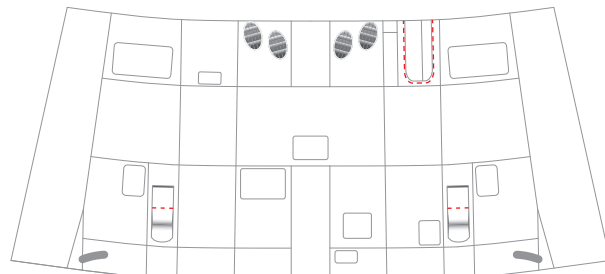

E4

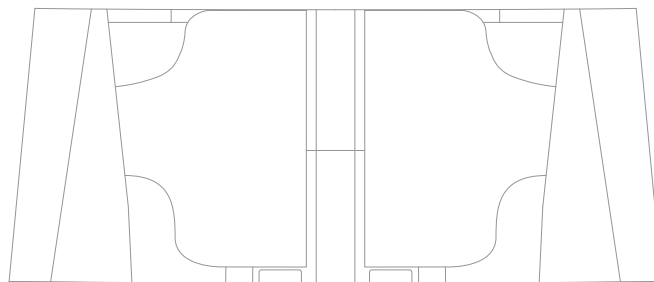

E3

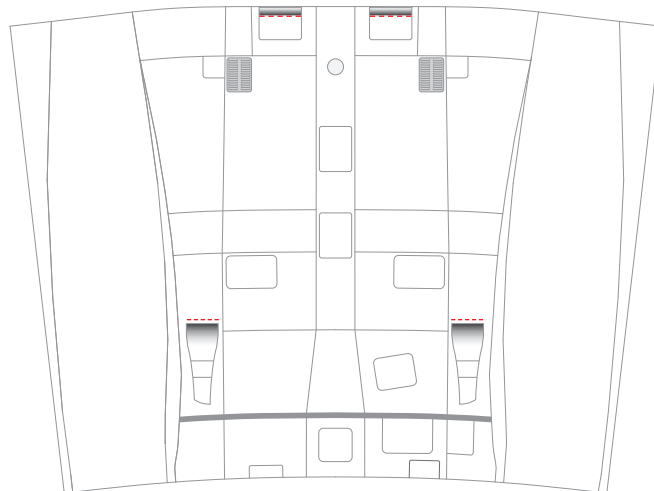

E2

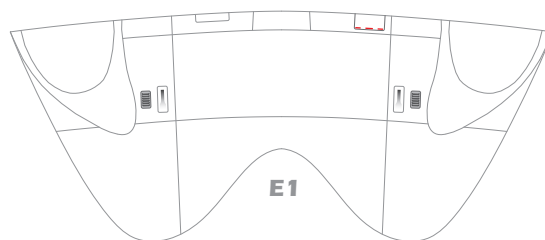

E1

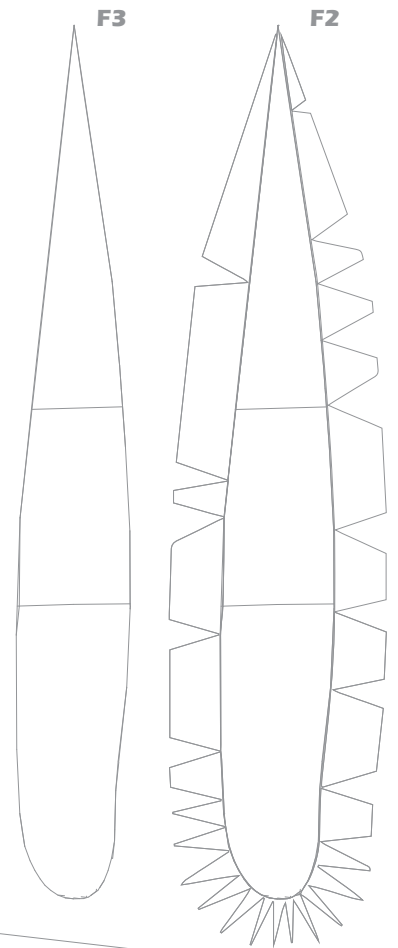
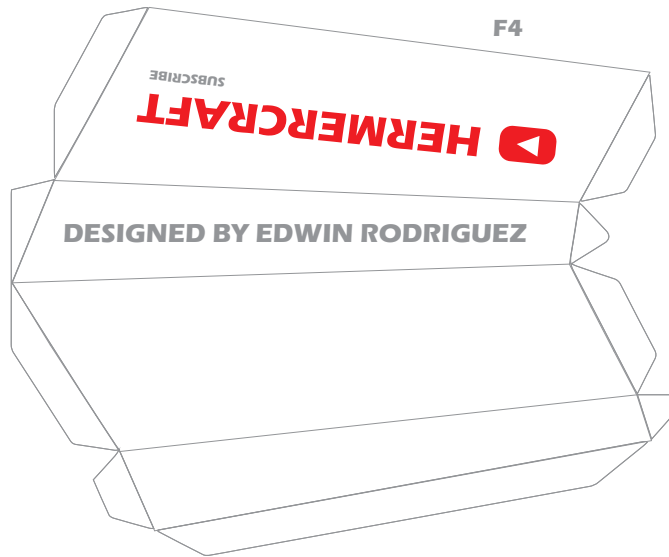
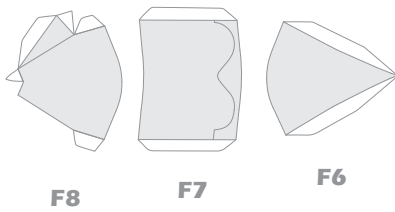
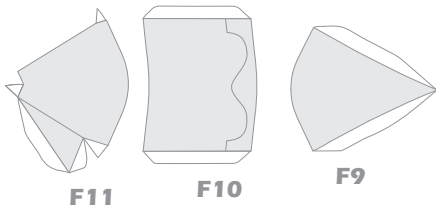
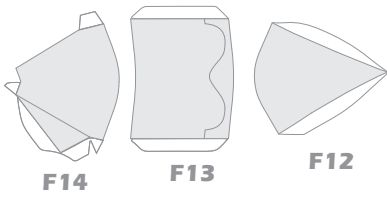
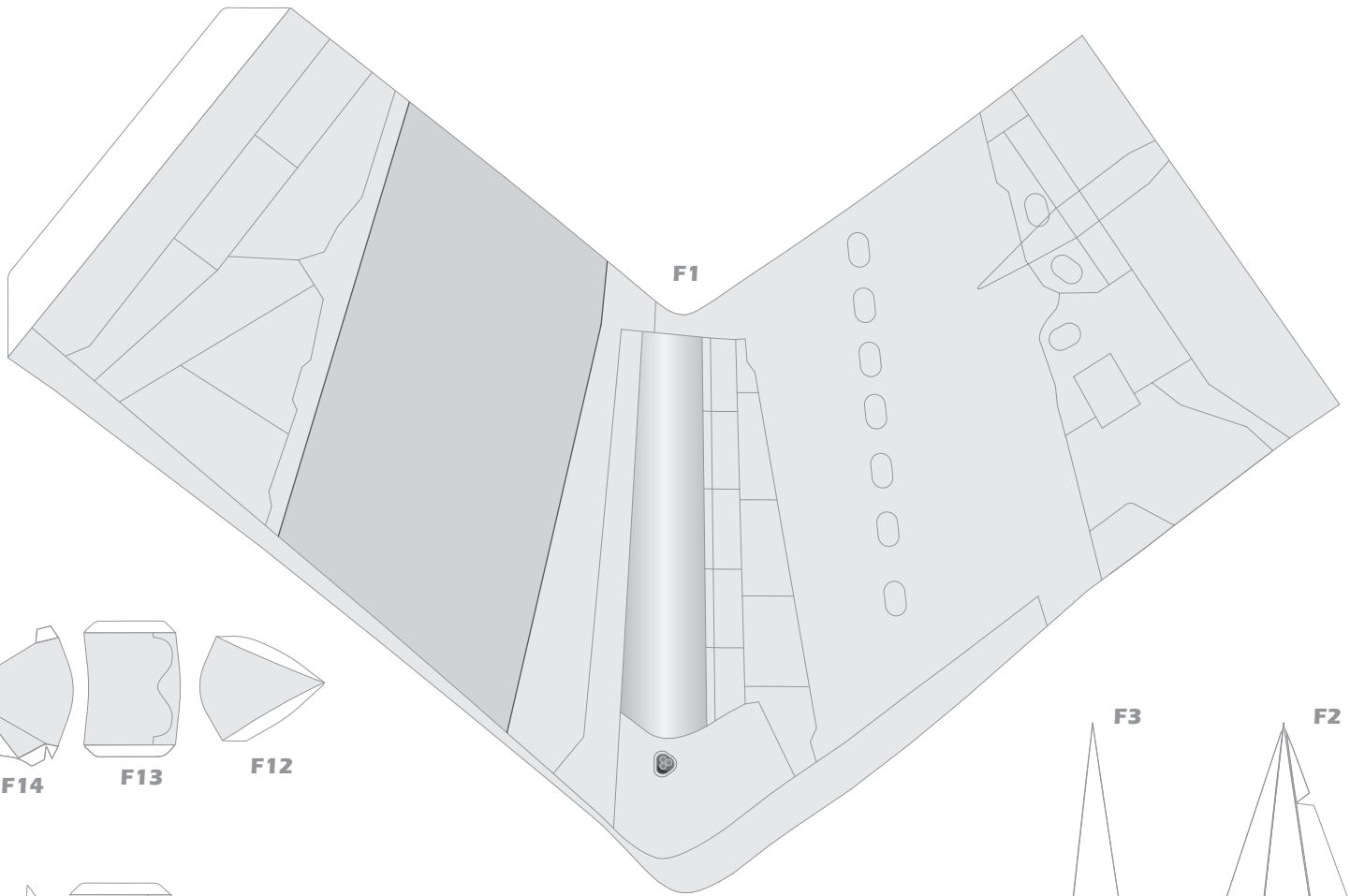

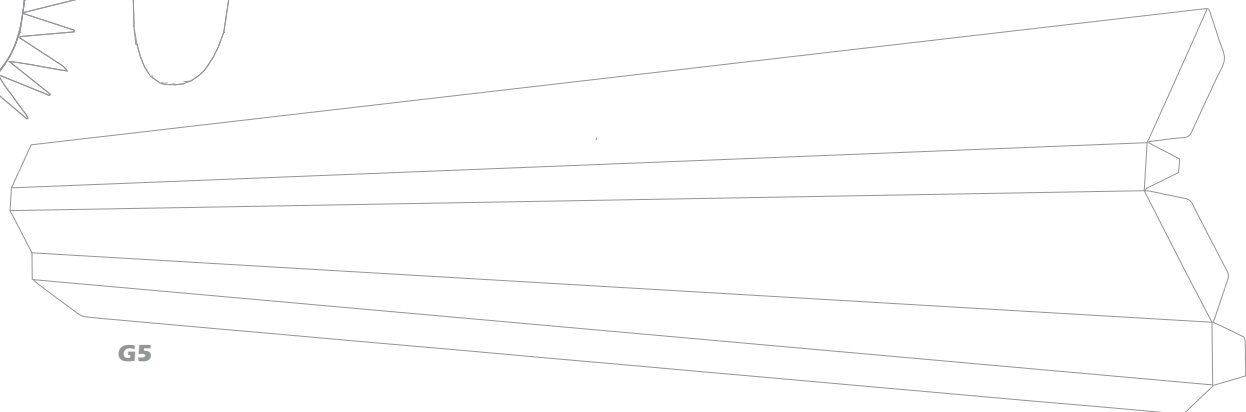
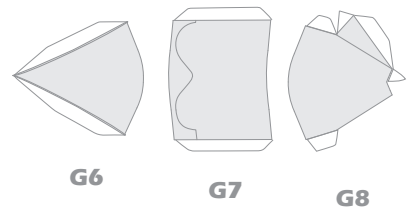
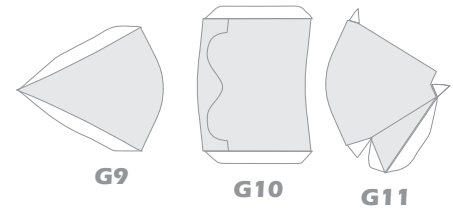
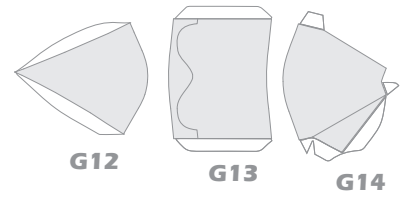
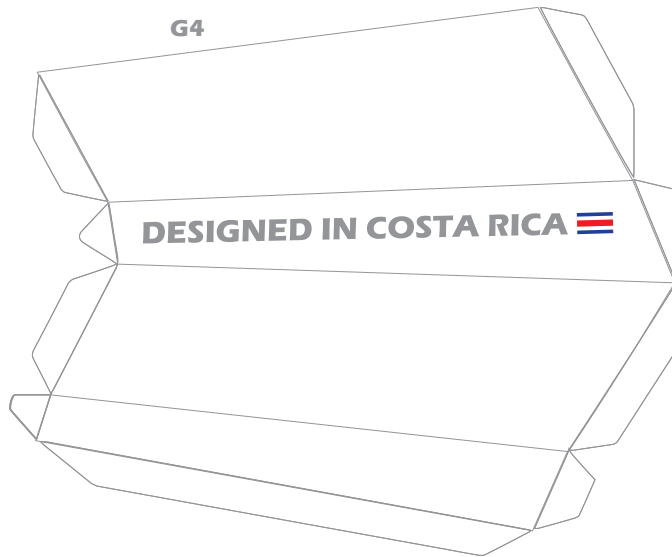
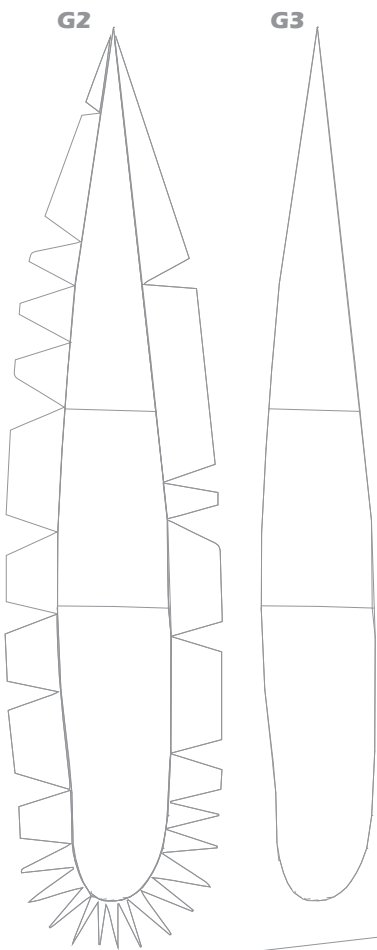
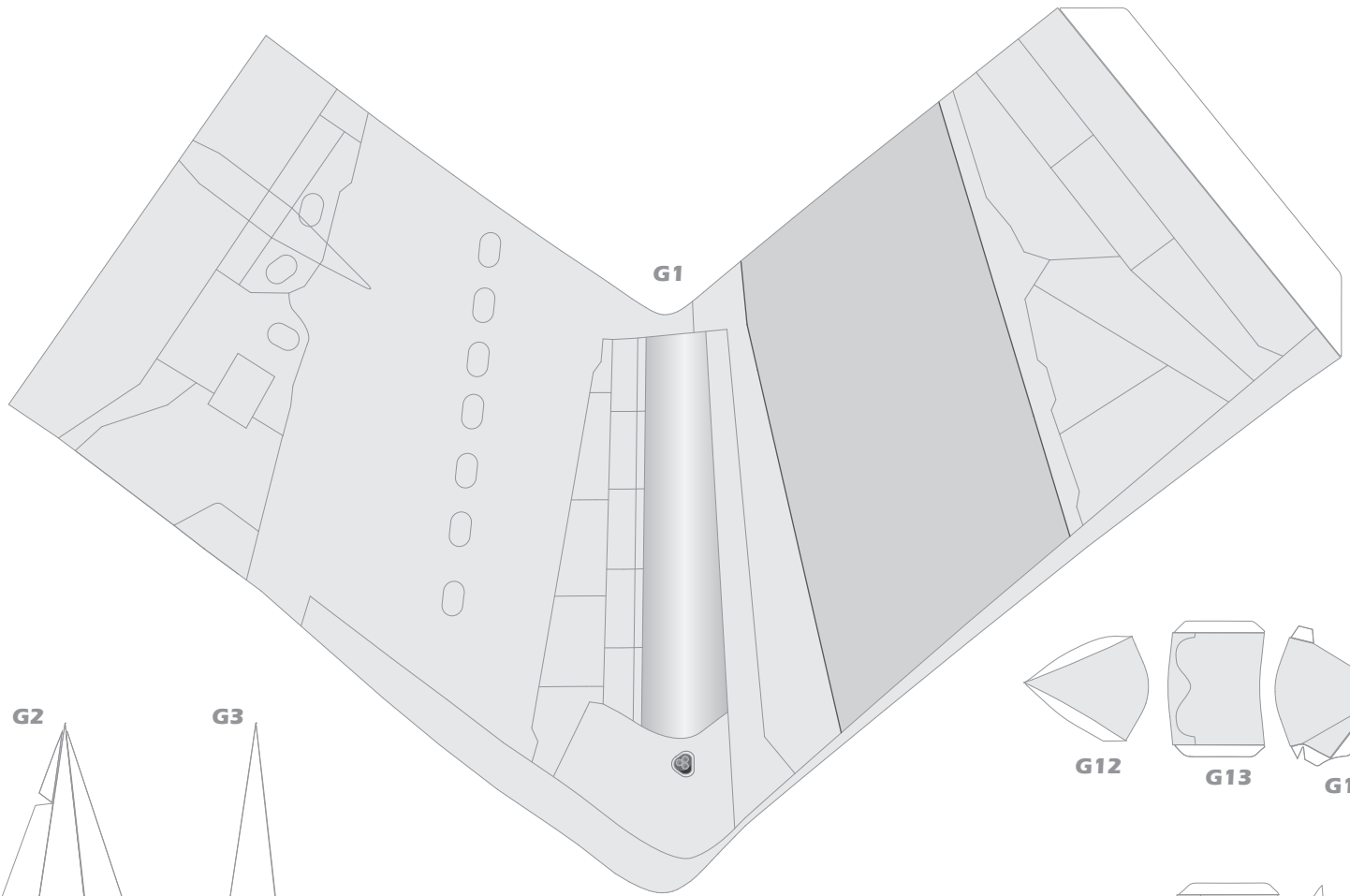

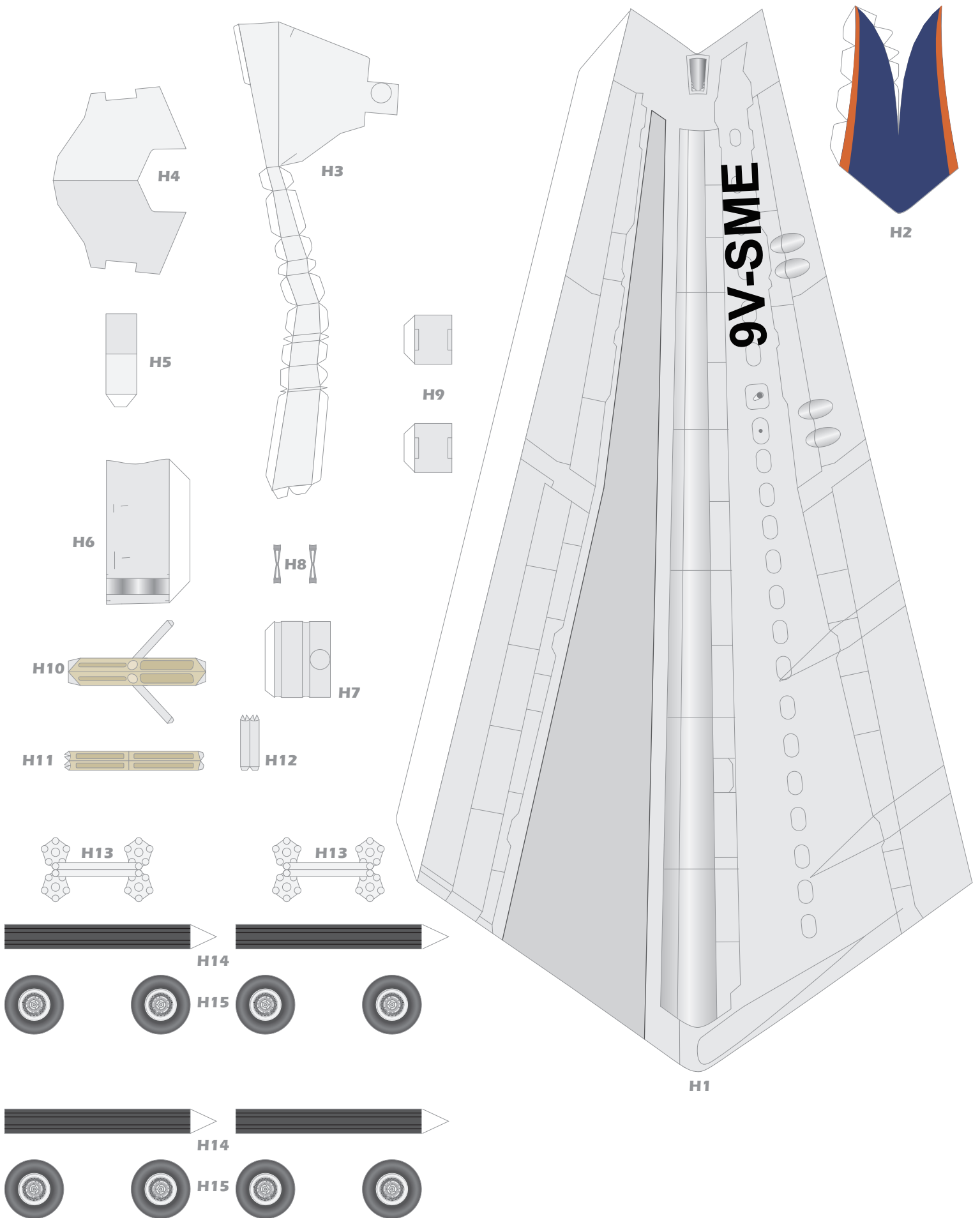

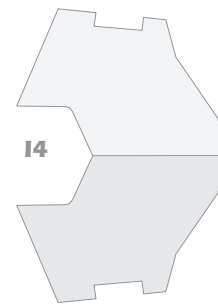
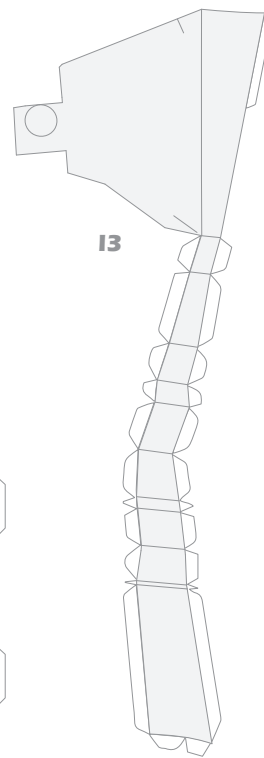
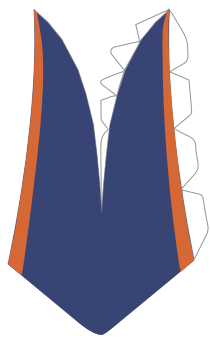
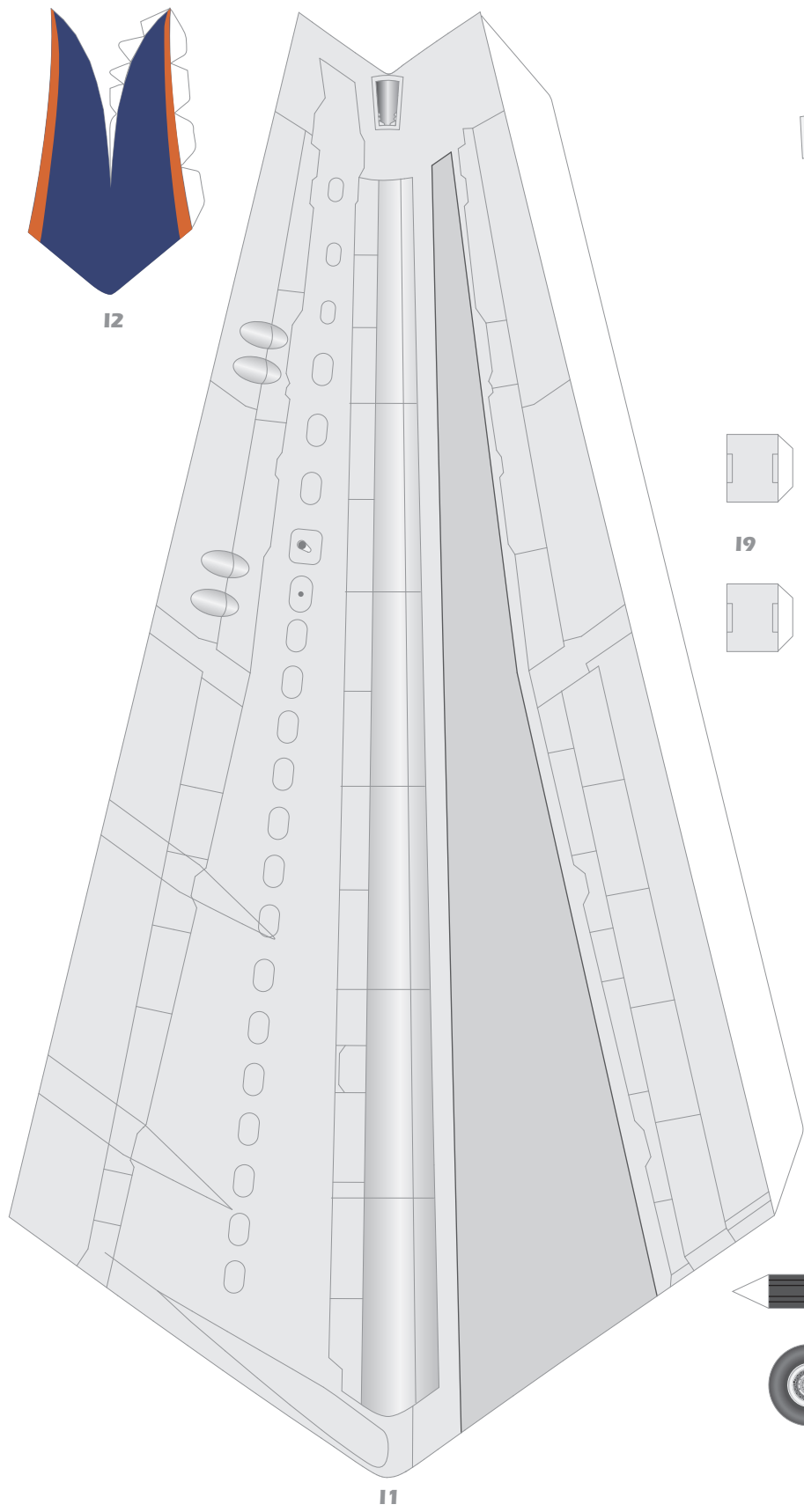

19



15



16

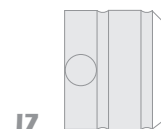

17

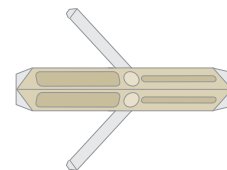

112



111

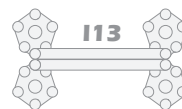

114



114



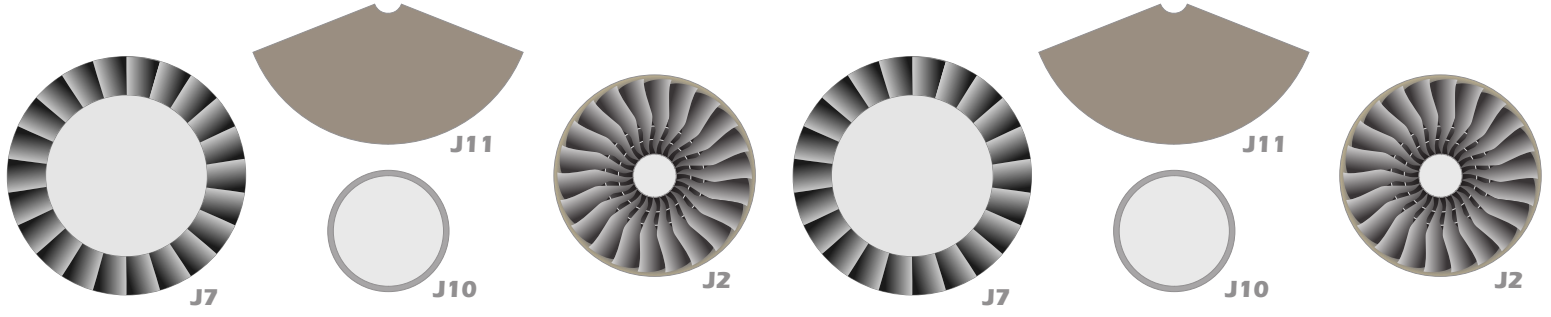
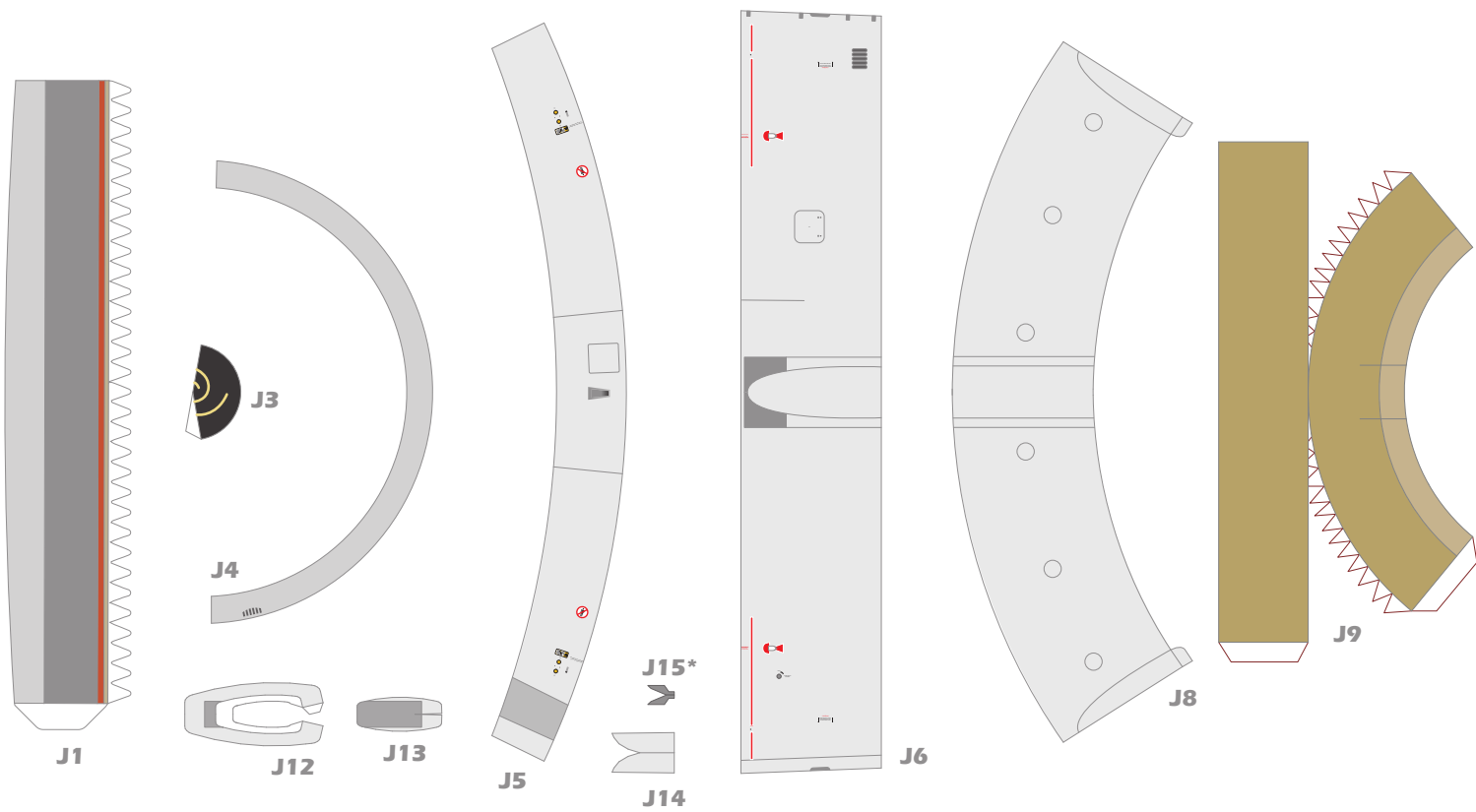
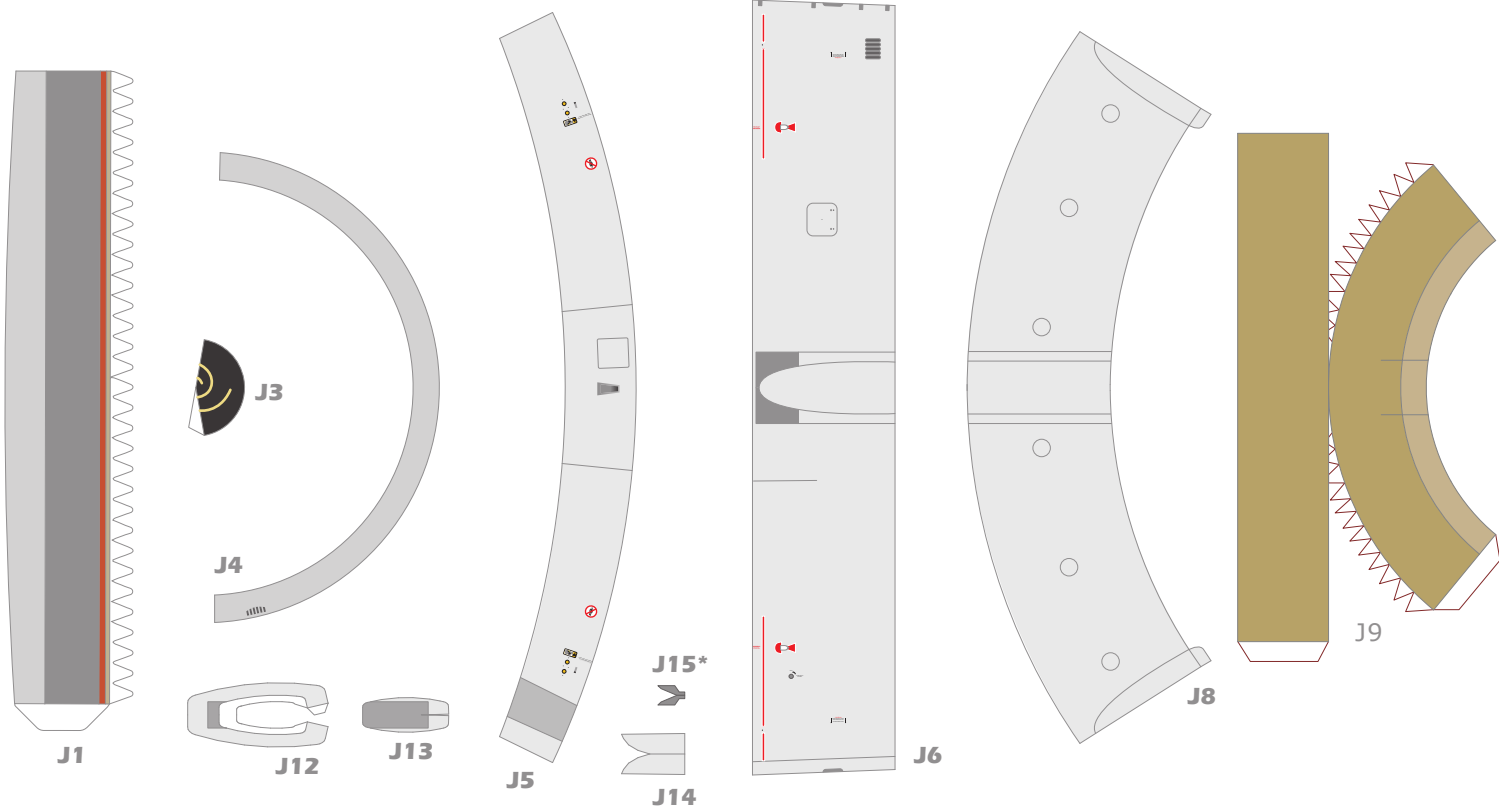

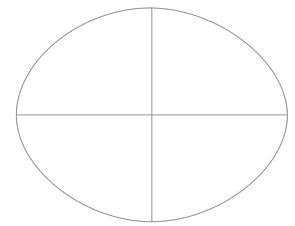
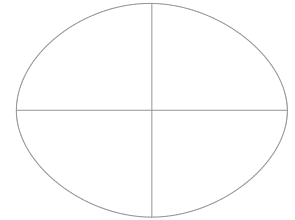
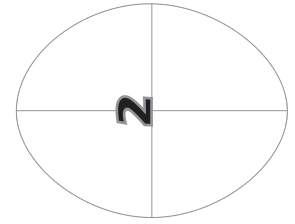

K2

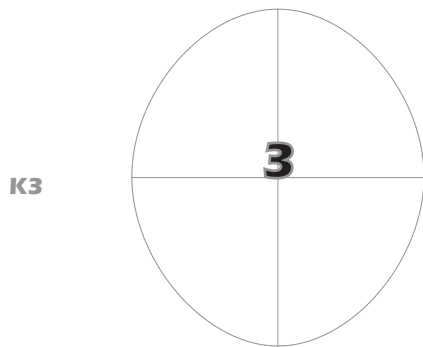

K3

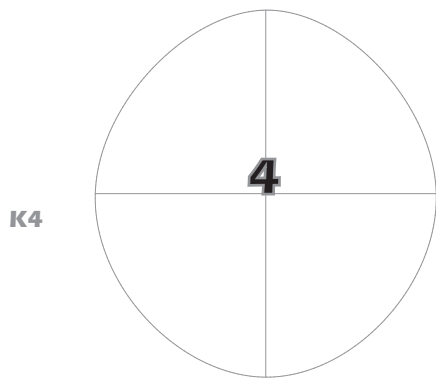
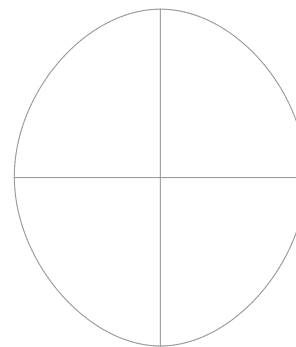
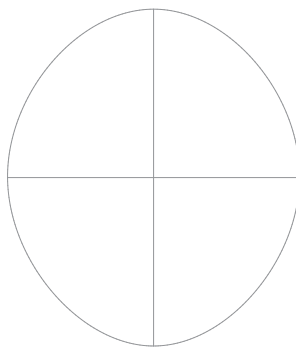

K4

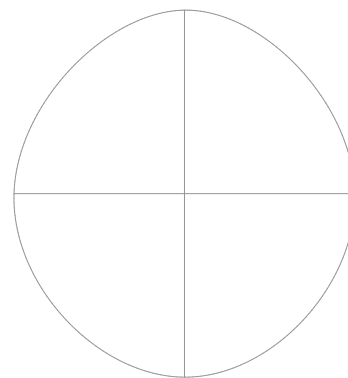
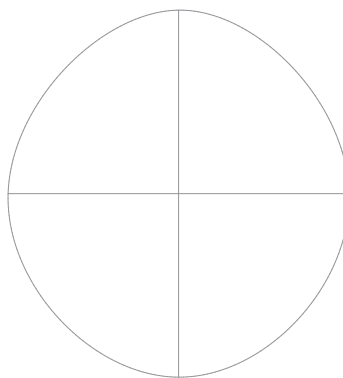

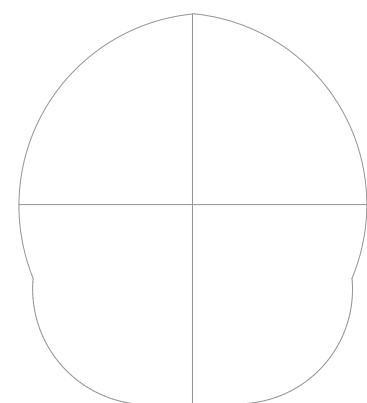
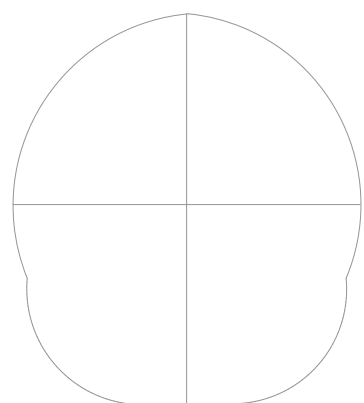
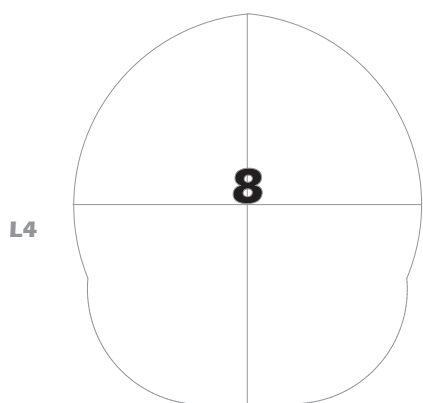
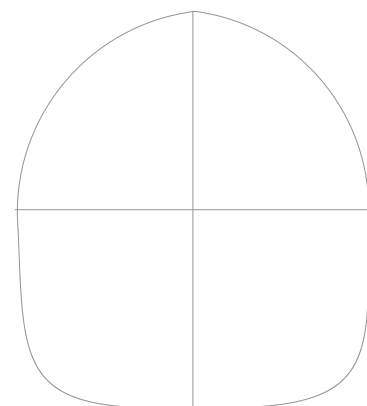
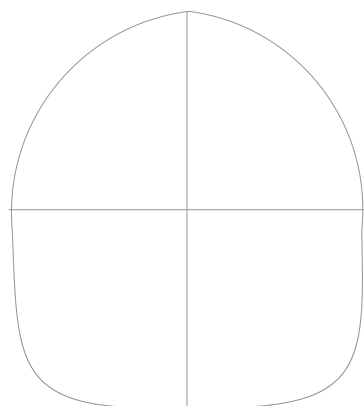
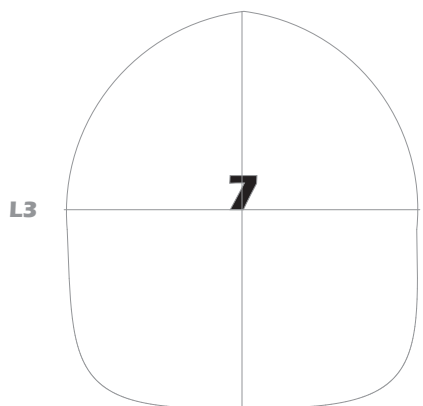
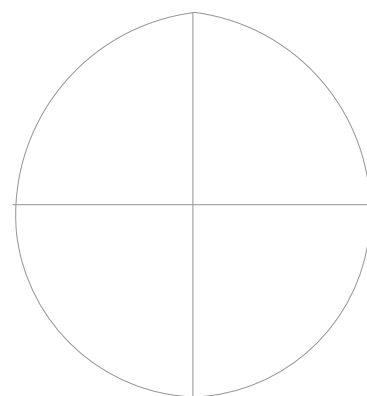
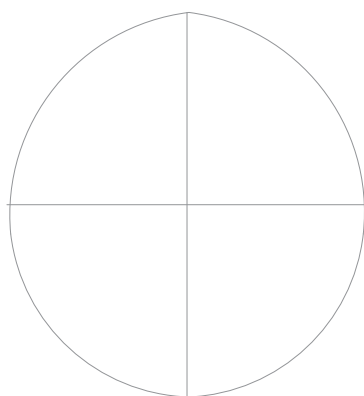
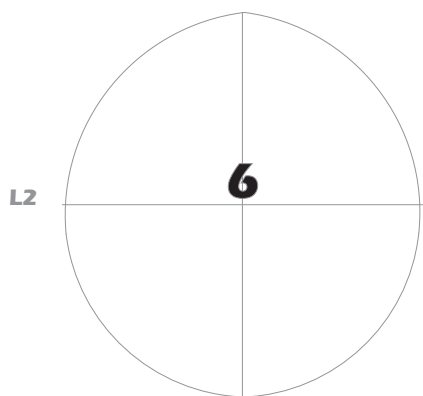
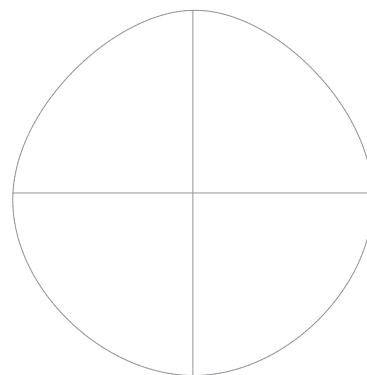
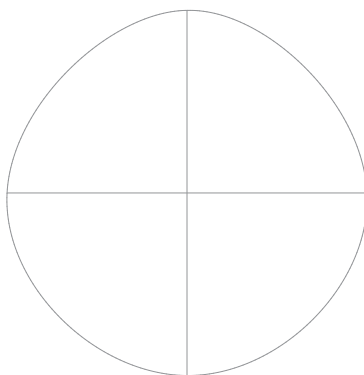
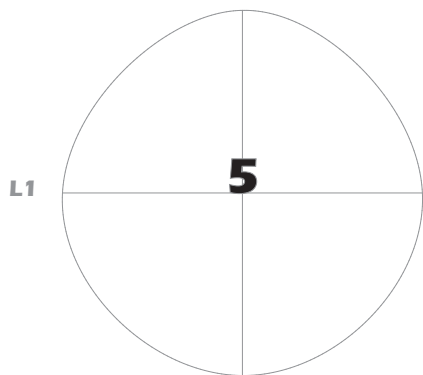

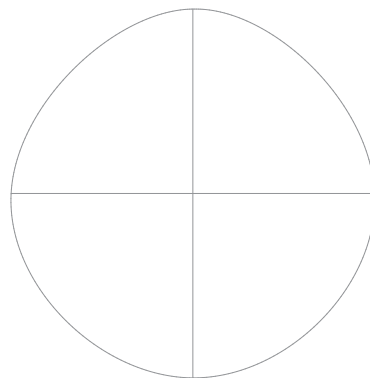
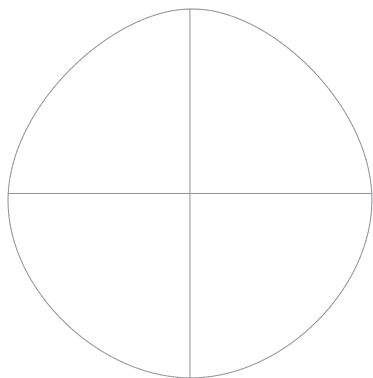
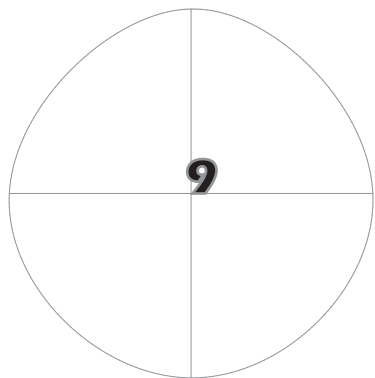

M1

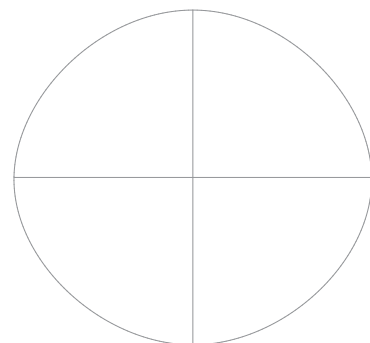
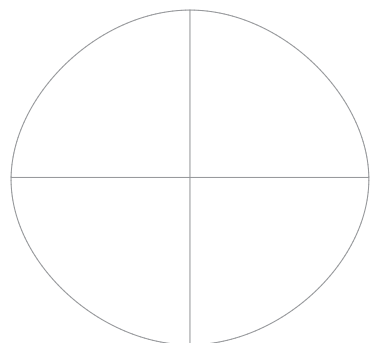
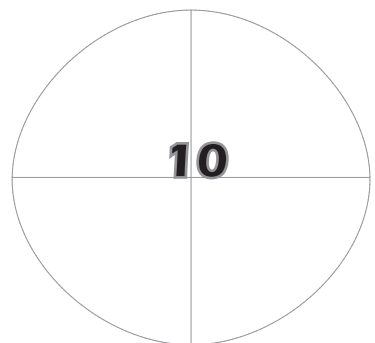

M2

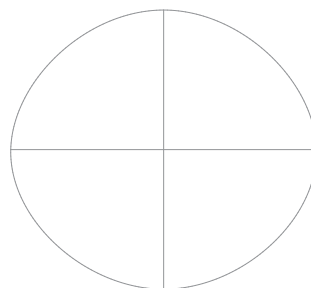
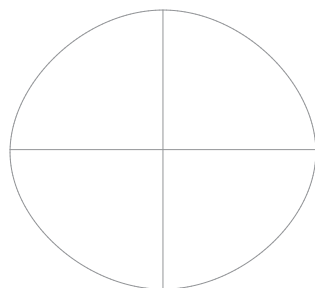
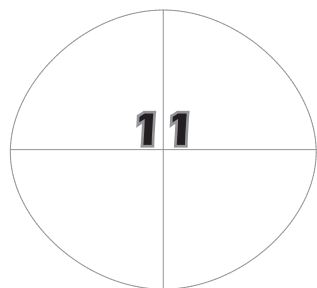

M3

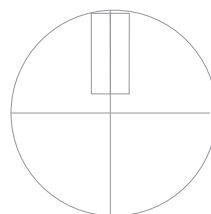
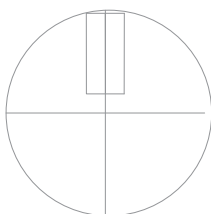
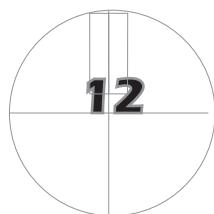

M4

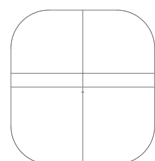
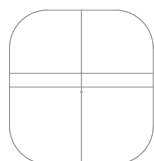

M5

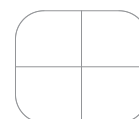
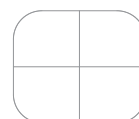

M6

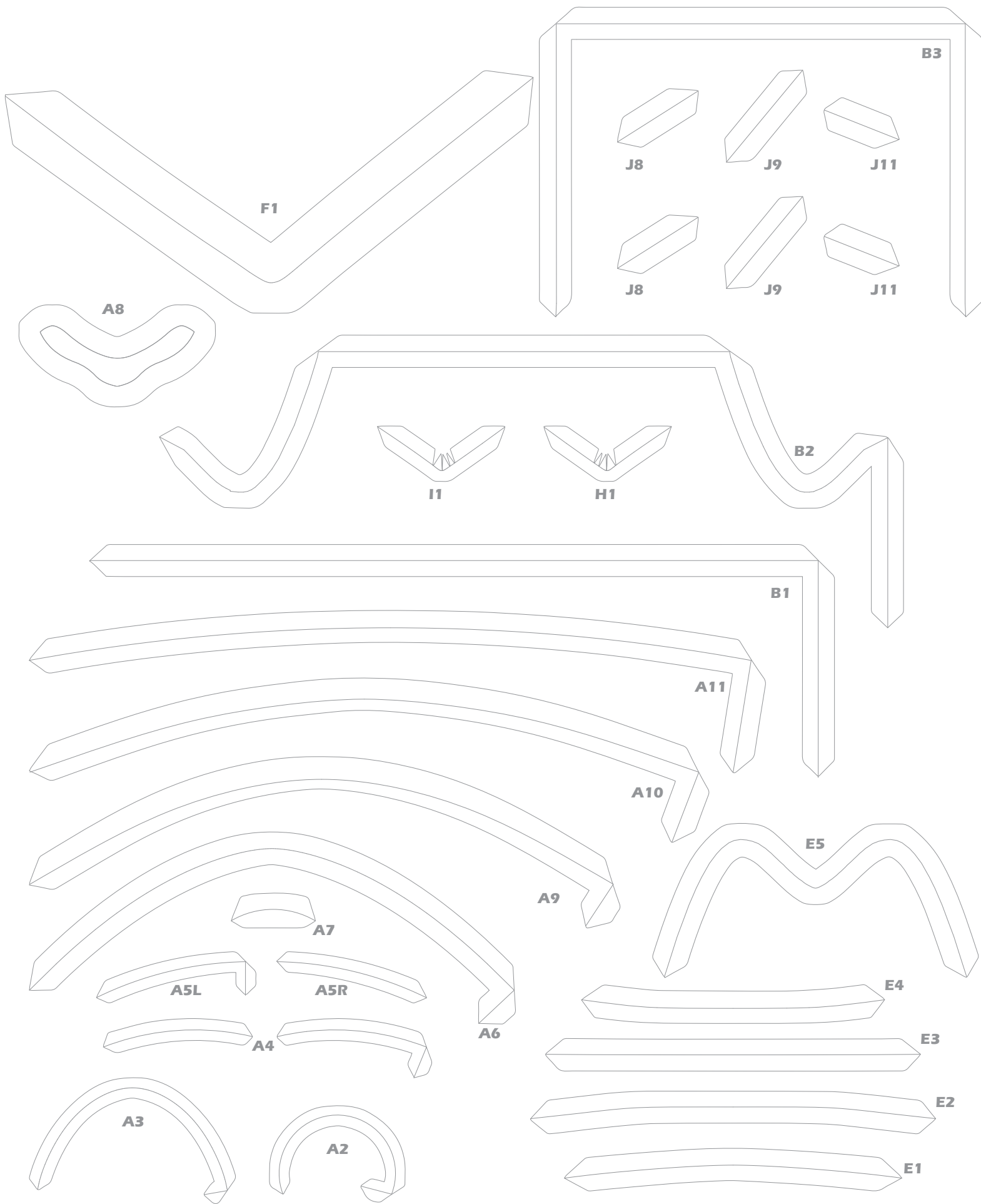

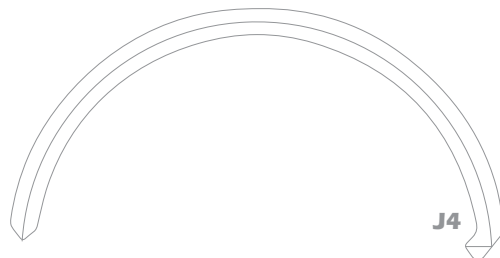
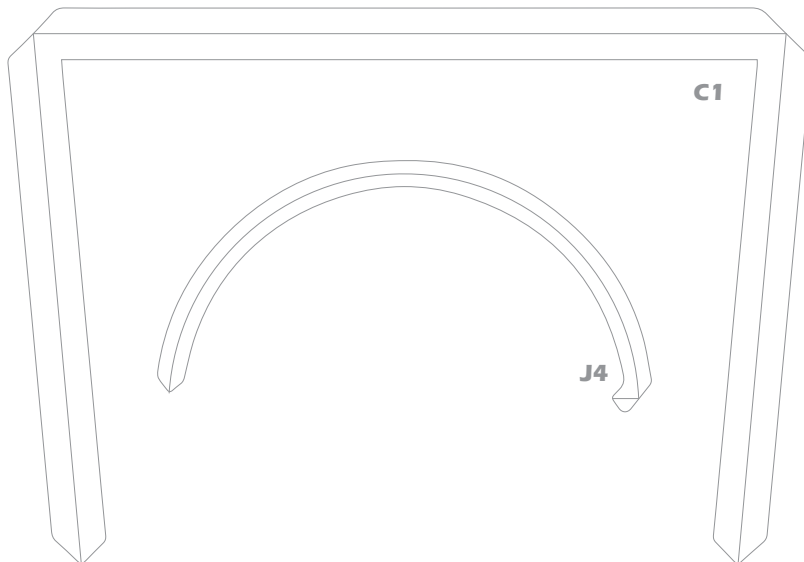
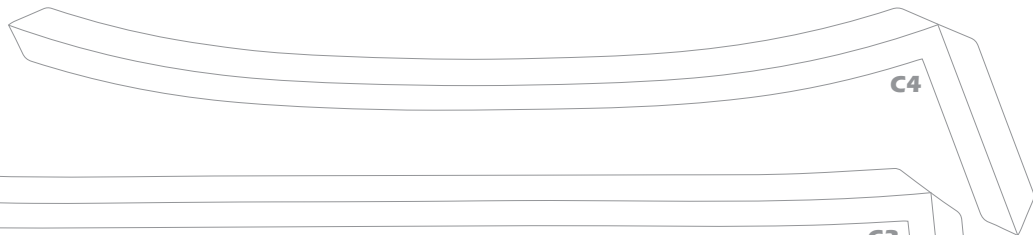
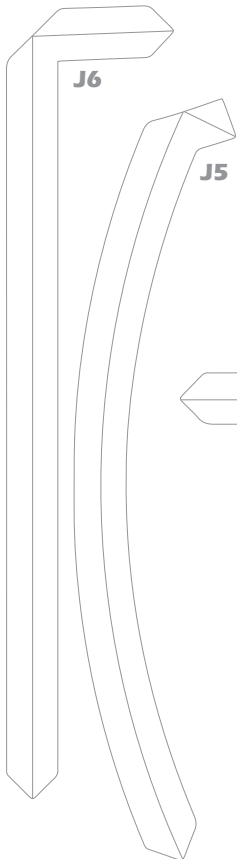
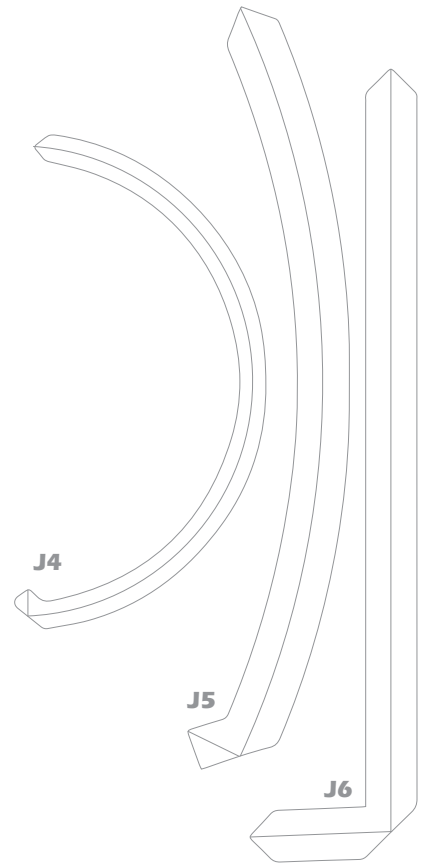
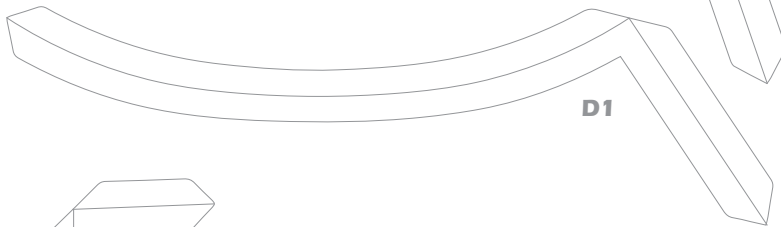
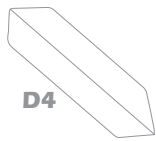
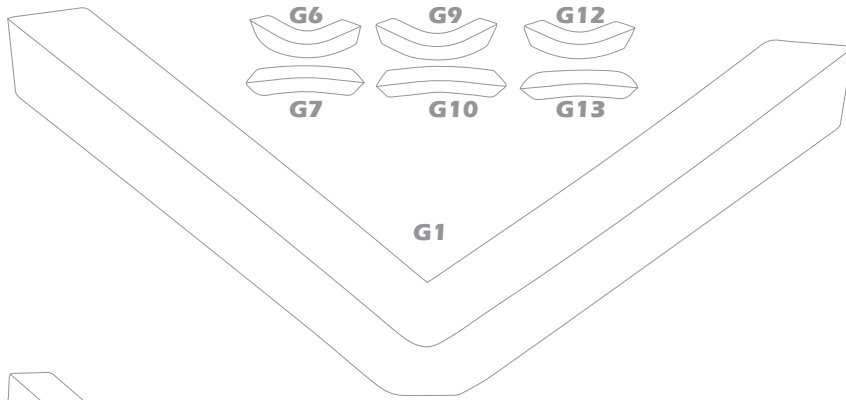
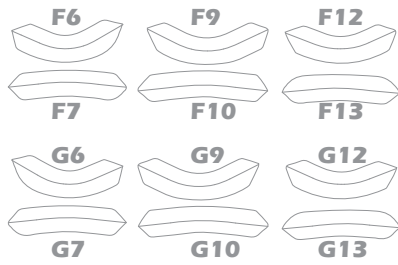

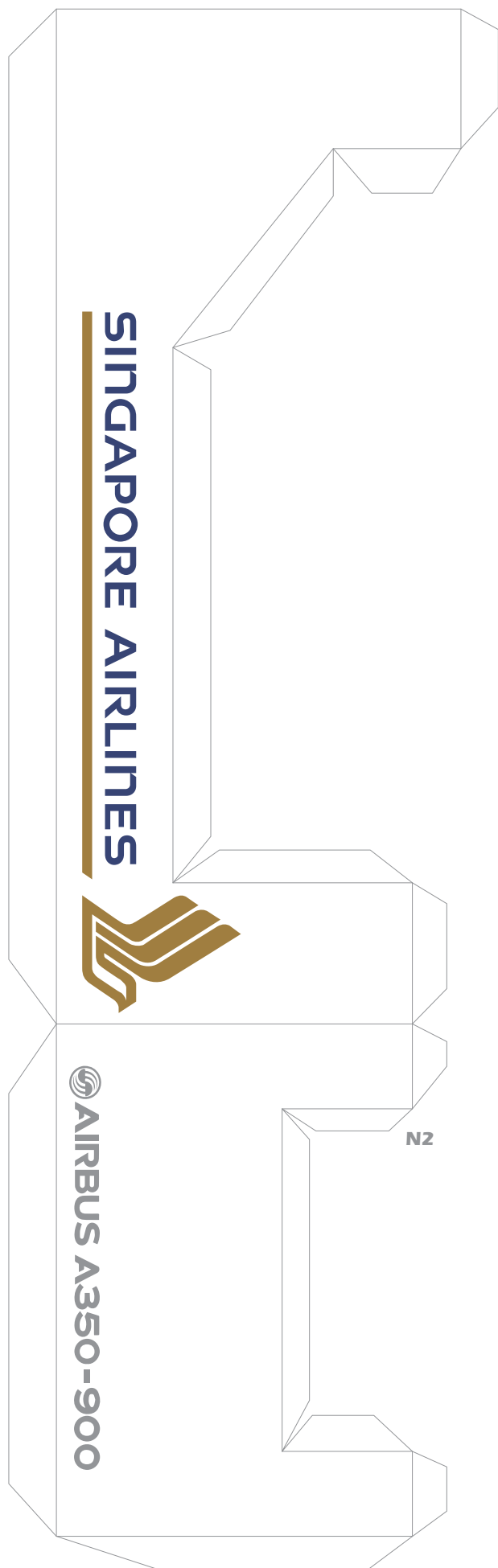
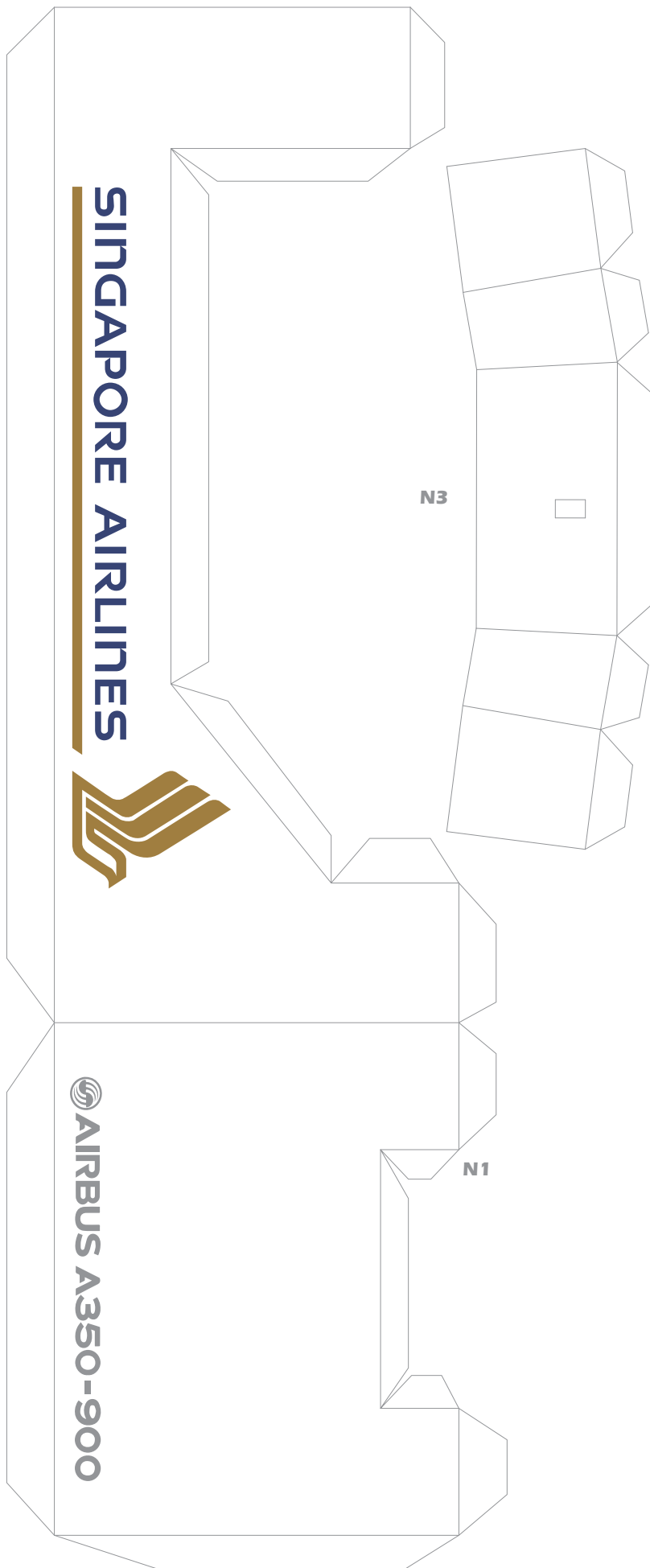

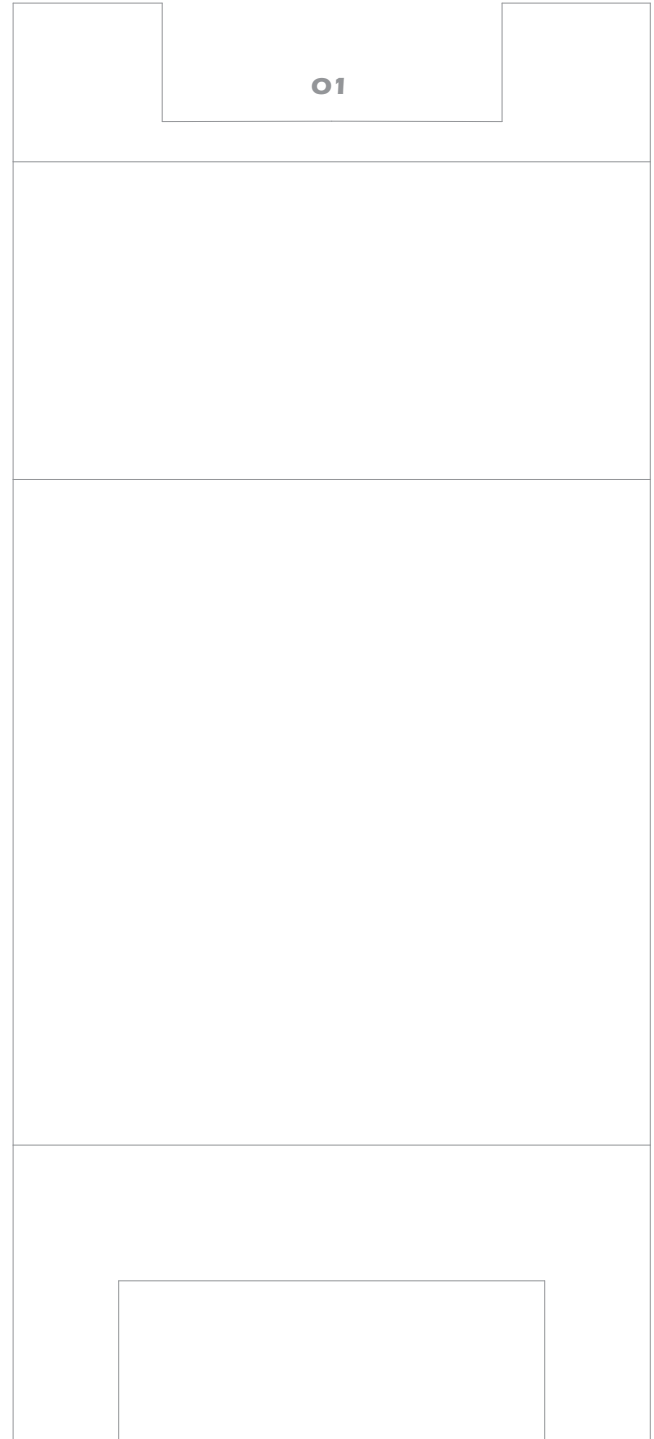

O3

PLEASE DO NOT SELL THIS FILE | DESIGNED IN PALMARES, COSTA RICA

HERMERCRAFT

ORIGINAL MODEL DESIGNED BY EDWIN RODRIGUEZ