

- A20
- A21
- A22
- A23
- A24L
- A24R

Blank space for 787-10 variant

**Instructions**

Scan

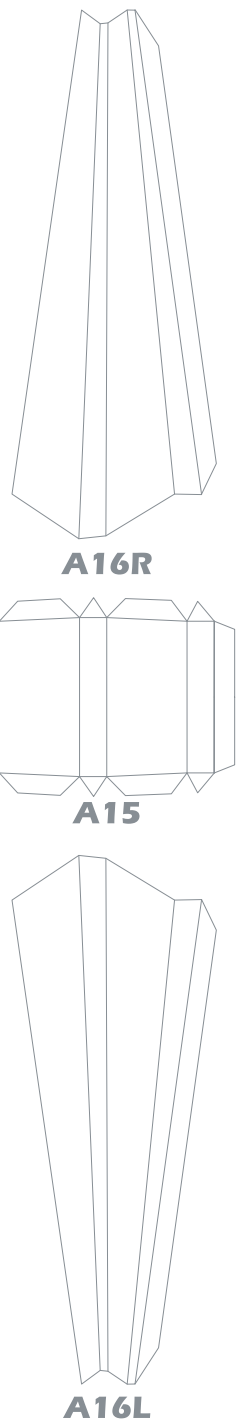

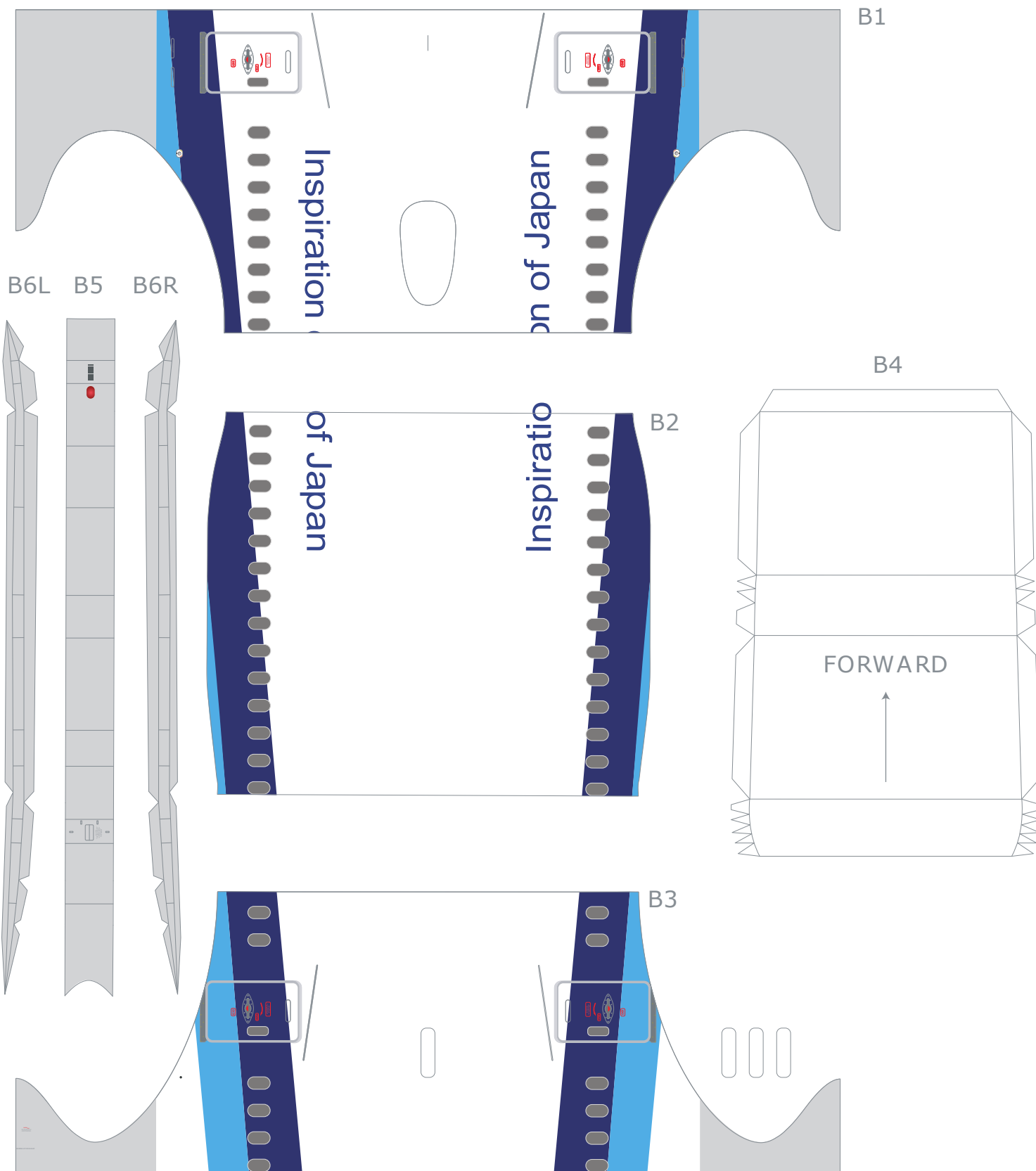

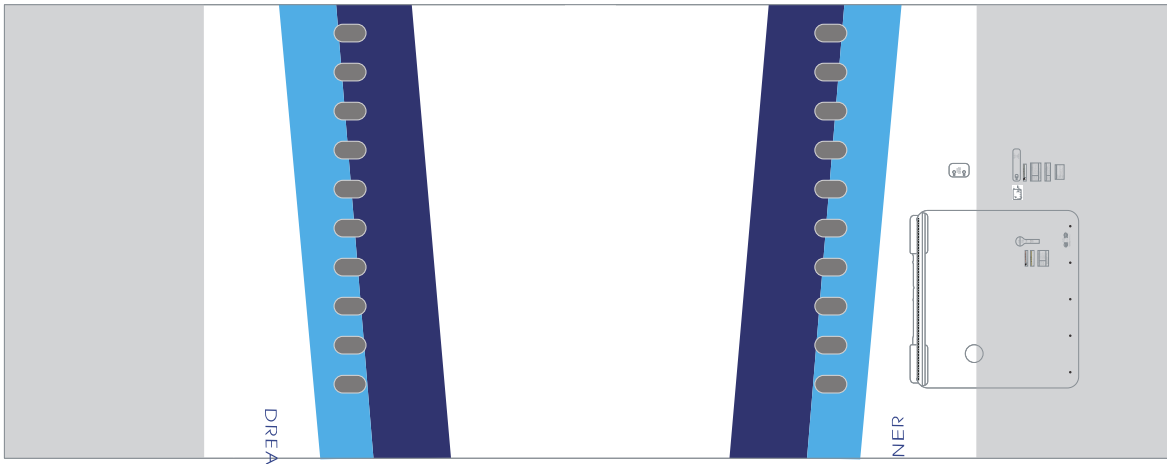

Blank space for 787-10 variant

C1

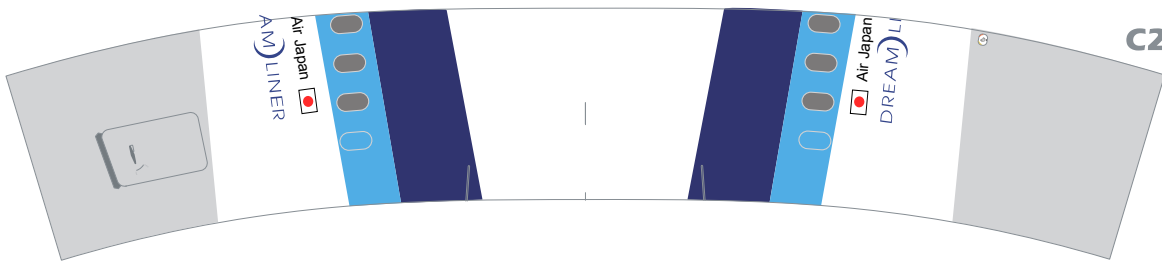
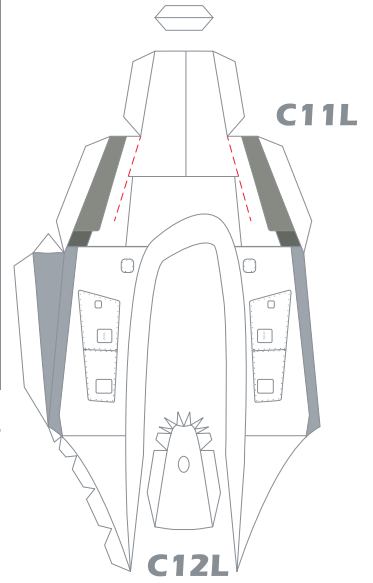

C2

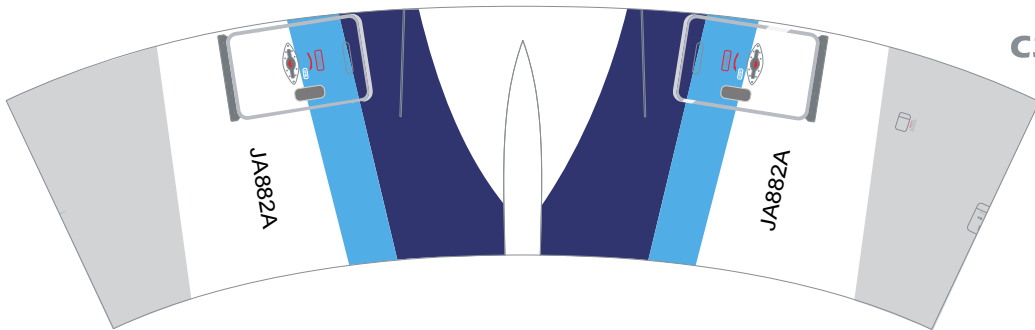
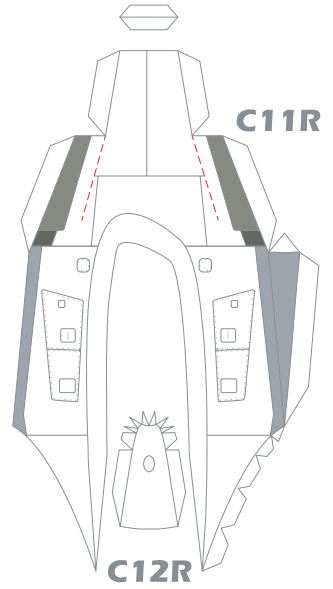

C3

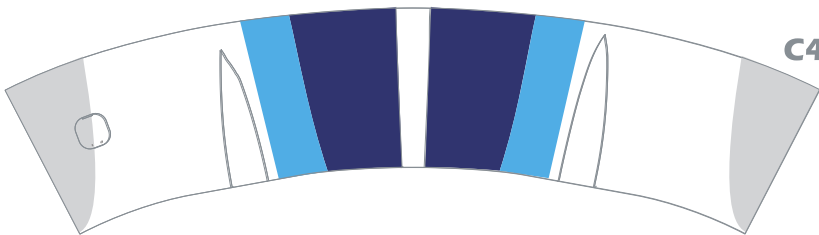

C4

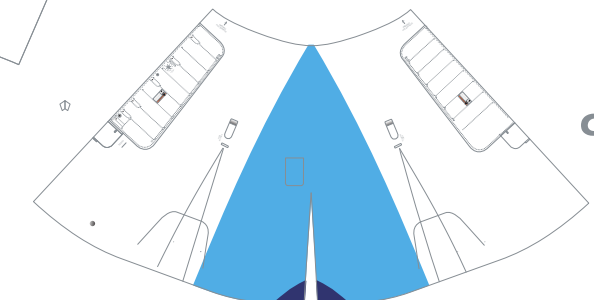
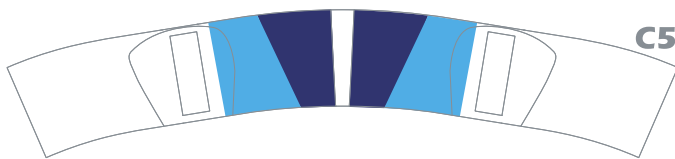
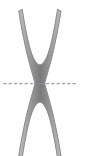
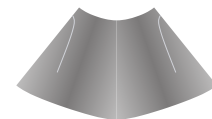
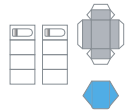

C6



C10L



C10R

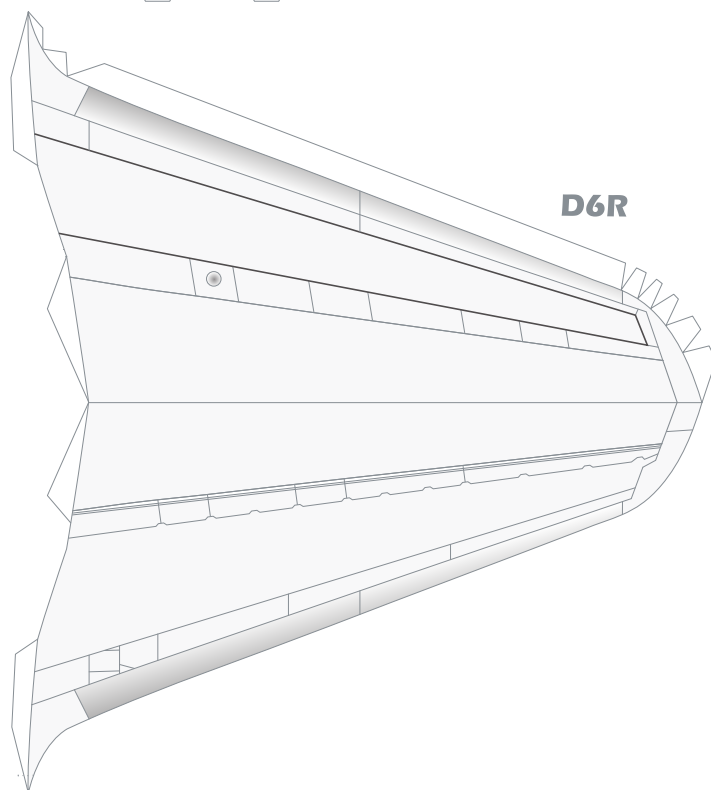
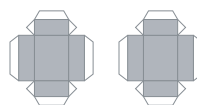
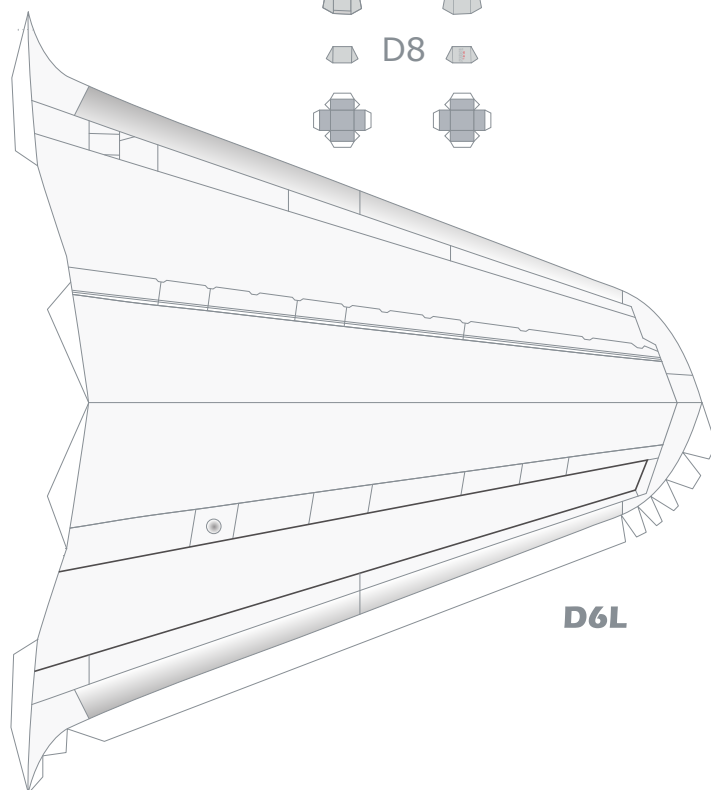
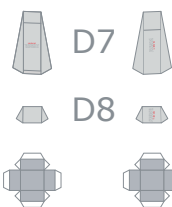
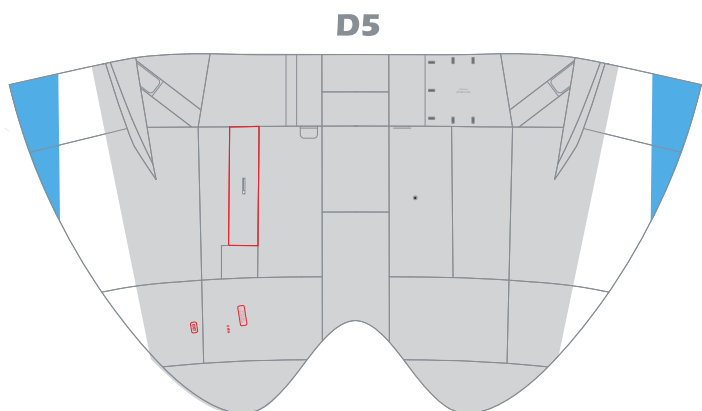
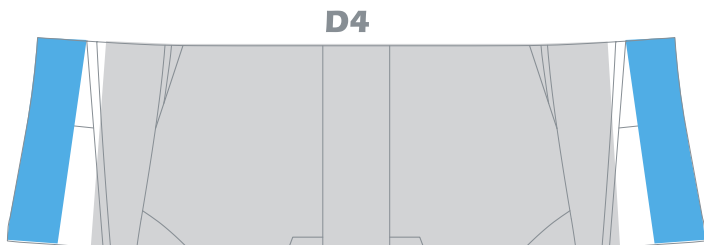
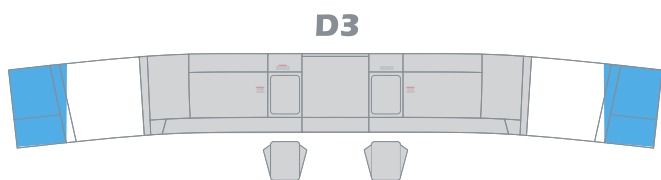
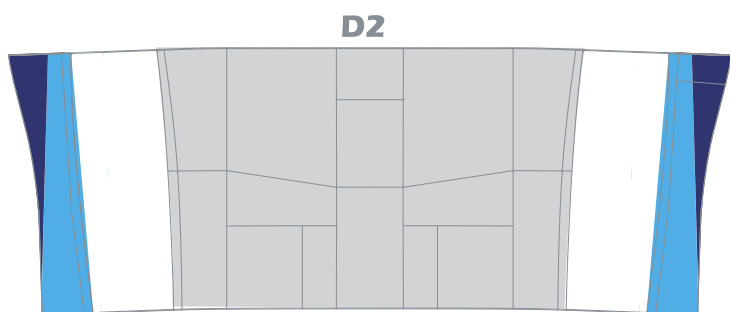
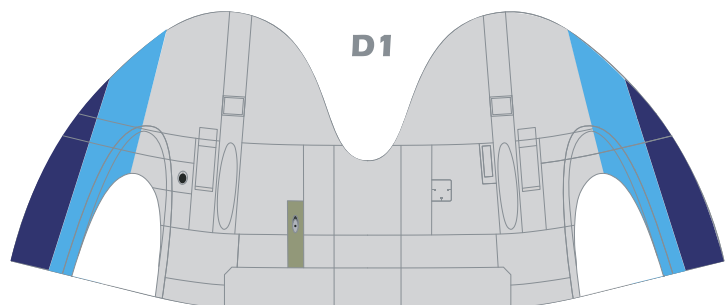

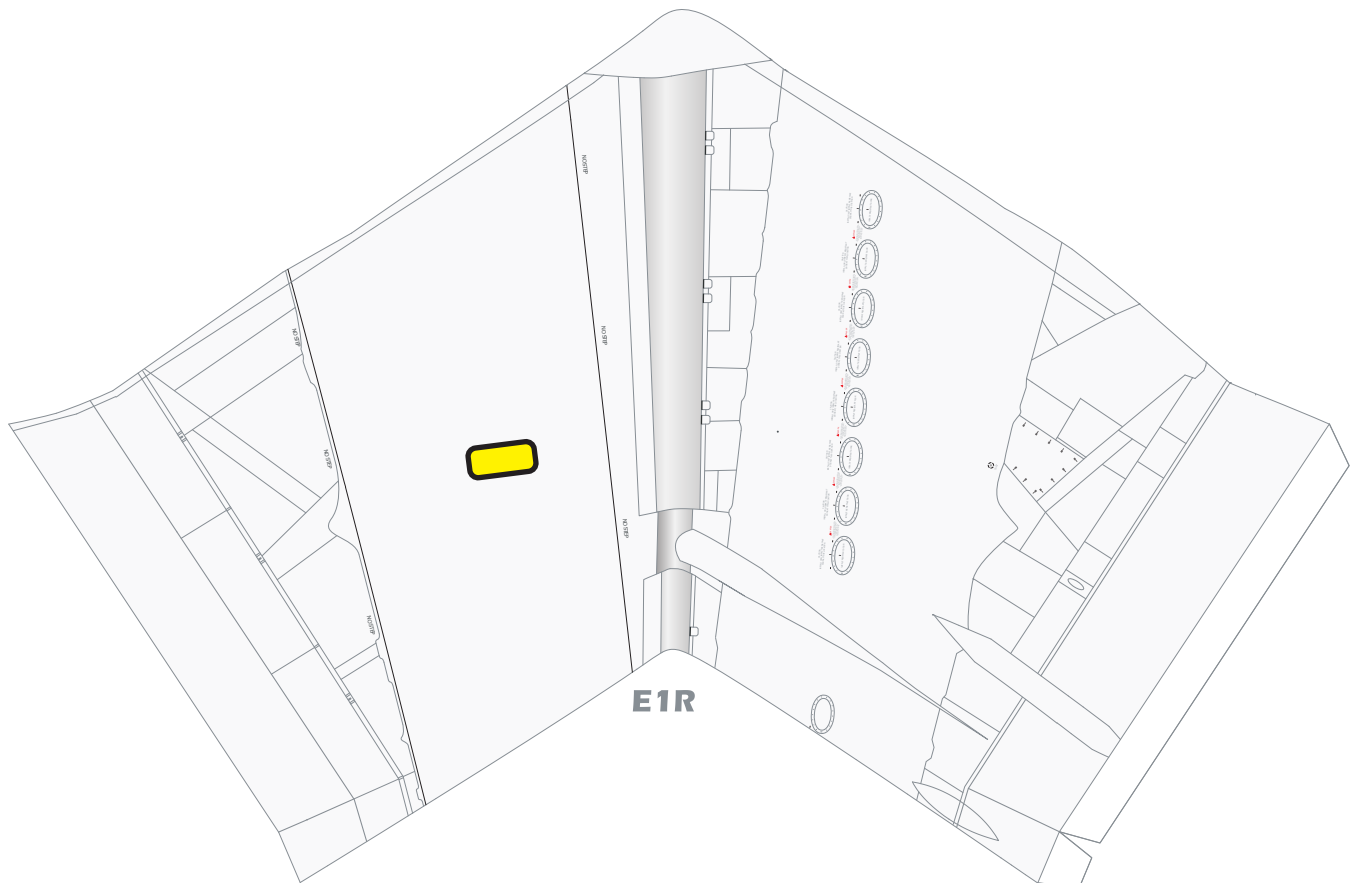
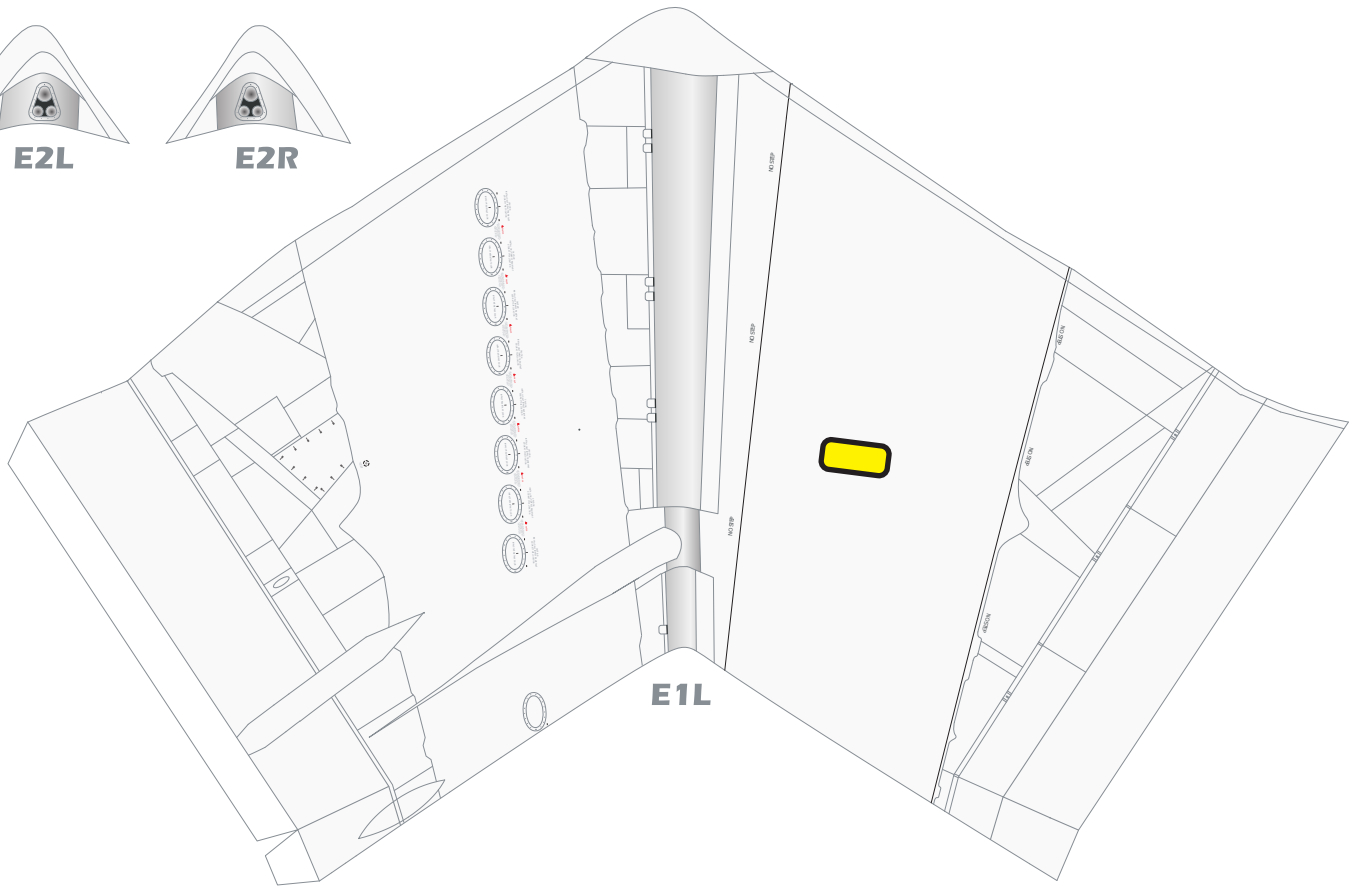

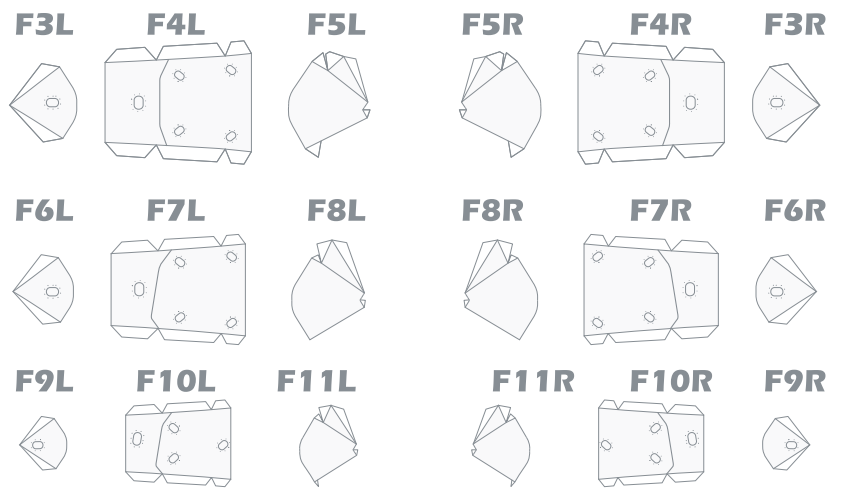
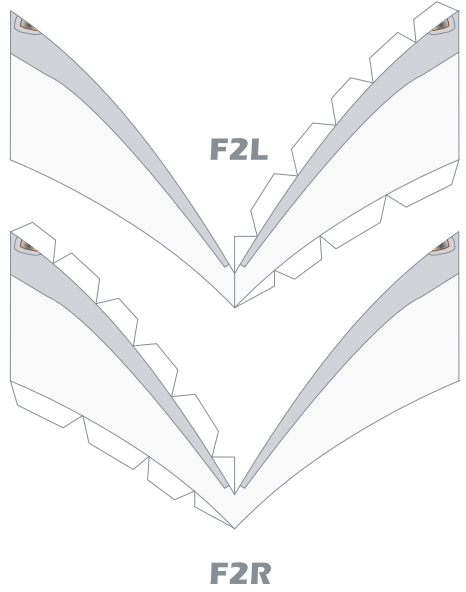
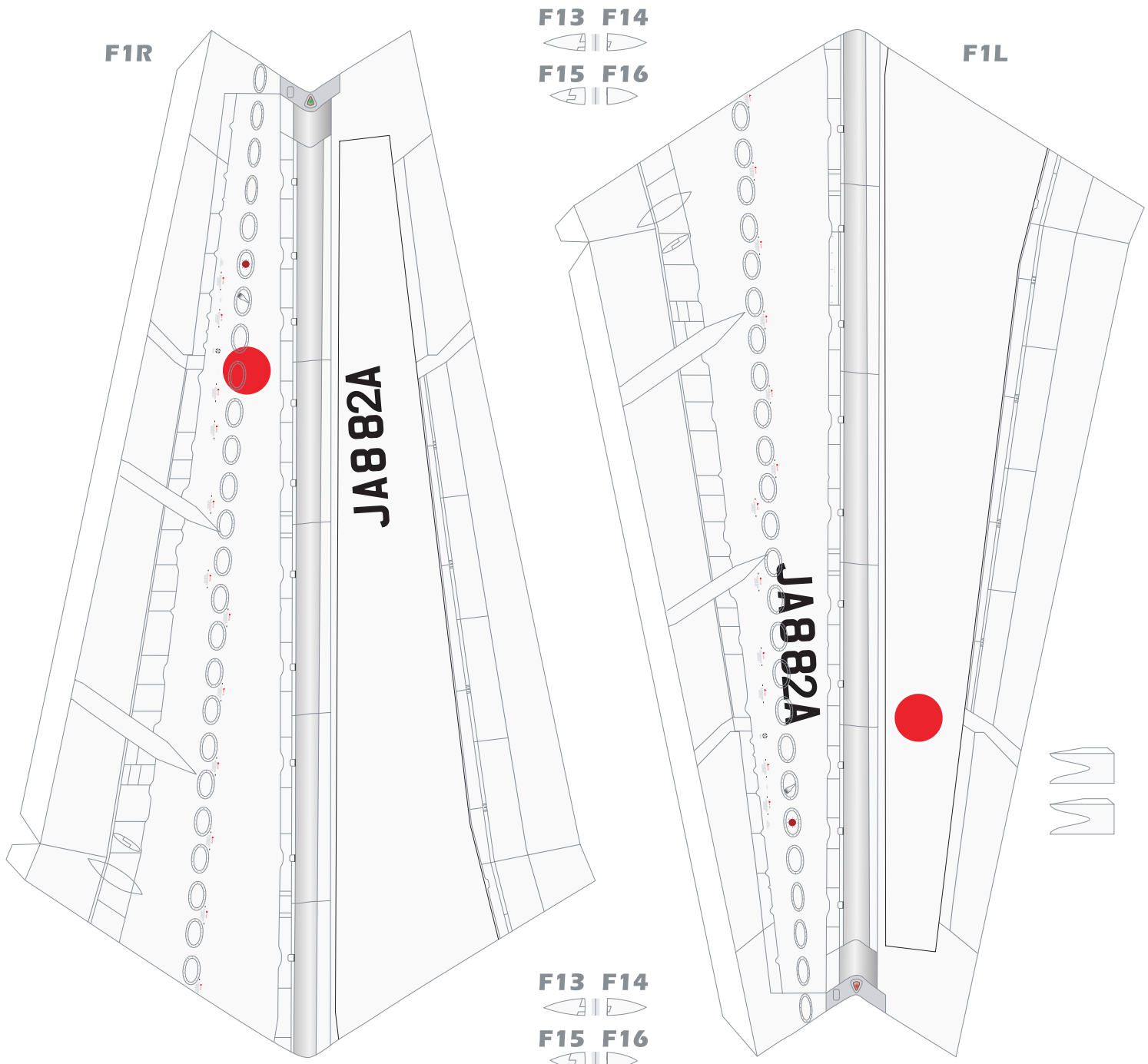

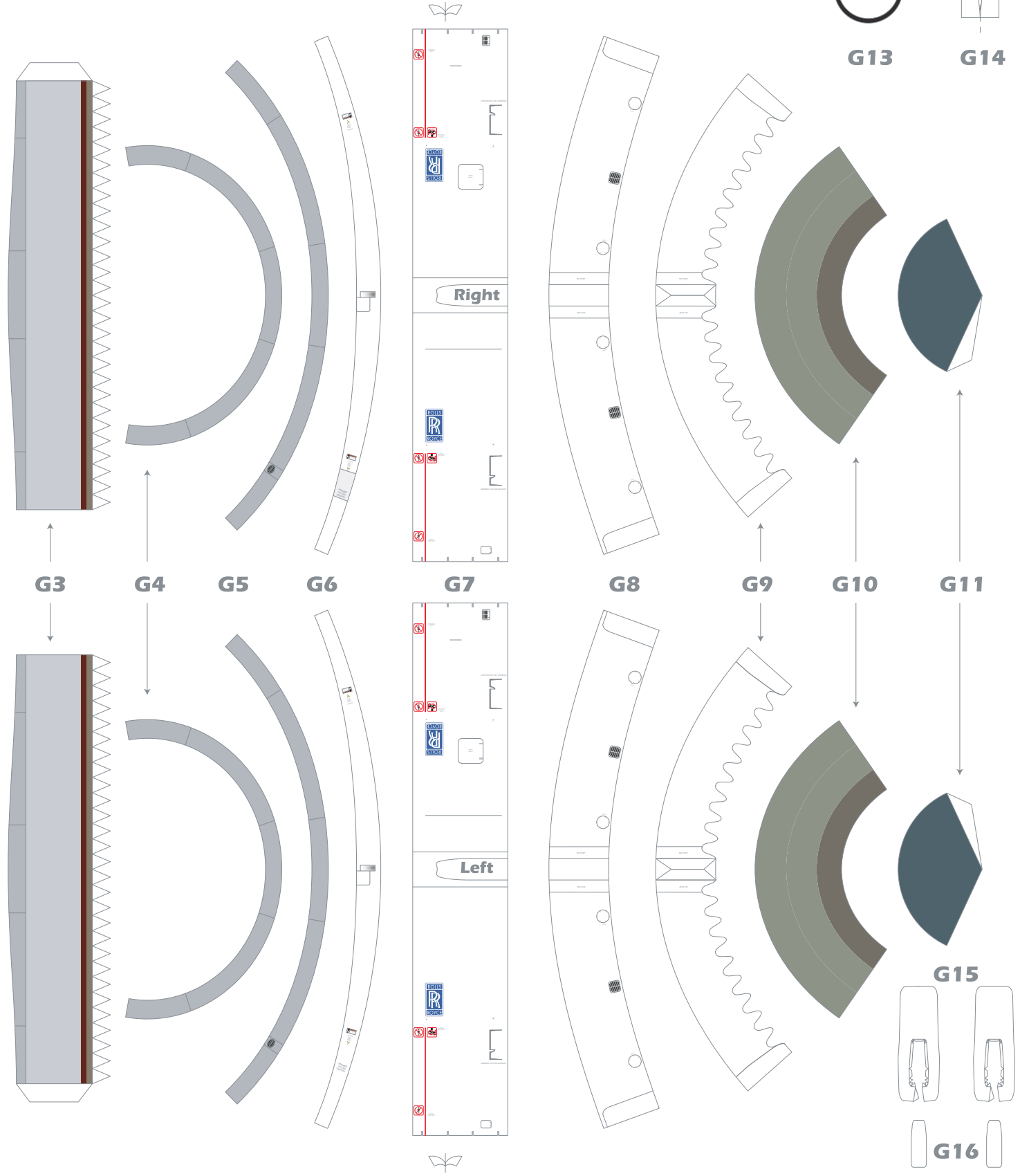
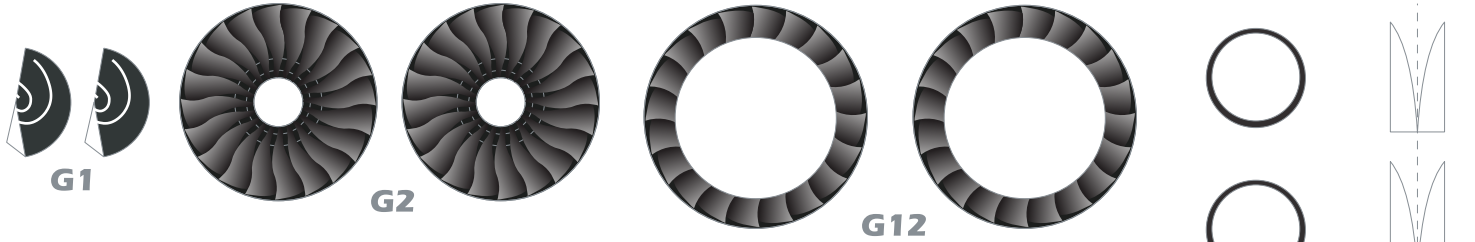

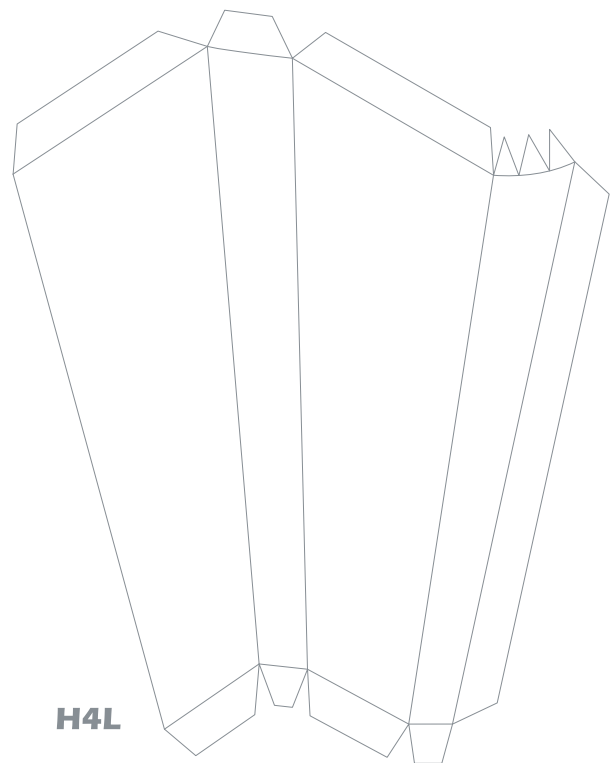
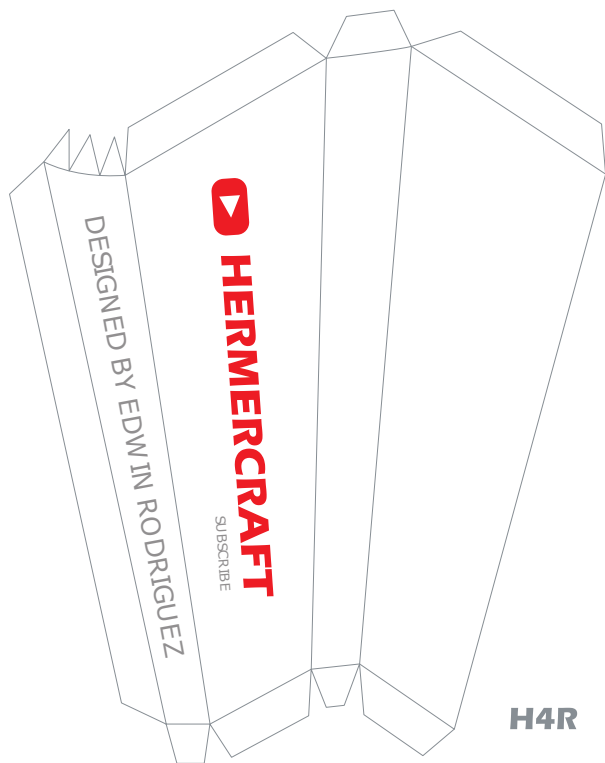
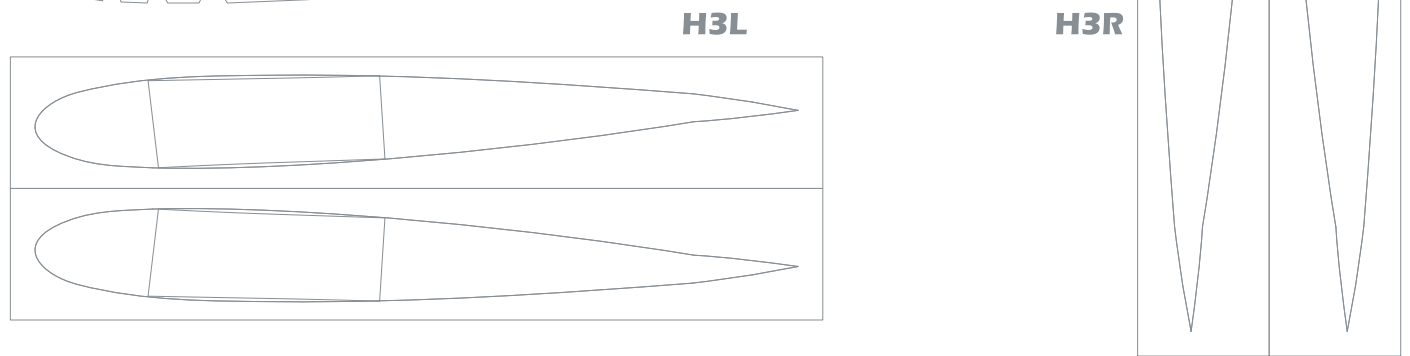
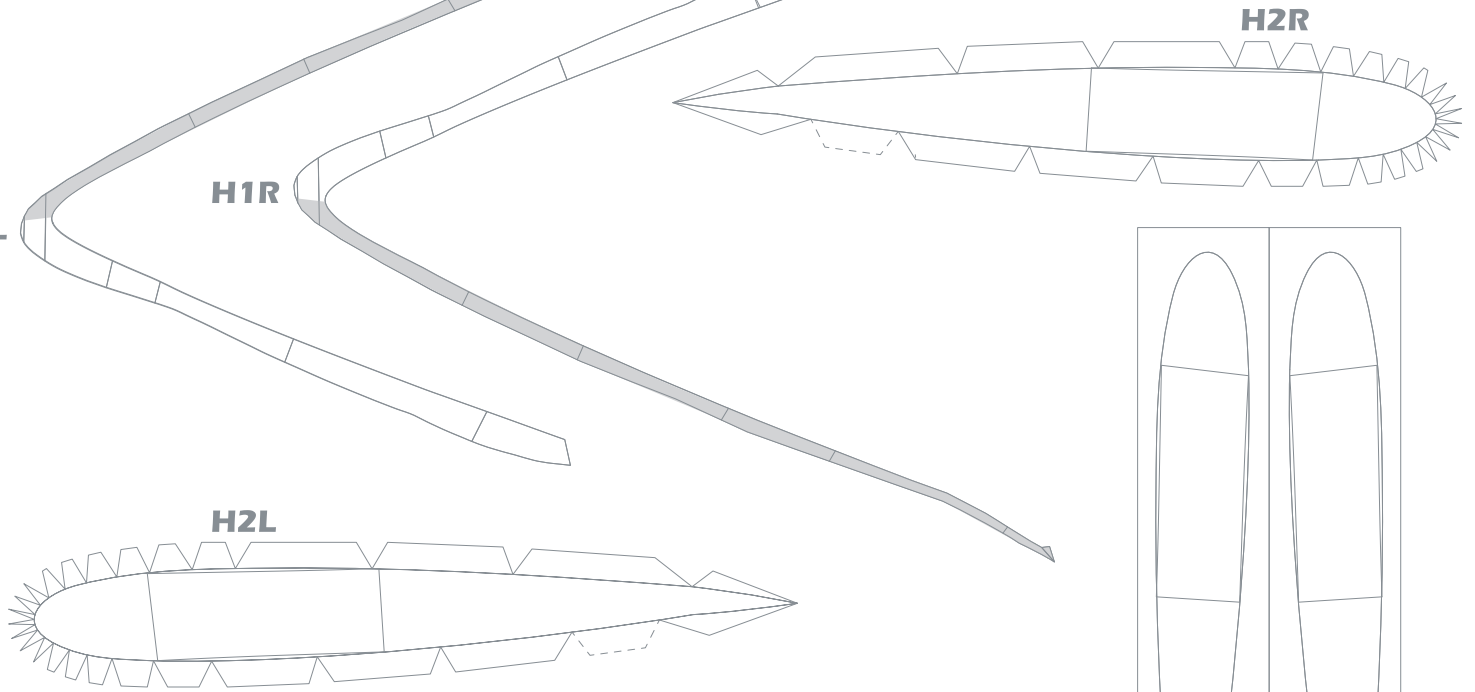
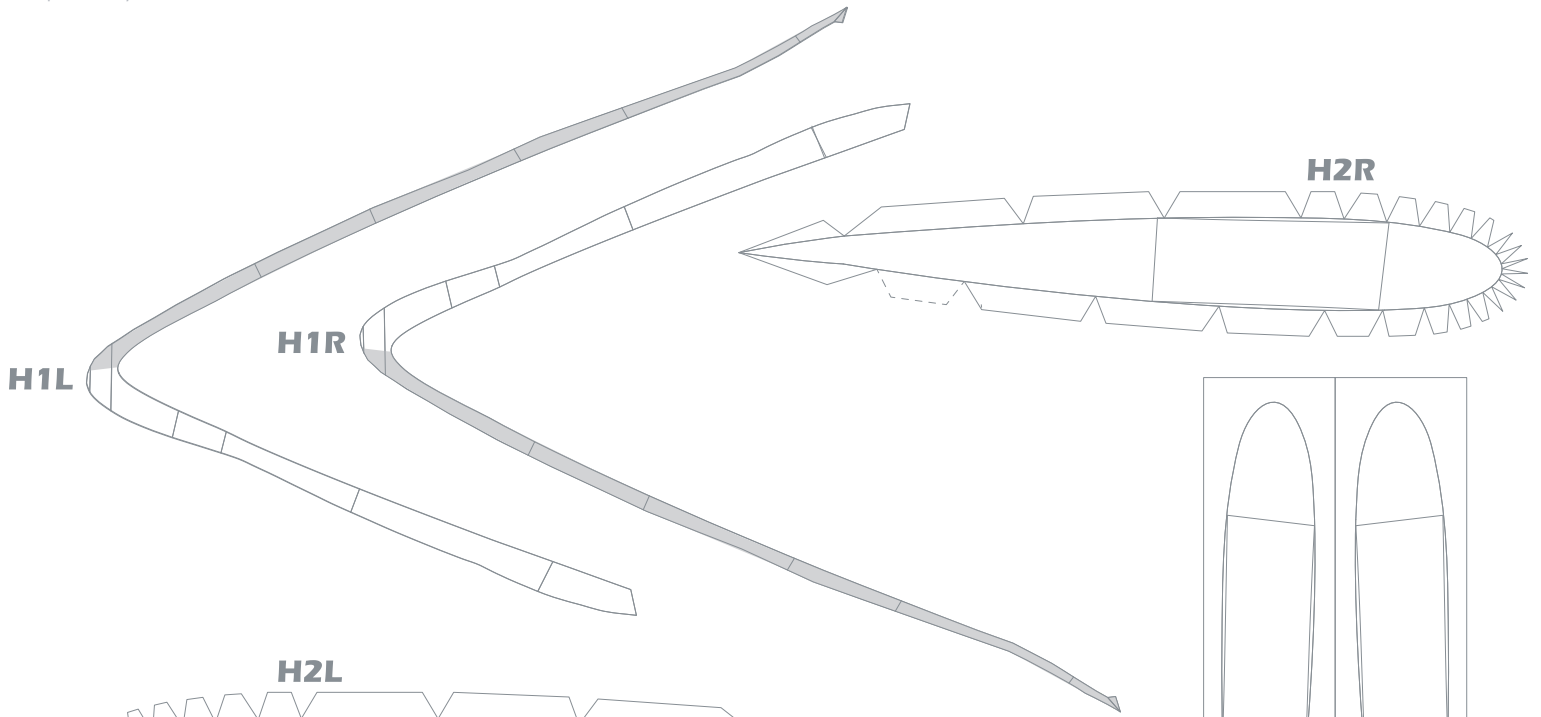



Repainted by: Jan Gabriel Jimenez and Joshua Takahashi

©2021 Edwin Rodriguez

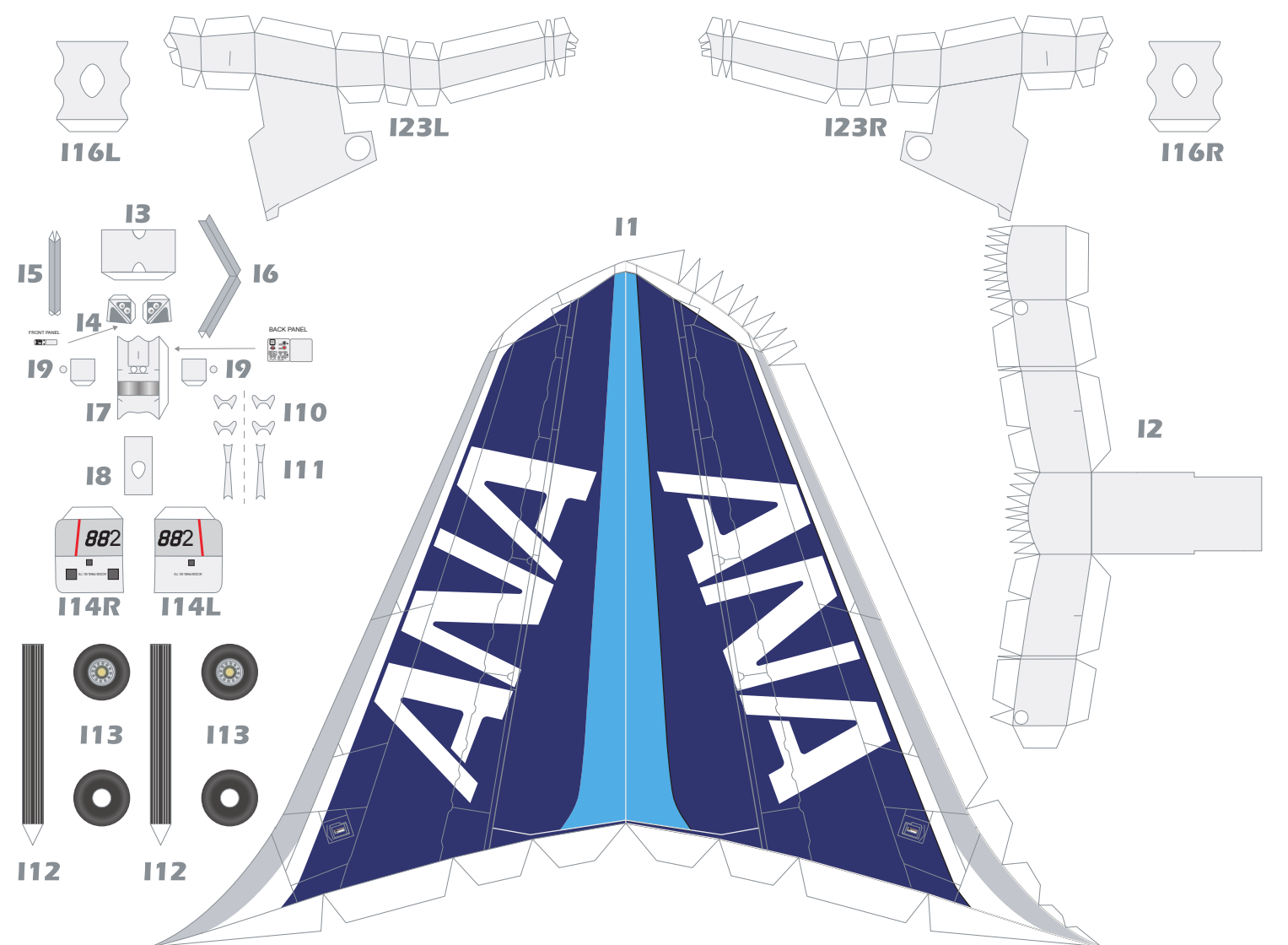
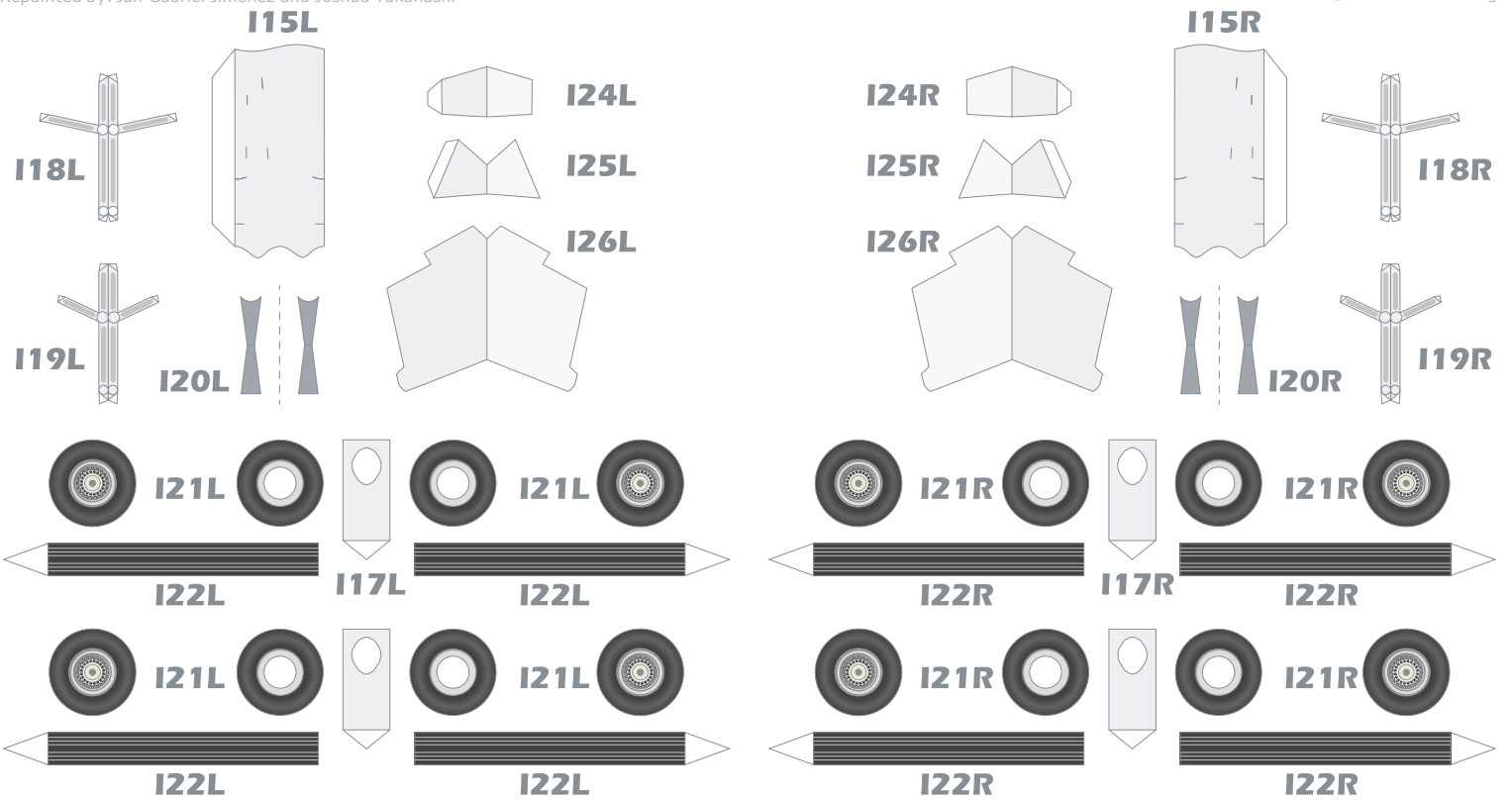

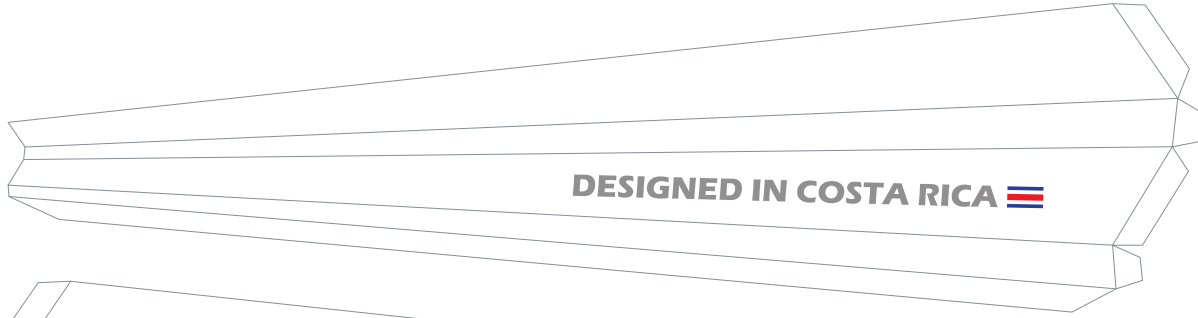

J1L



J1R

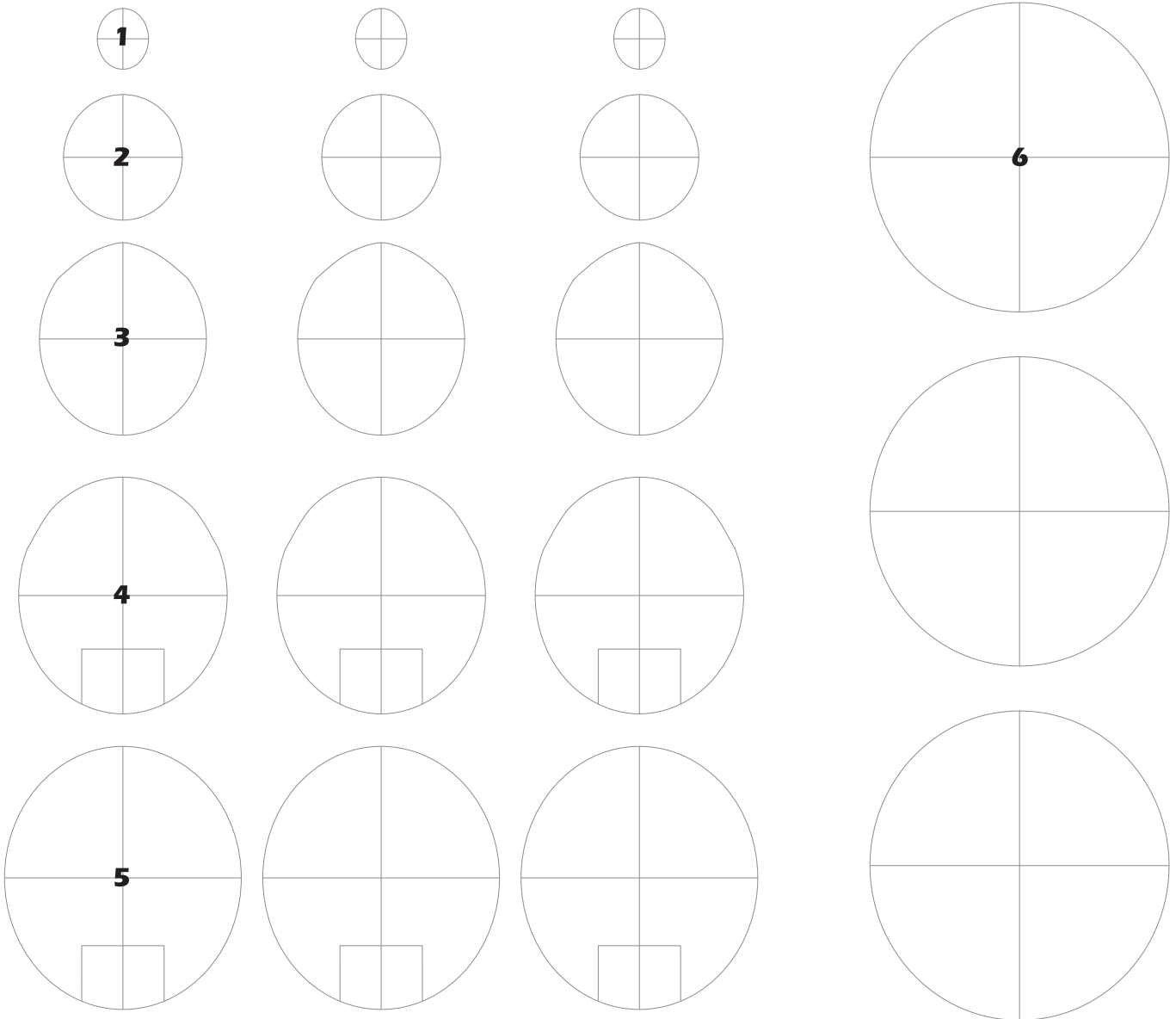

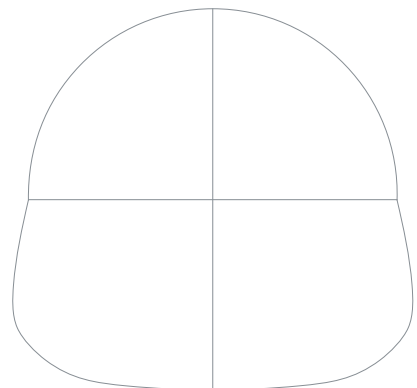
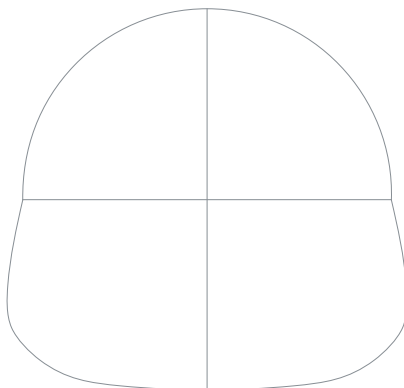
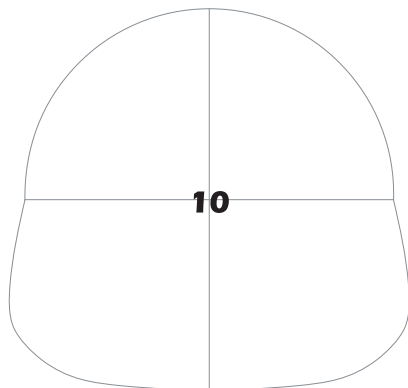
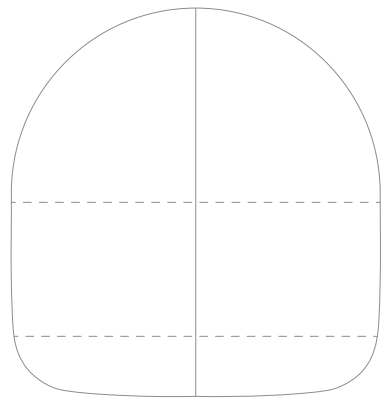
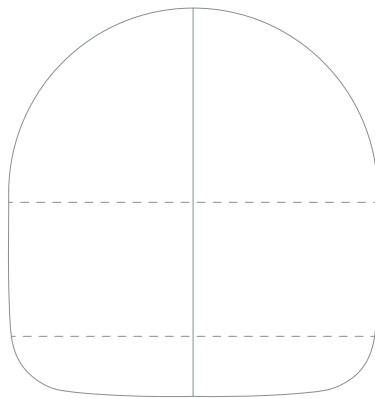
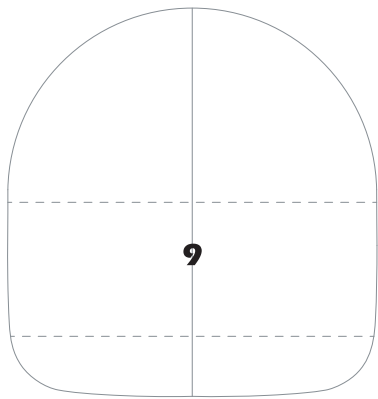
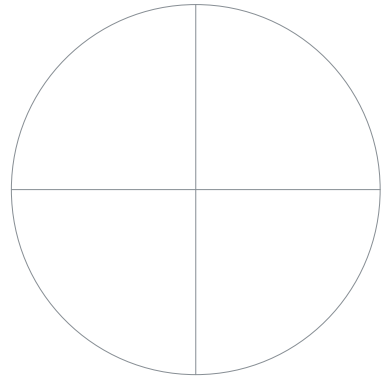
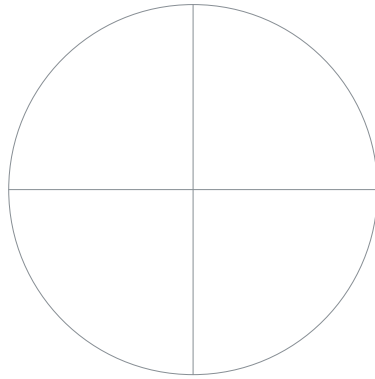
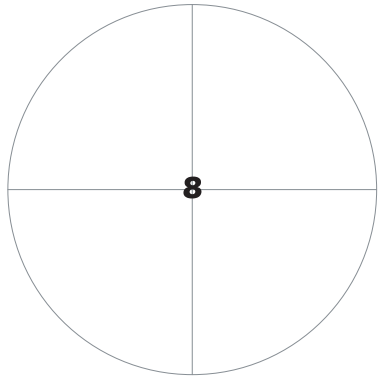
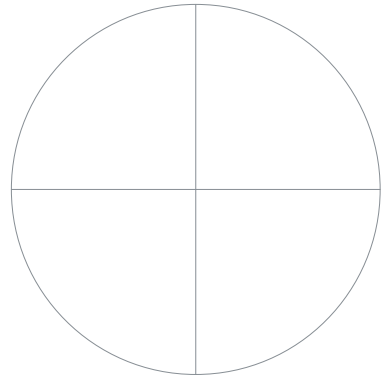
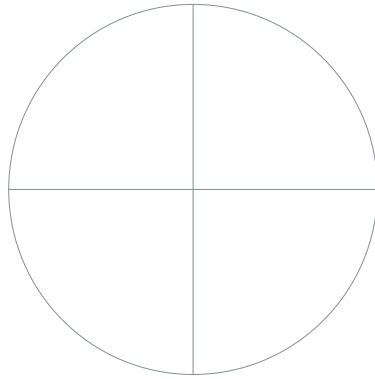
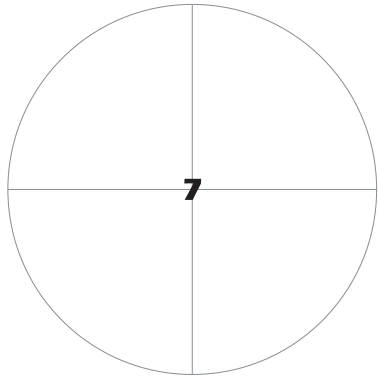

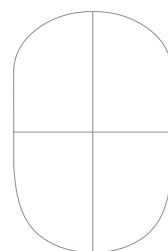
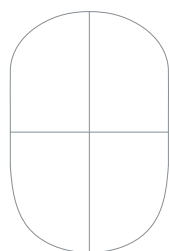
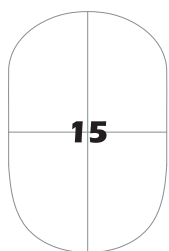
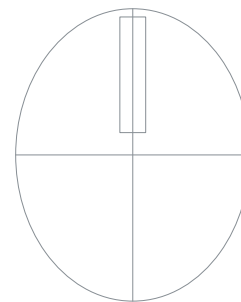
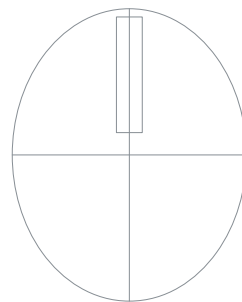
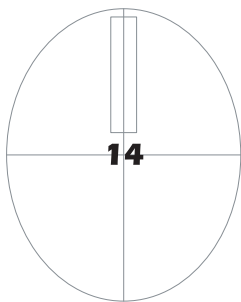
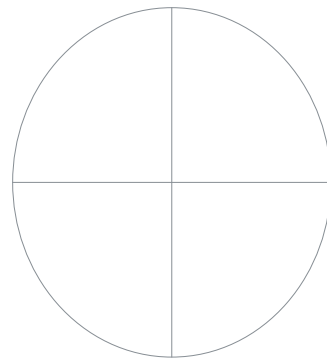
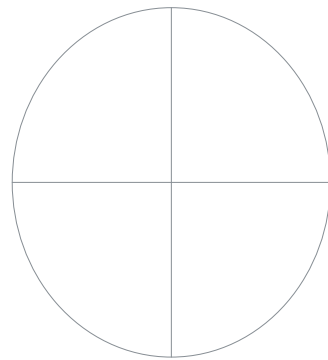
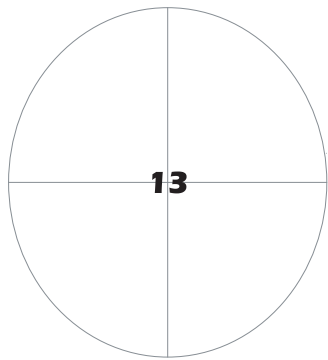
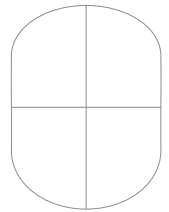
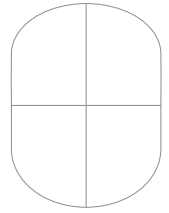
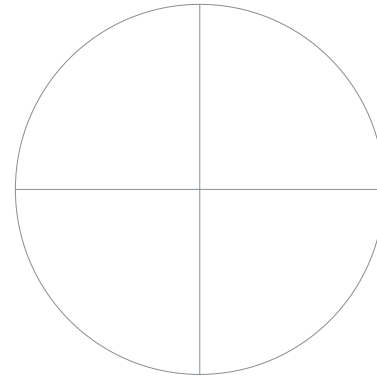
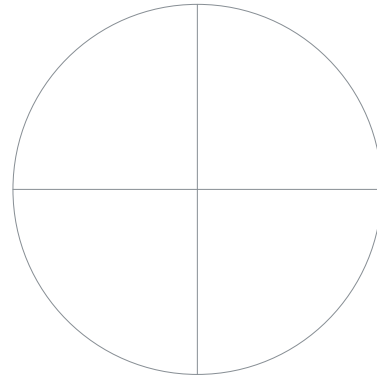
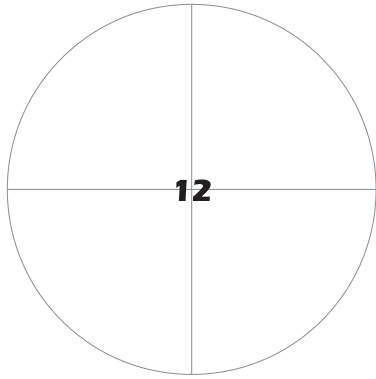
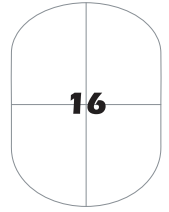
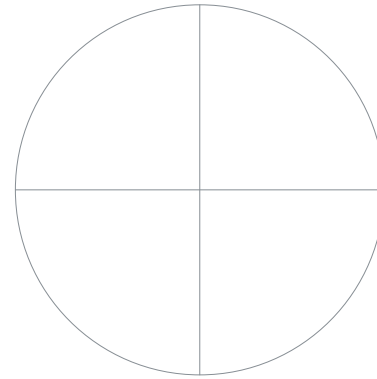
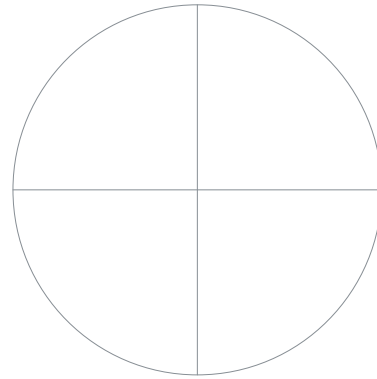
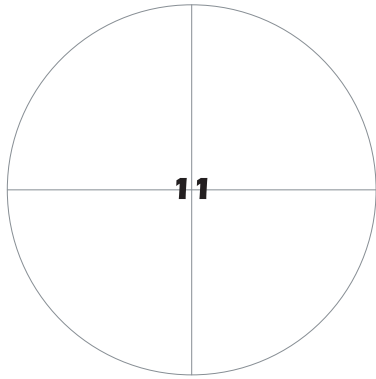

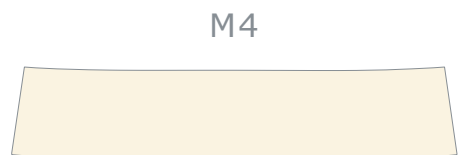
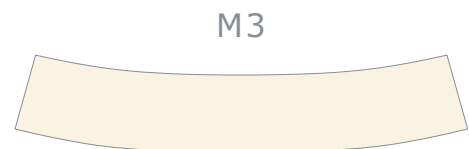

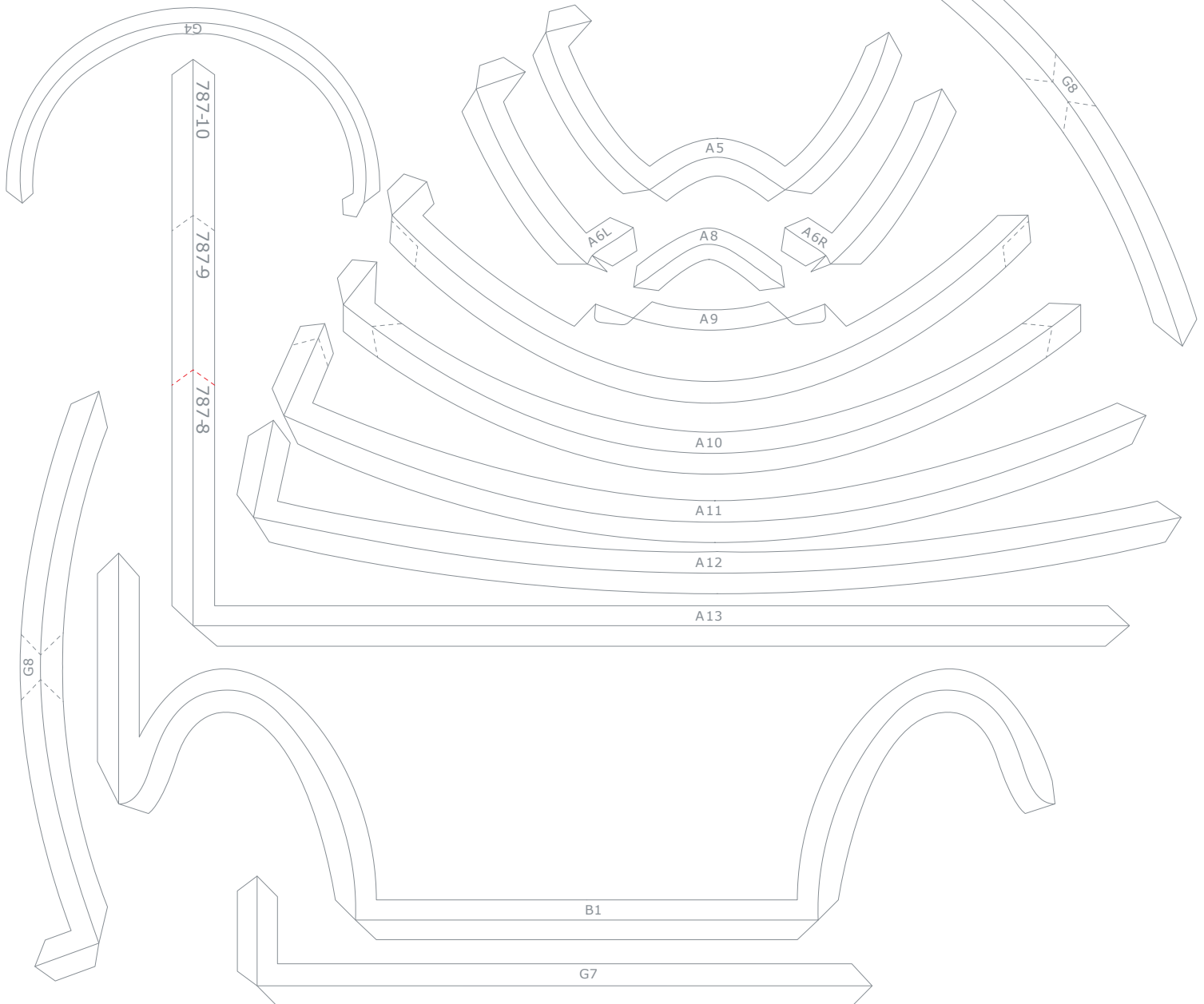
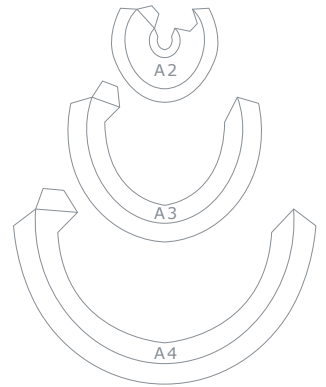
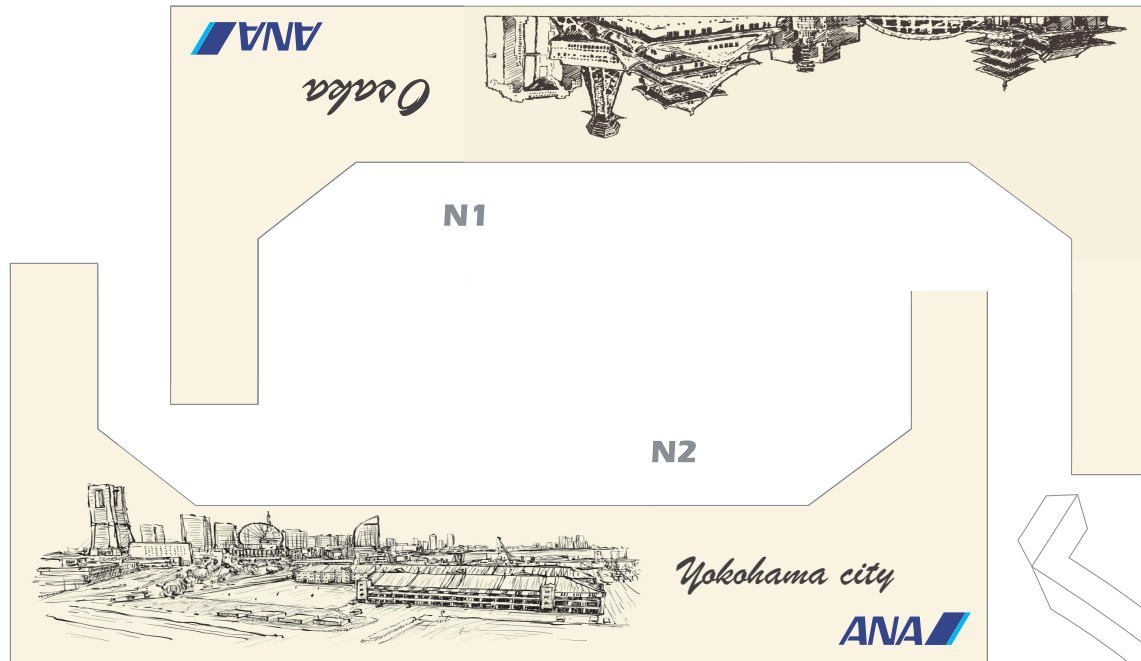

# BOEING 787-9 ALL NIPPON AIRWAYS 50TH 787 LIVERY

Repainted by: Jan Gabriel Jimenez and Joshua Takahashi

©2021 Edwin Rodríguez

