

- B5* 
- B7* 
- B9* 
- B6* 
- B8* 
- B10* 

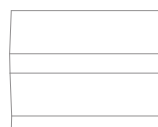

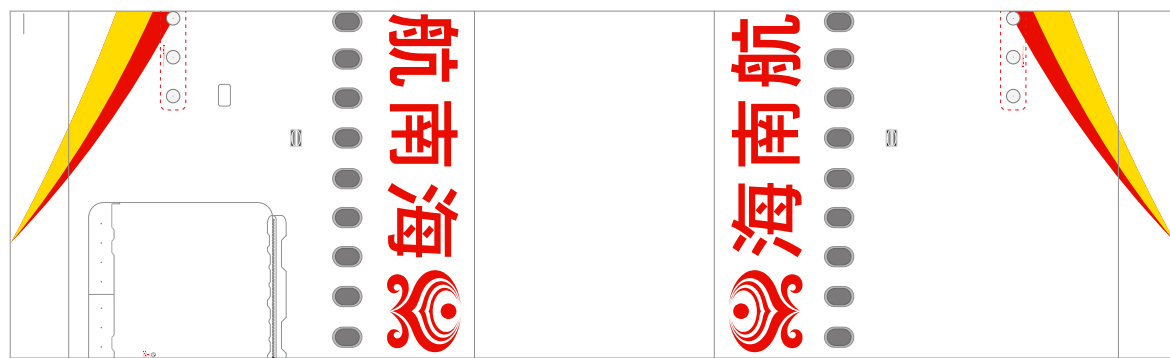

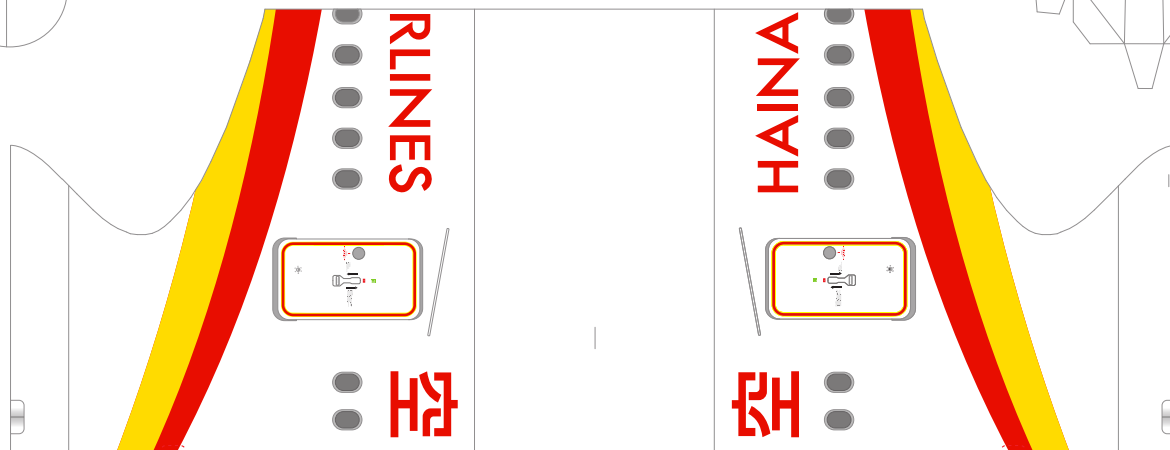

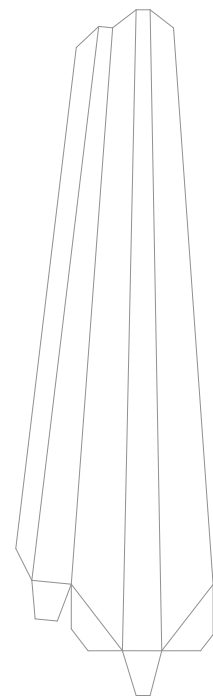
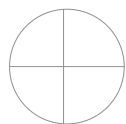
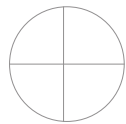
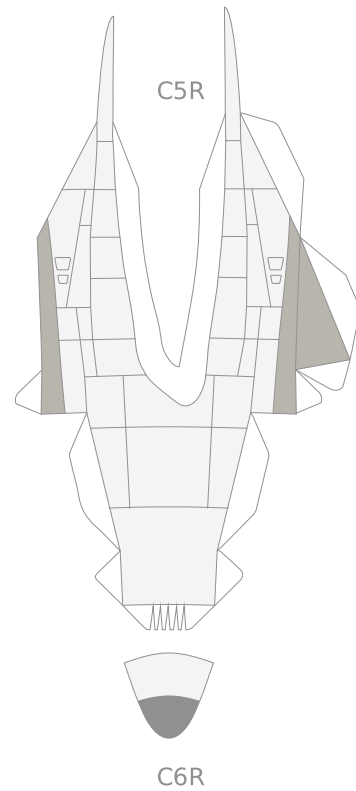
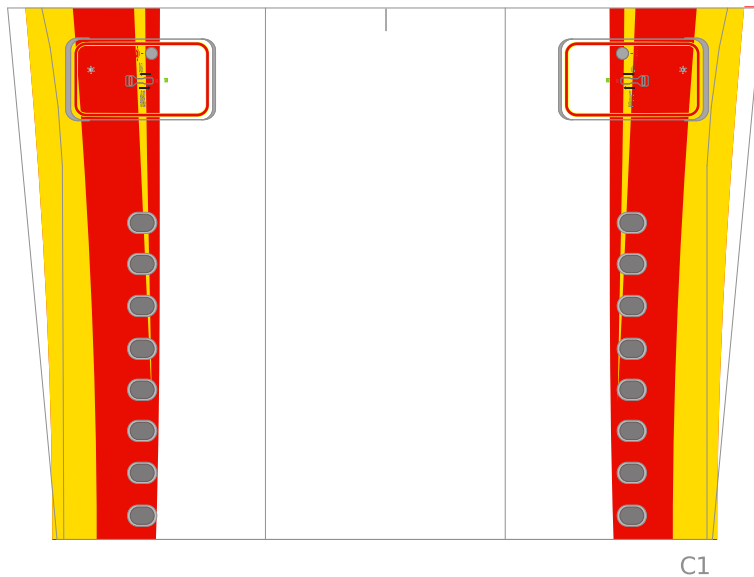
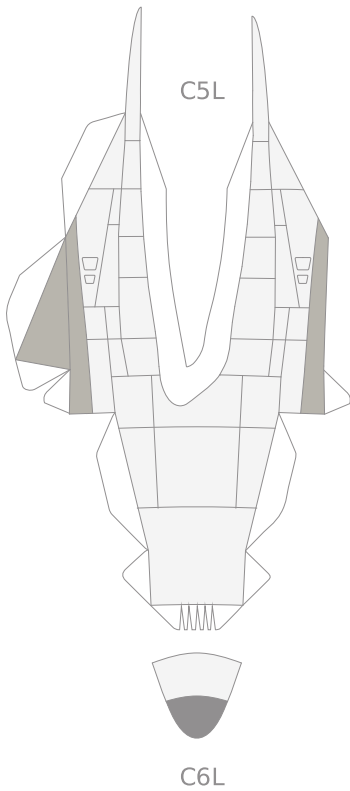
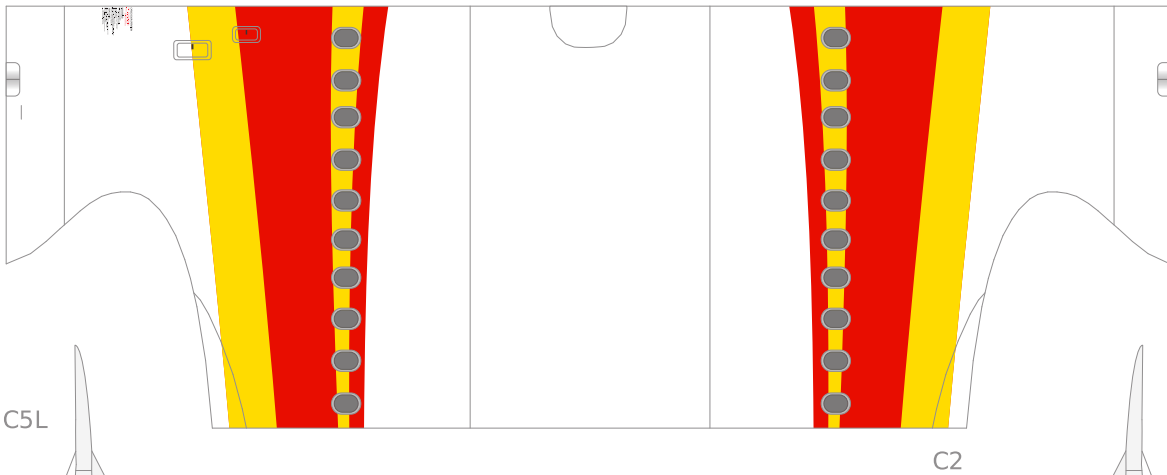
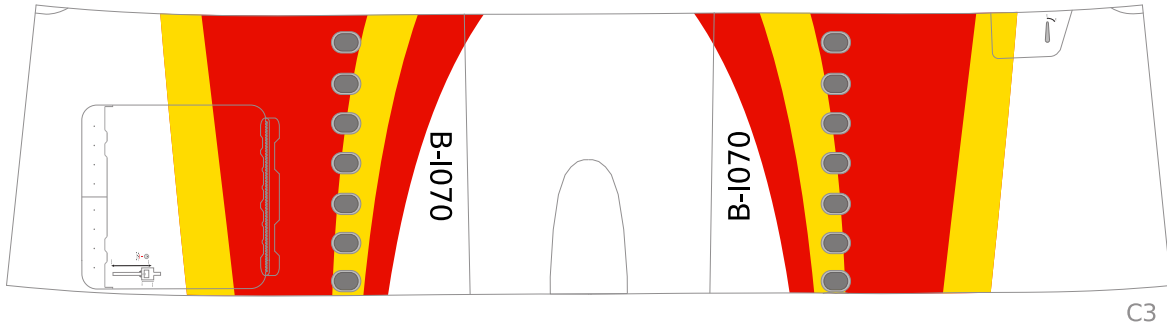
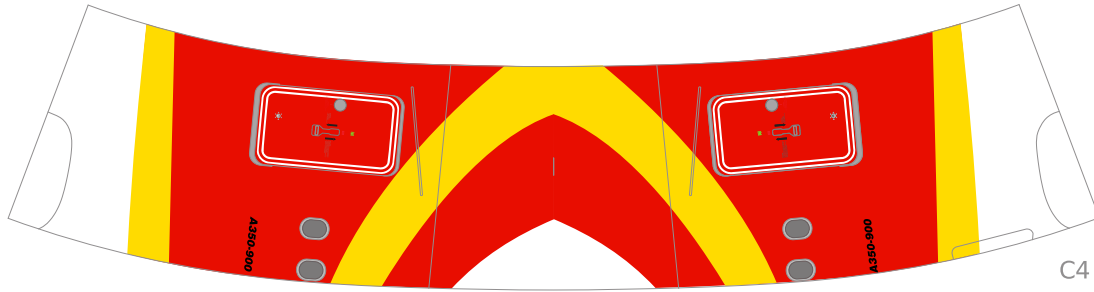
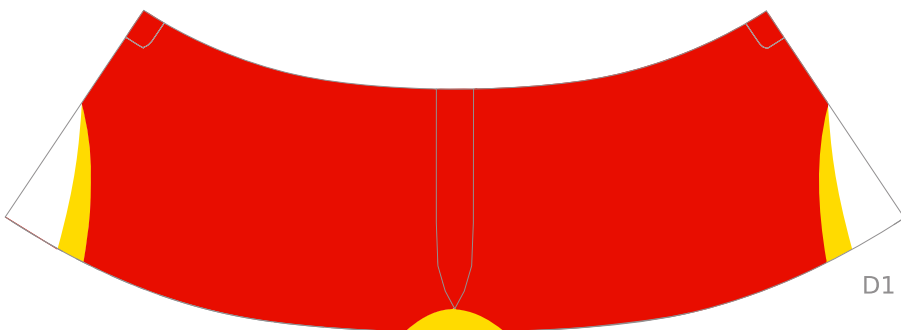
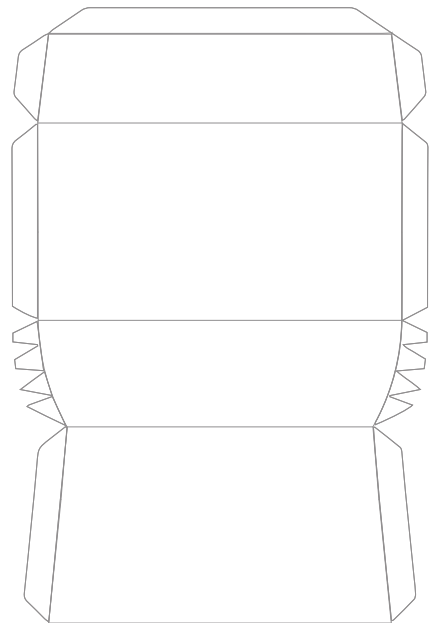
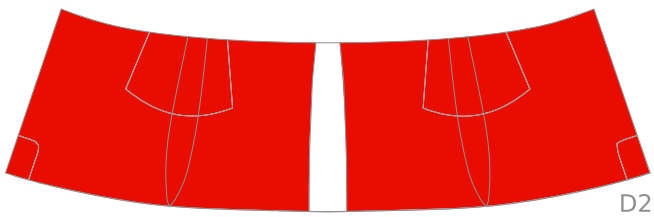
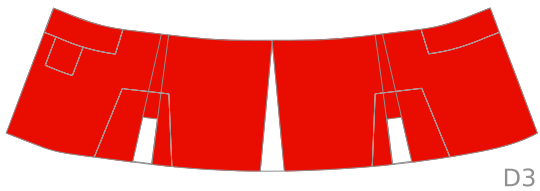
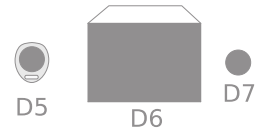
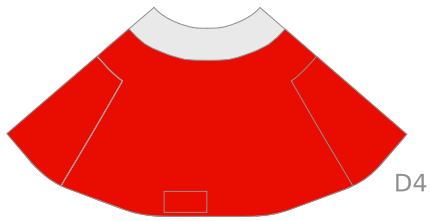
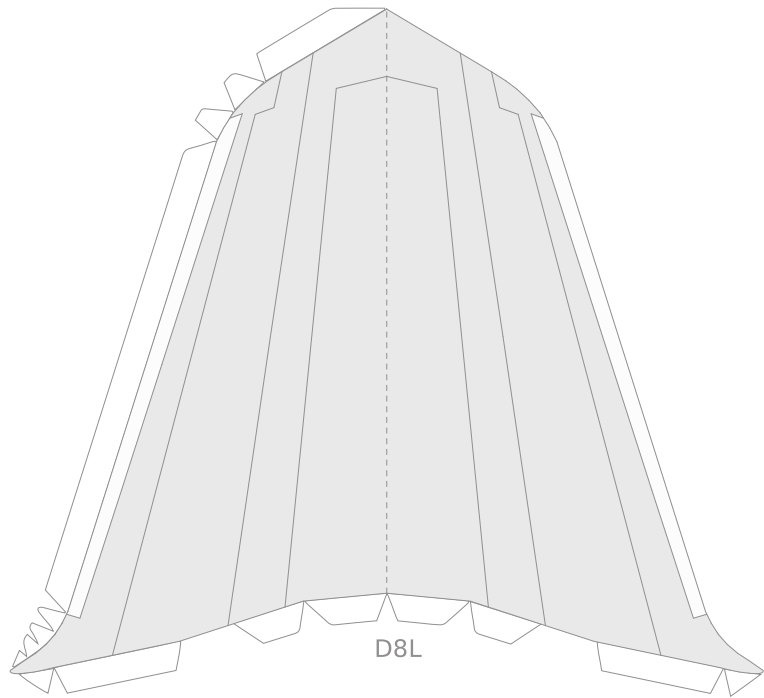
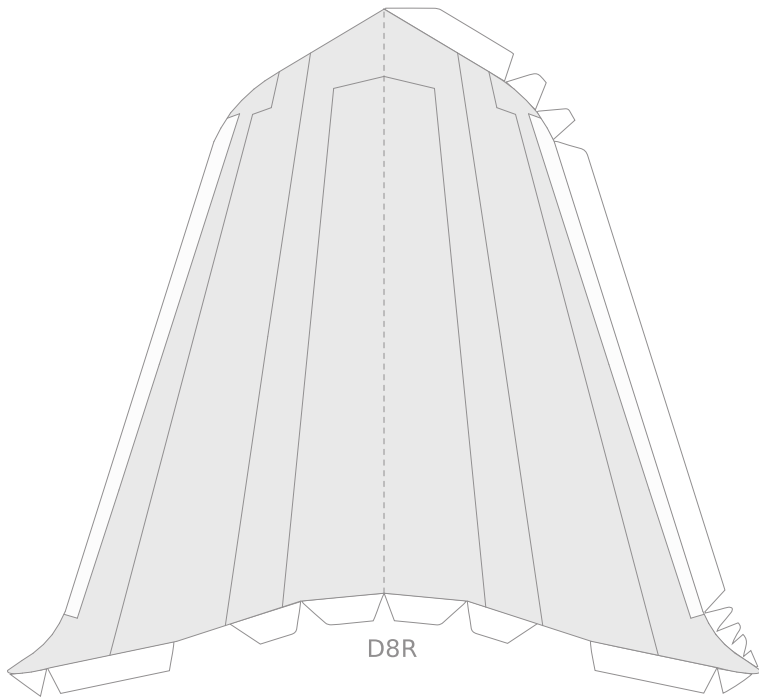
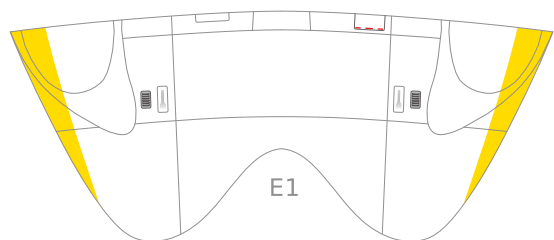
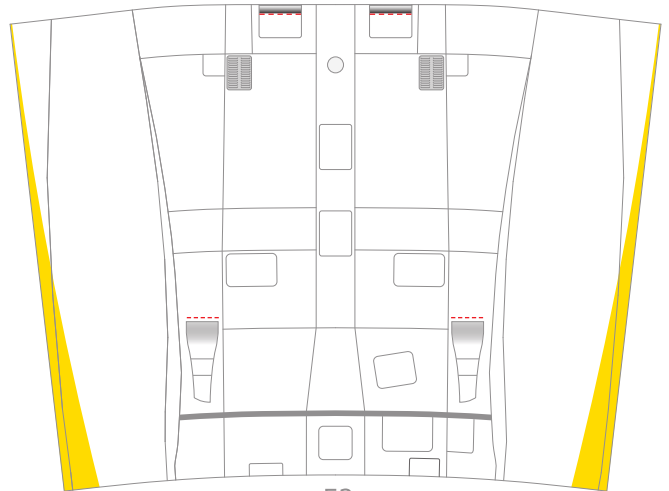
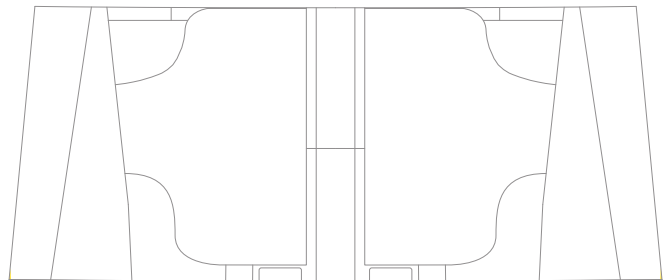
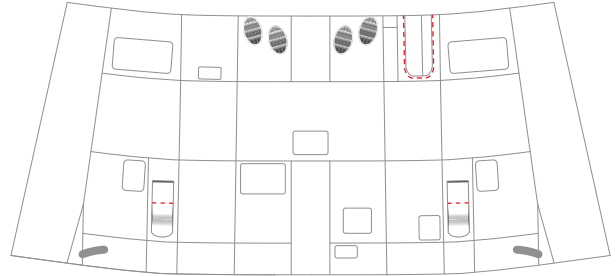
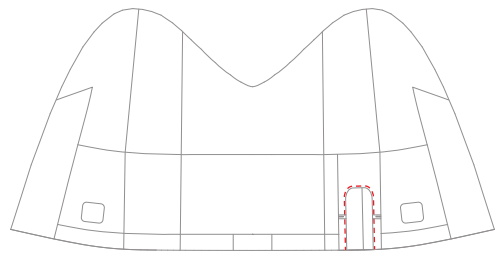
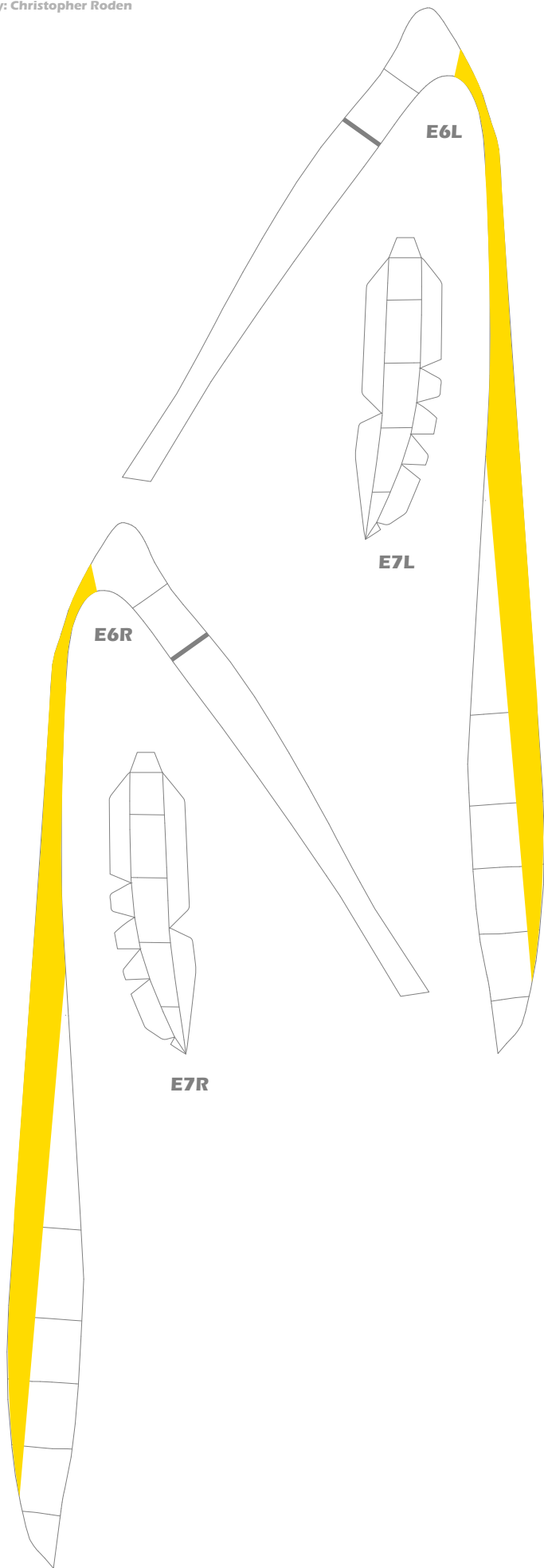

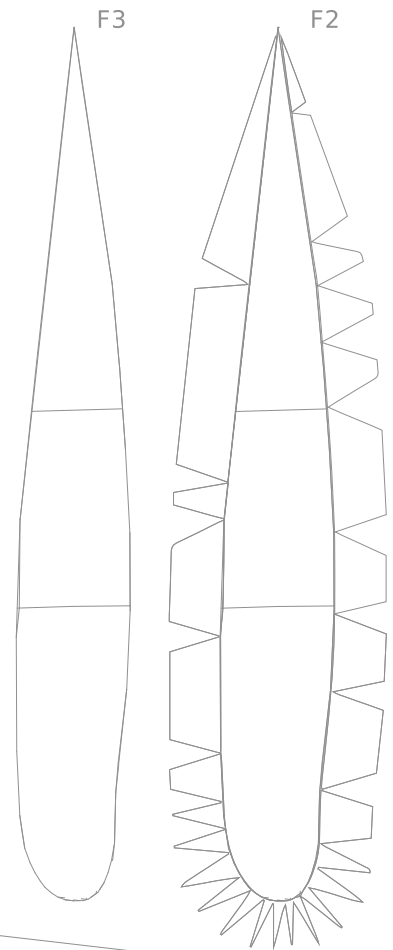
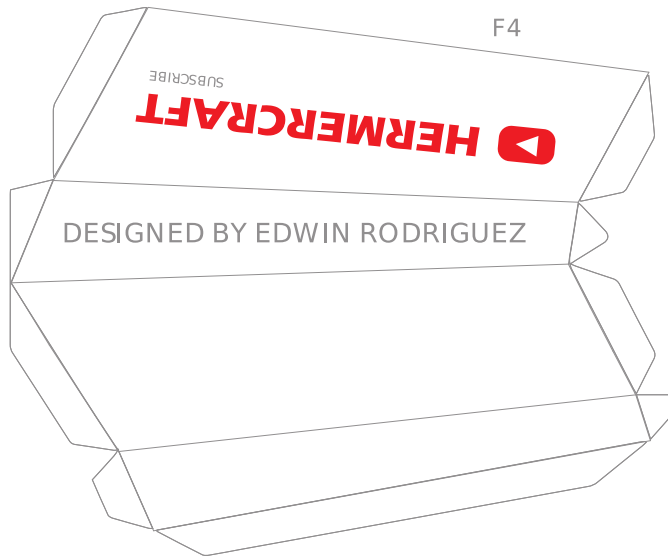
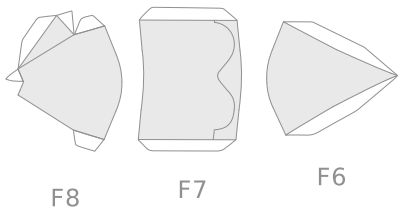
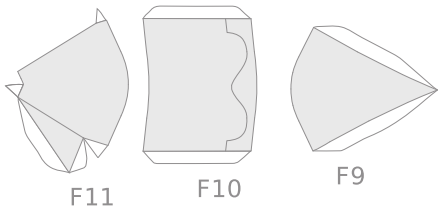
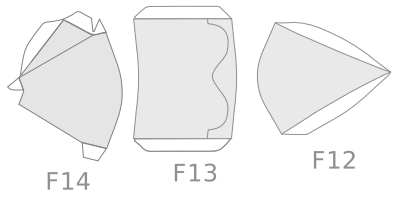
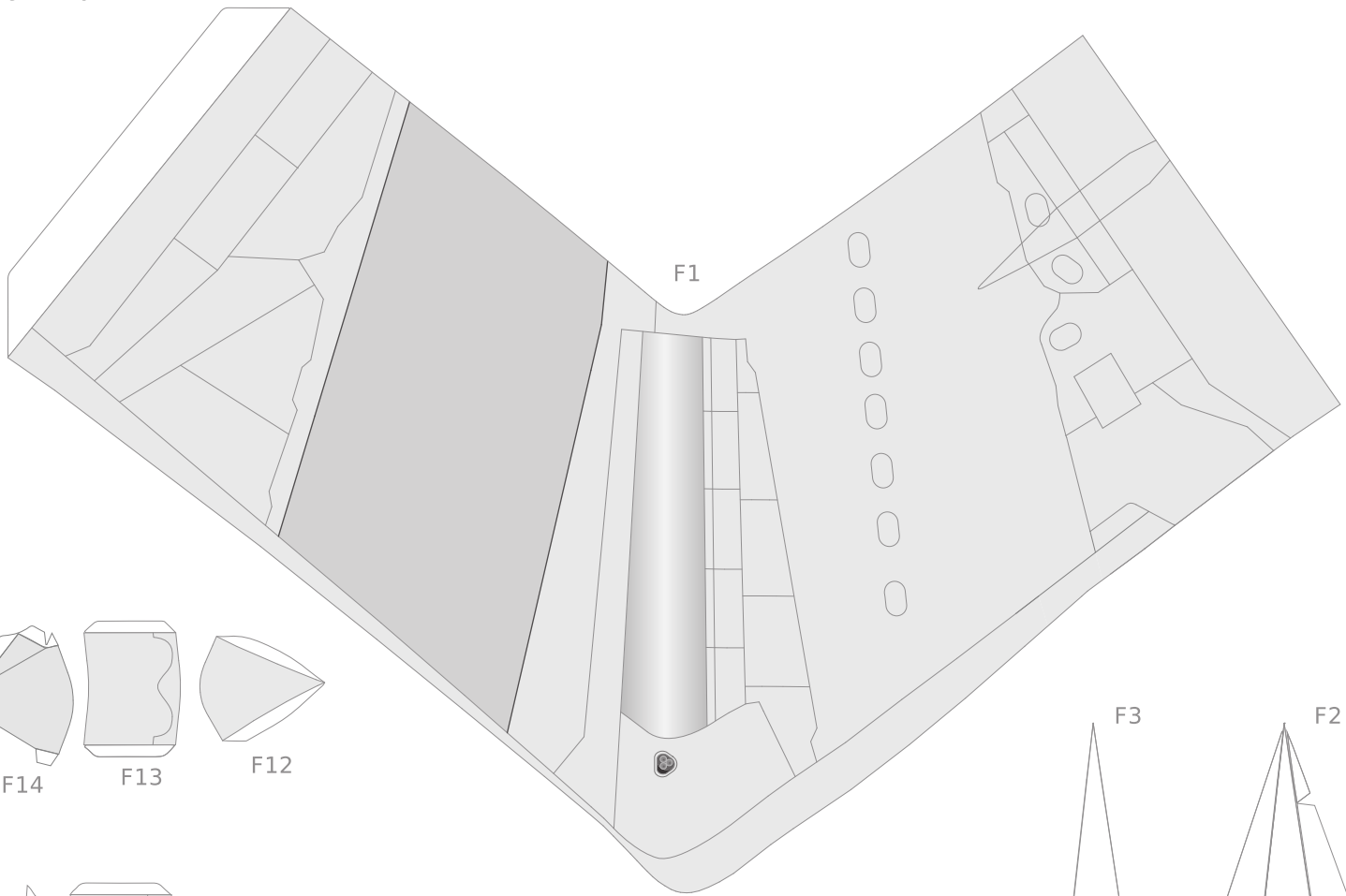

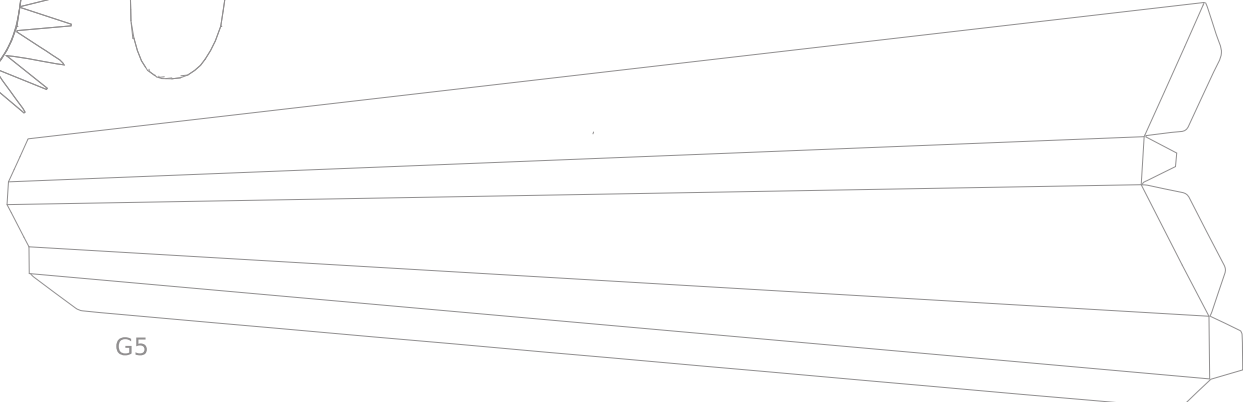
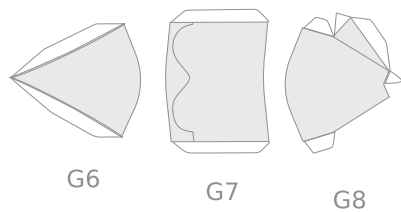
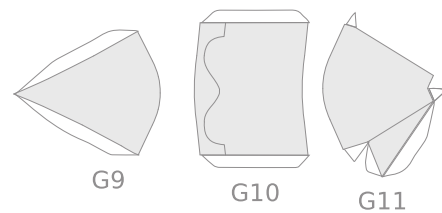
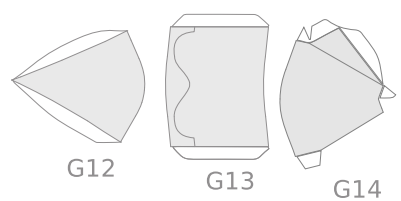
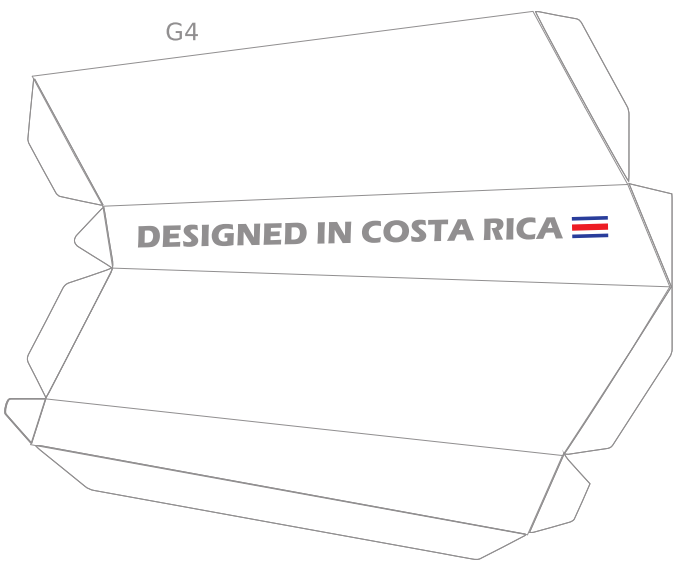
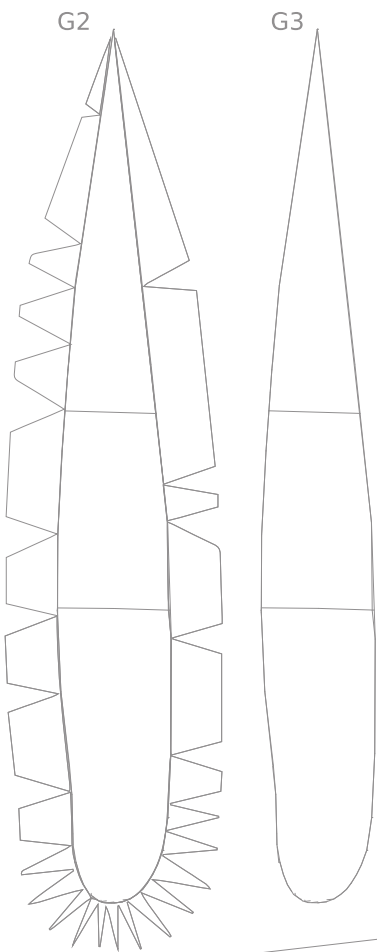
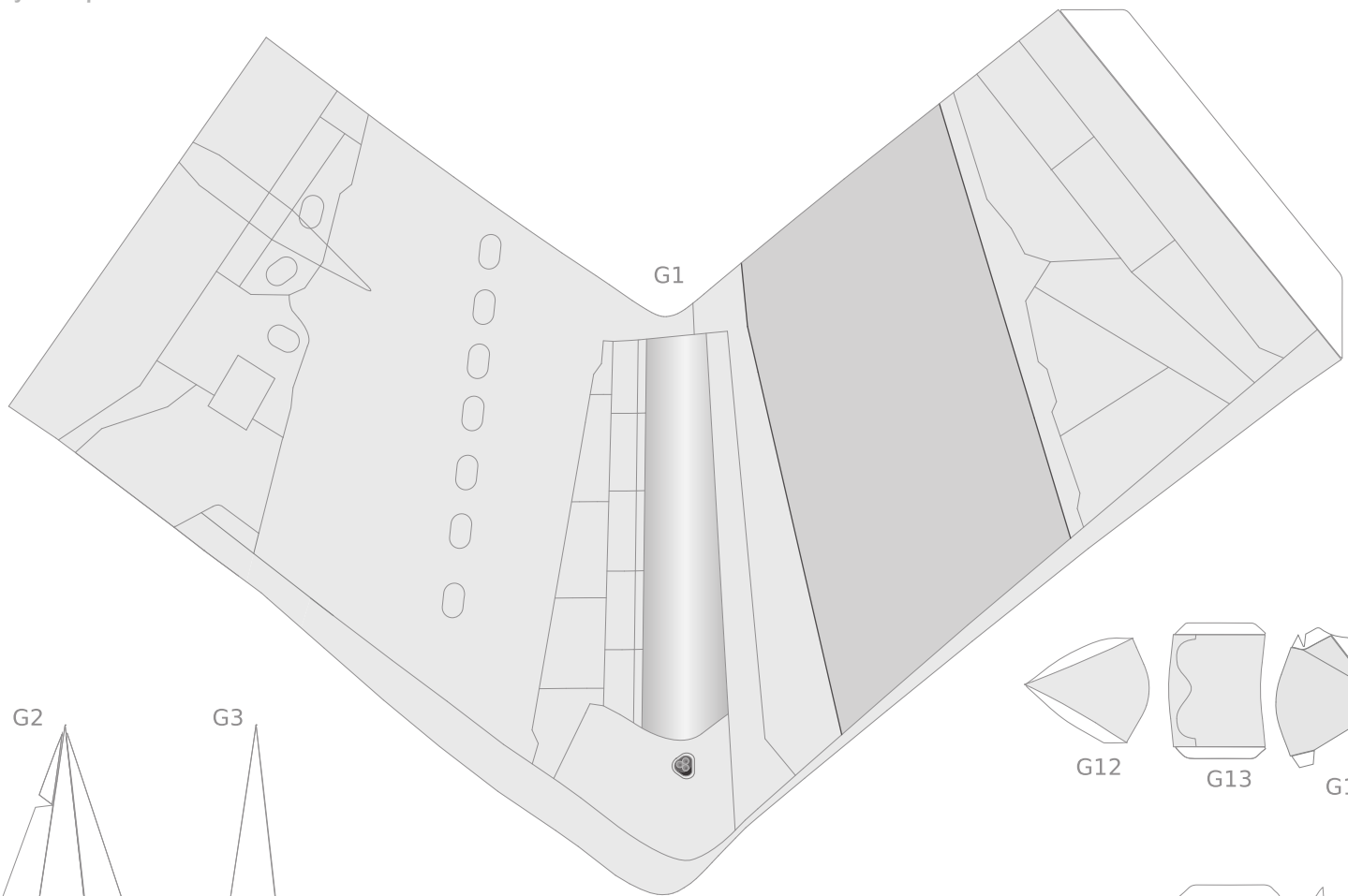

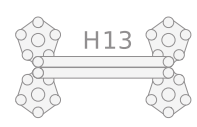
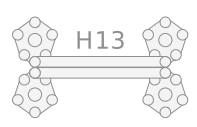
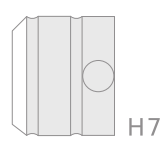
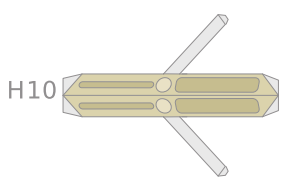
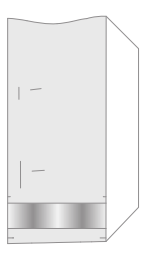
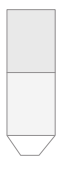
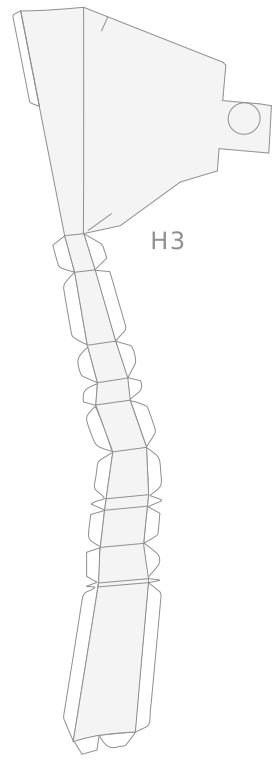
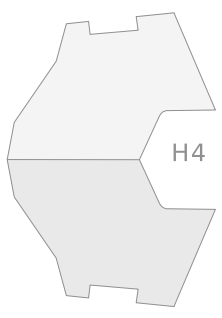
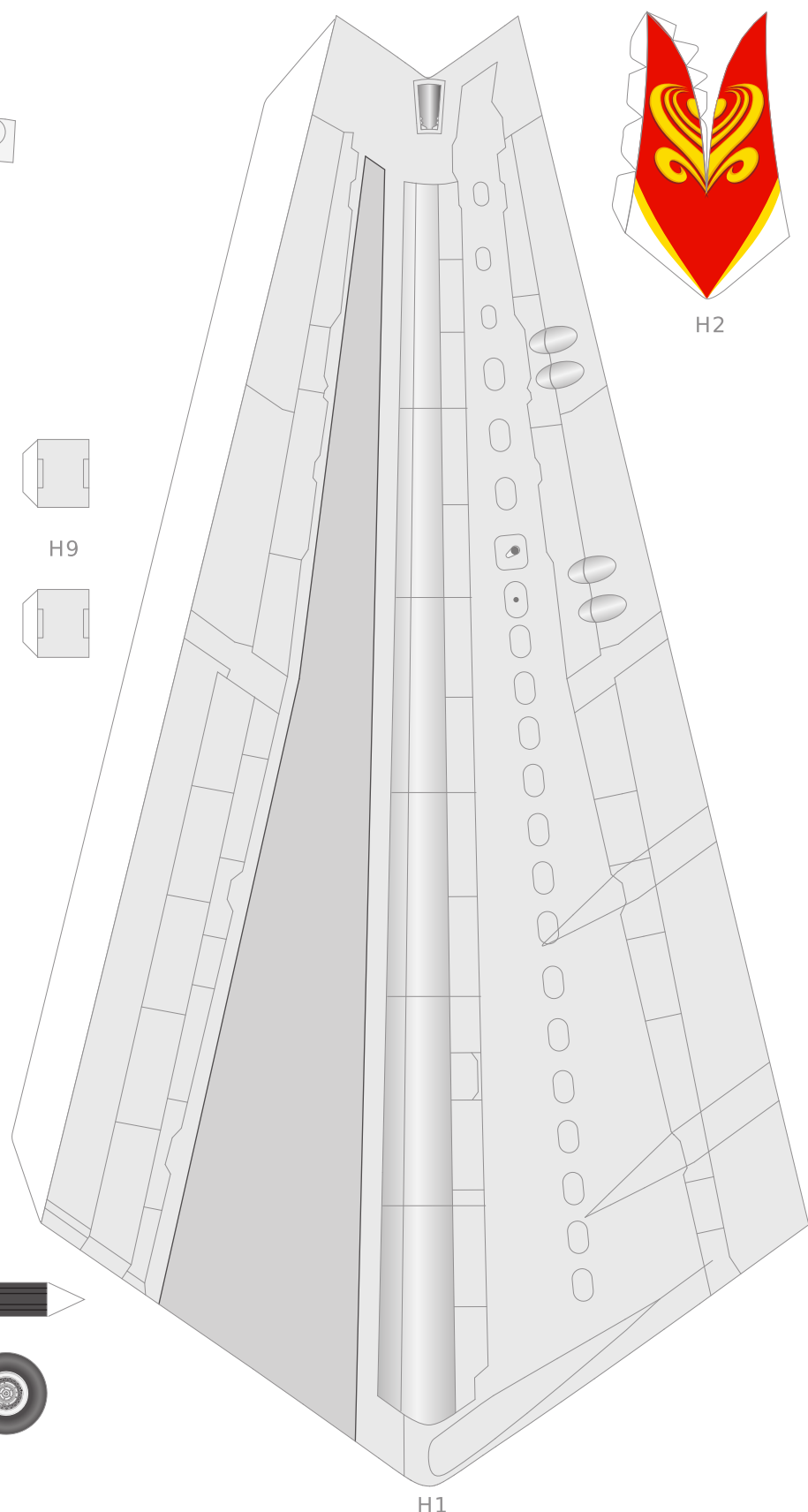

H1

H14

H15

H14

H15

H4

H3

H5

H9

H6

H8

H10

H7

H11

H12

H13

H13



12

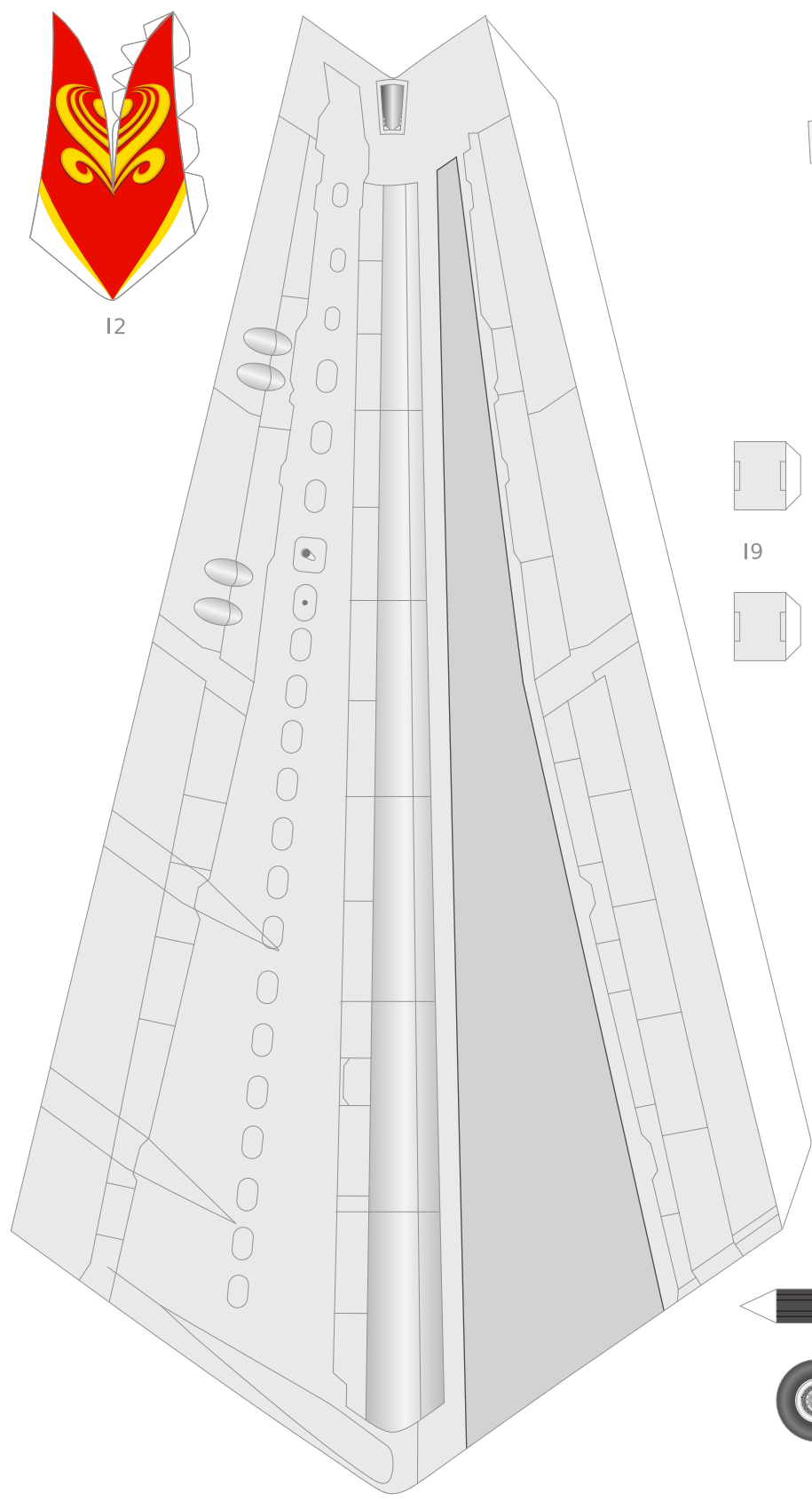

11

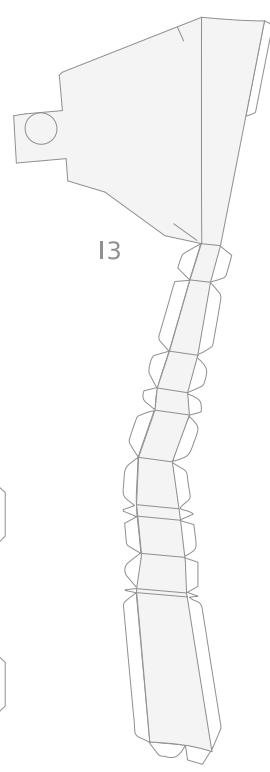

13

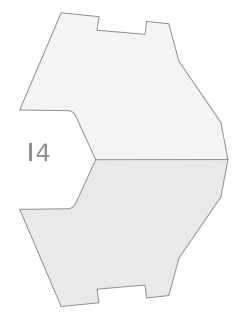

14



19

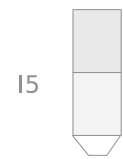

15



18

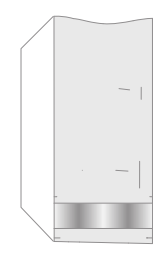

16

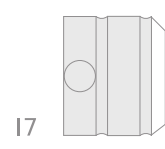

17

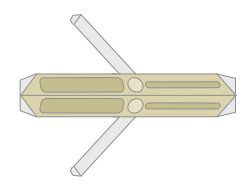

110

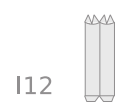

112



111

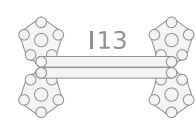

113

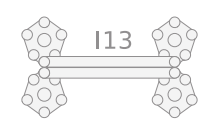

113



114



115



114



115

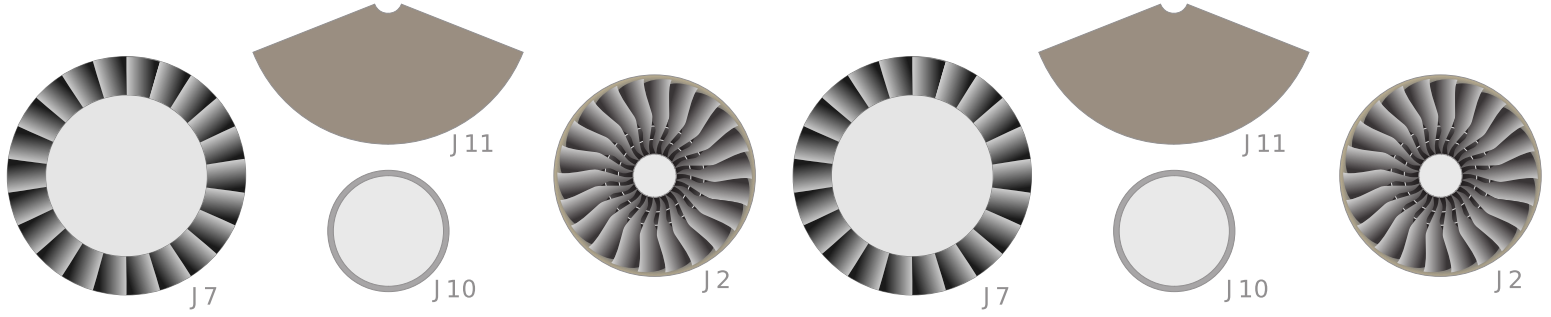
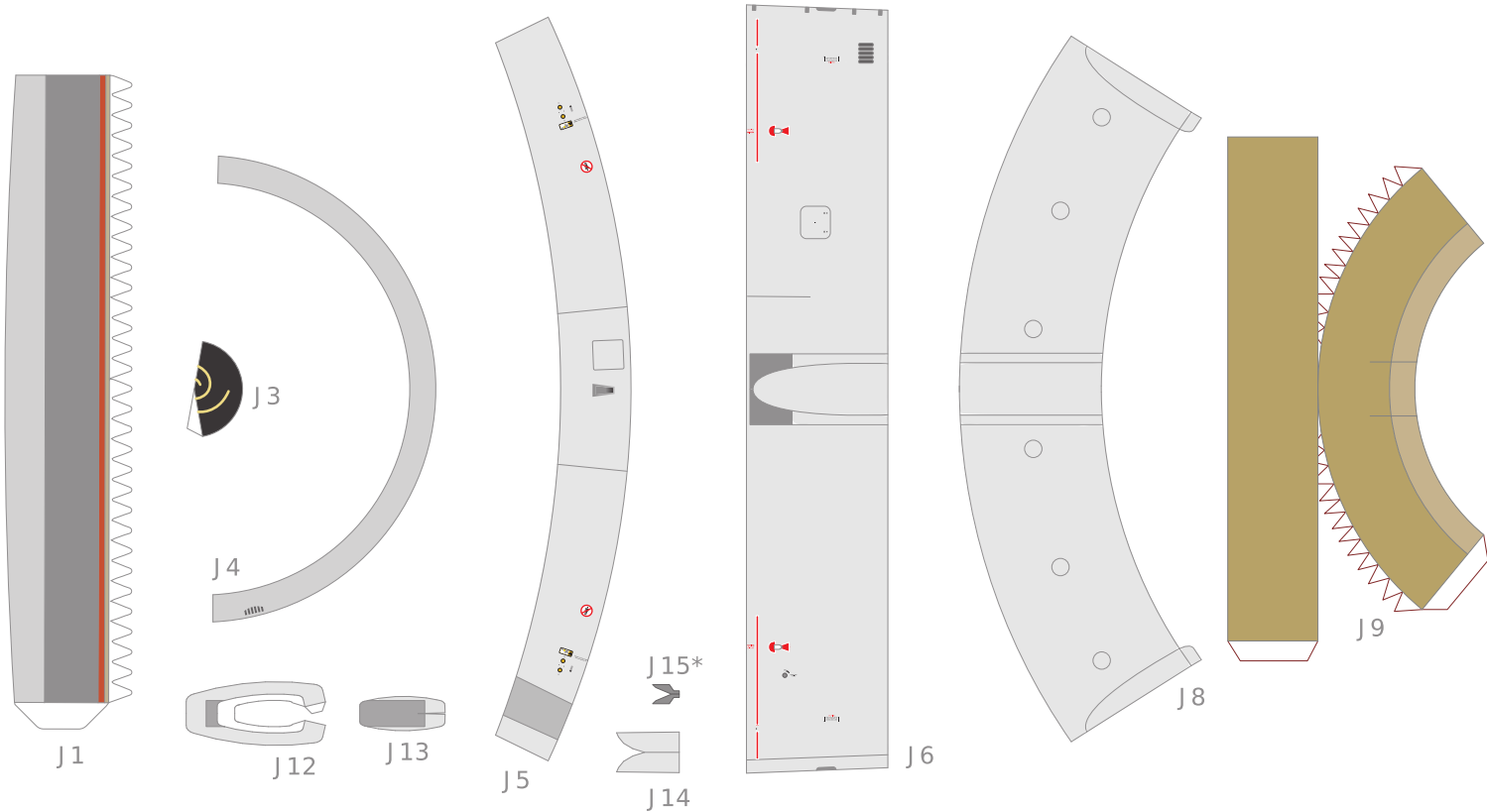
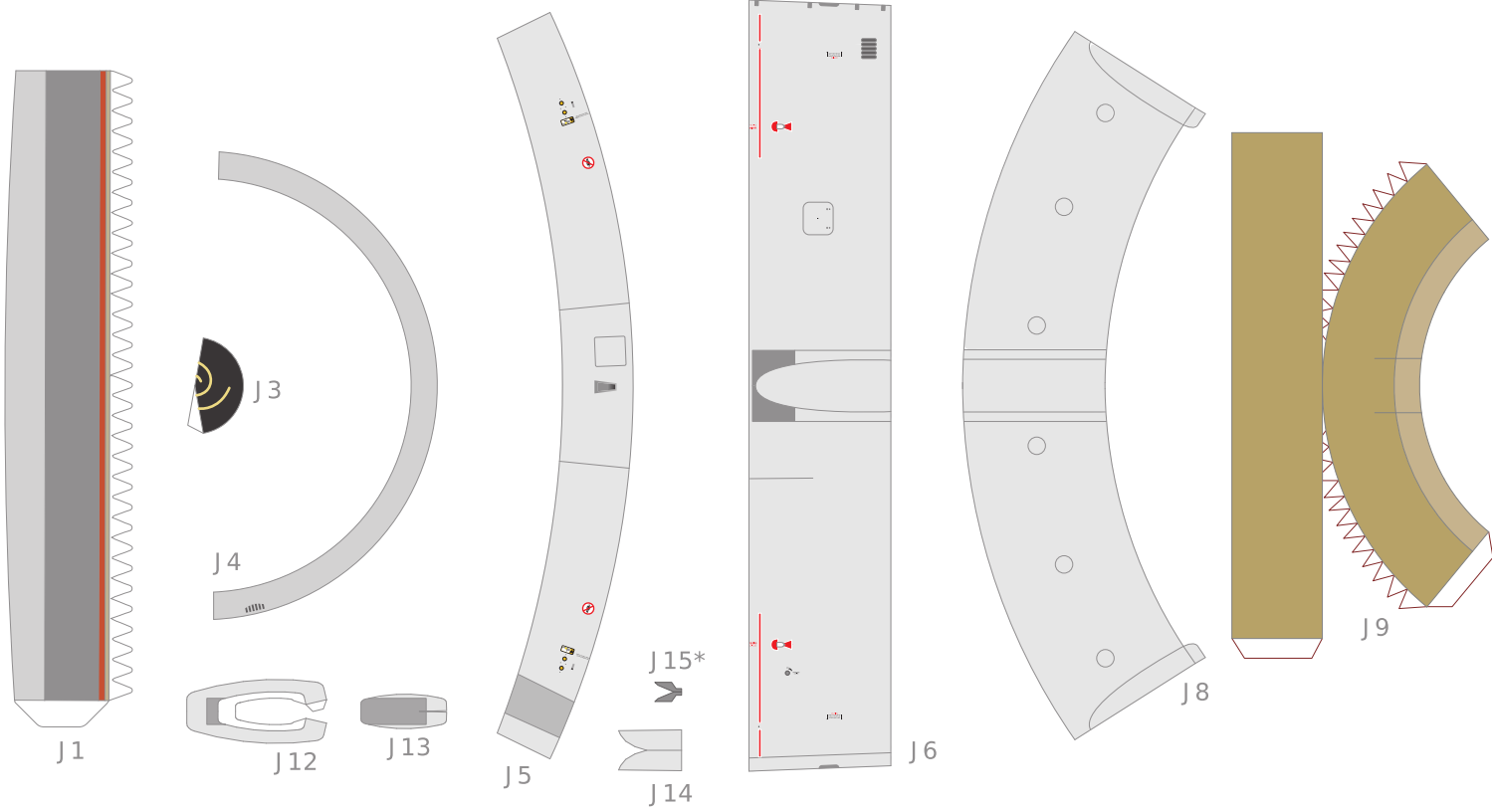

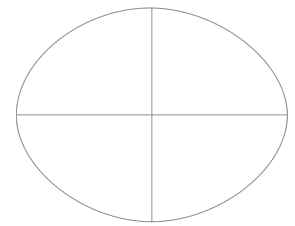
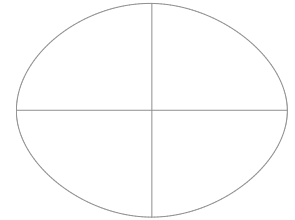
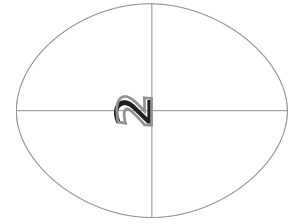
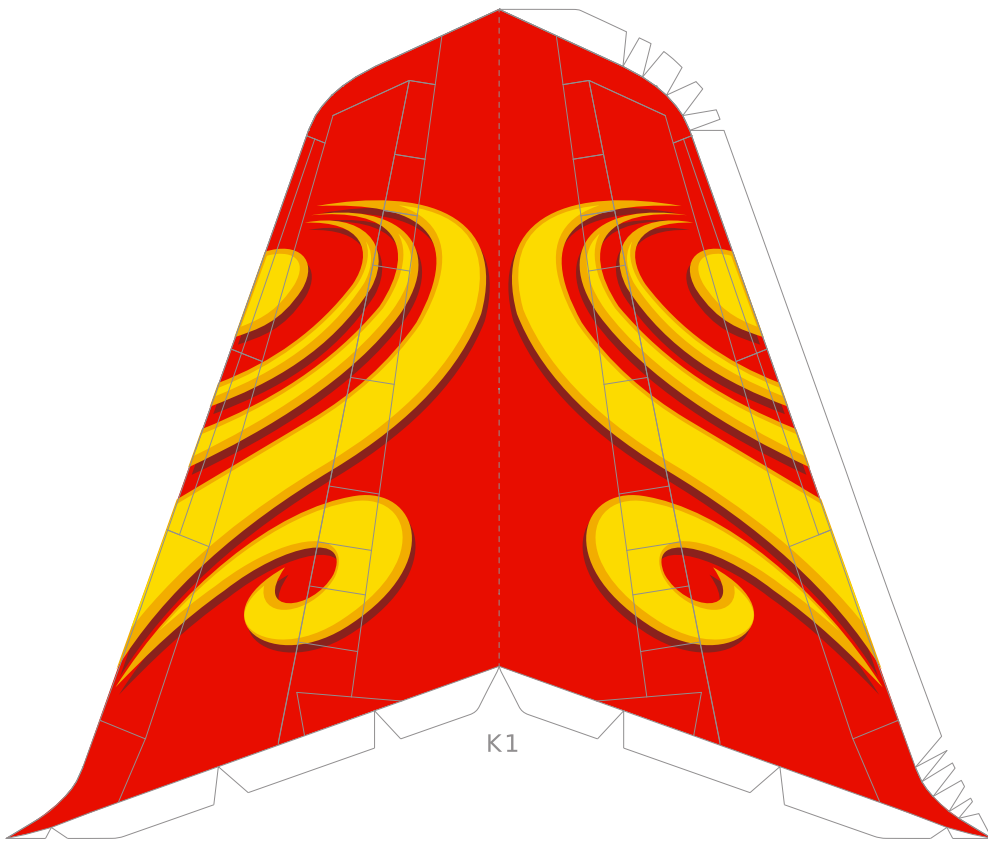

K2

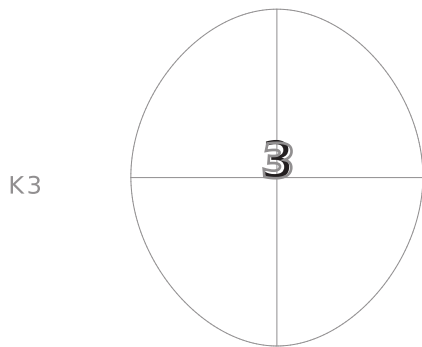

K3

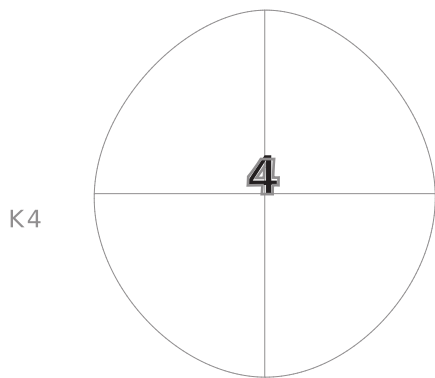
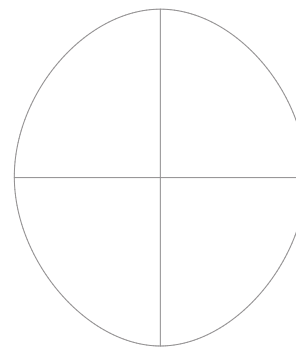
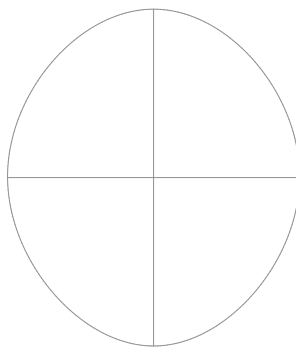

K4

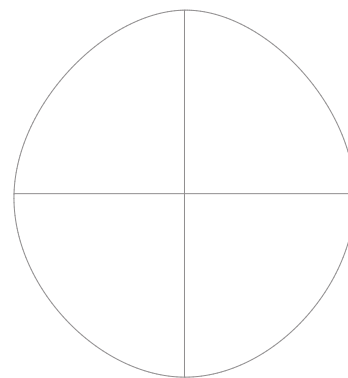
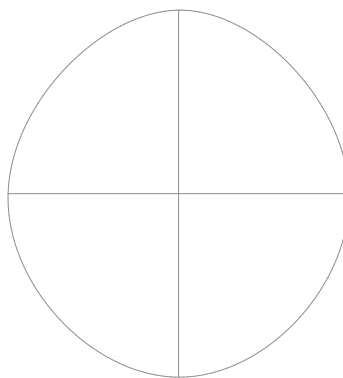

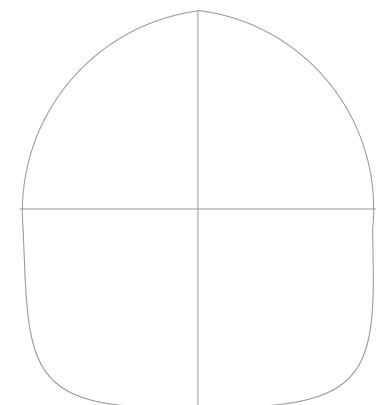
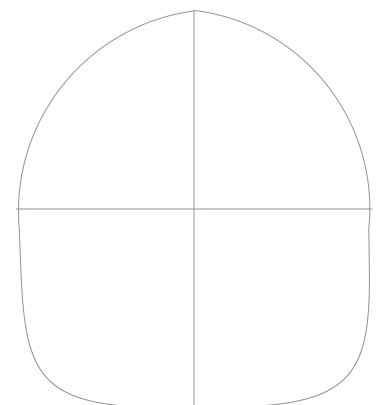
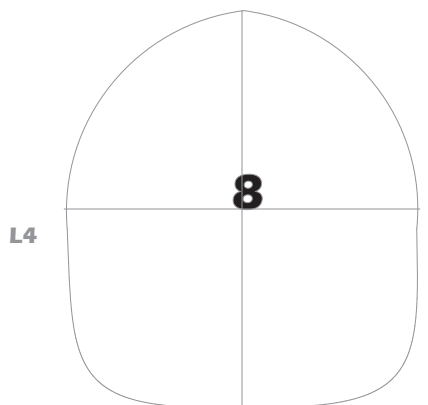
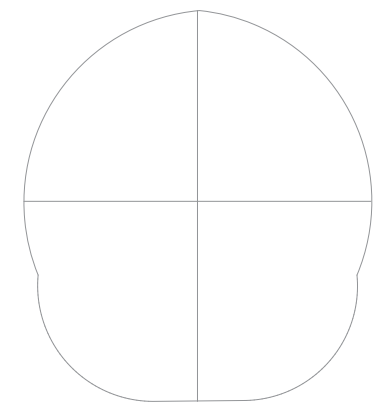
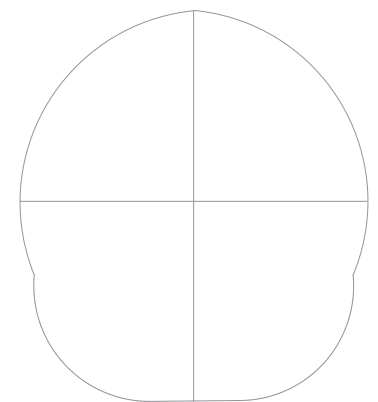
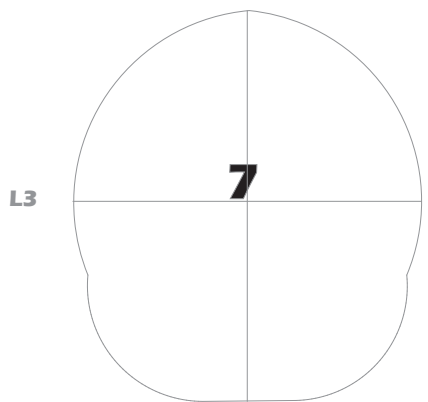
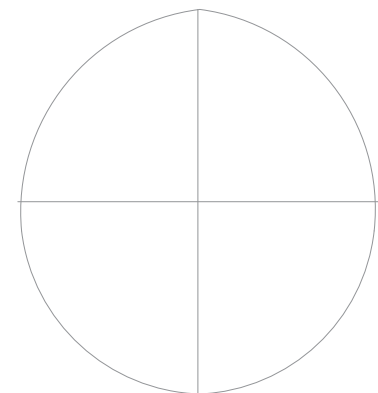
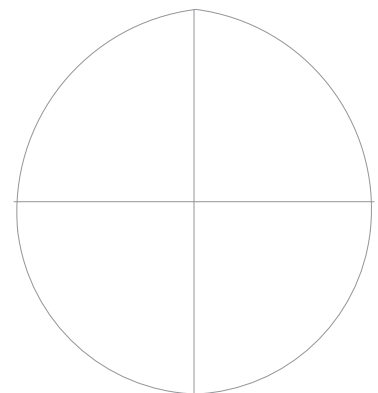
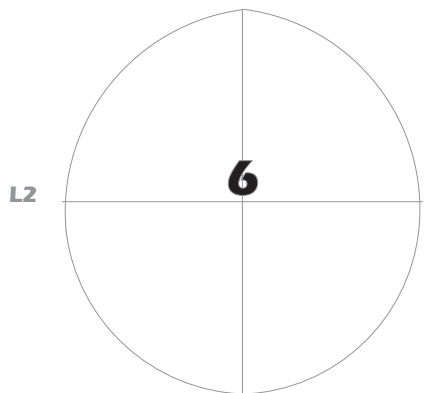
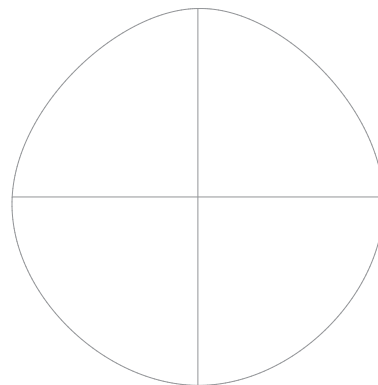
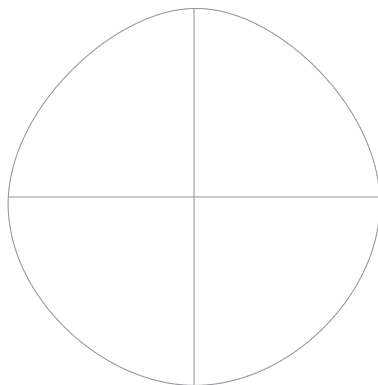
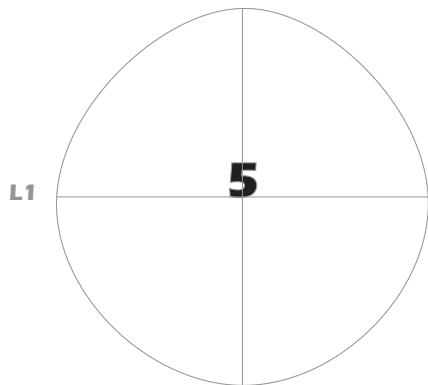

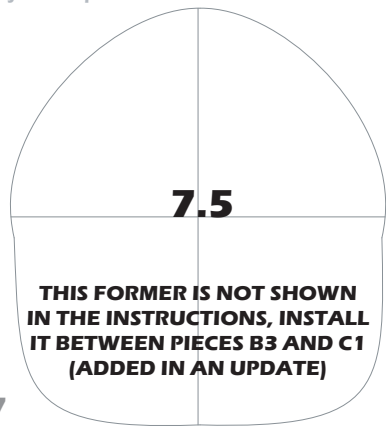

M7

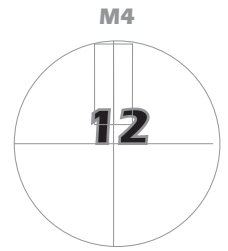
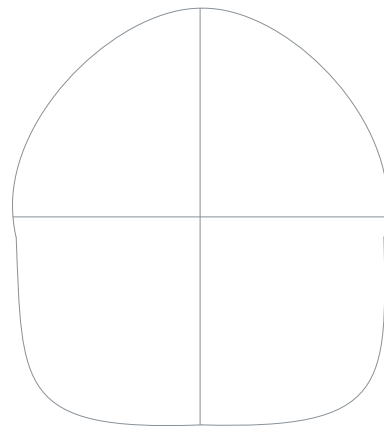
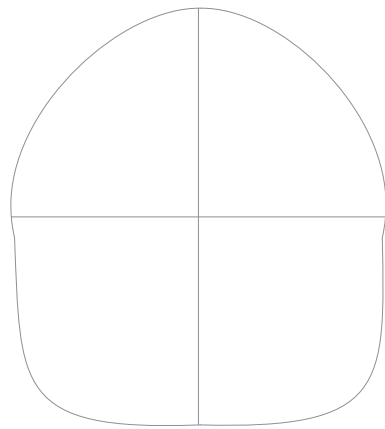

M4

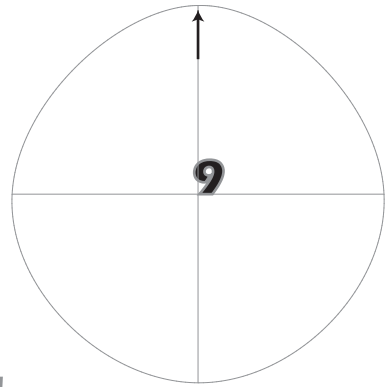
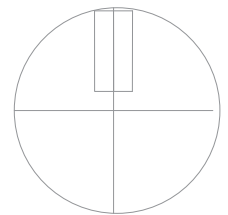
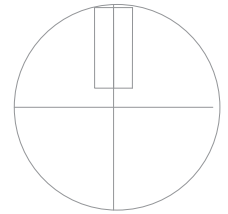

M1

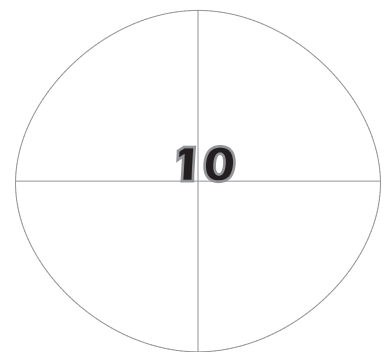
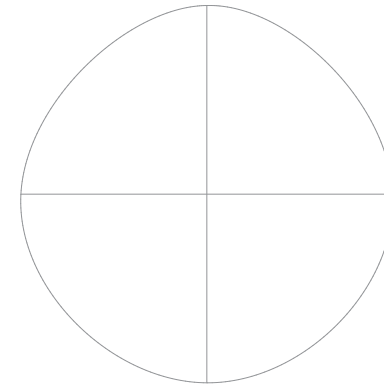
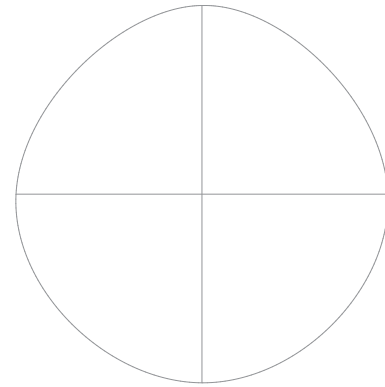

M2

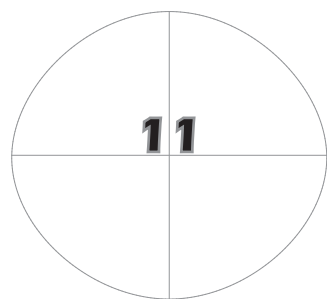
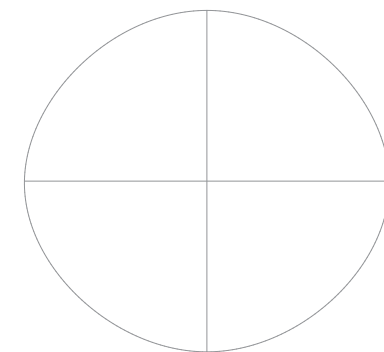
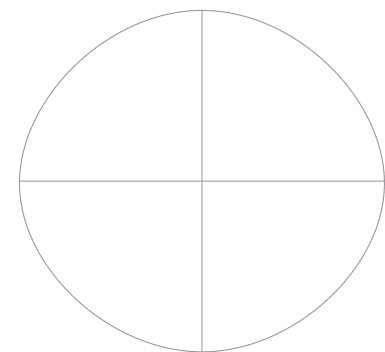

M3

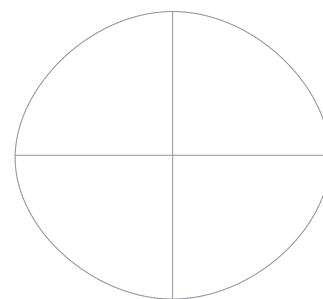
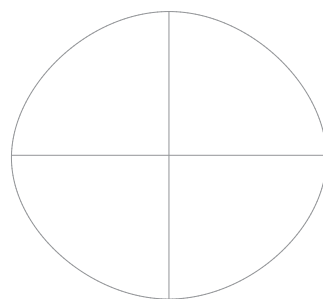

M5

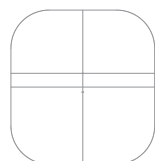
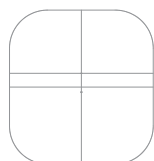

M6

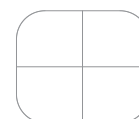
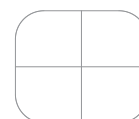

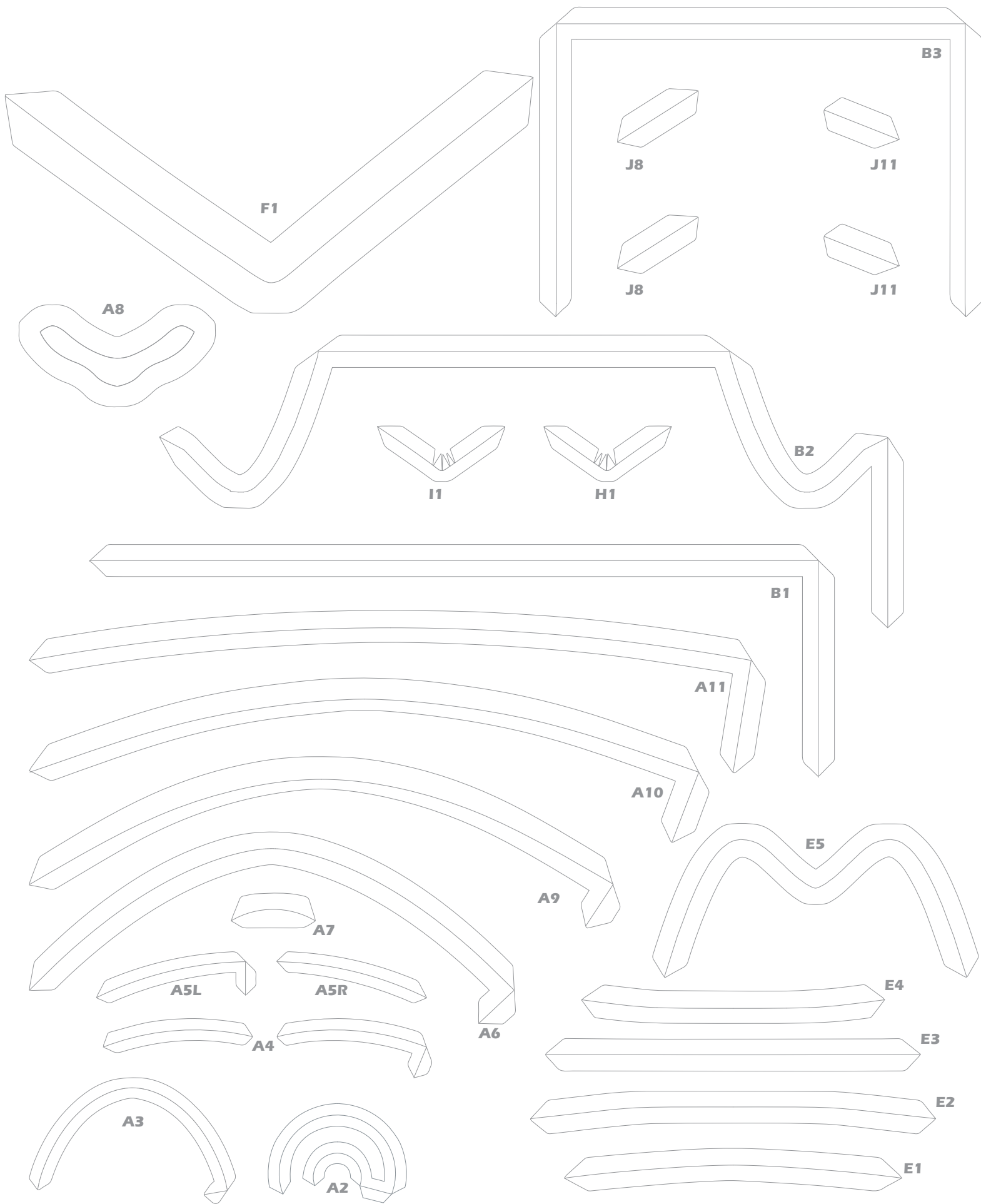

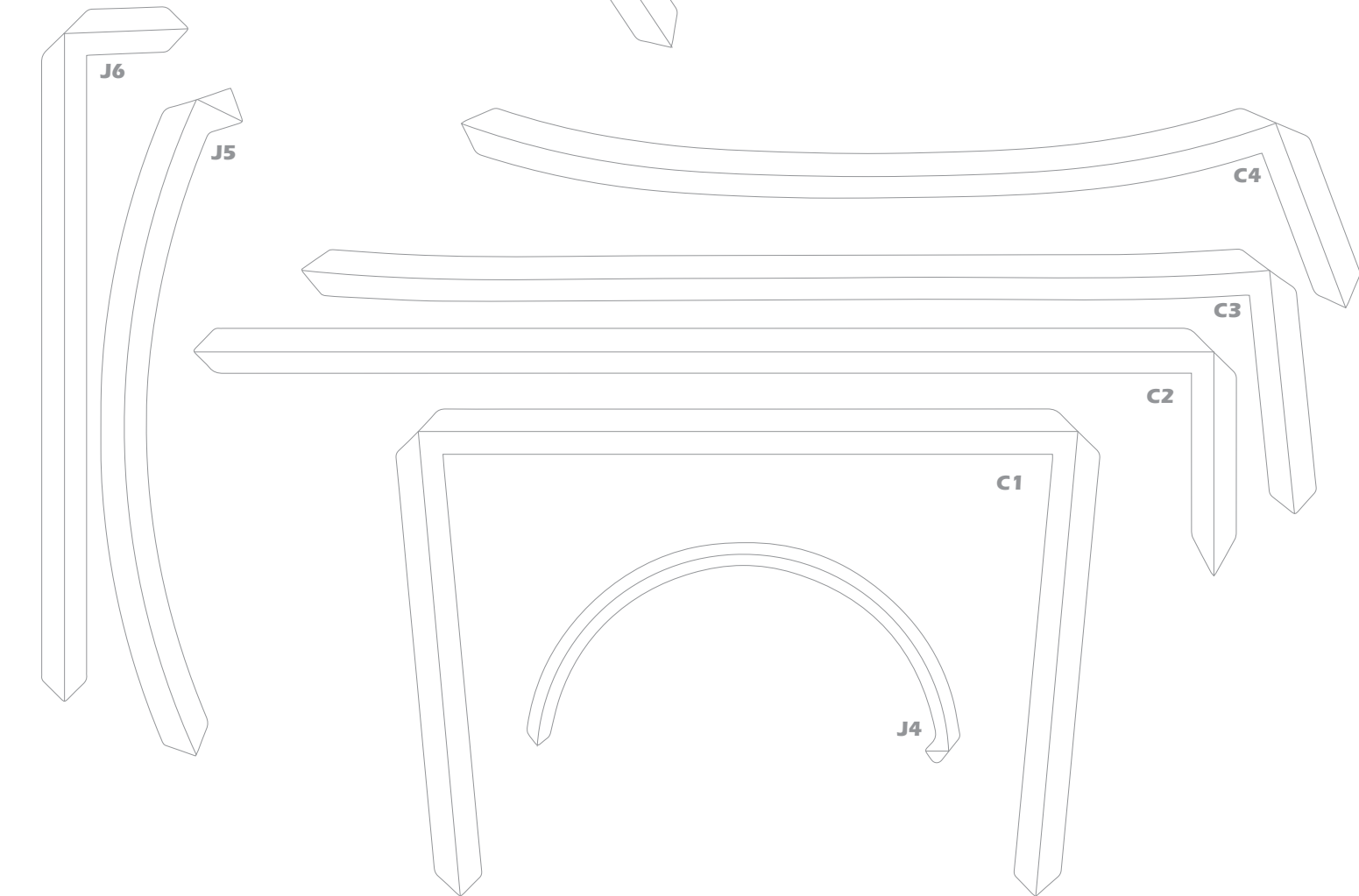
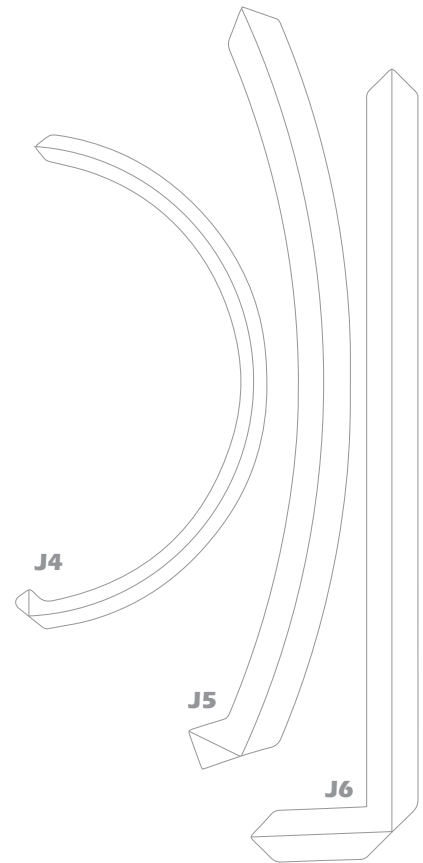
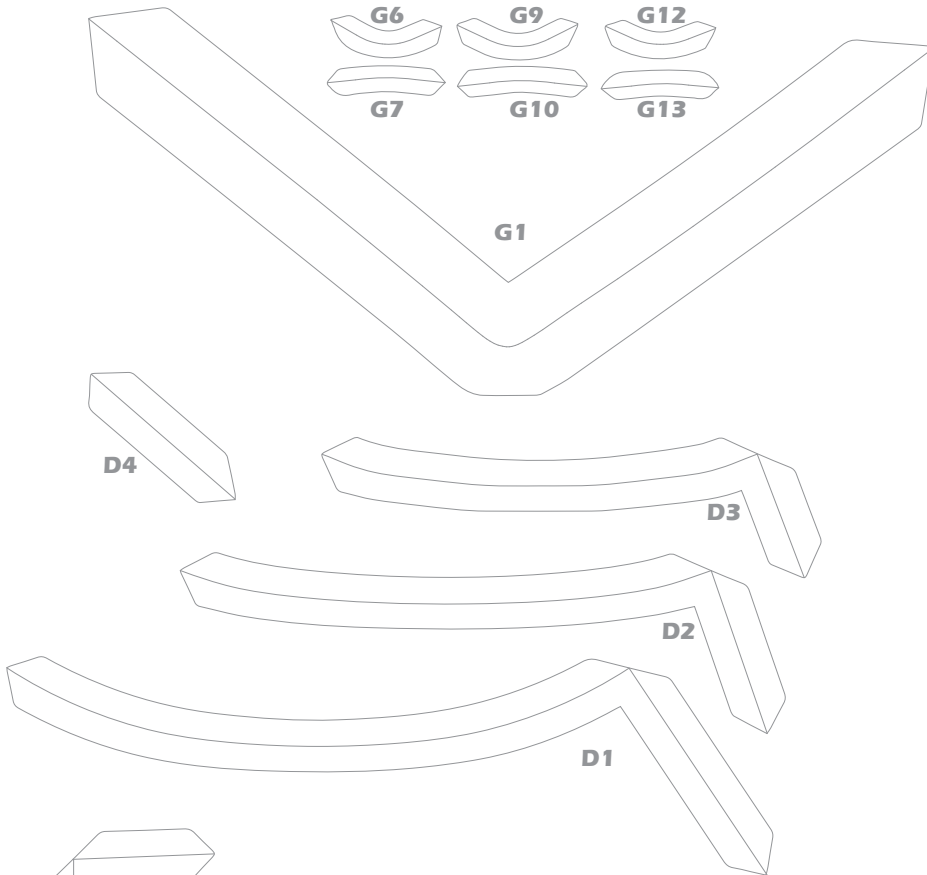
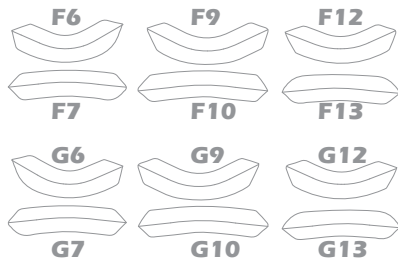

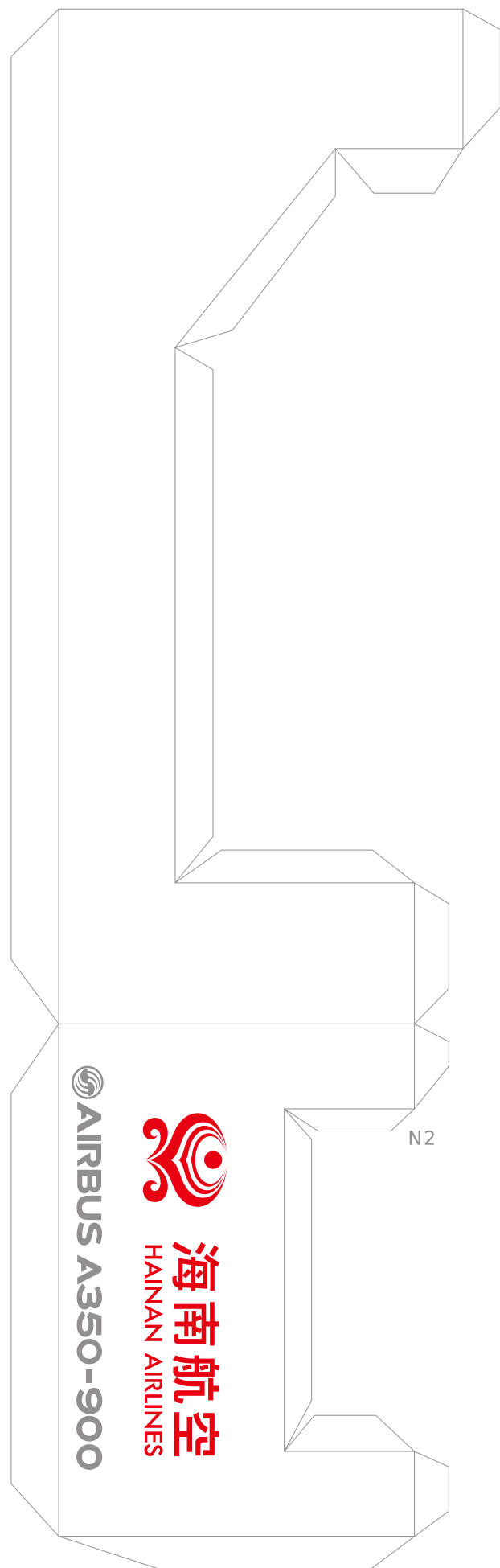
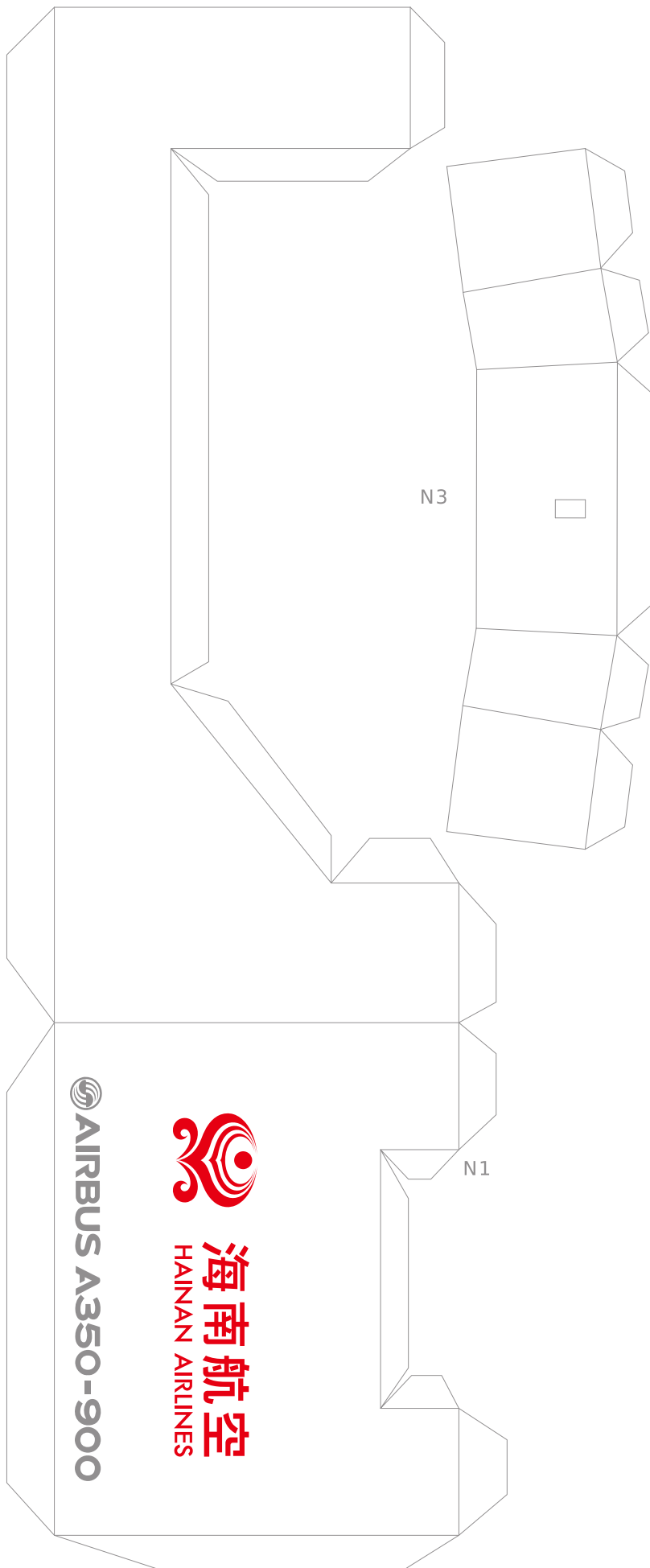

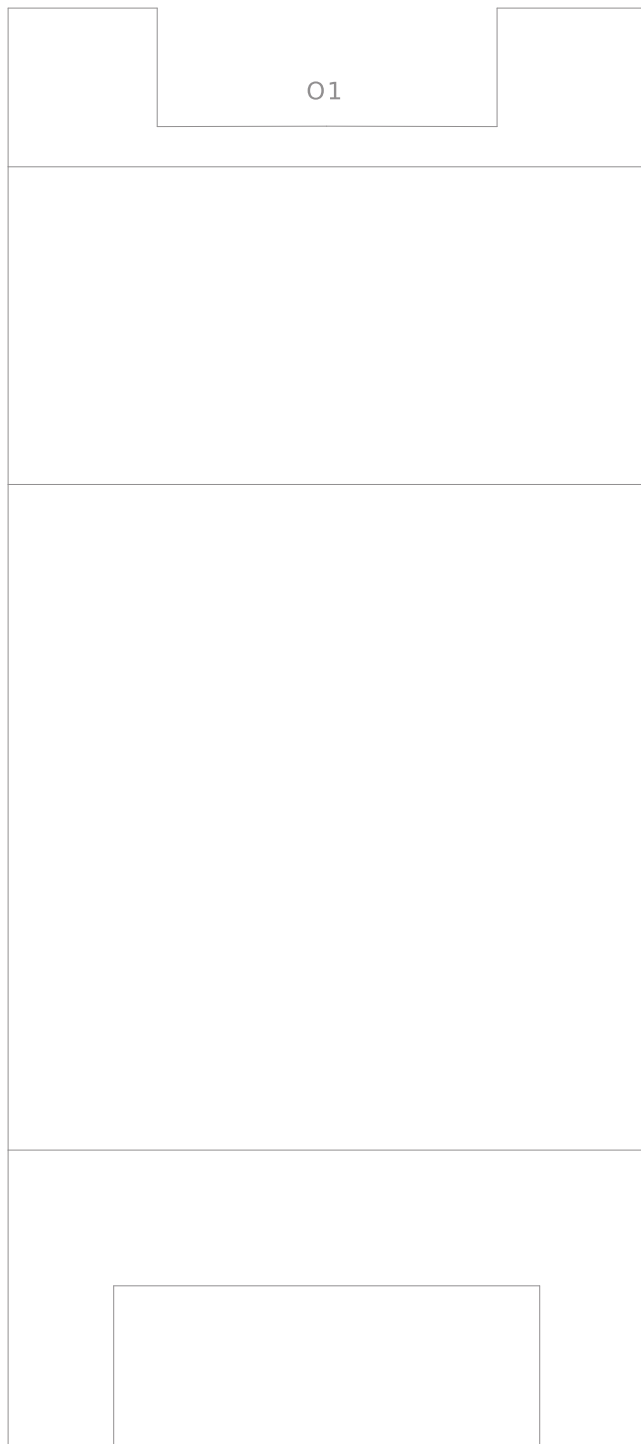

O3

ORIGINAL MODEL DESIGNED BY EDWIN RODRIGUEZ



PLEASE DO NOT SELL THIS FILE | DESIGNED IN PALMARES, COSTA RICA