

- B5* 
- B7* 
- B9* 
- B6* 
- B8* 
- B10* 

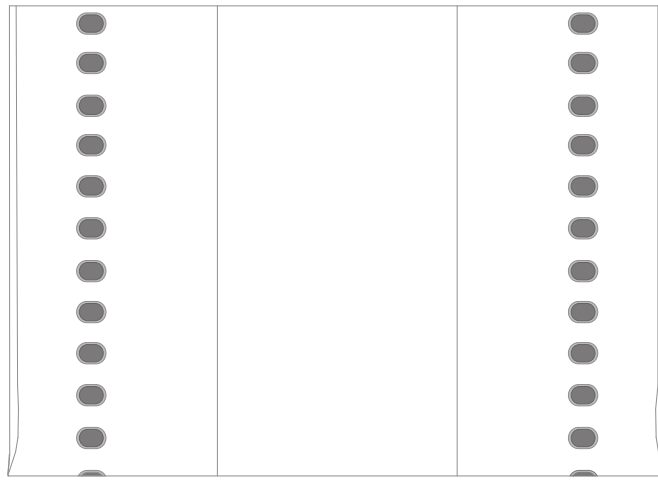

B3

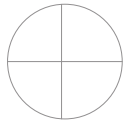
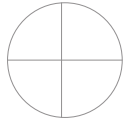
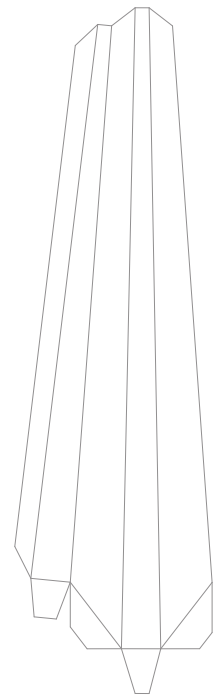

B13

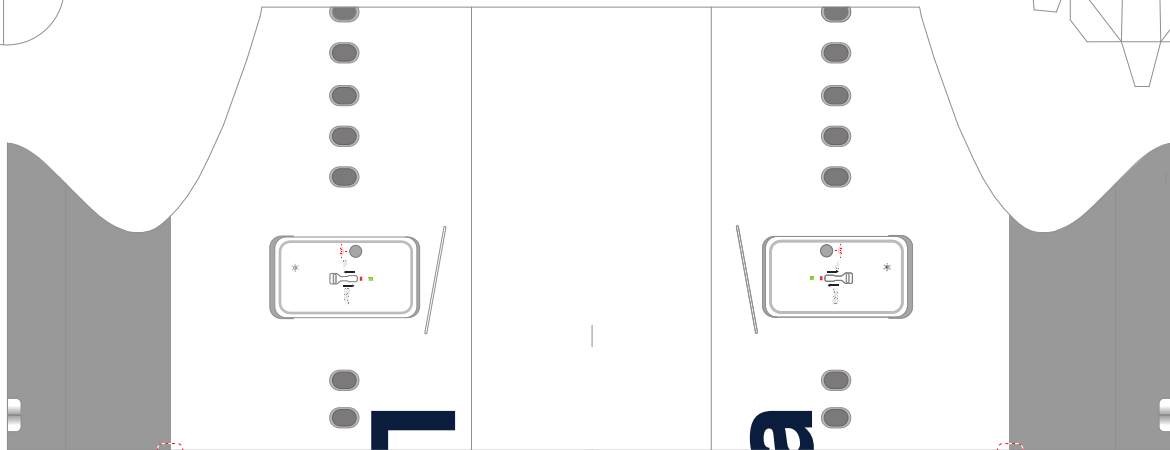

B2



B1

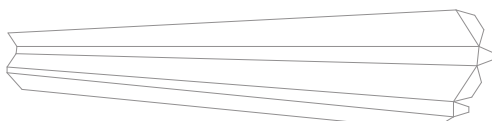

B12R

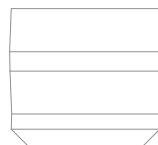

B11



B12L

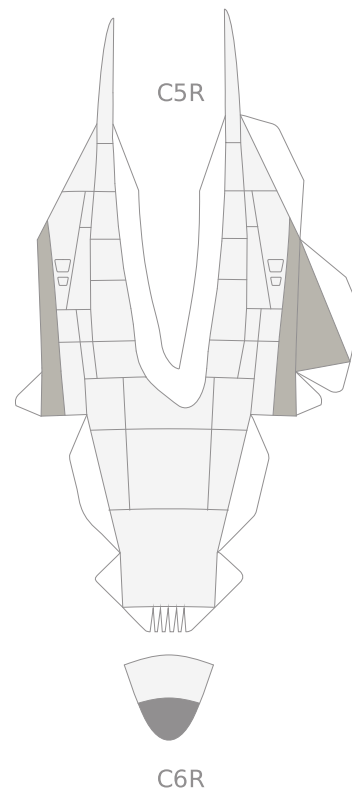
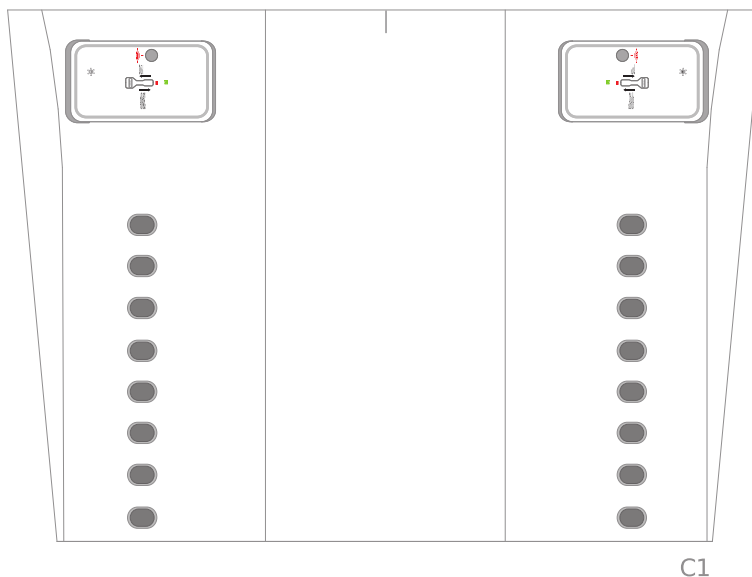
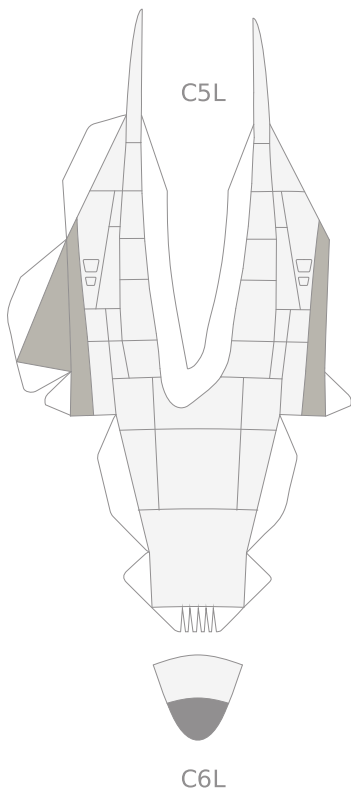
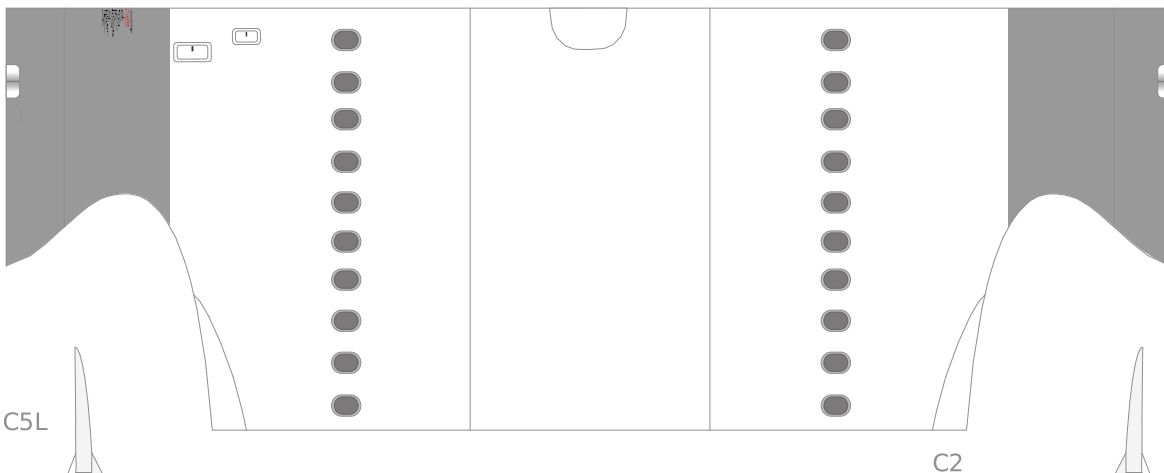
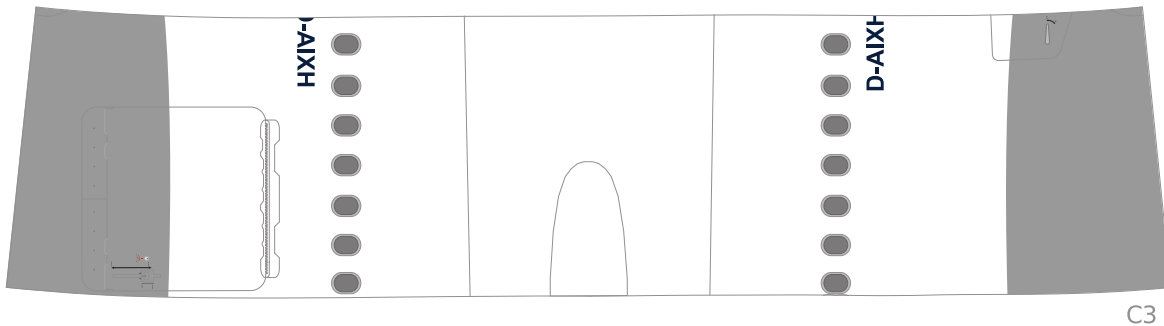
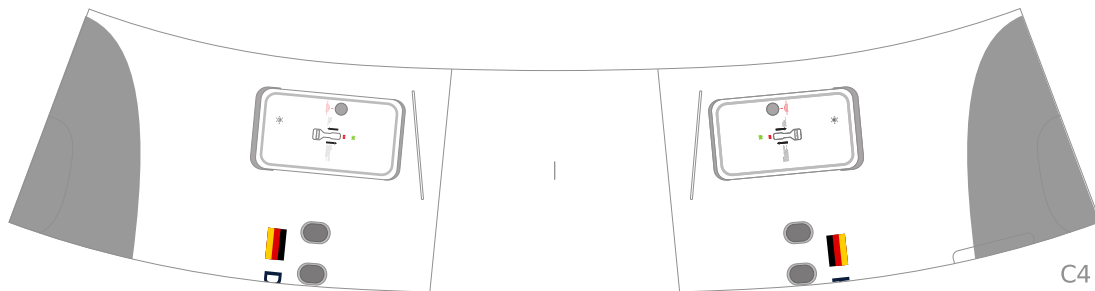

C6L

C1

C6R

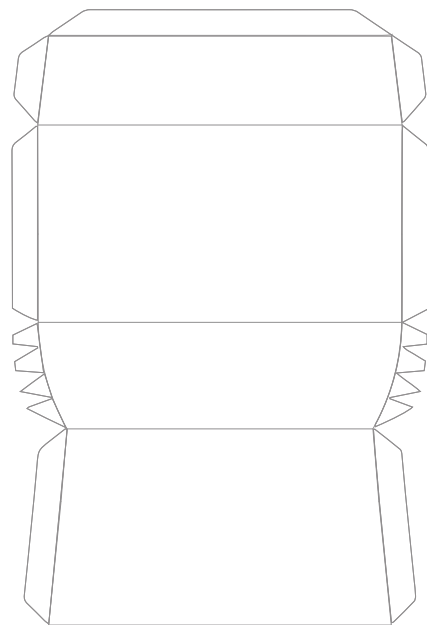
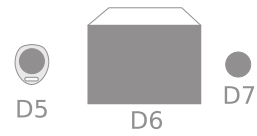
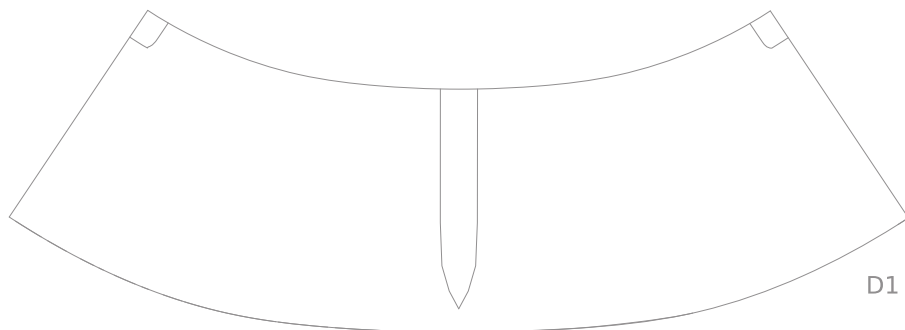
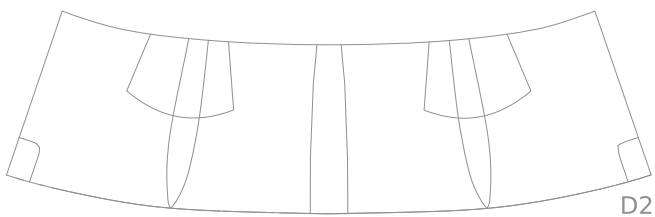
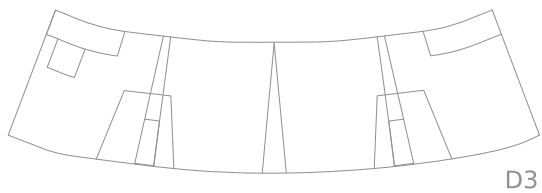
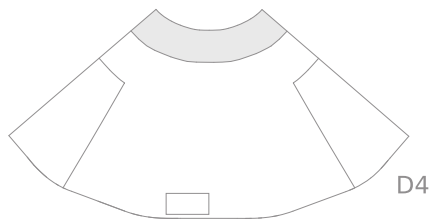
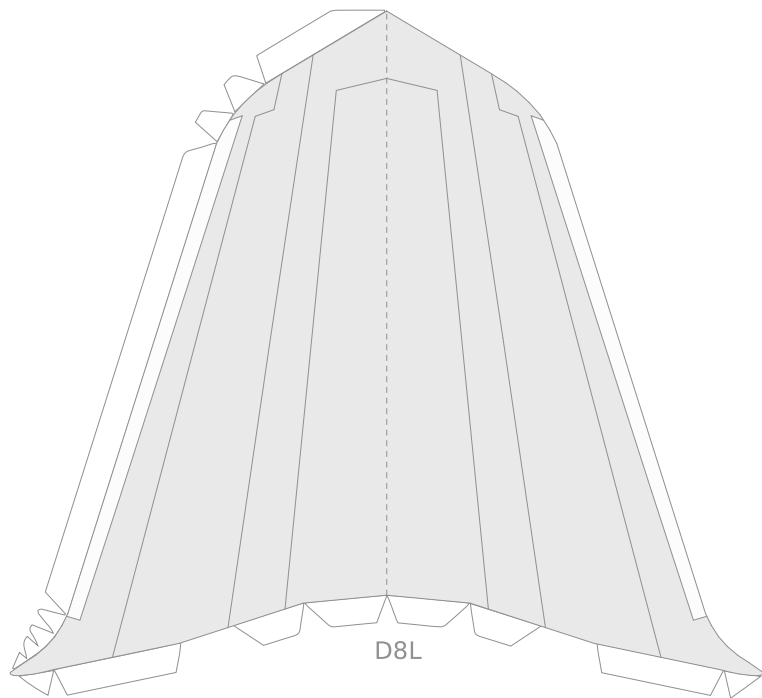
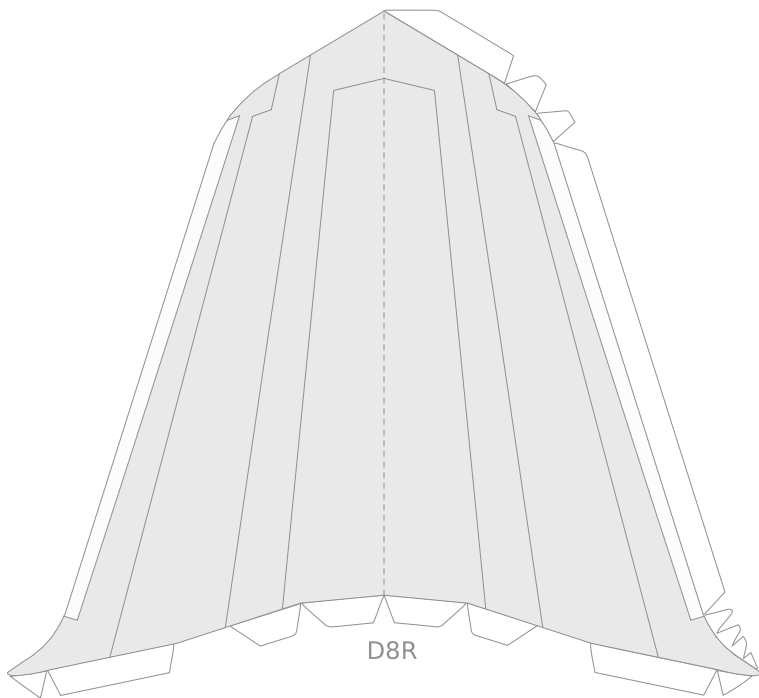

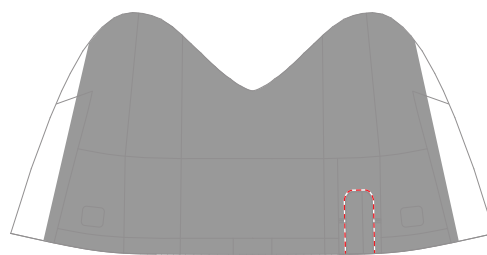
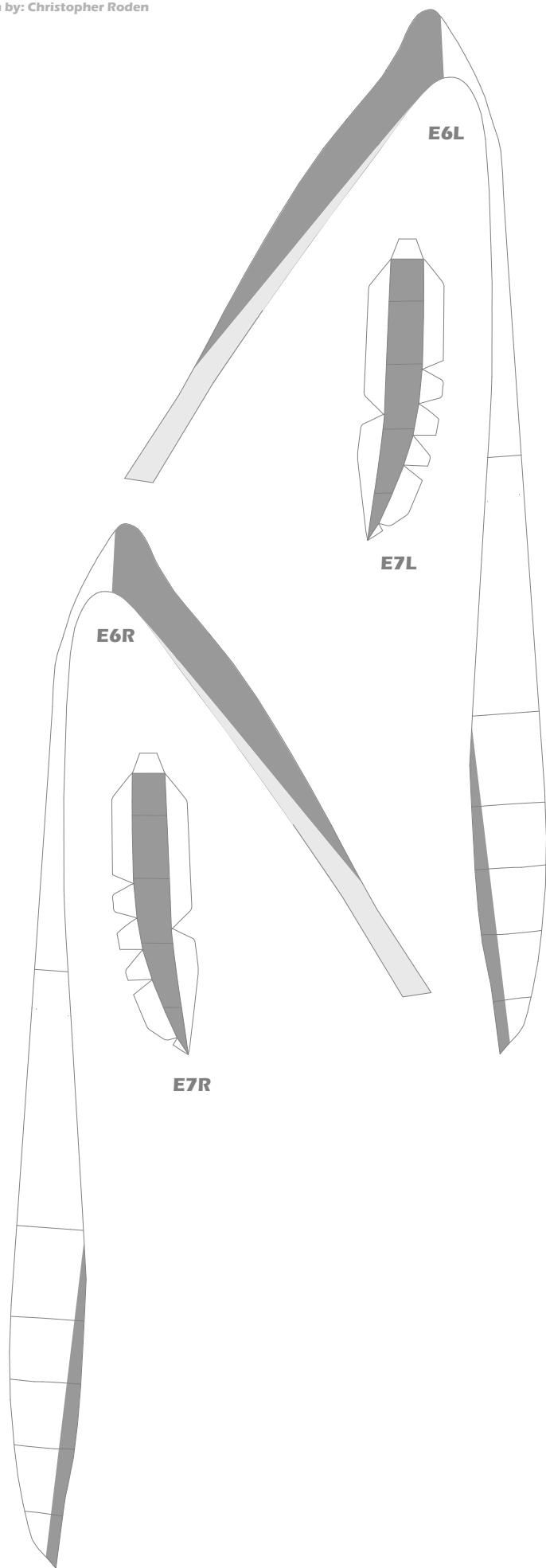

E5

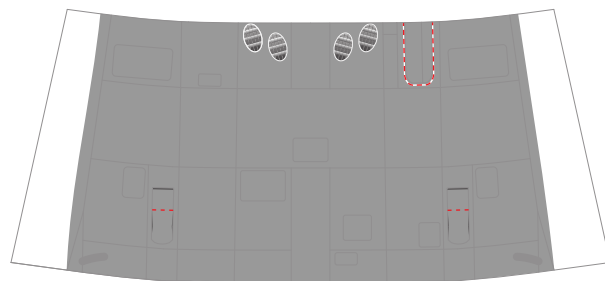

E4

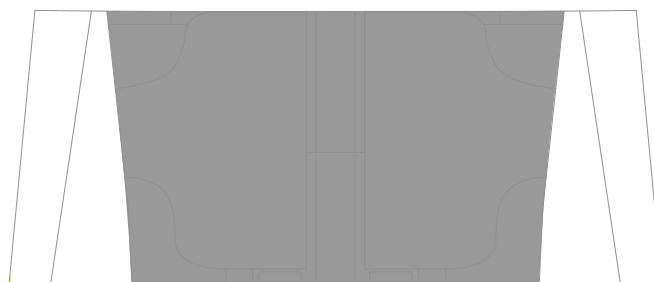

E3

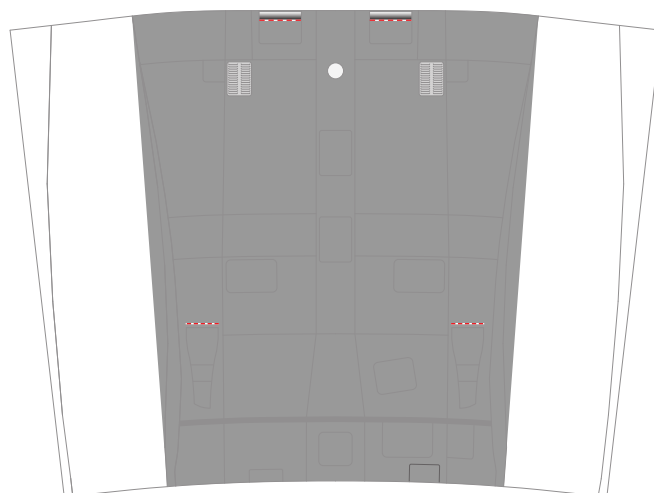

E2

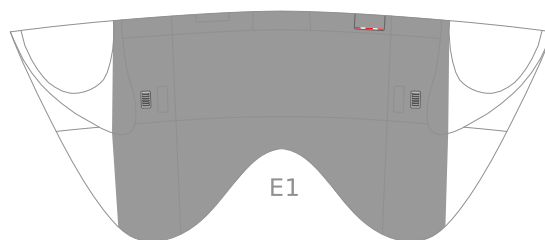

E1

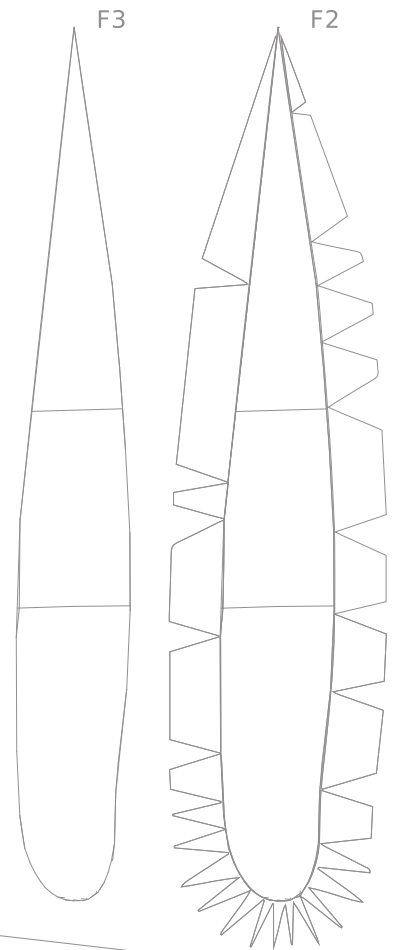
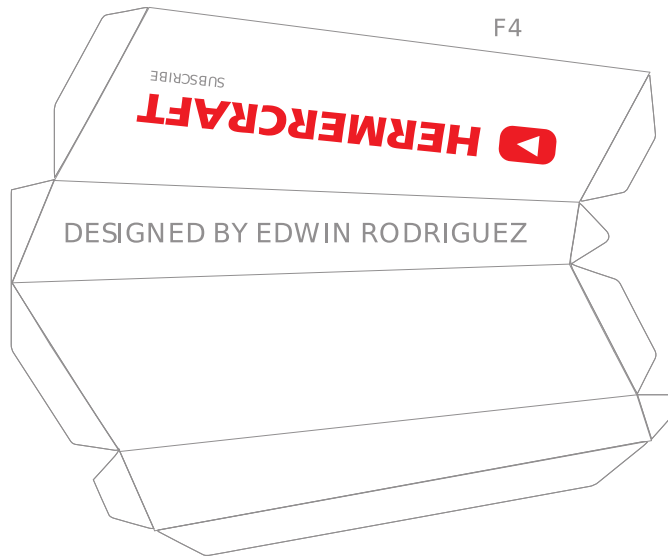
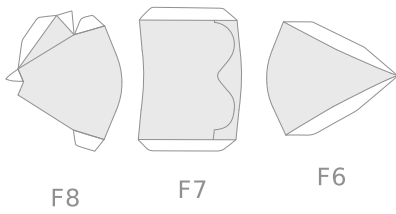
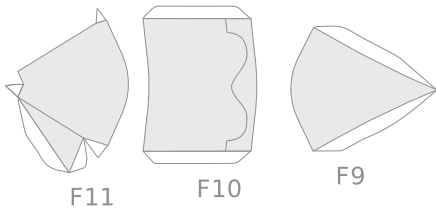
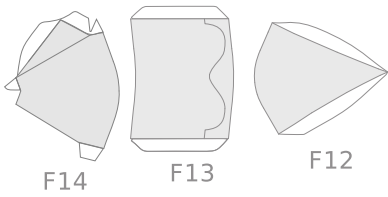
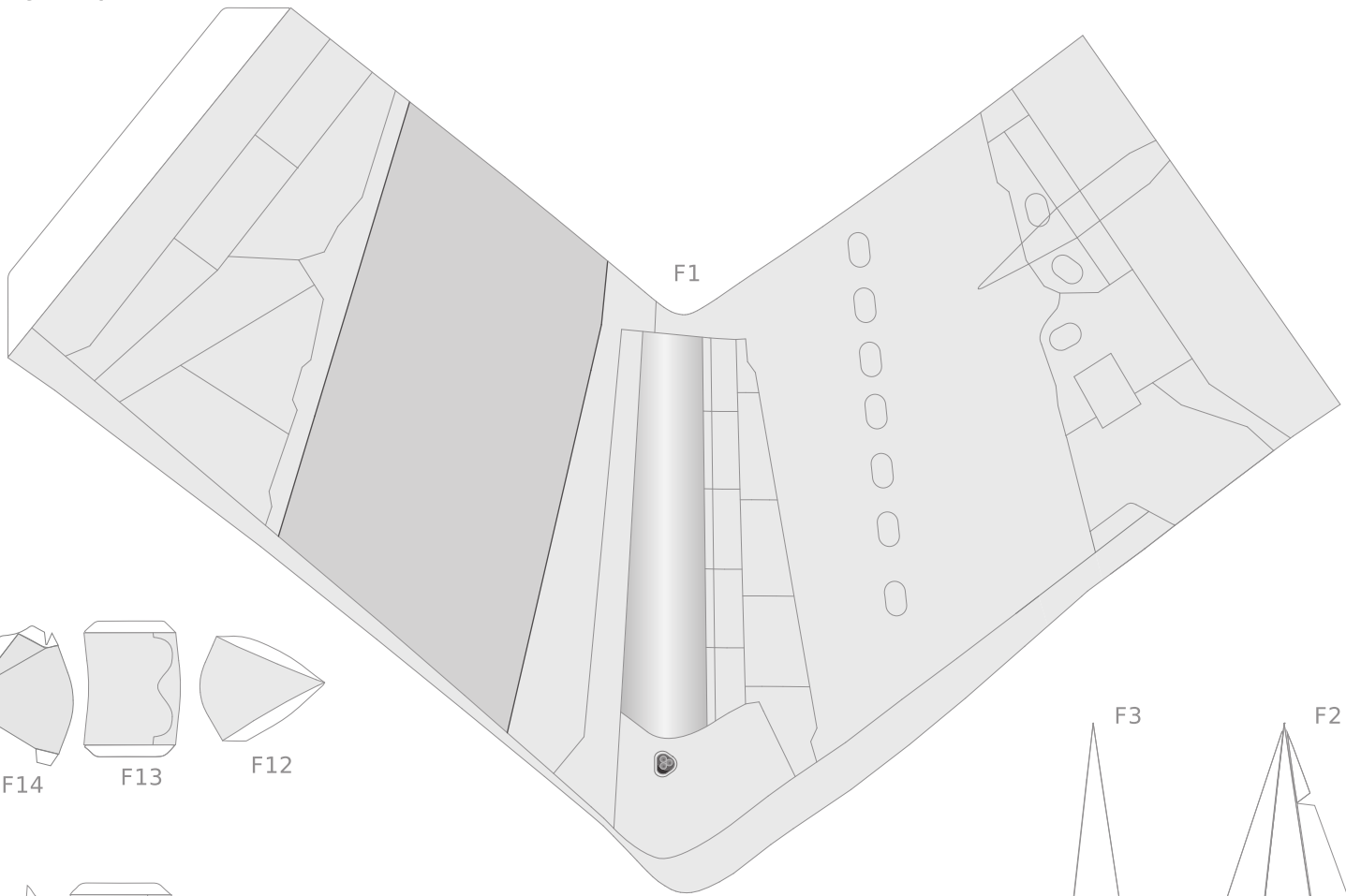

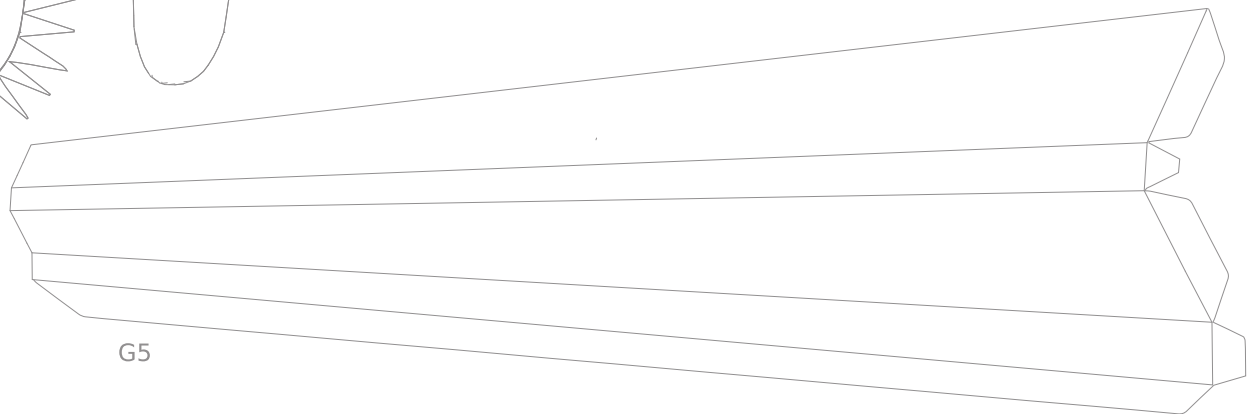
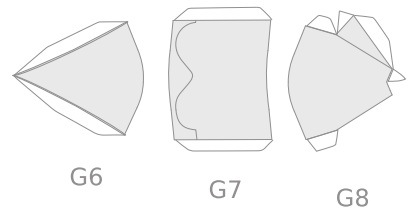
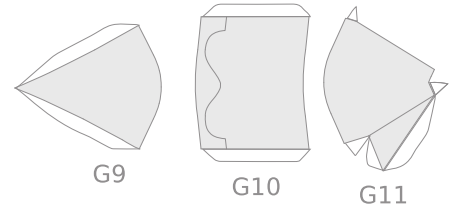
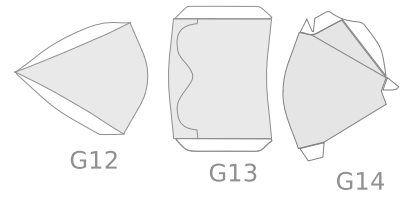
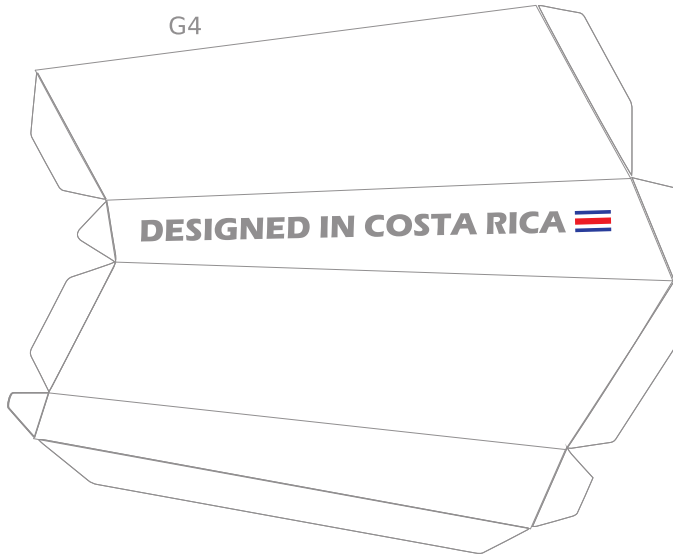
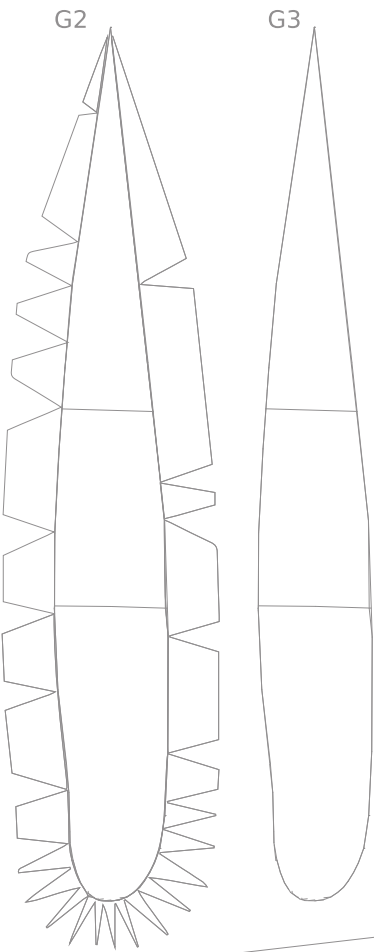
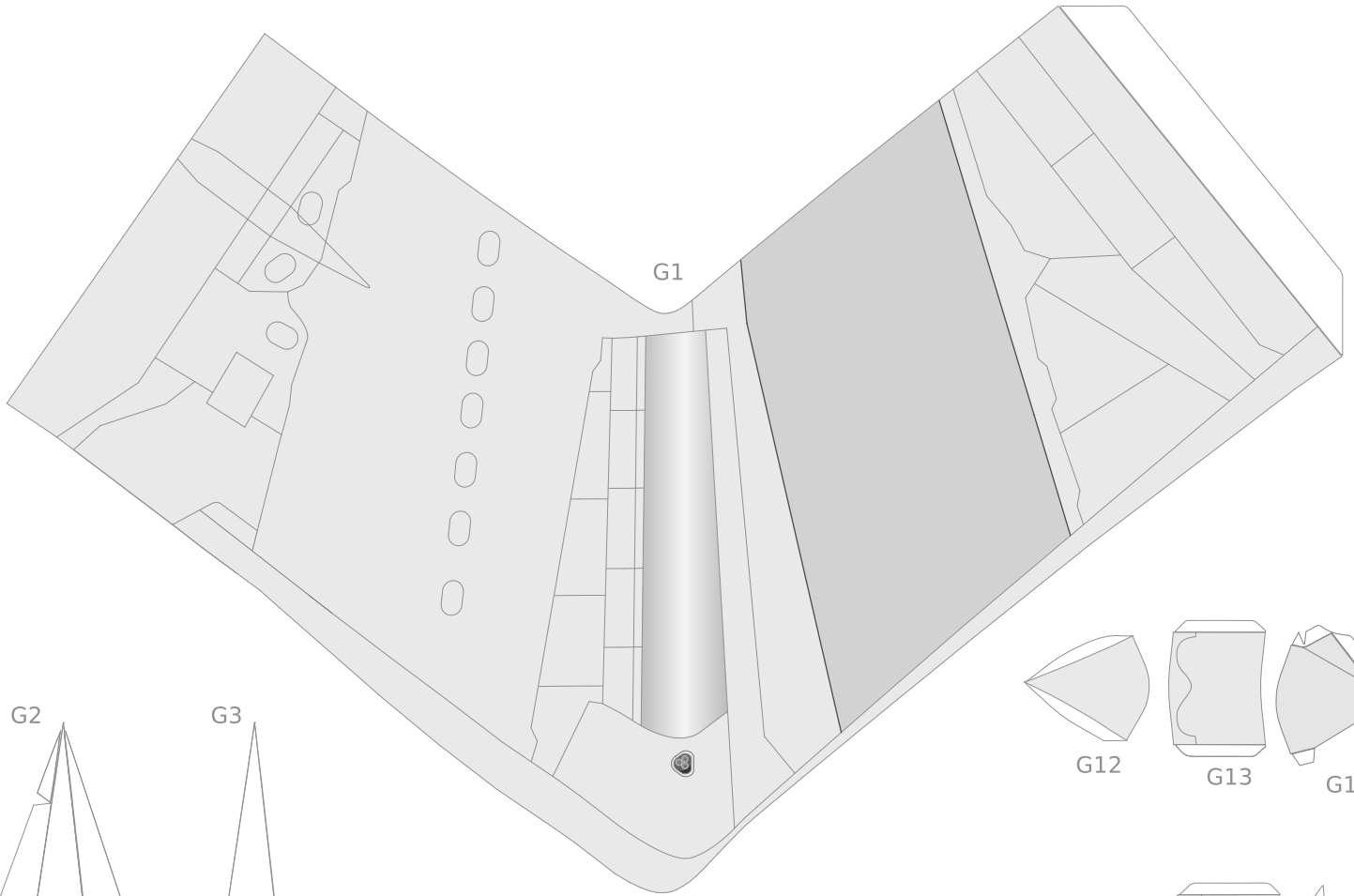

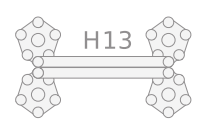
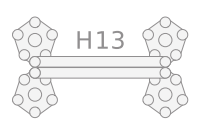
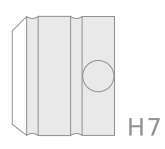
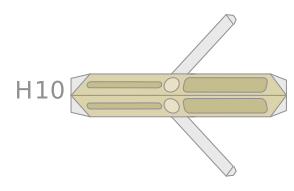
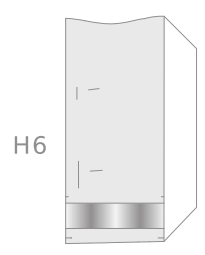
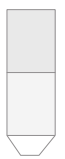
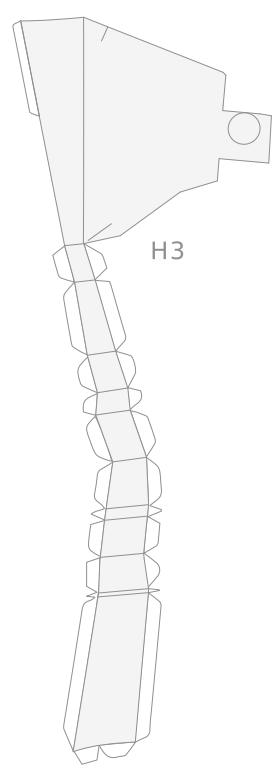
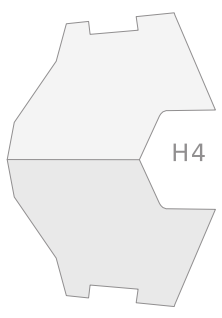
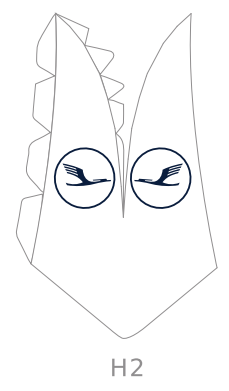
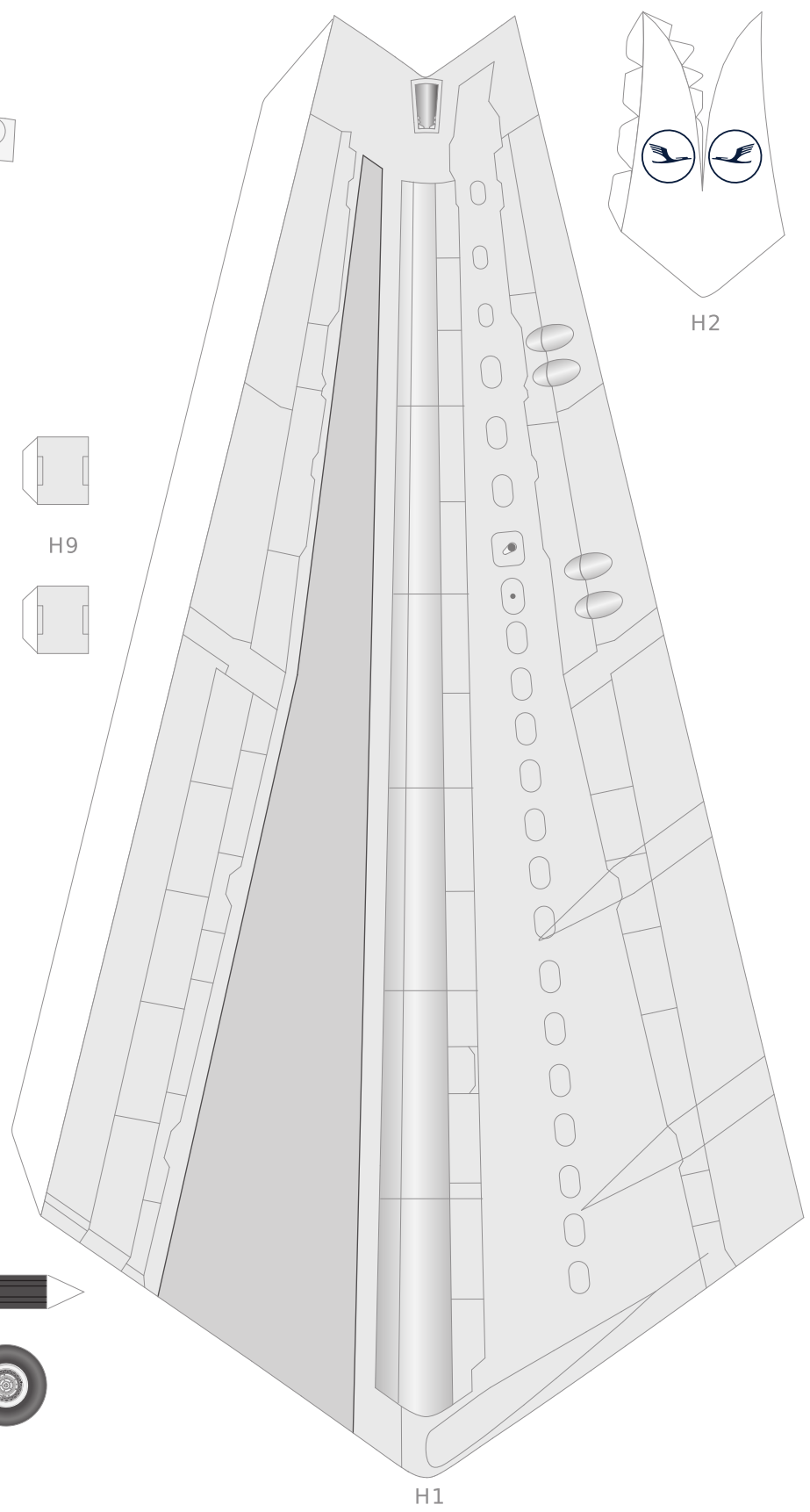

H14



H15



H14



H15



H1

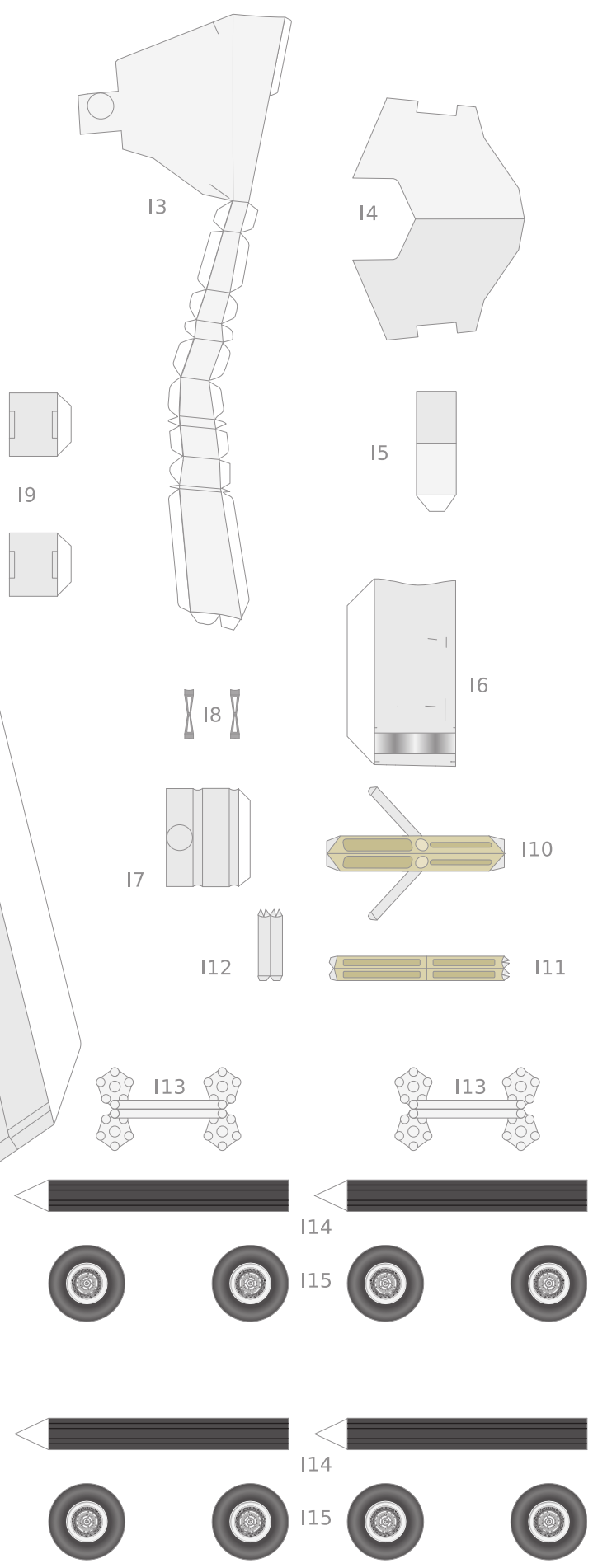
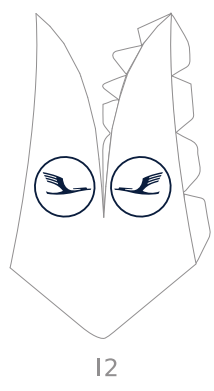
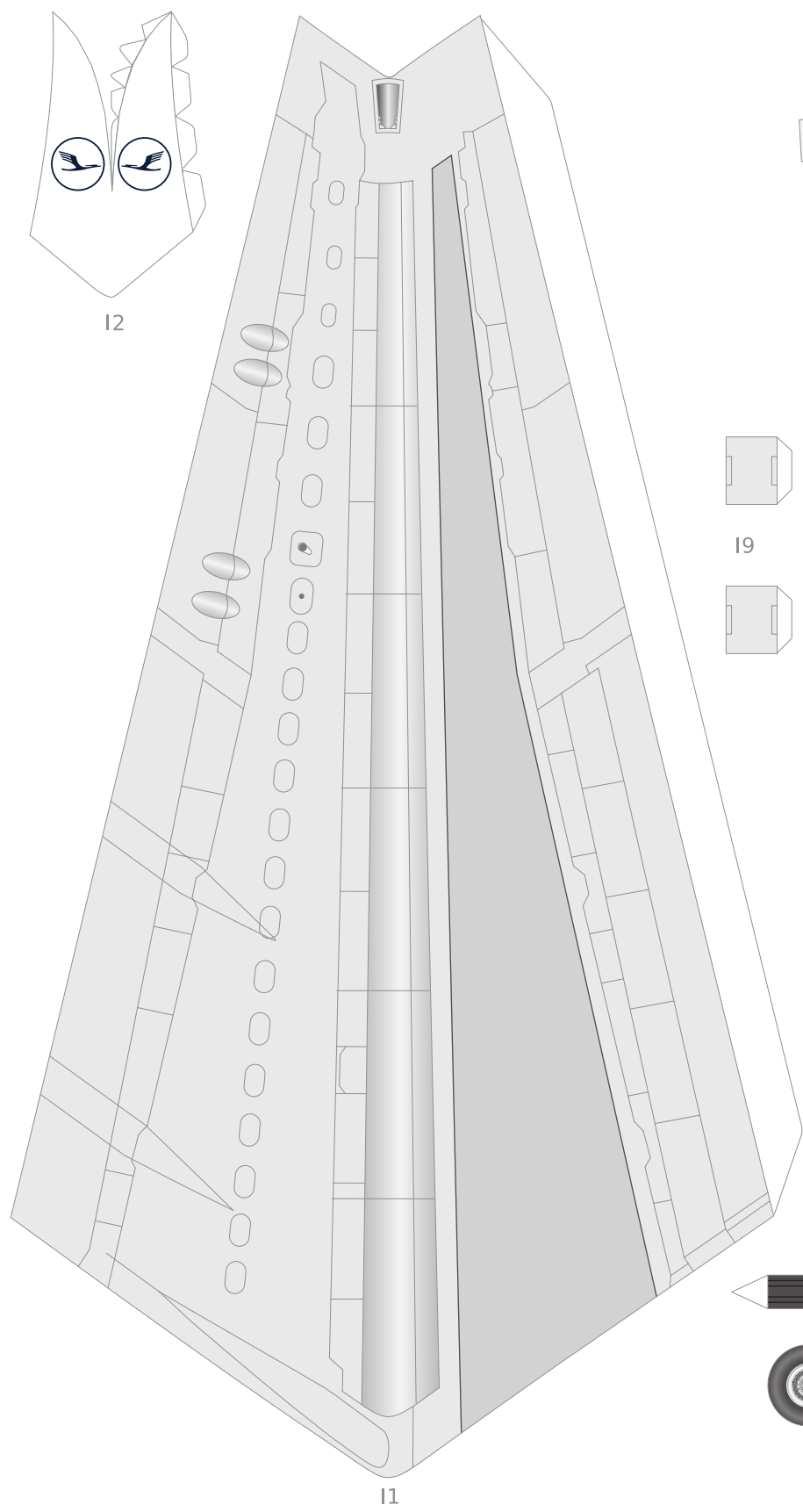

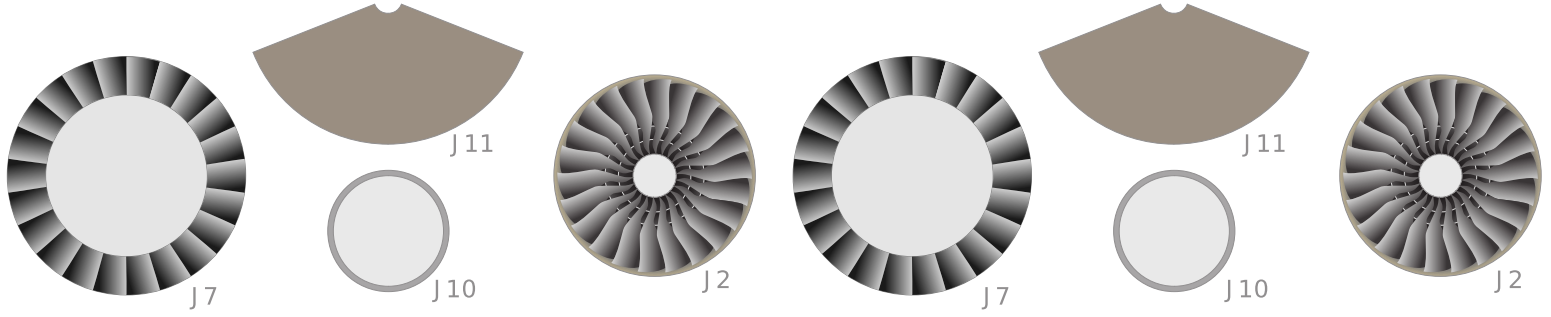
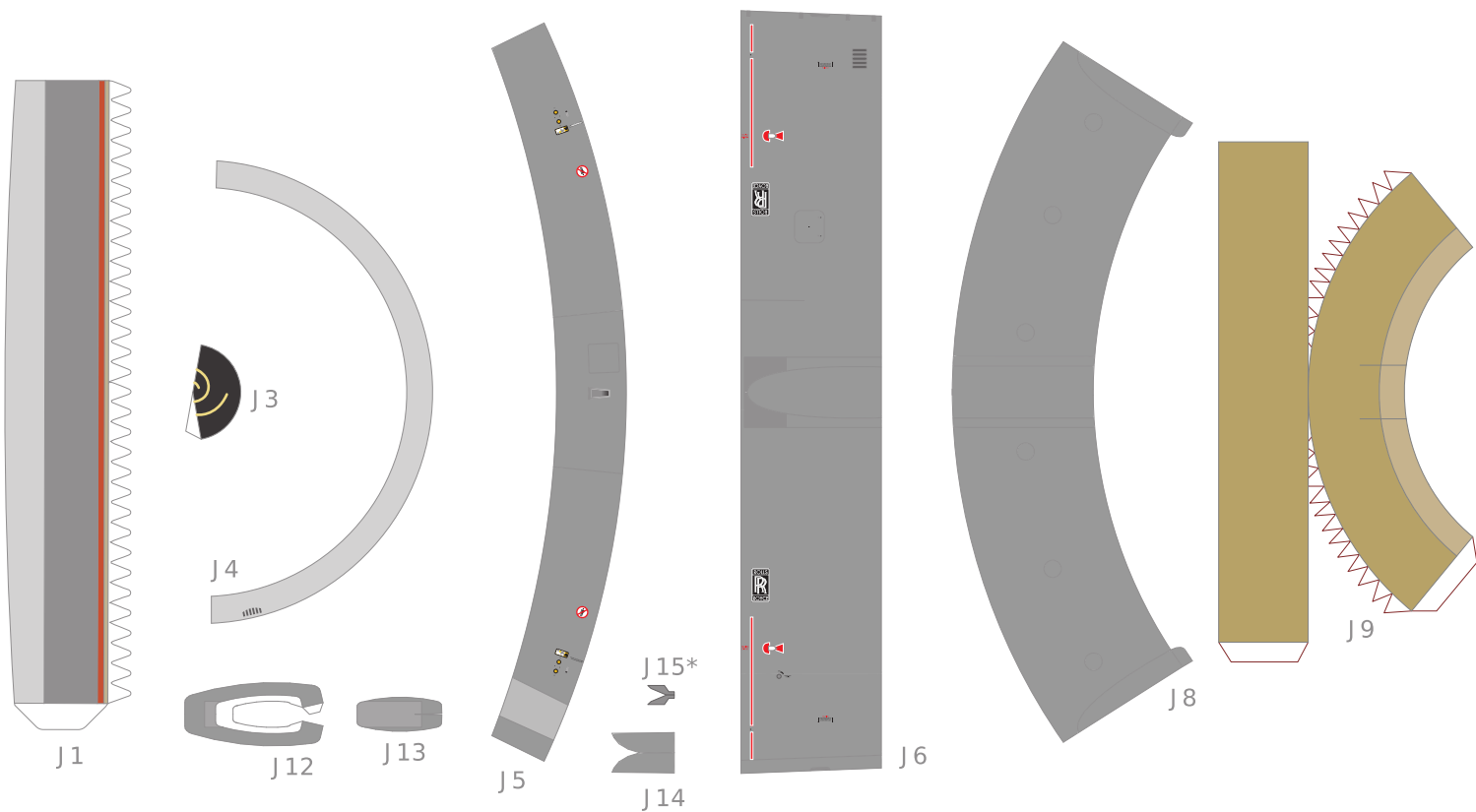
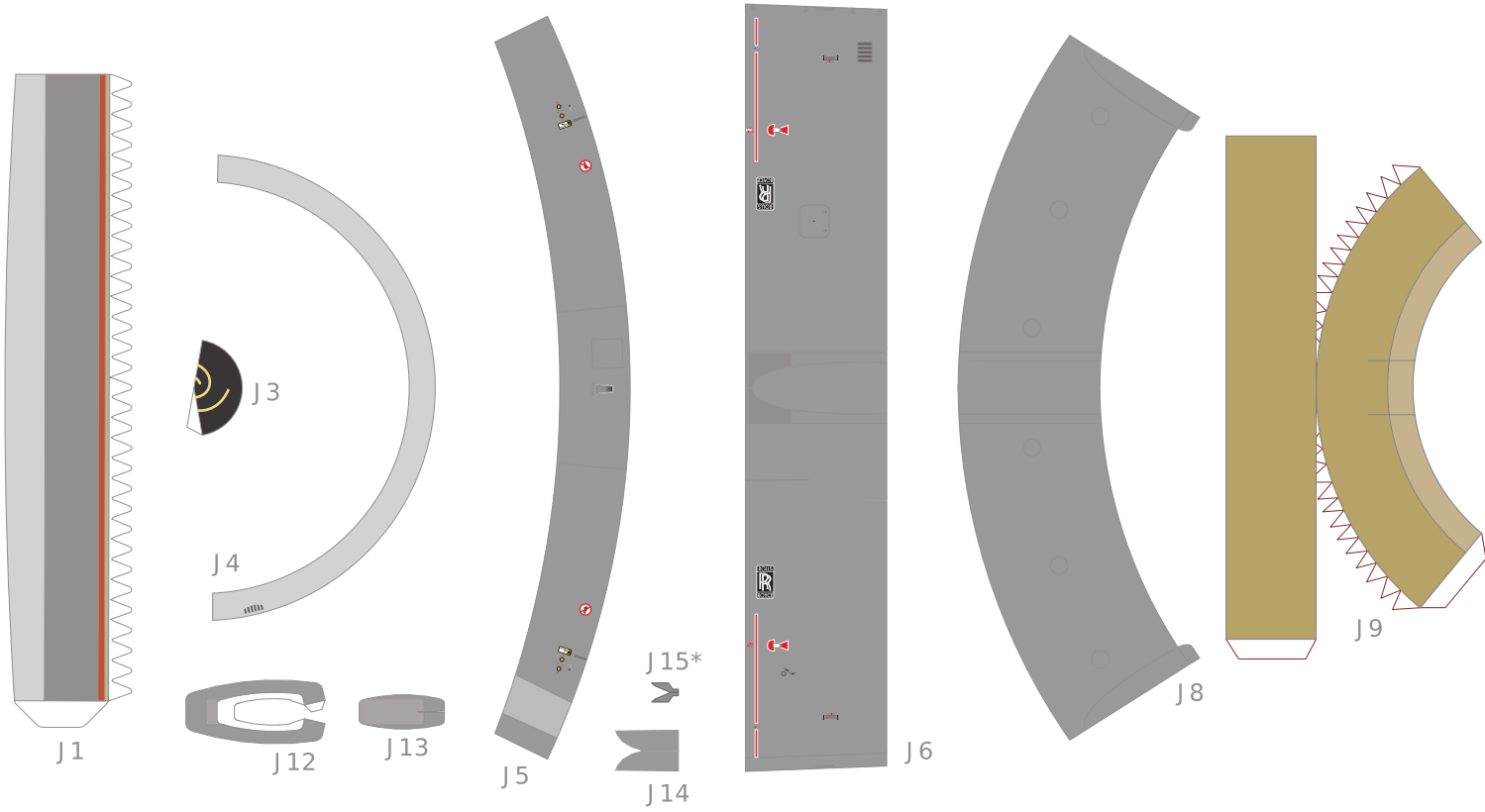

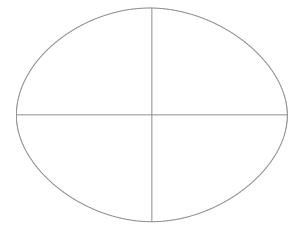
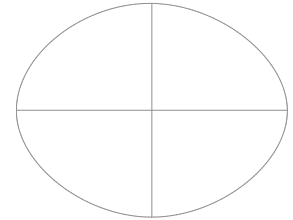
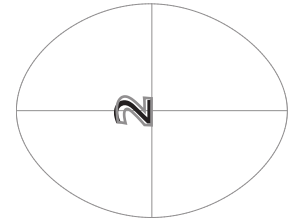

K2

K3

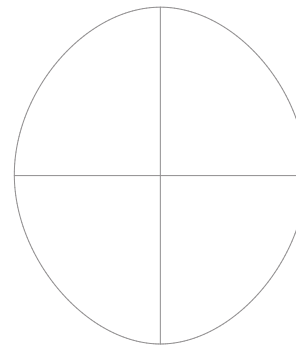
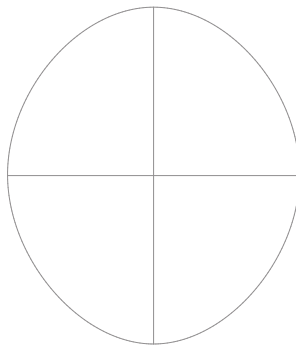
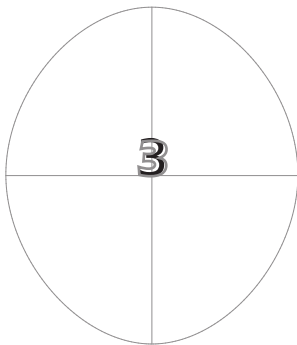

K4

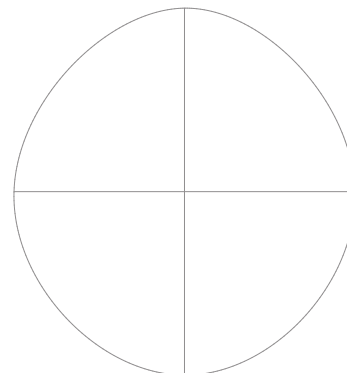
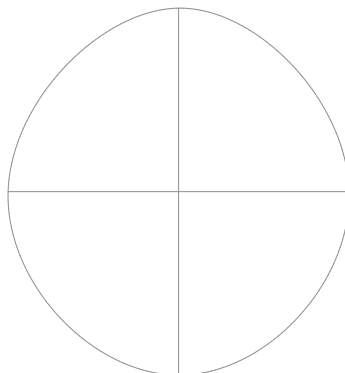
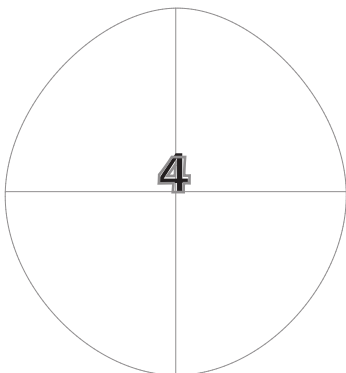

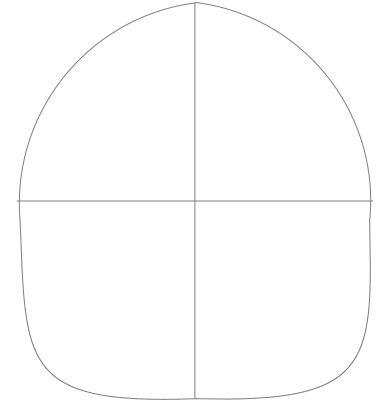
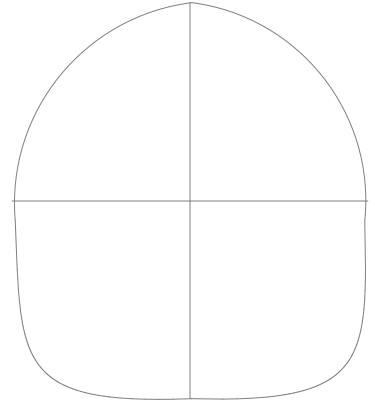
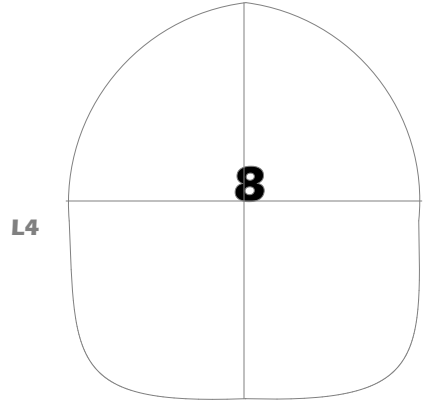
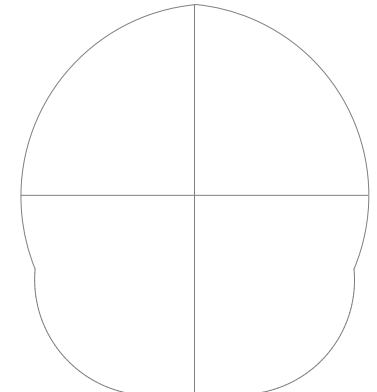
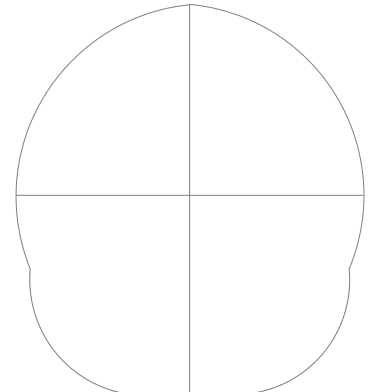
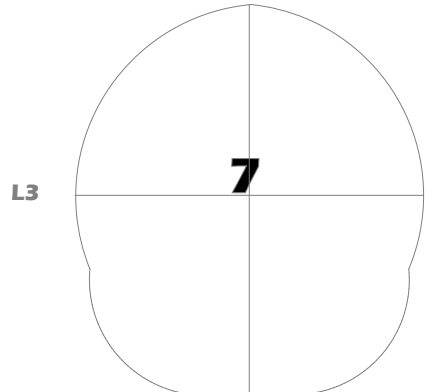
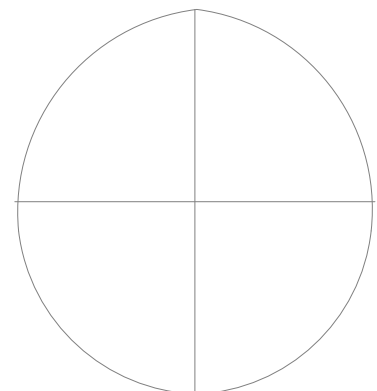
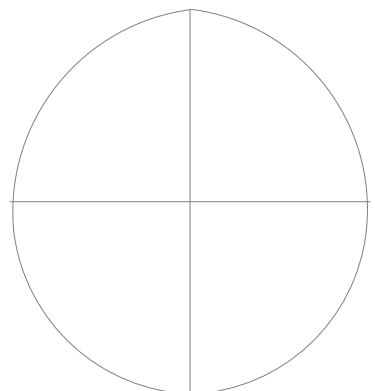
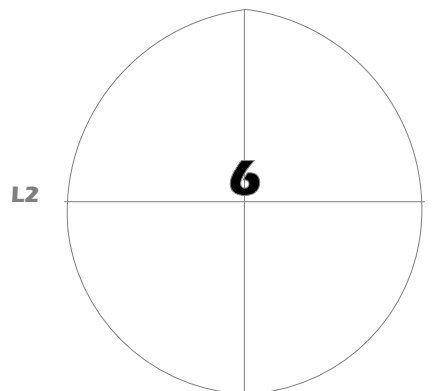
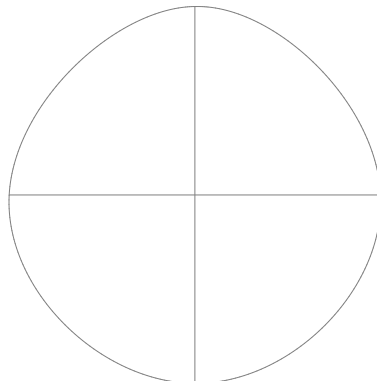
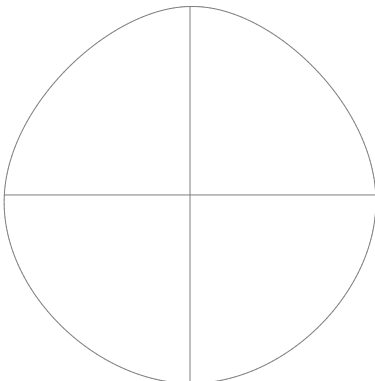
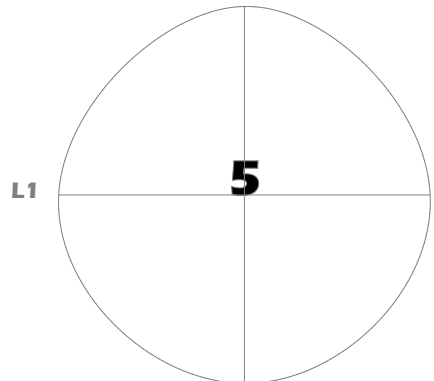

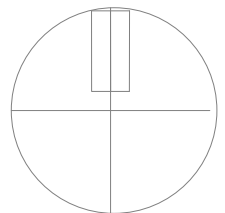
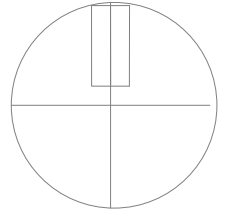
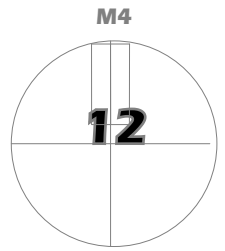
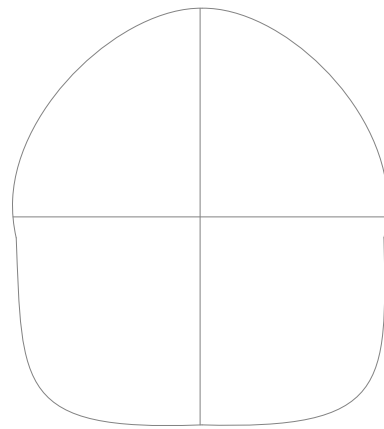
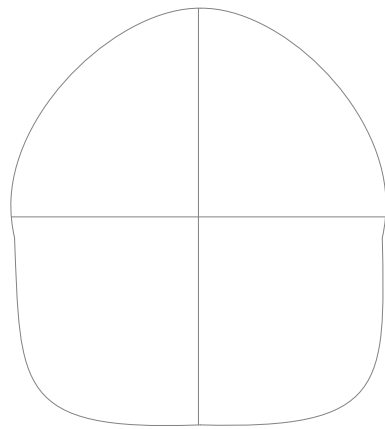
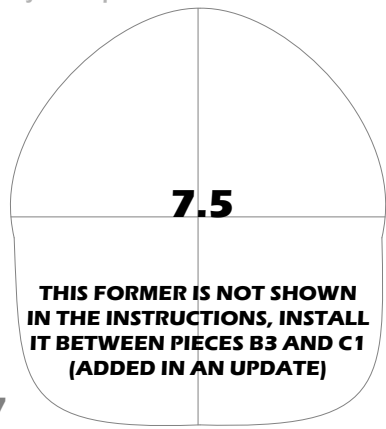

M7

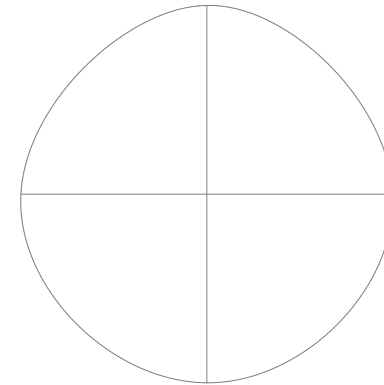
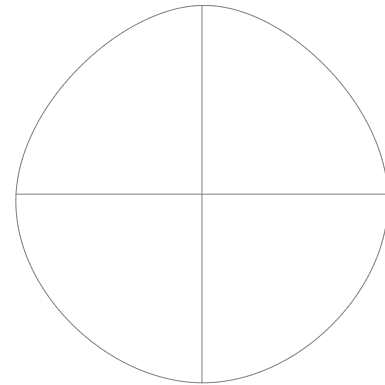
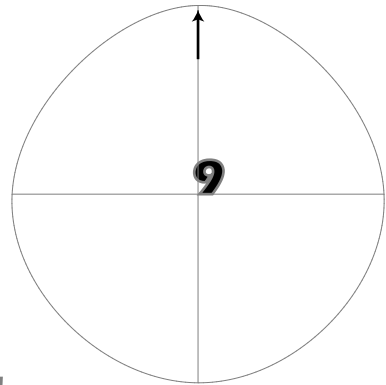

M1

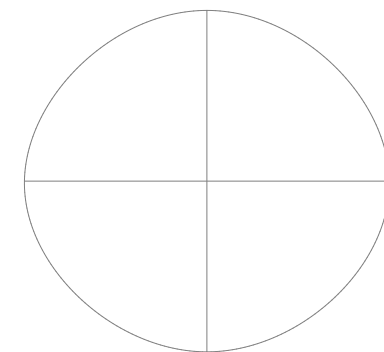
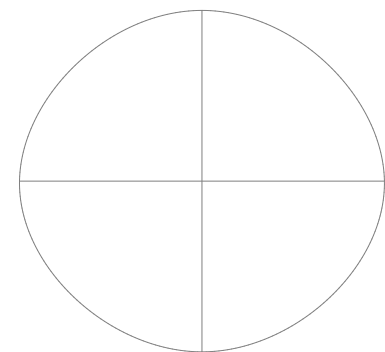
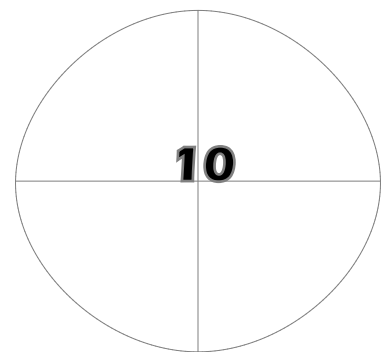

M2

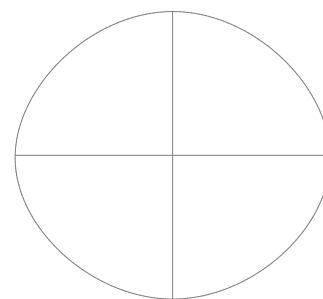
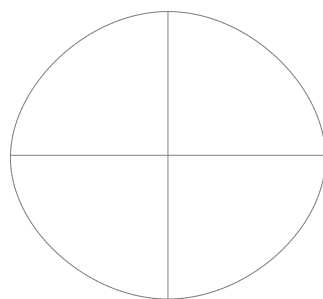
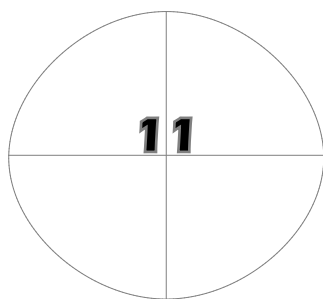

M3

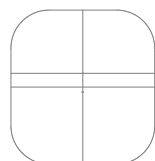
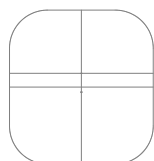
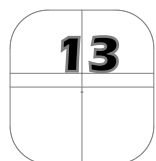

M5

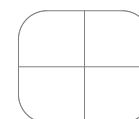
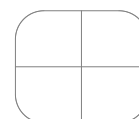

M6

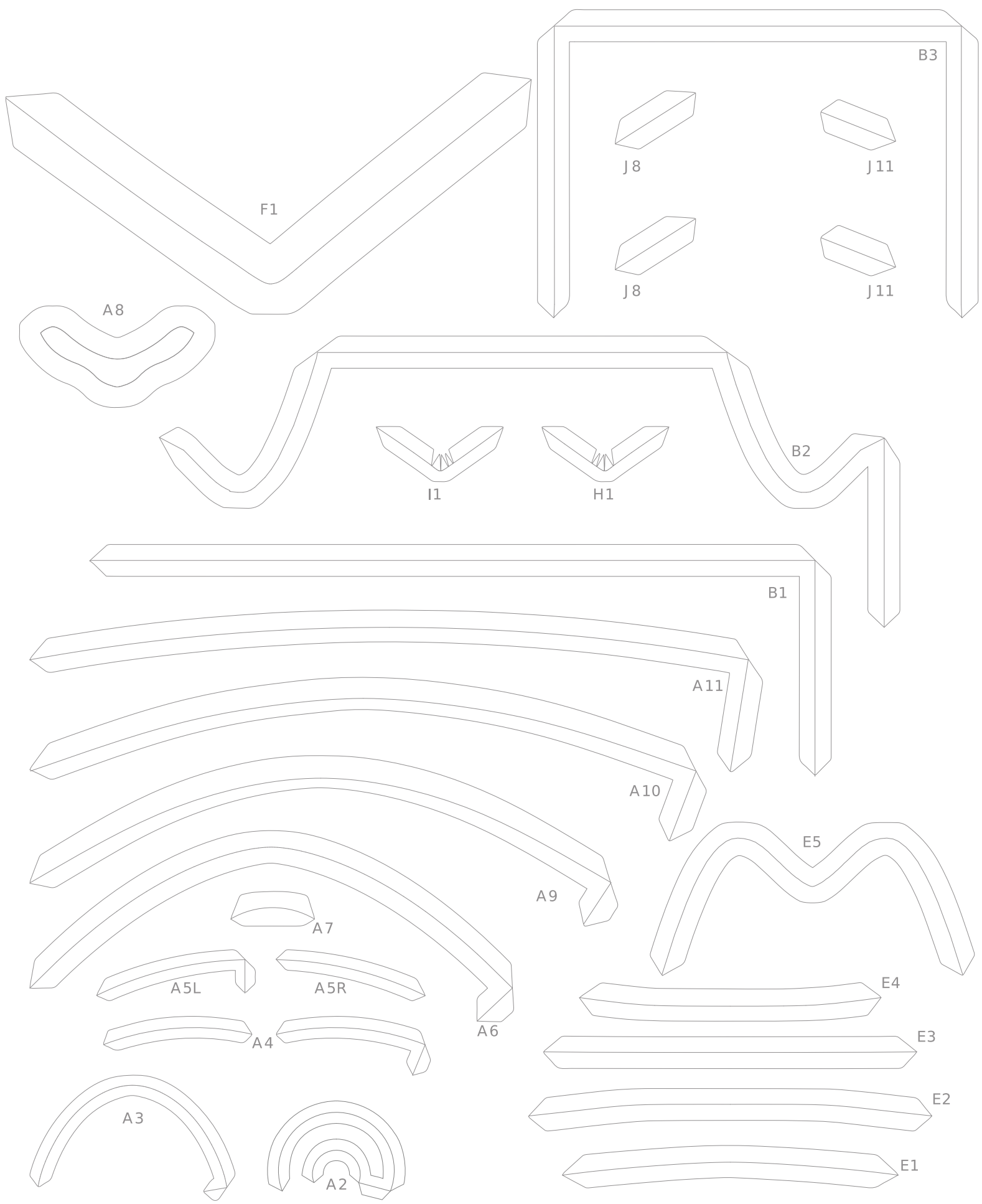

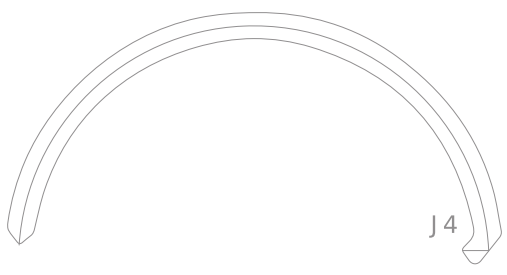
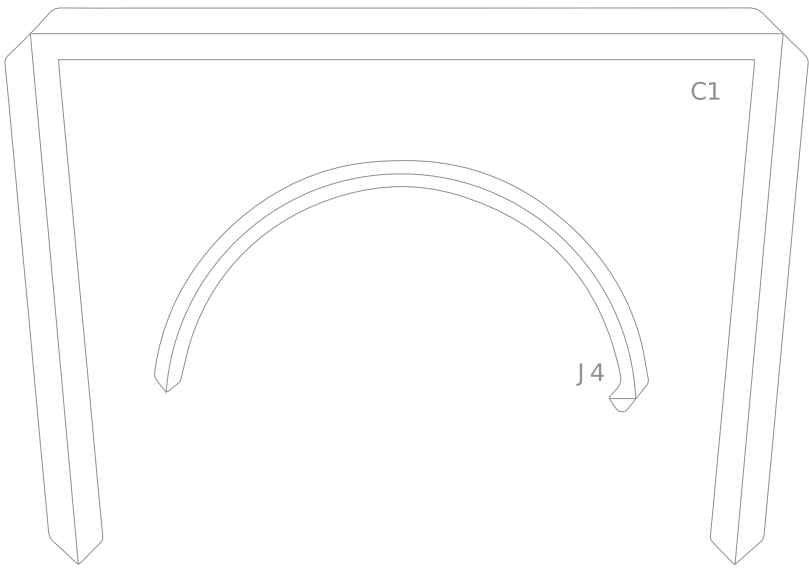
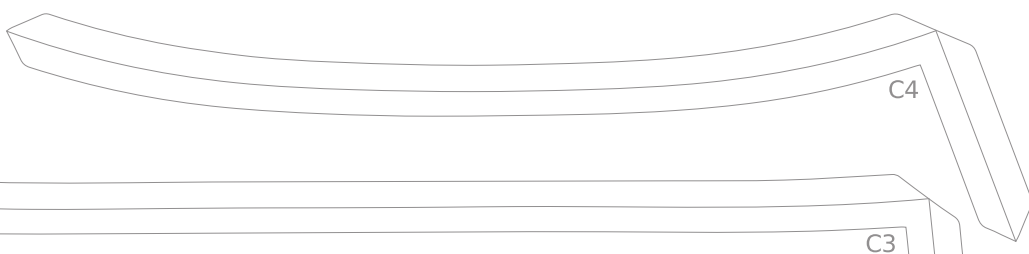
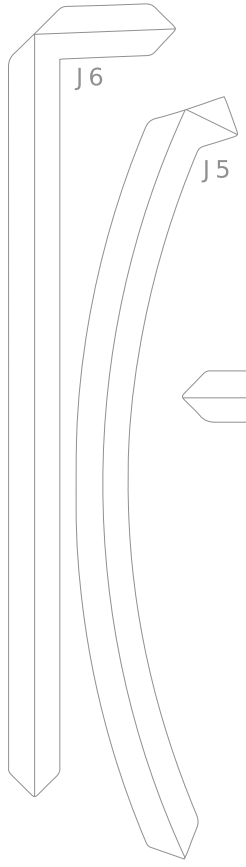
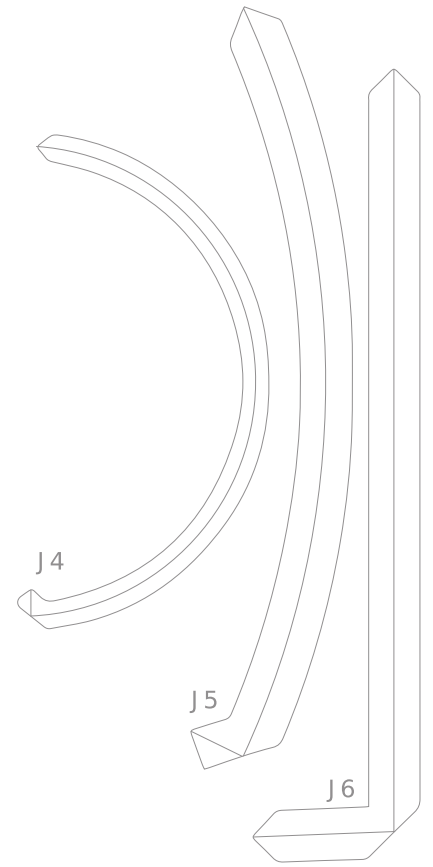
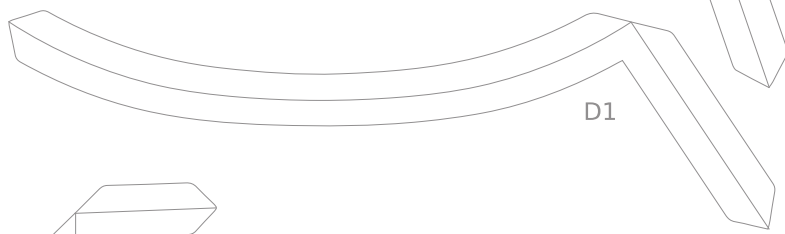
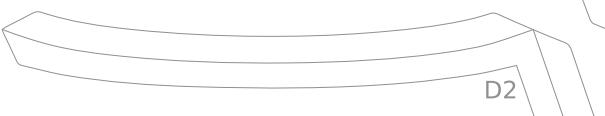
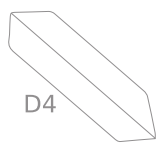
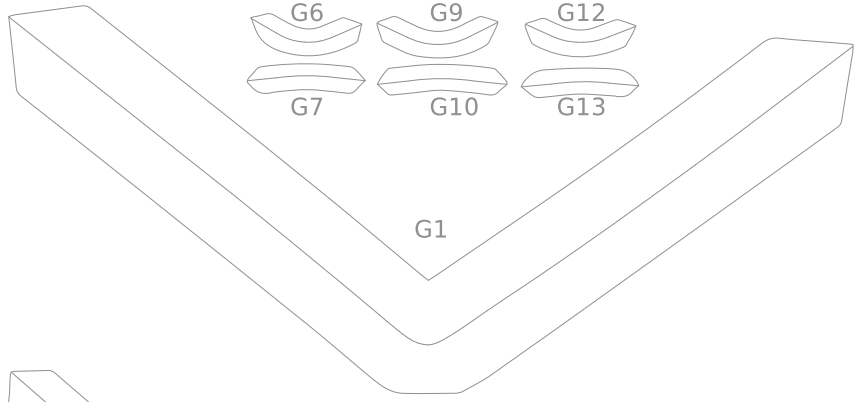
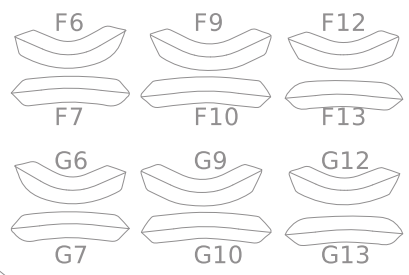

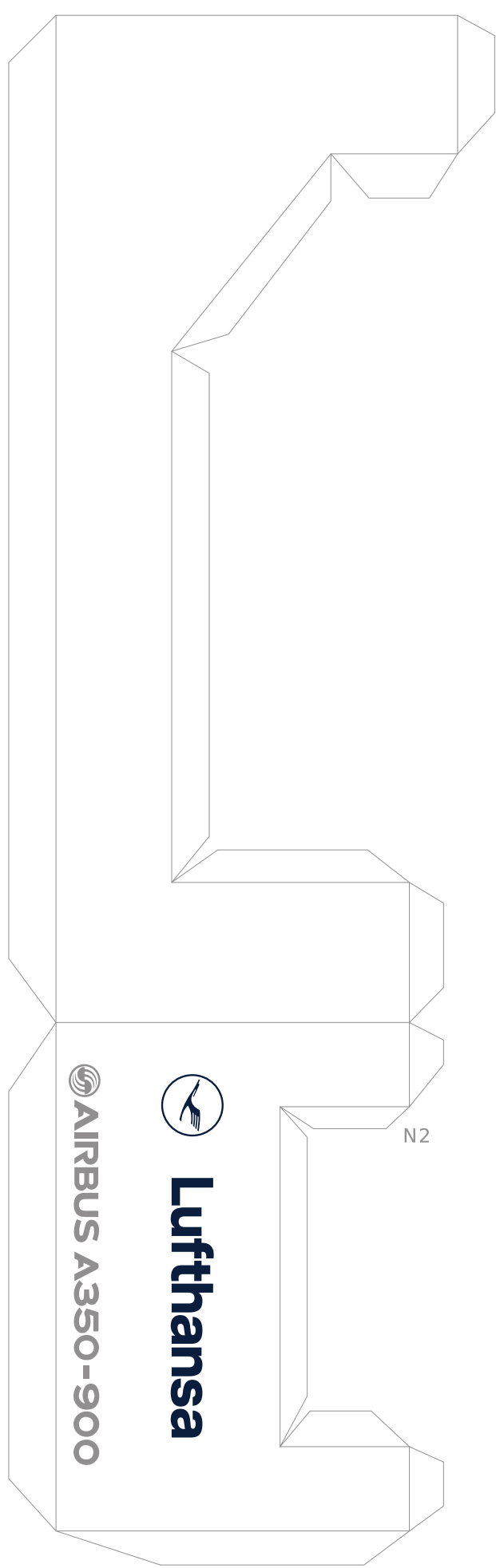
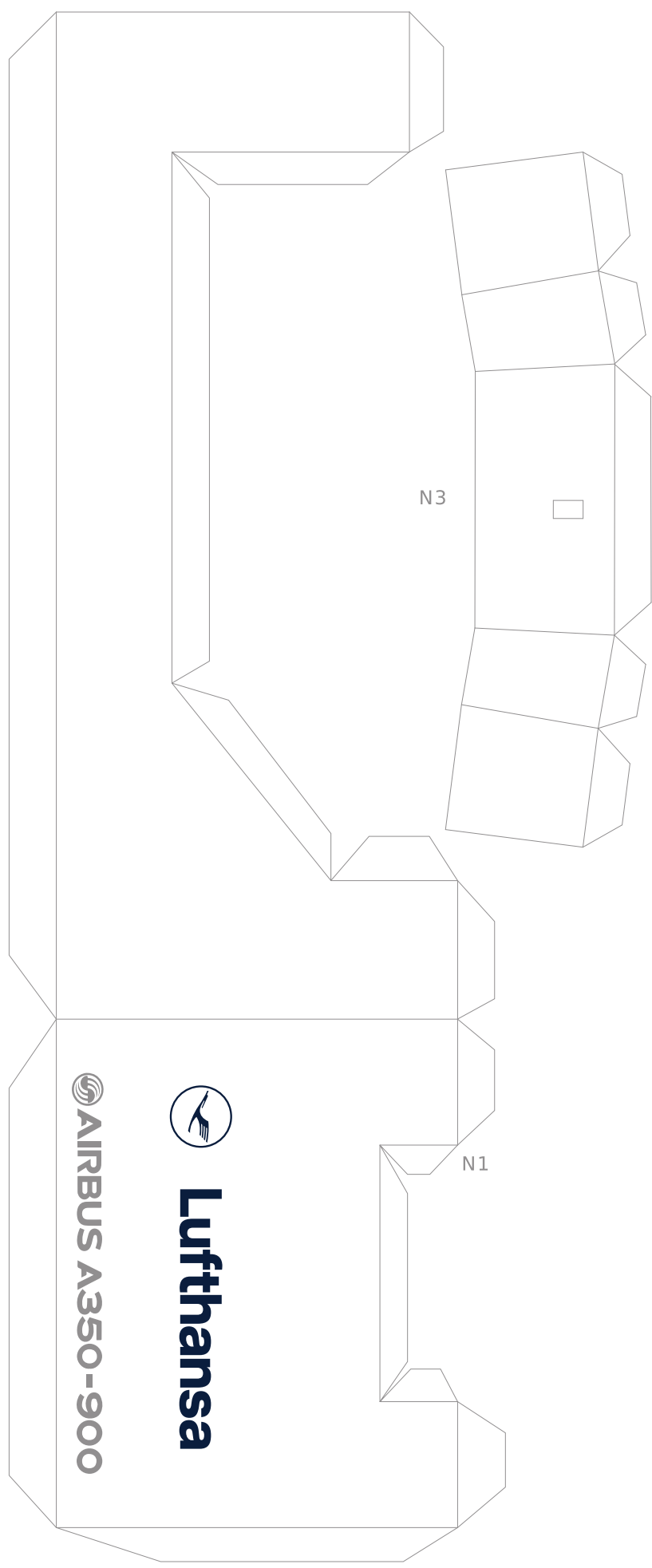

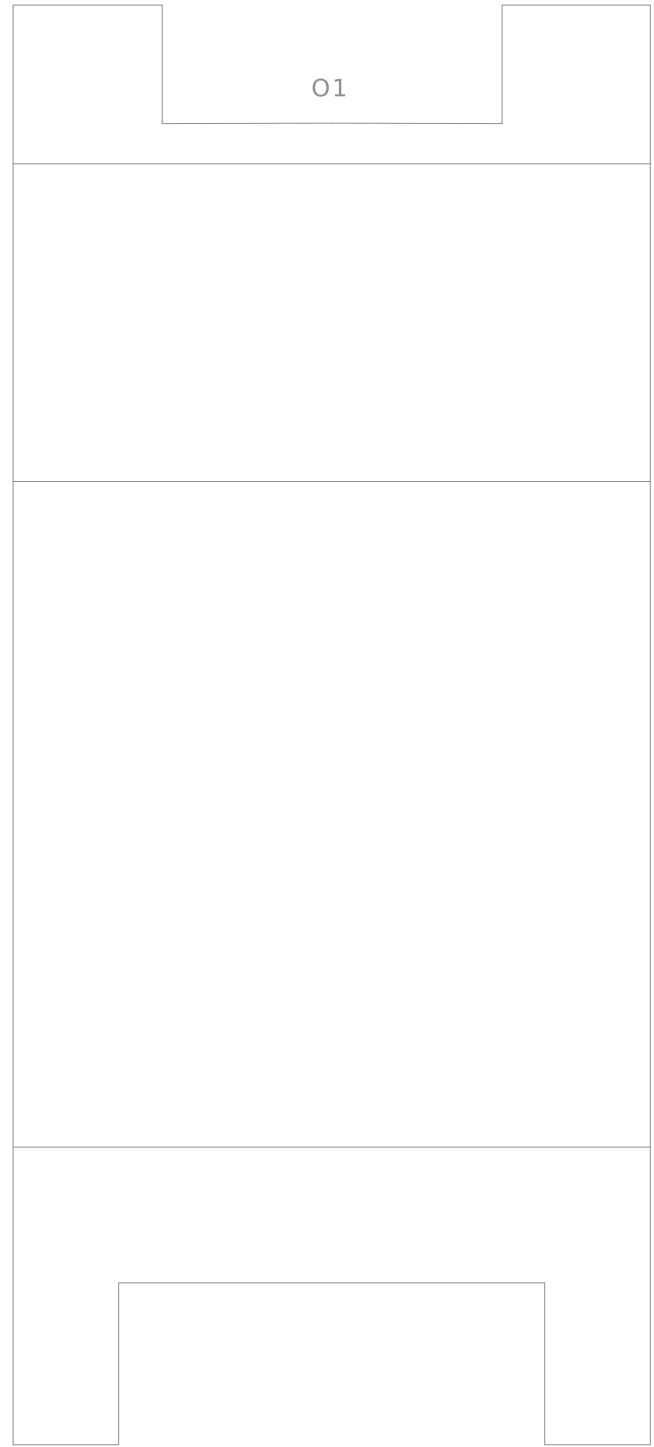

O3

ORIGINAL MODEL DESIGNED BY EDWIN RODRIGUEZ



PLEASE DO NOT SELL THIS FILE | DESIGNED IN PALMARES, COSTA RICA