

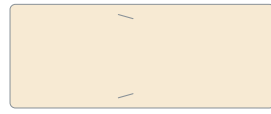

A13*

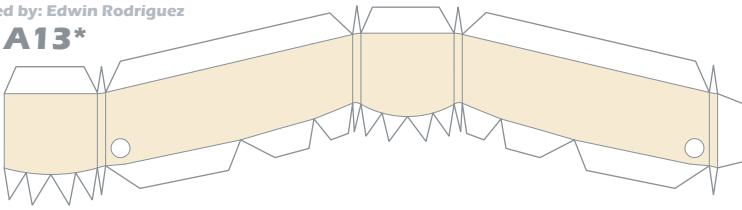

A14*

A18



A19



A20



A21



A22



A23



A24

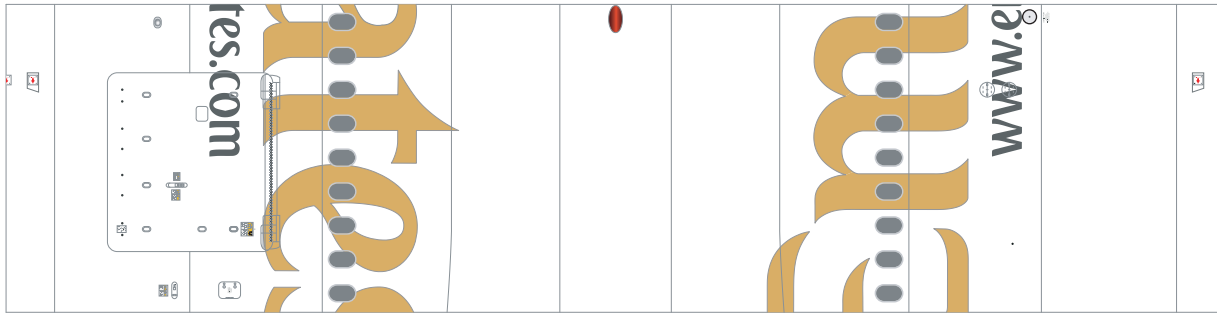

A12

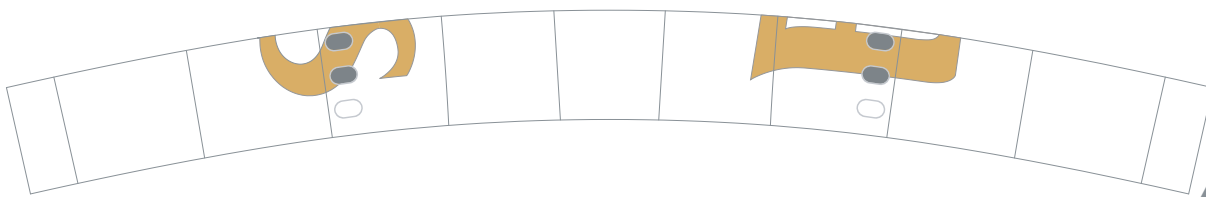

A11

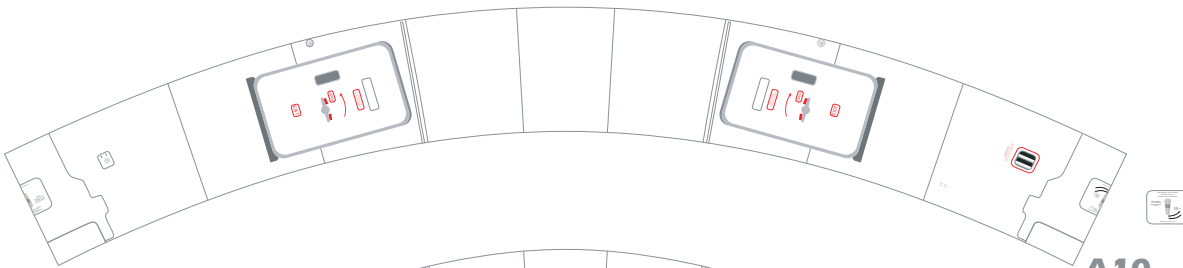

A10

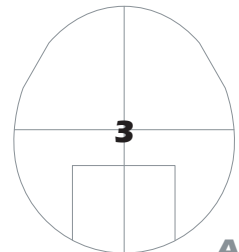
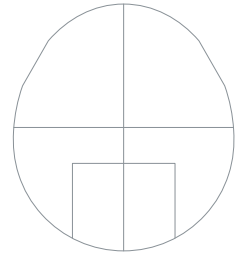
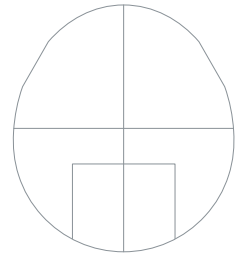

A17

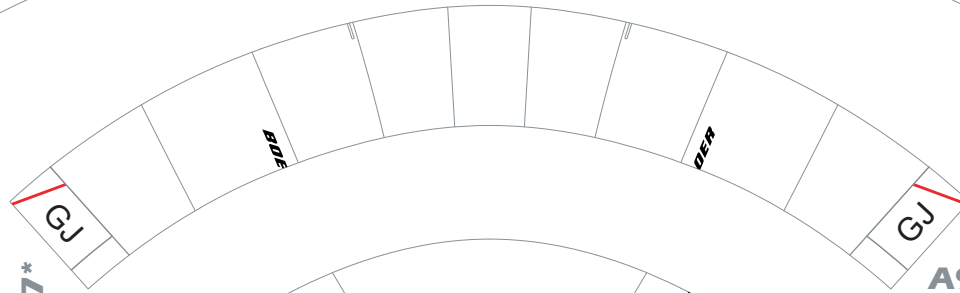

A9



A25*



A27*



A26*

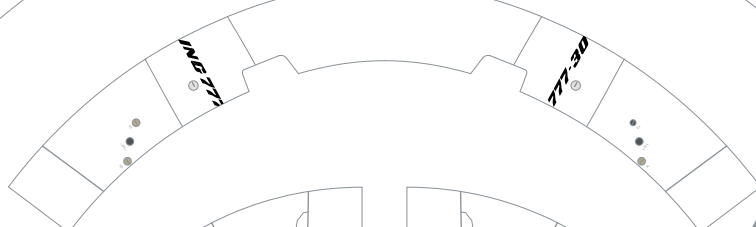

A8



A7R

A7L

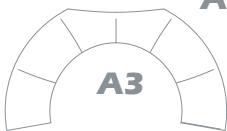

A3



A6

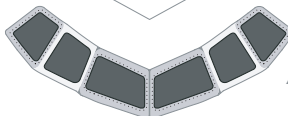

A5



A2



A1



A4

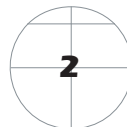

2

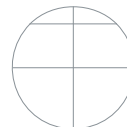

A16



1



A15



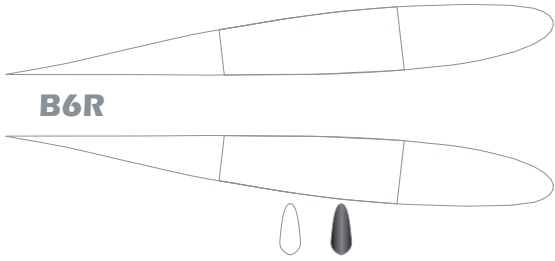

B6R

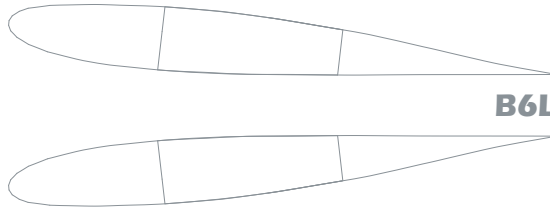

B6L

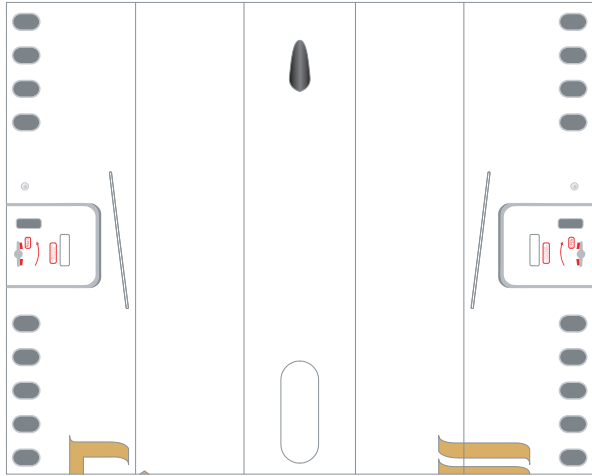

B3

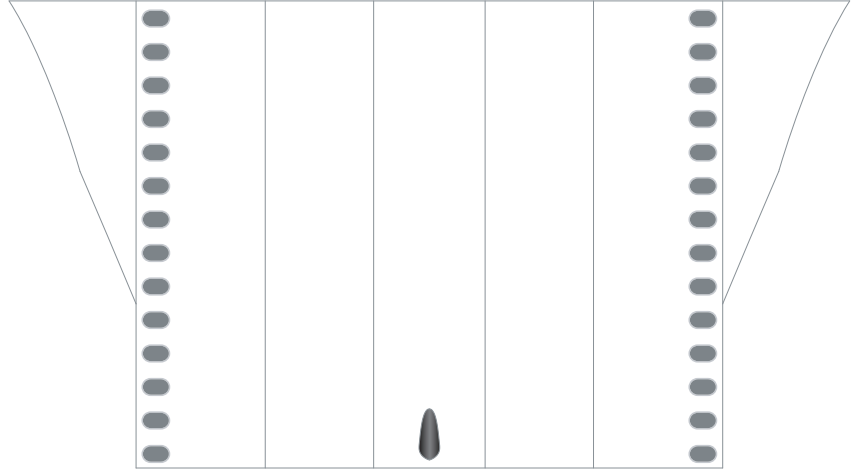

B4

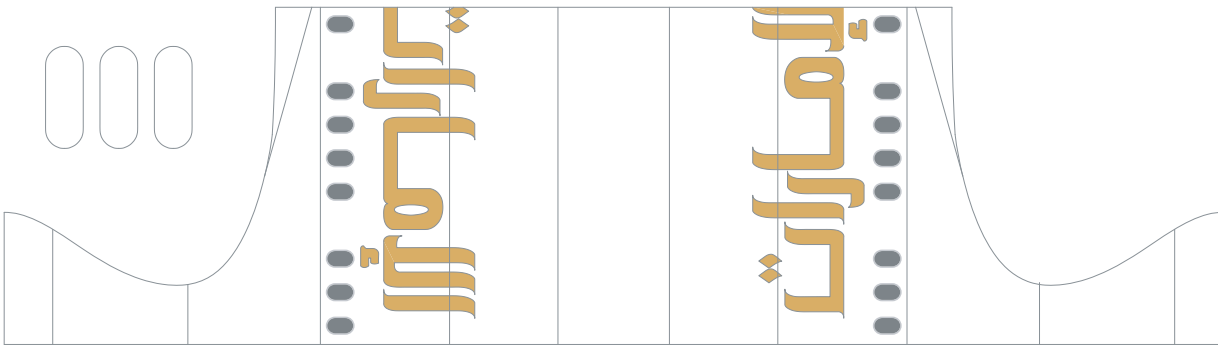

B2

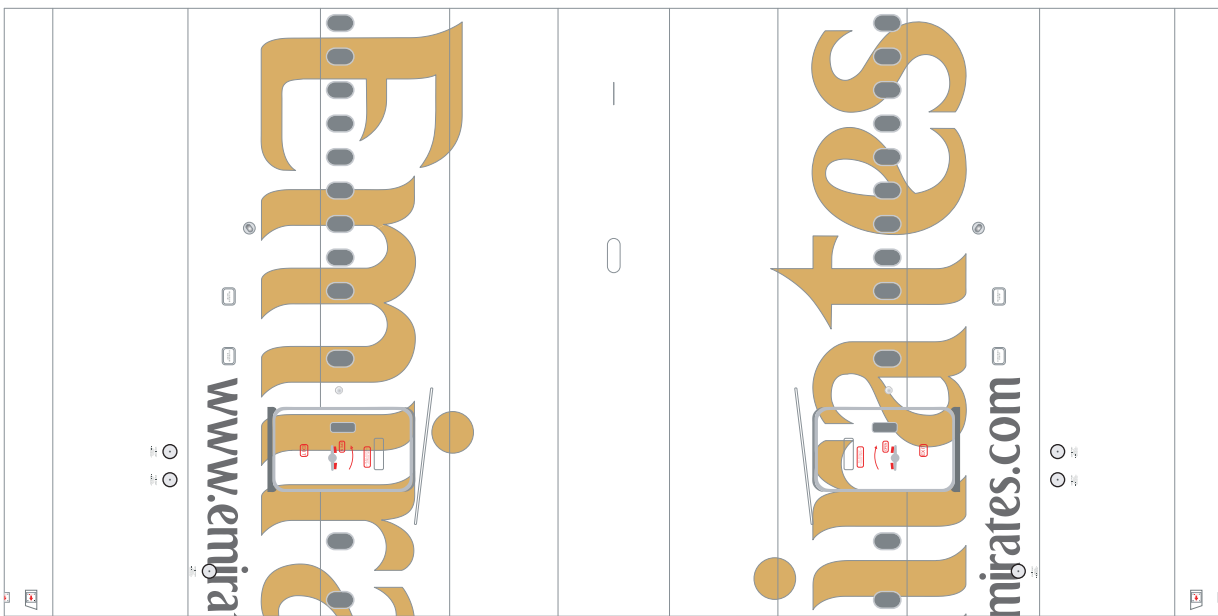

B1



B5

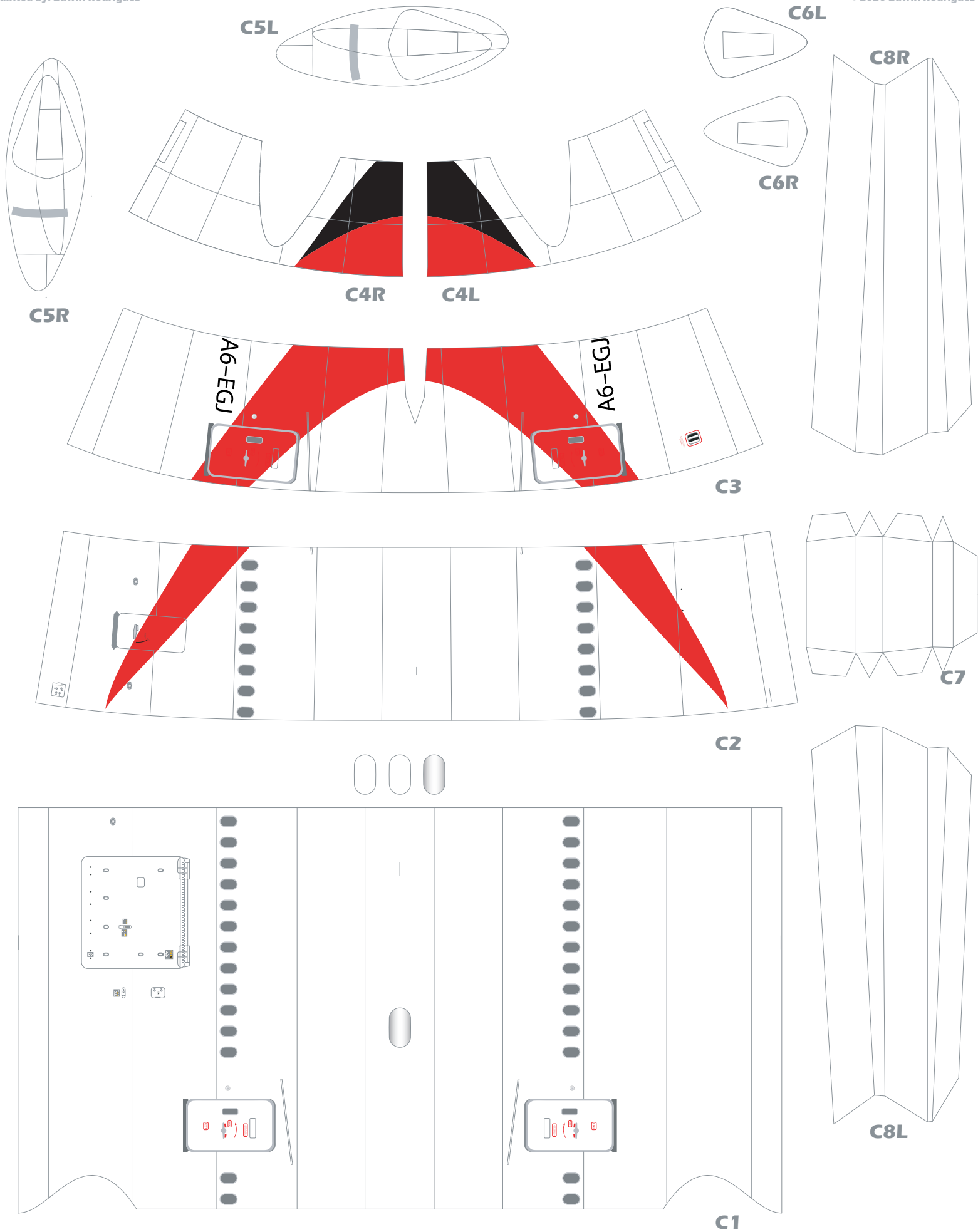



D14R* D14L*

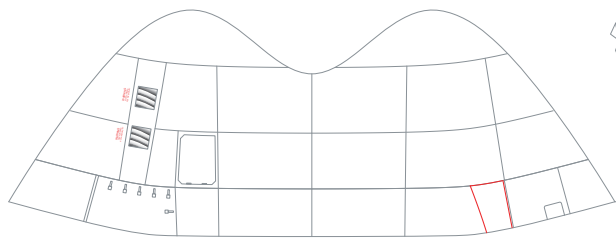
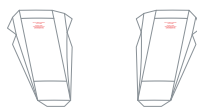

D5

D12L

D12R

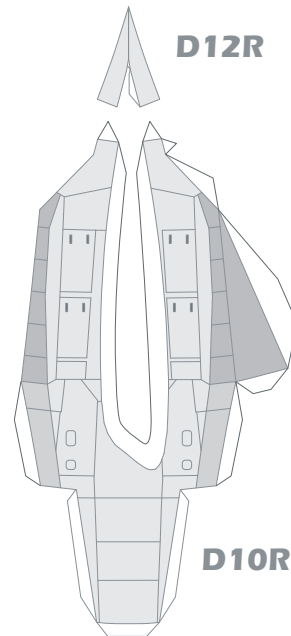
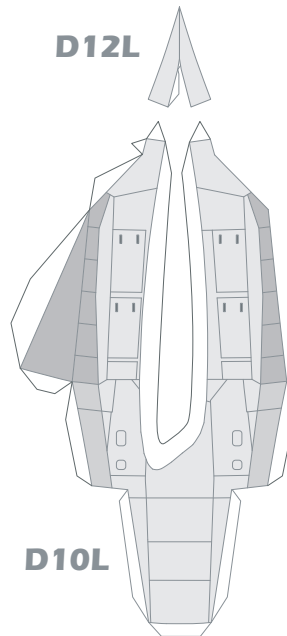

D10L

D10R

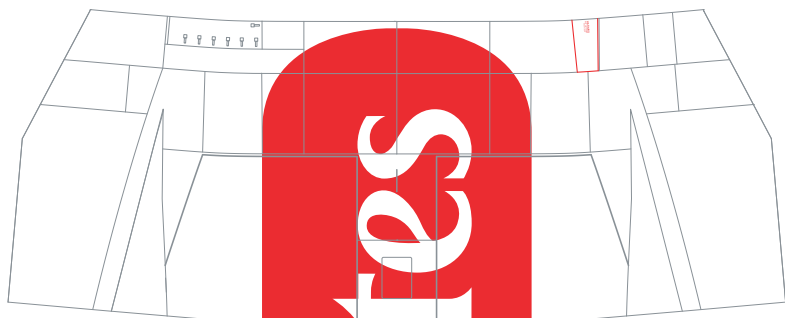

D4

D11L

D11R



D12*



D9

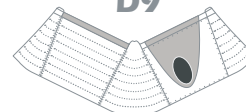

D13*

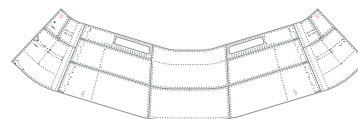

D8



D3

D15*

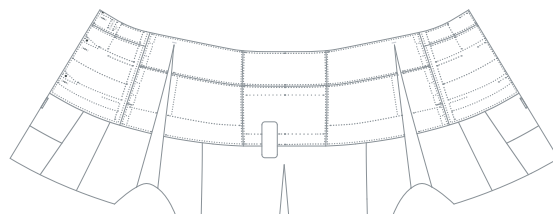

D7



D2

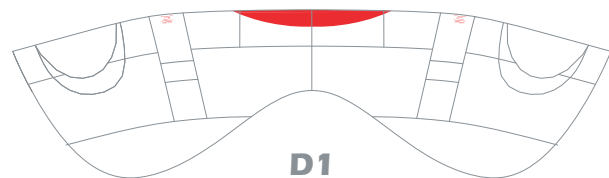

D1

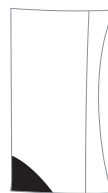

D6L



D6CL



D6CR

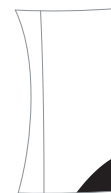

D6R

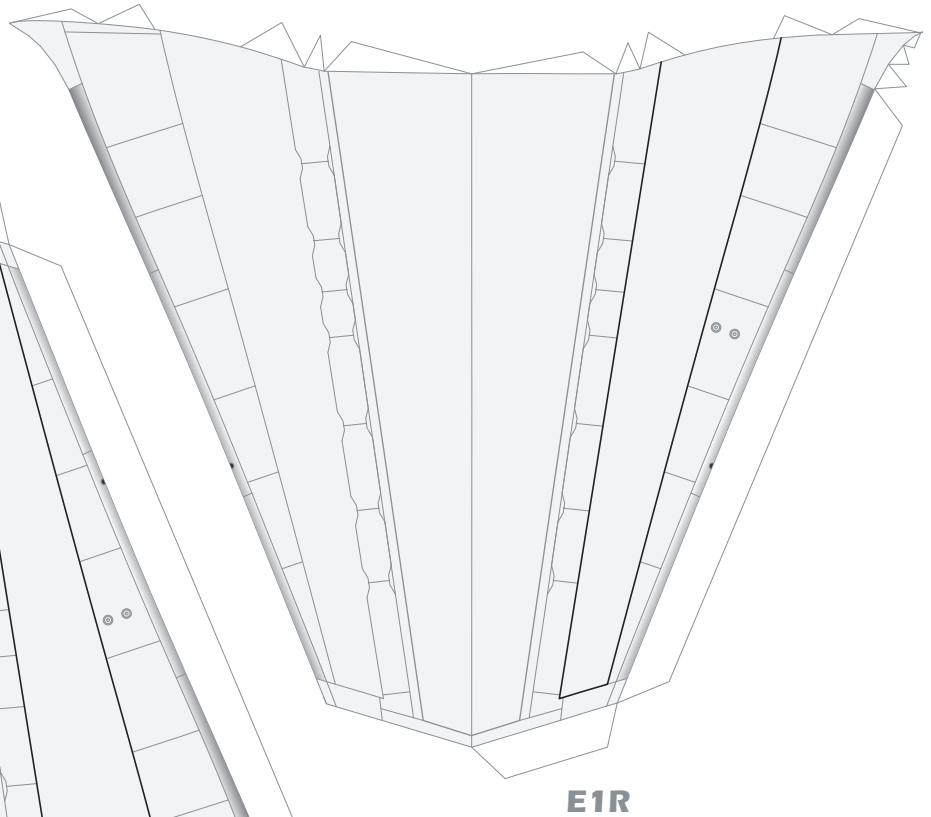
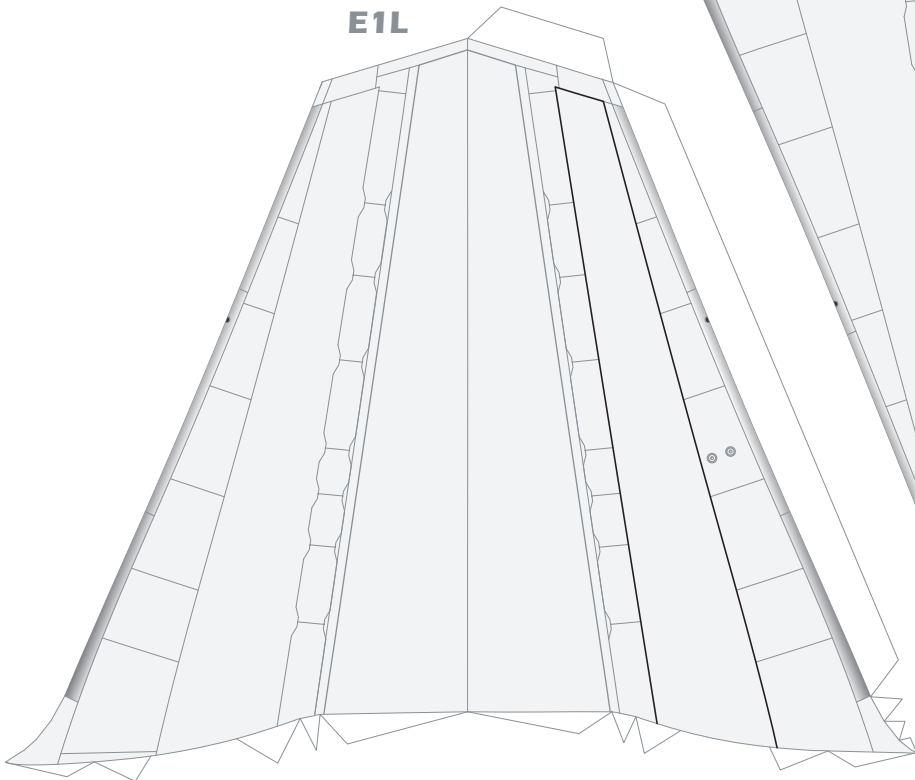
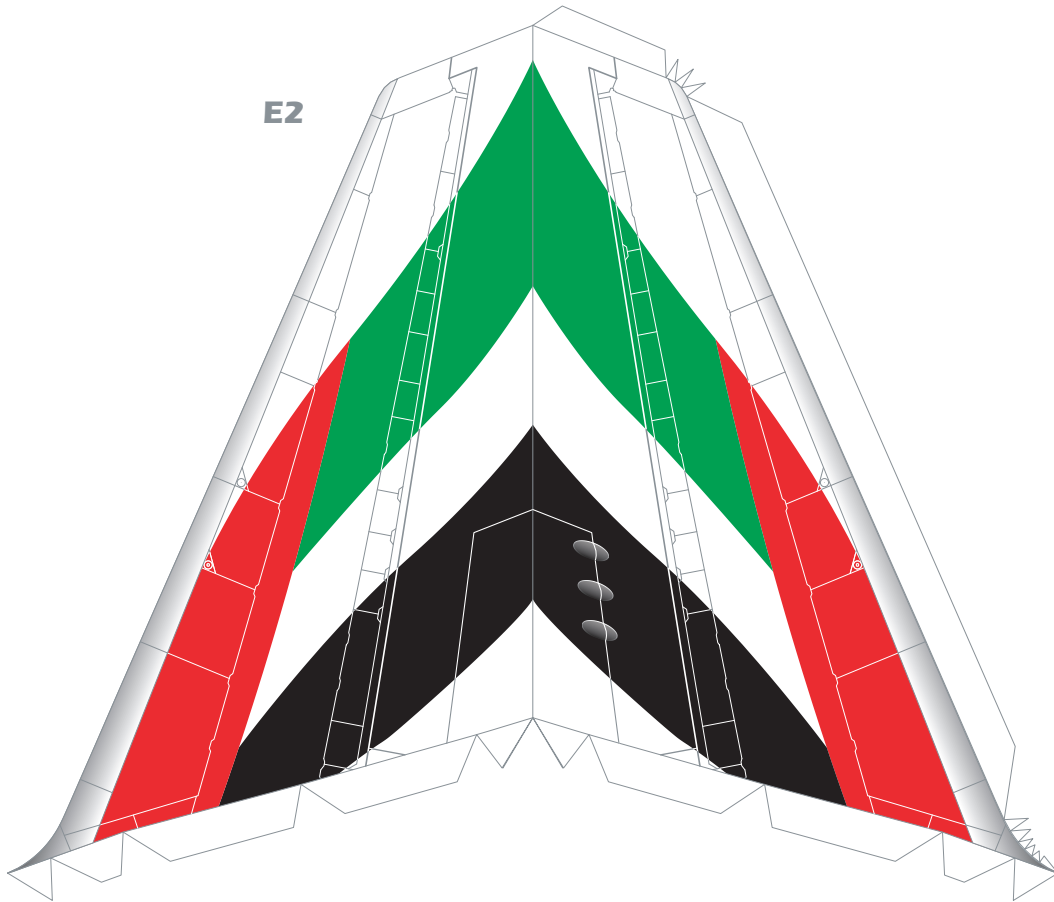

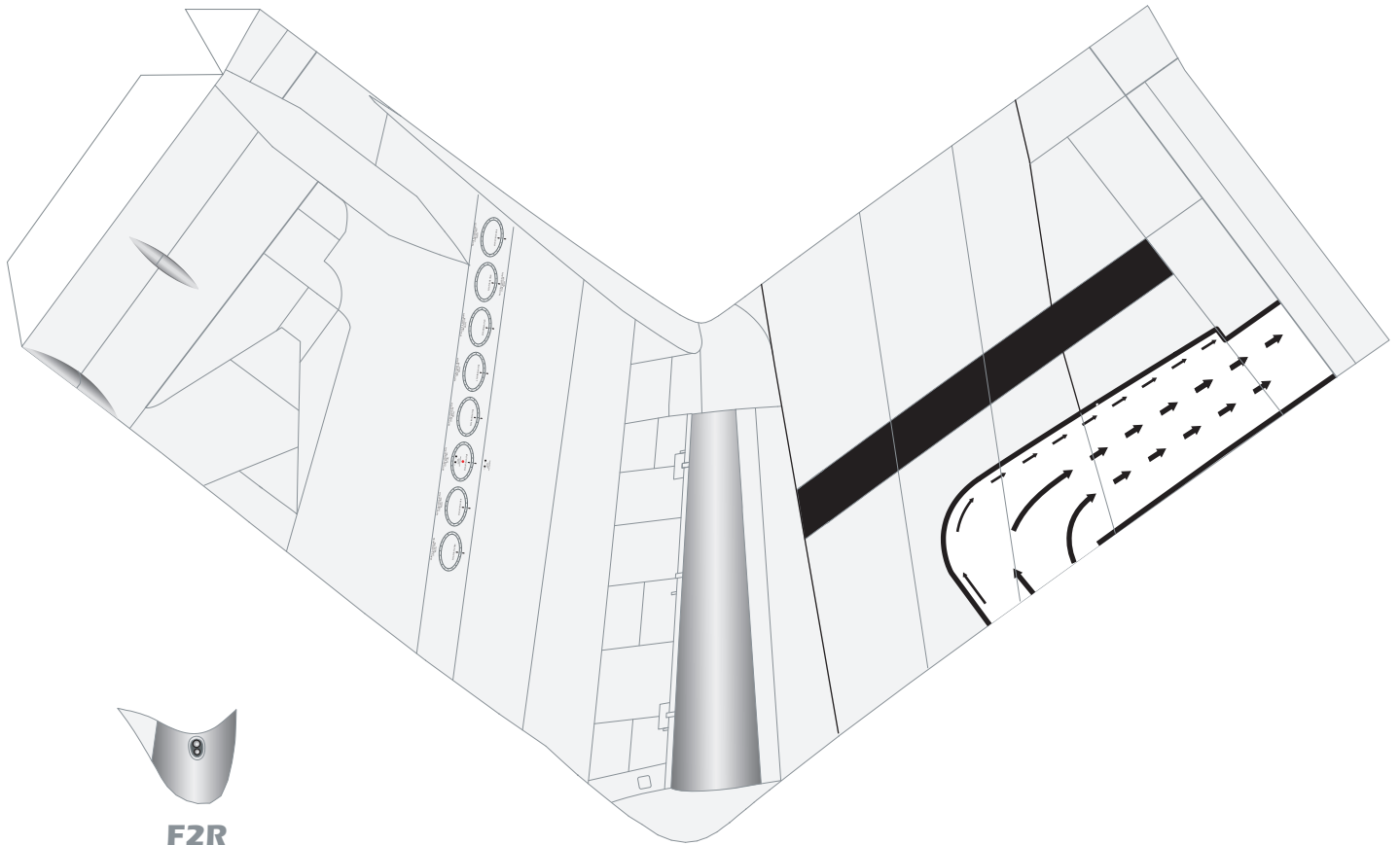

F2R

F1R

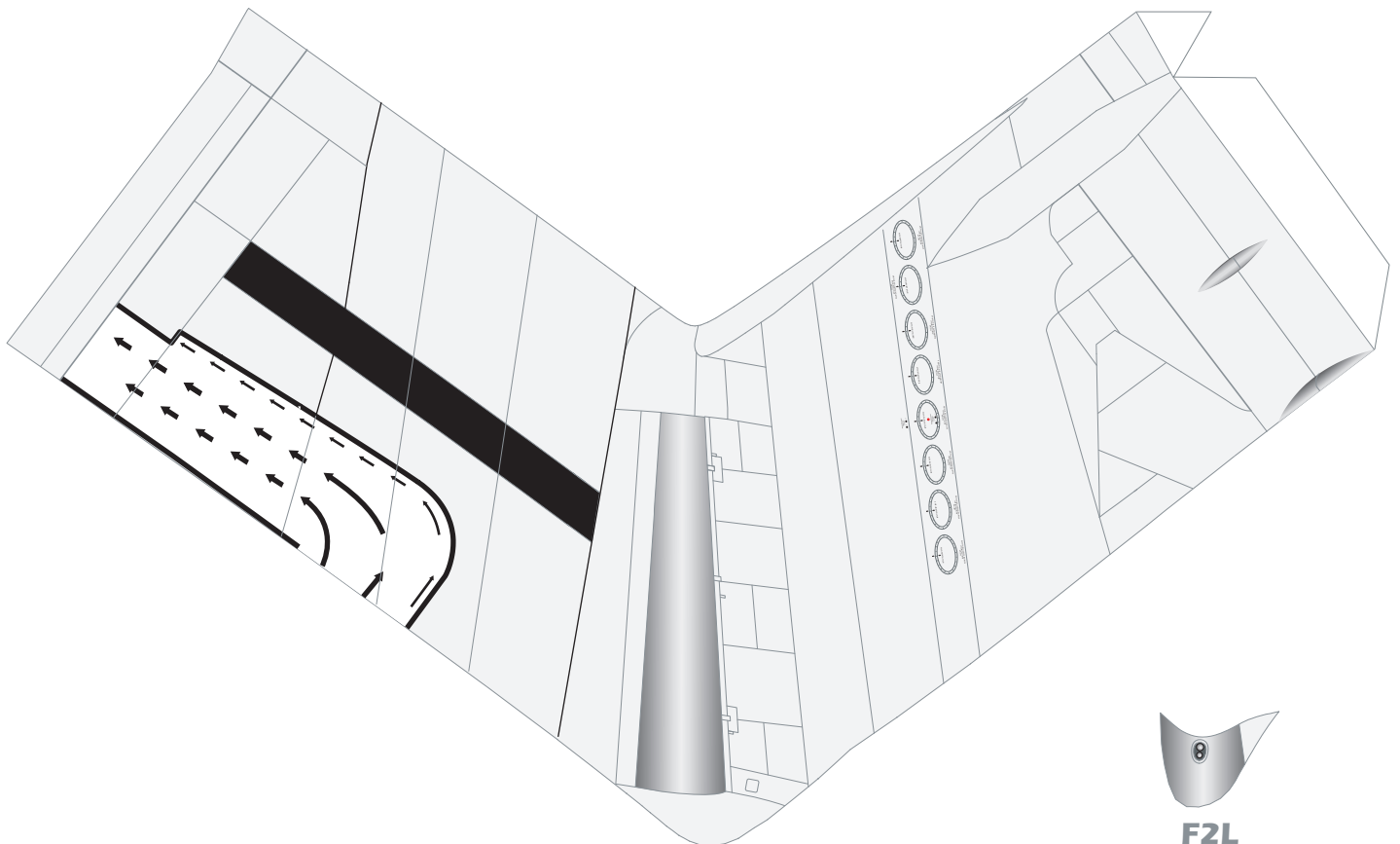

F2L

F1L

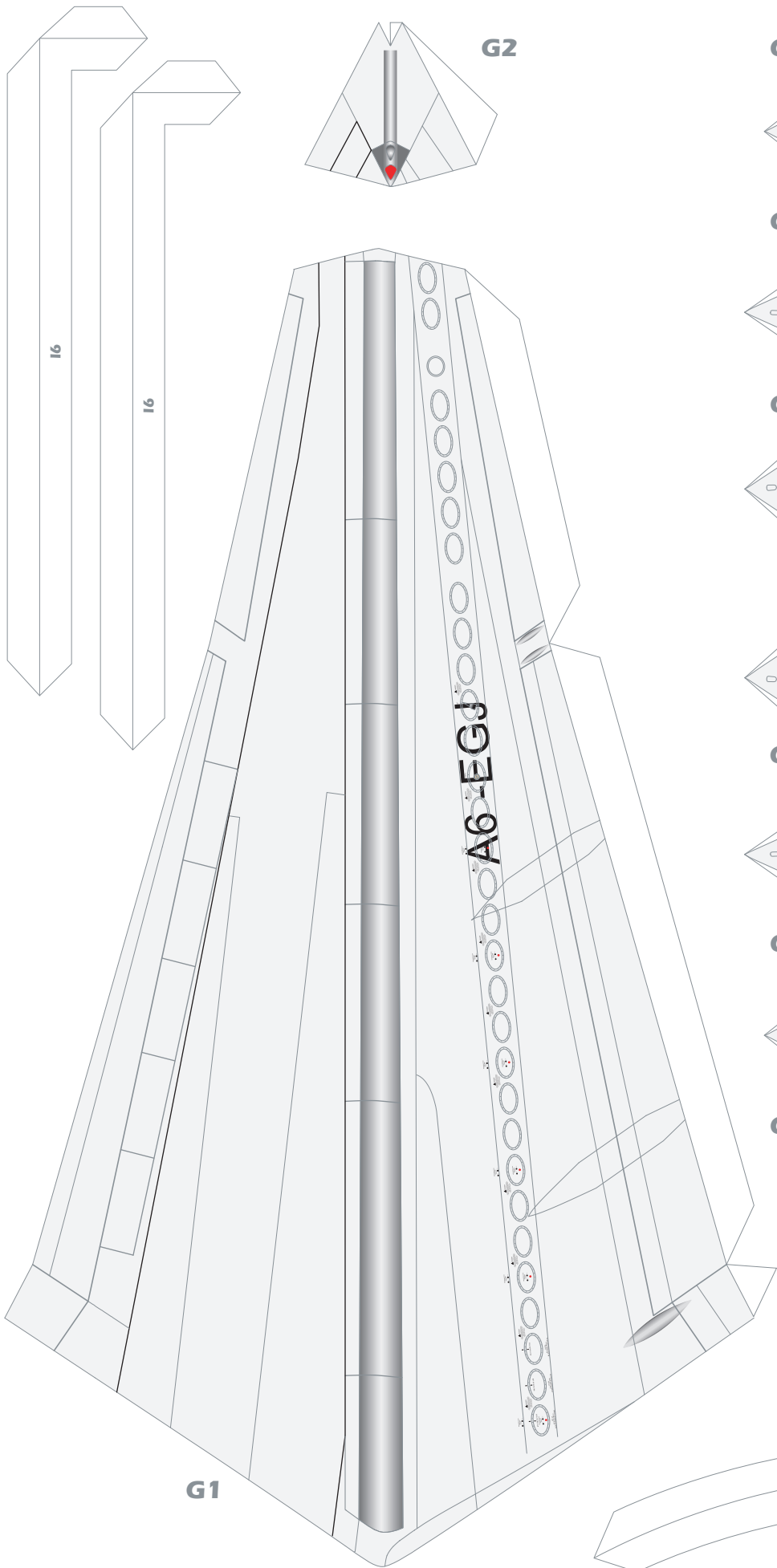

G2

G9R

G10R

G11R



G6R

G7R

G8R

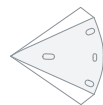

G3R

G4R

G5R

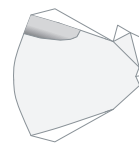
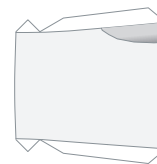

G3L

G4L

G5L

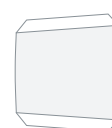

G6L

G7L

G8L

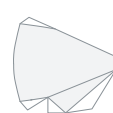

G9L

G10L

G11L



G1

14

15

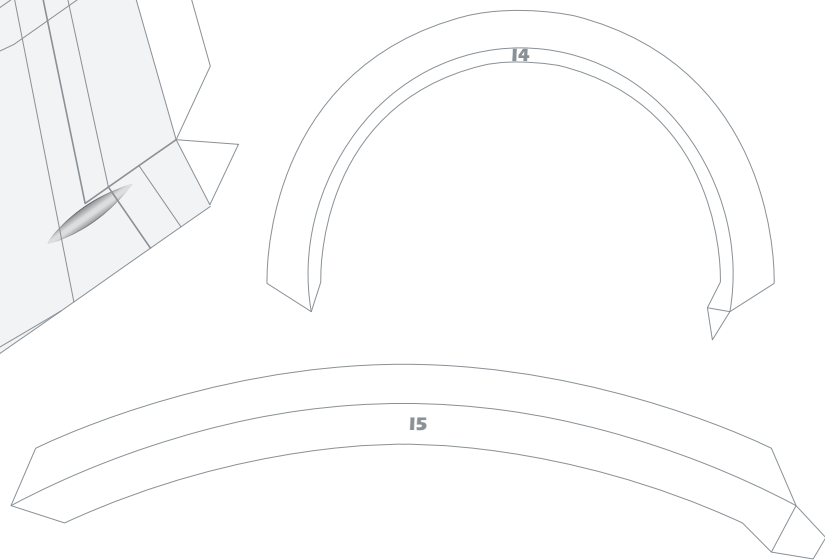

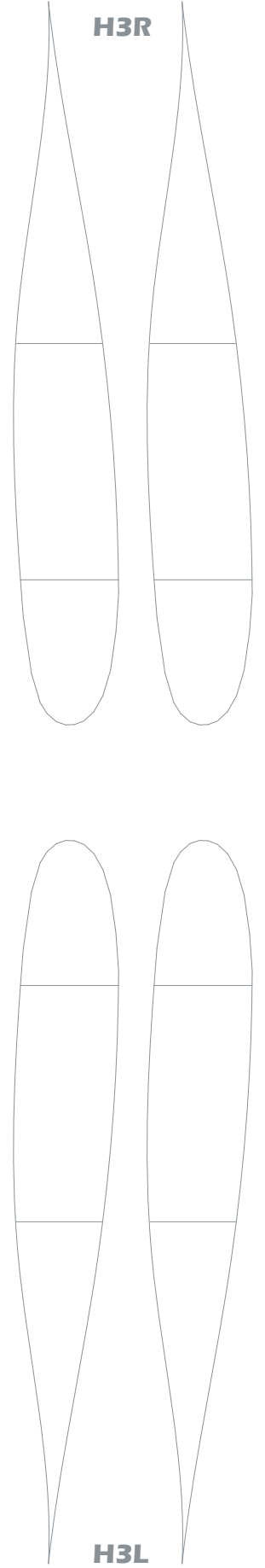
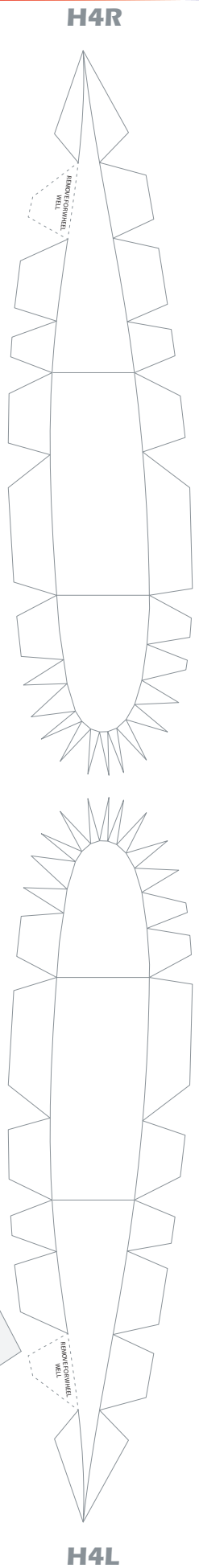
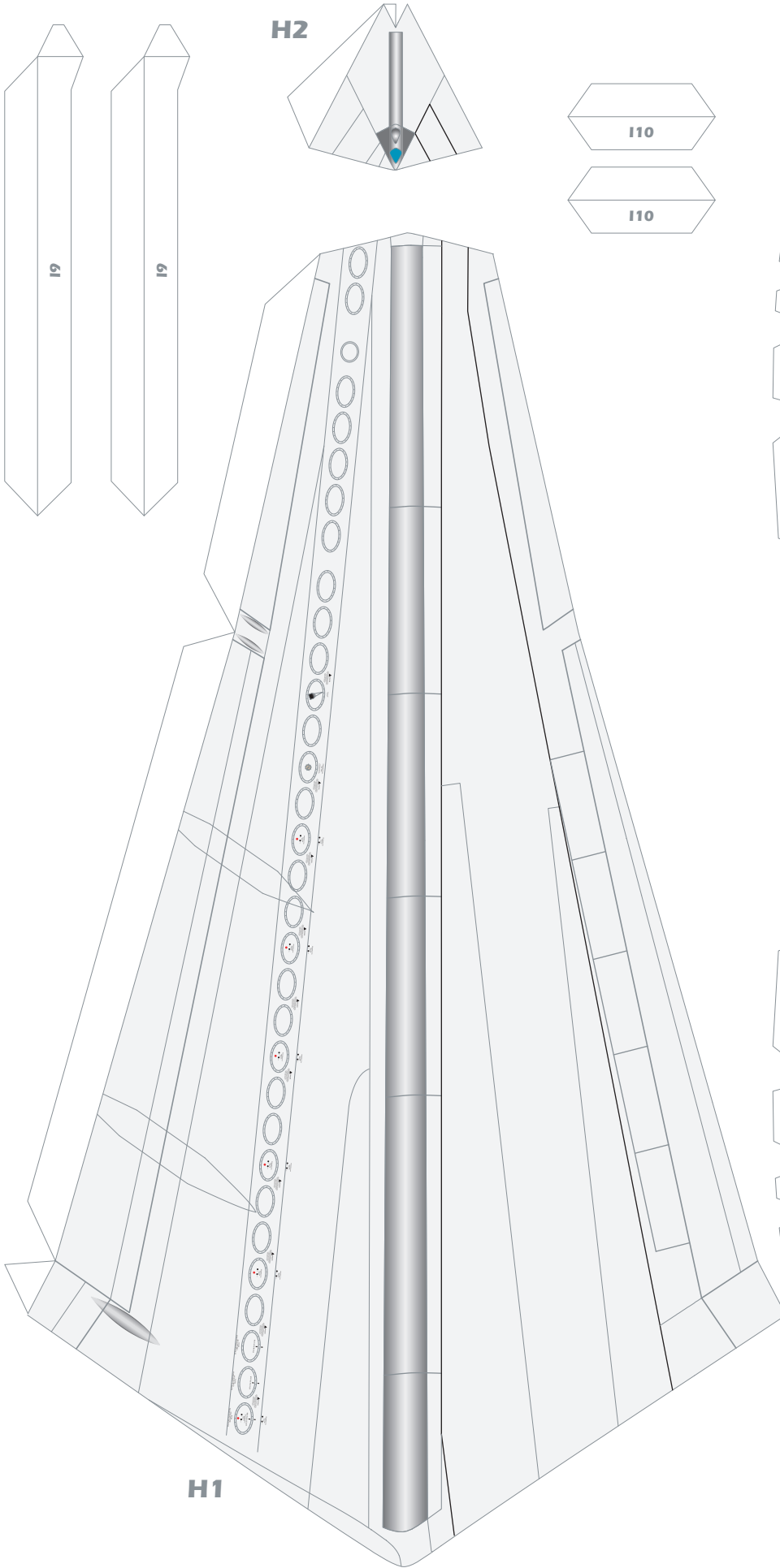

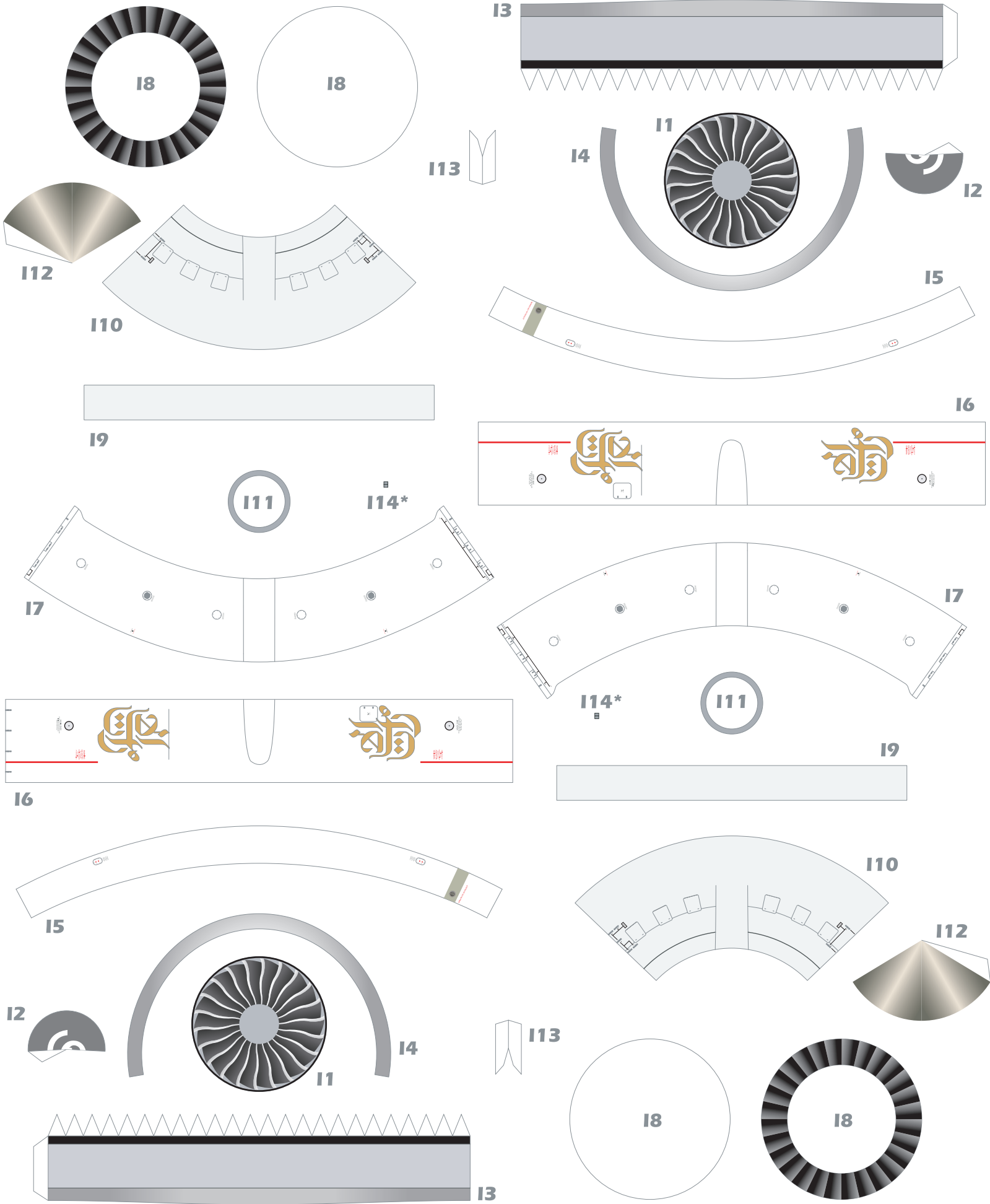

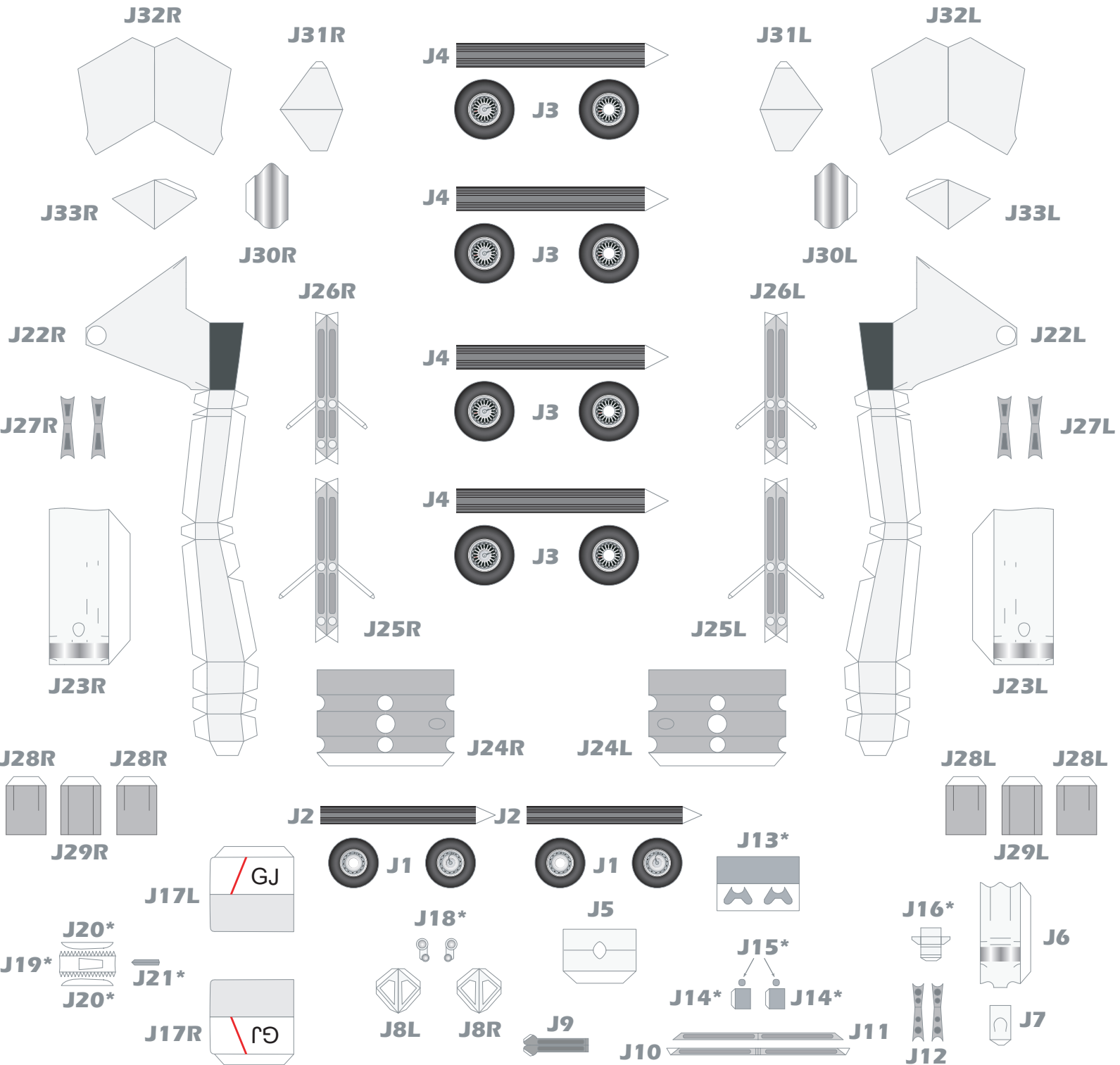
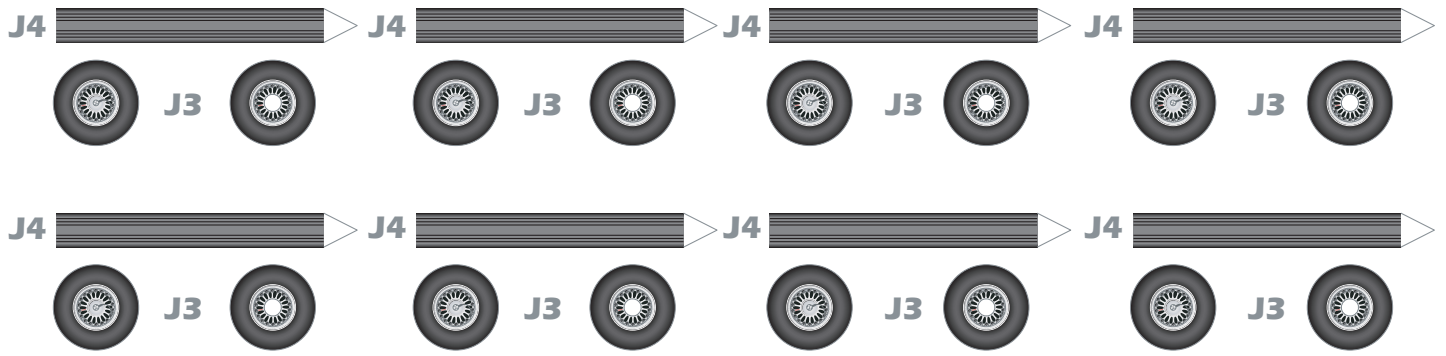

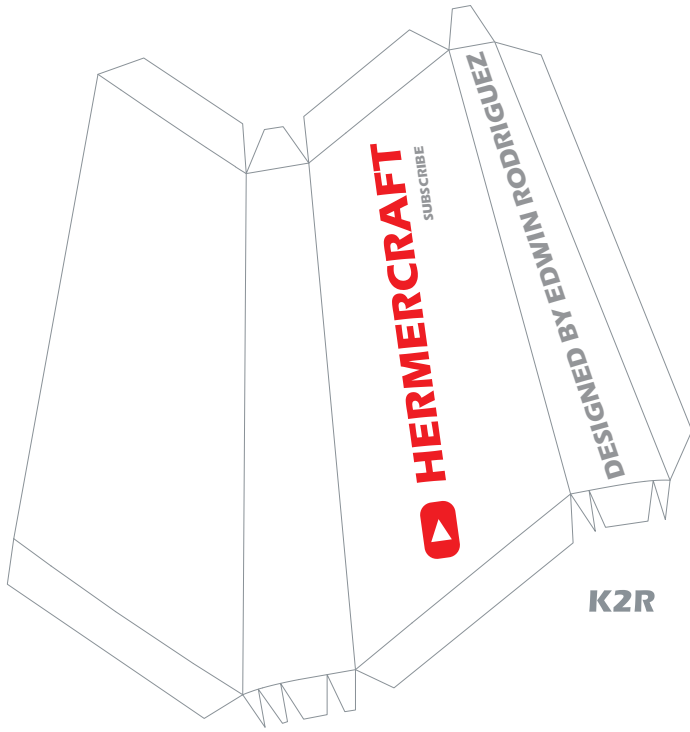

K2R

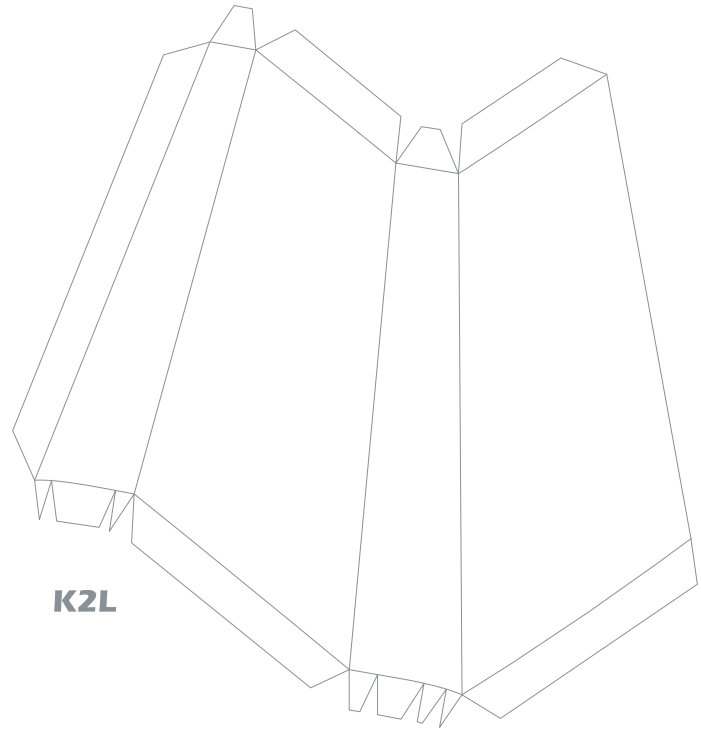

K2L

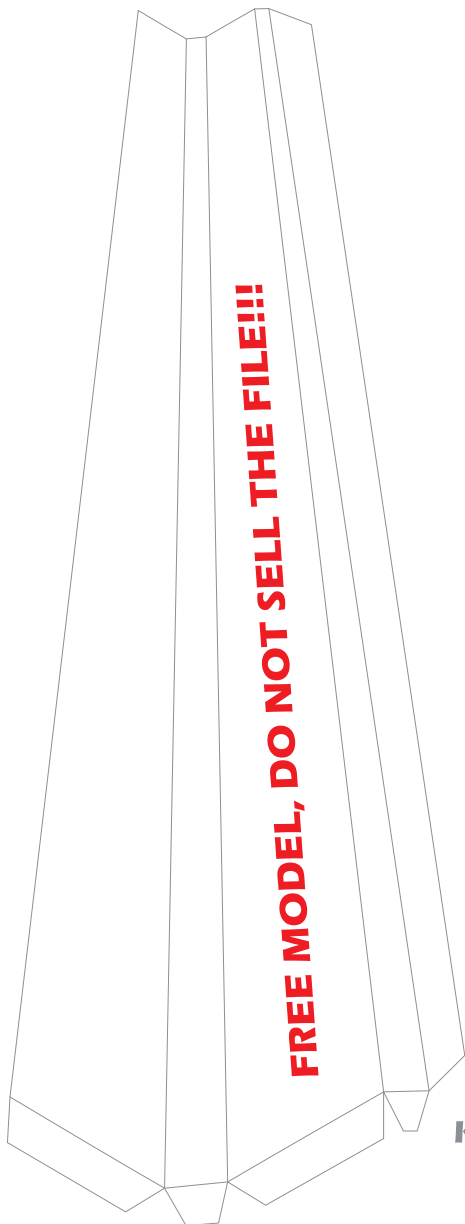

K3R

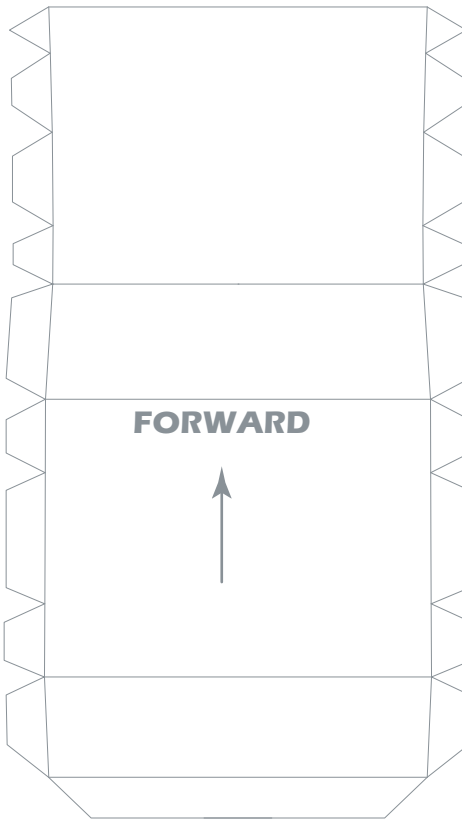

K1

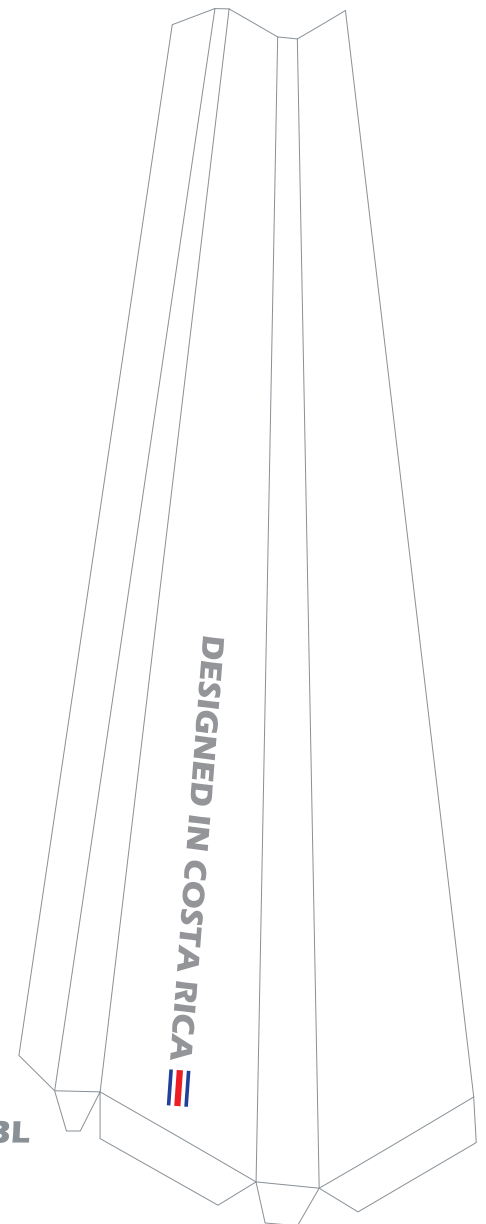

K3L



L5

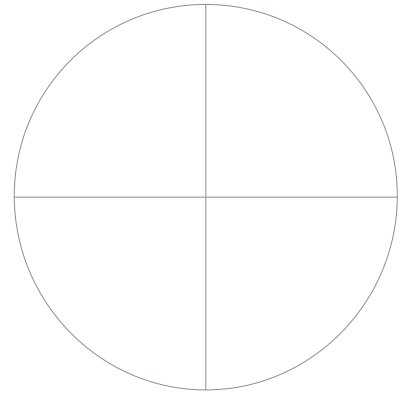
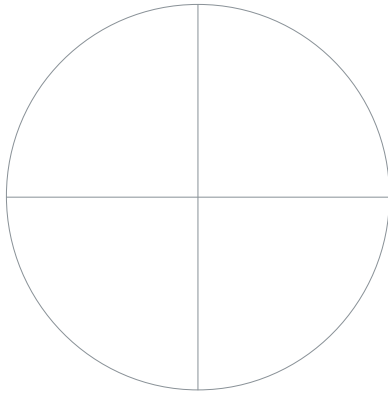
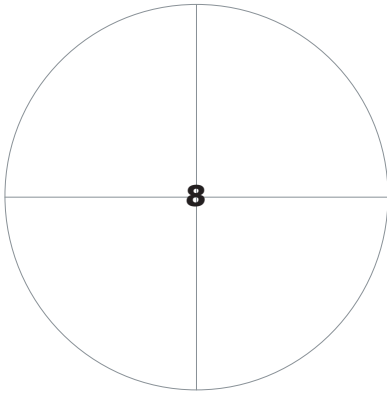

L4

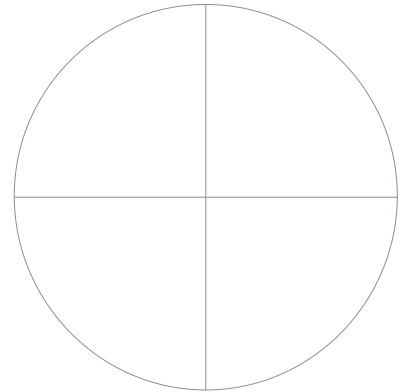
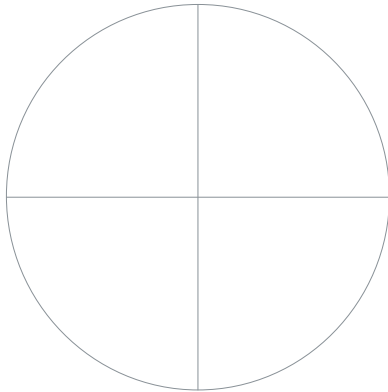
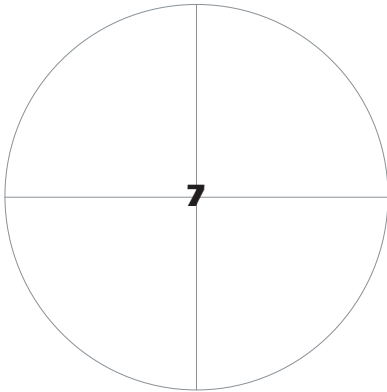

L3

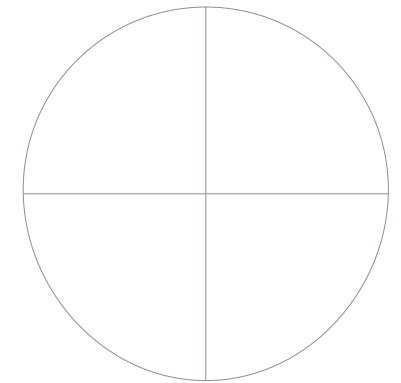
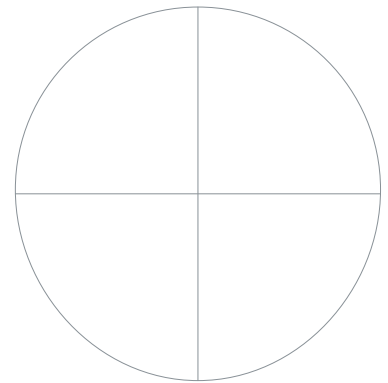
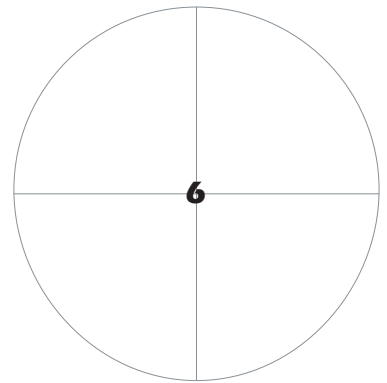

L2

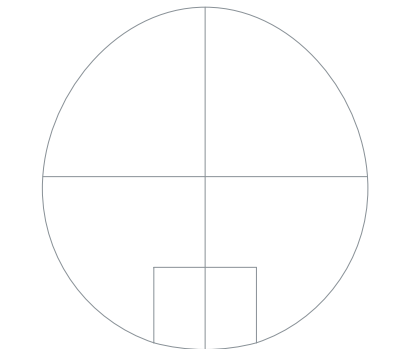
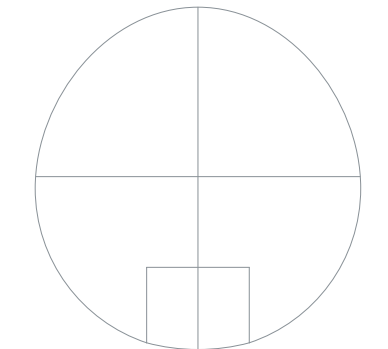
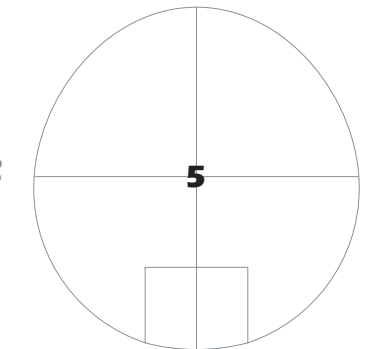

L1

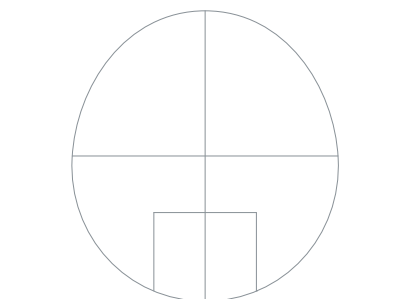
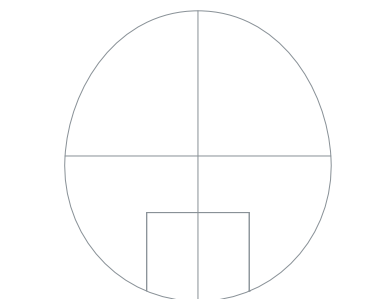
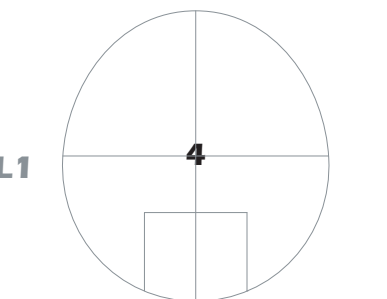



M4

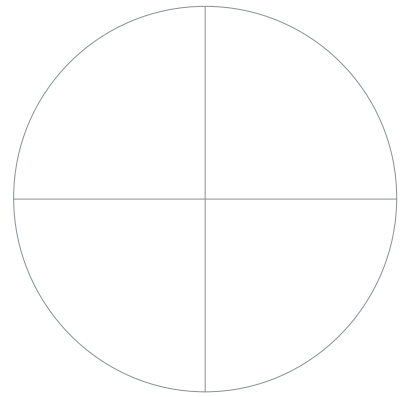
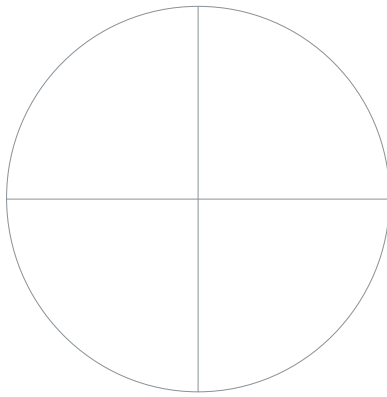
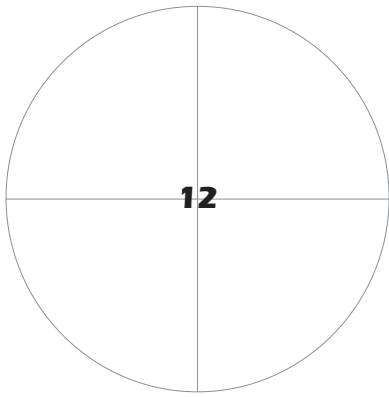

M3

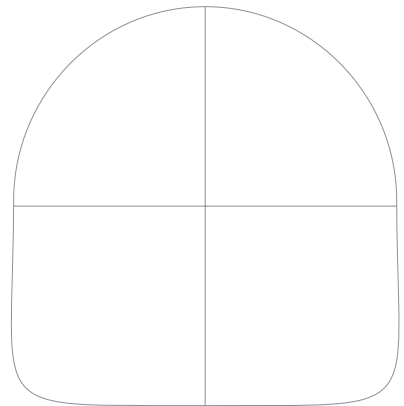
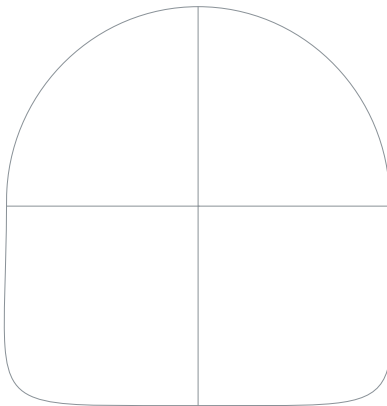
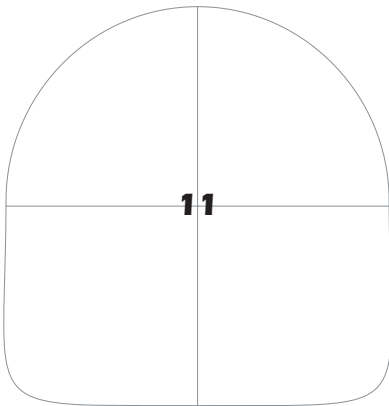

M2

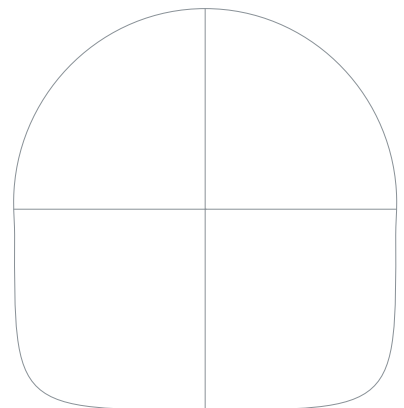
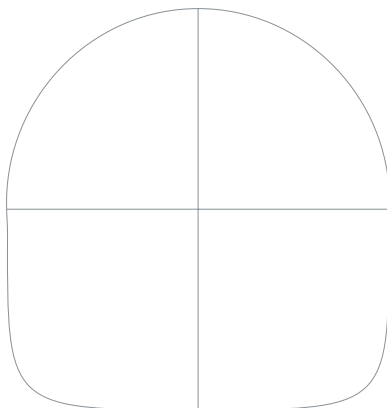
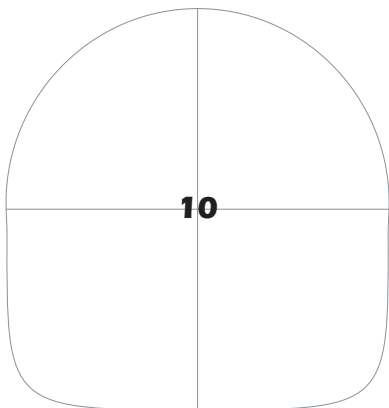

M1

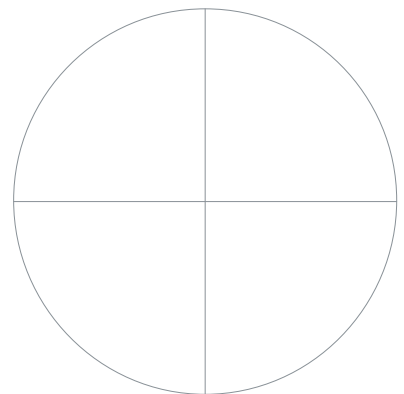
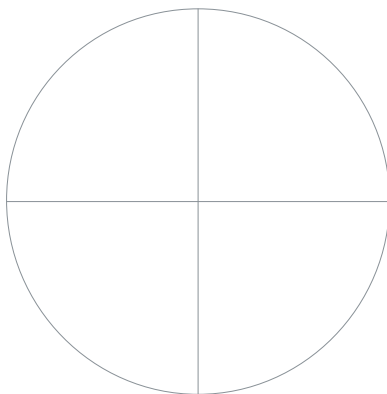
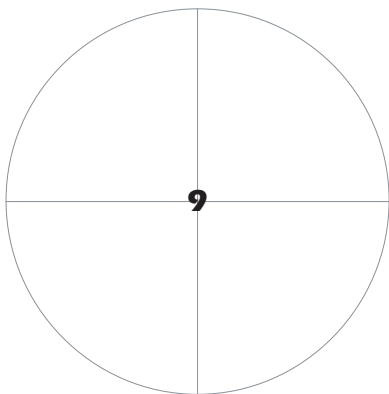

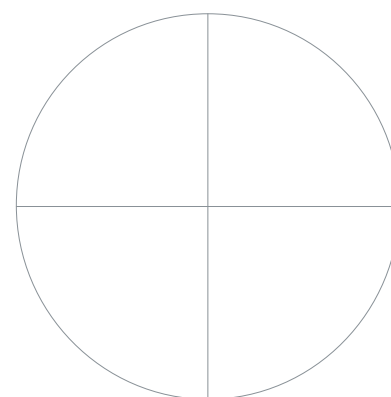
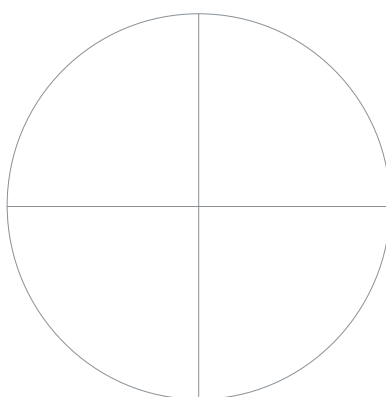
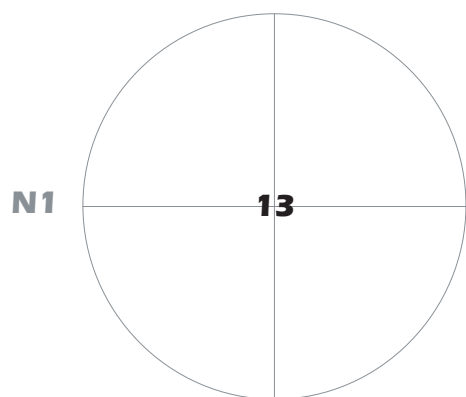
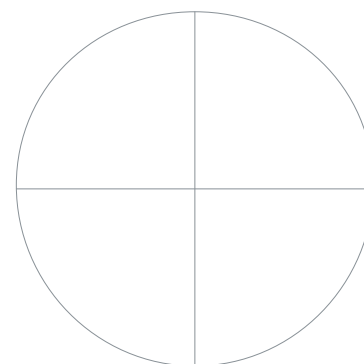
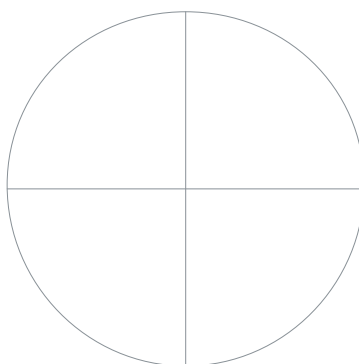
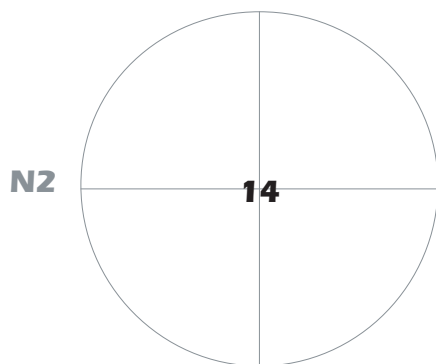
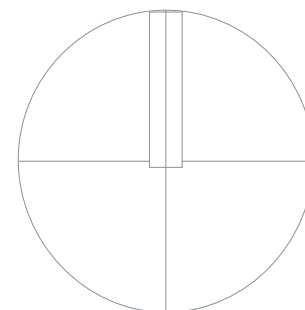
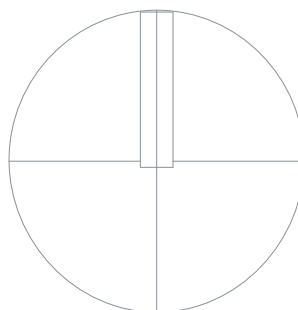
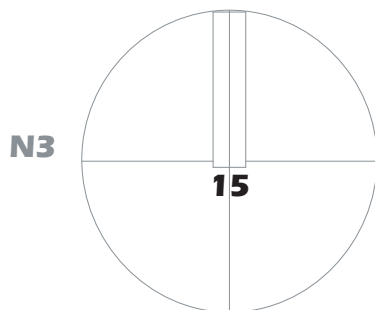
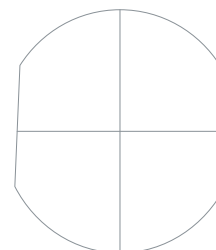
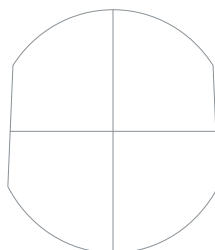
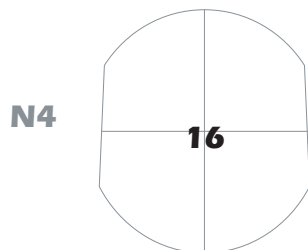
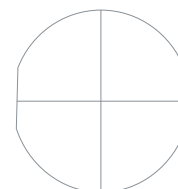
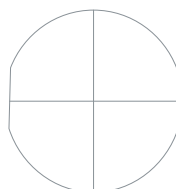

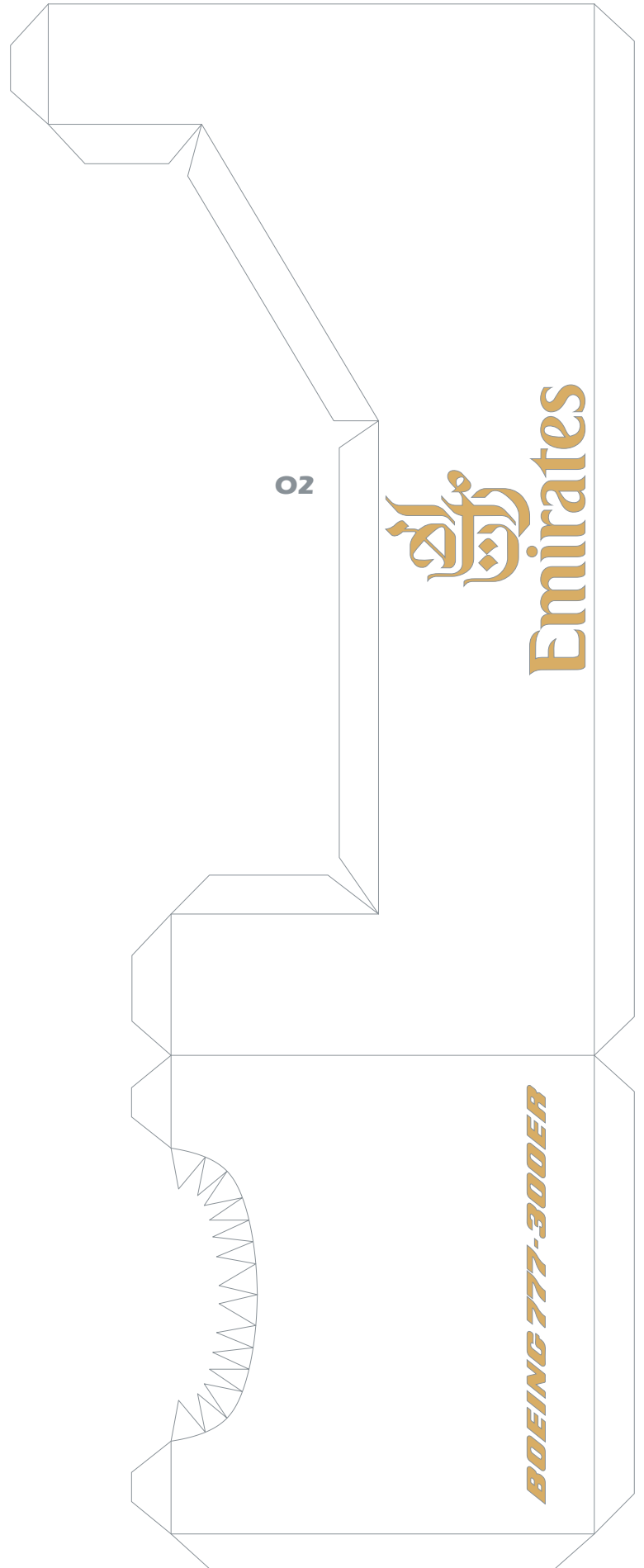
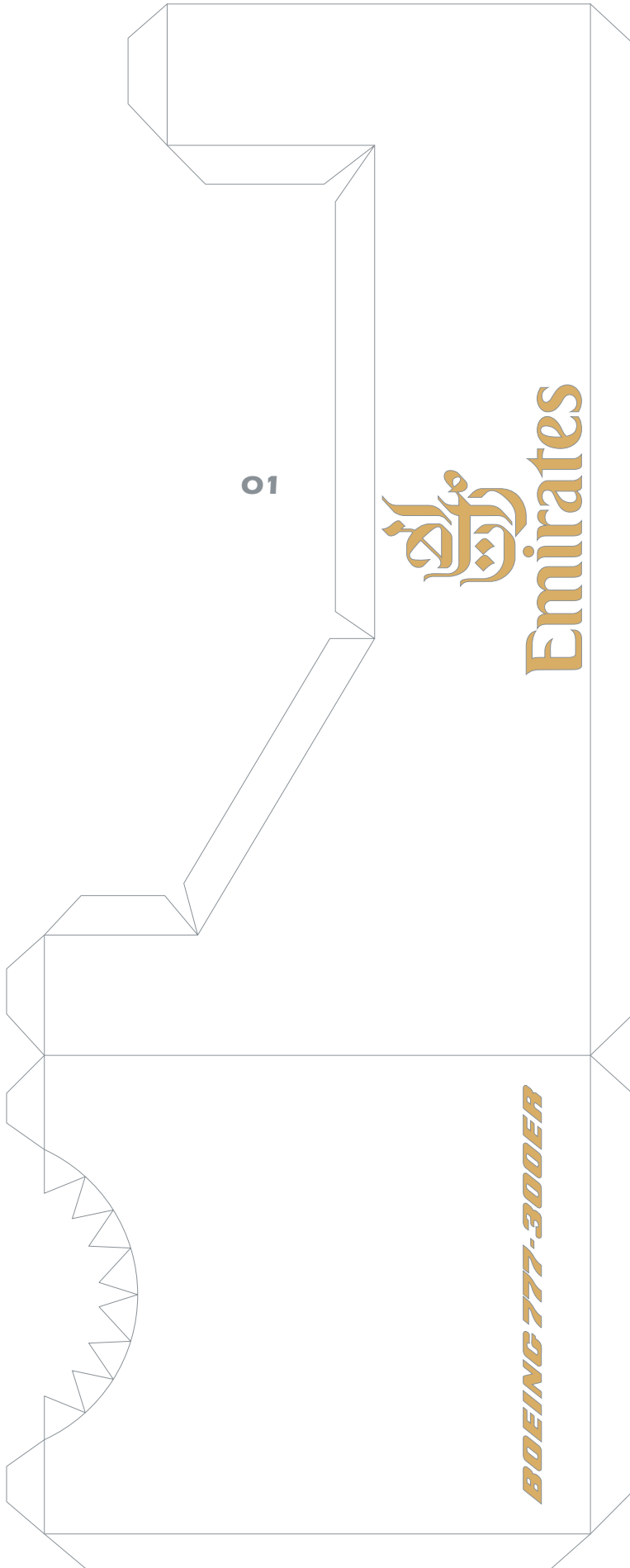

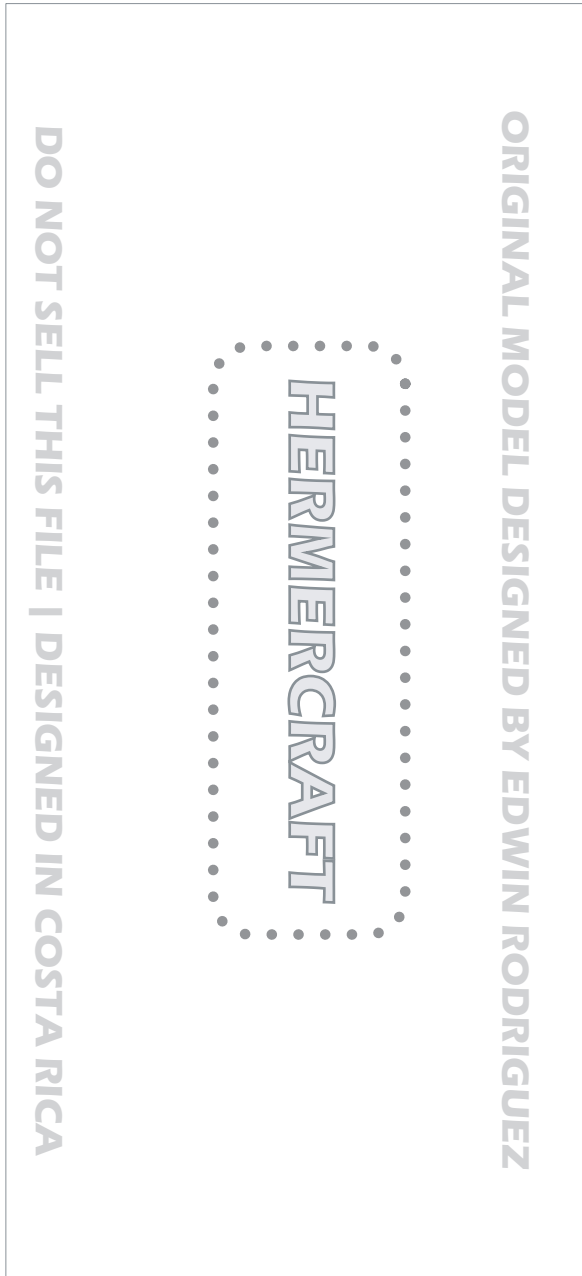

P4

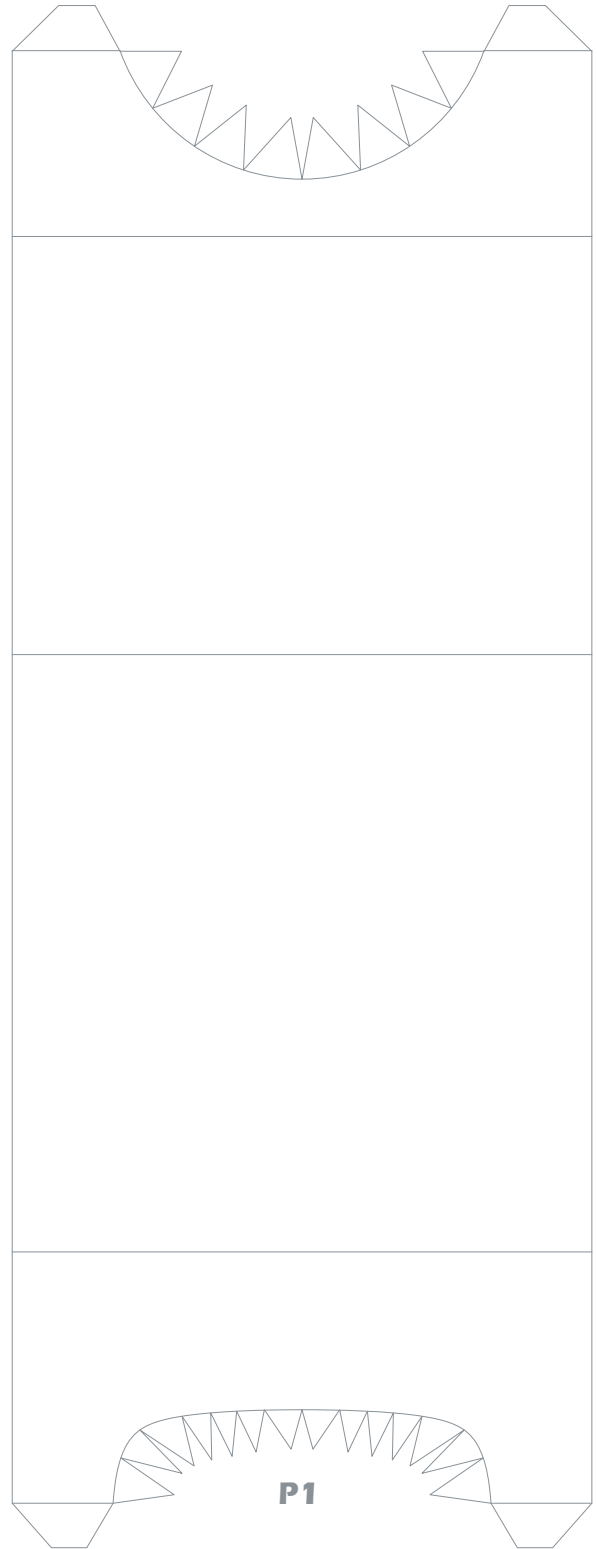

P1



P2



P3

