

Blank space for 787-10 variant

Instructions



Scan

A14

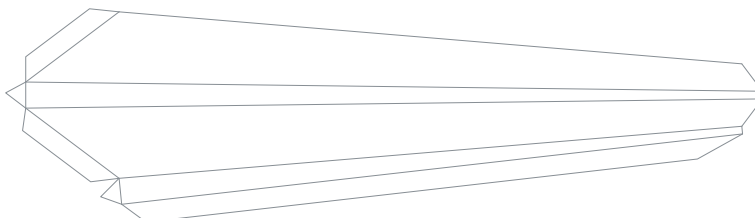

A16L

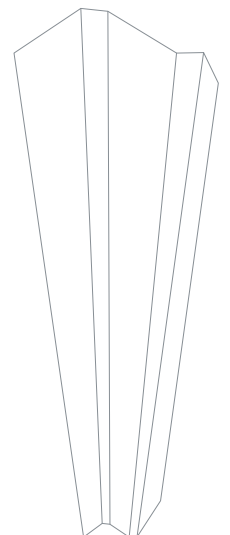

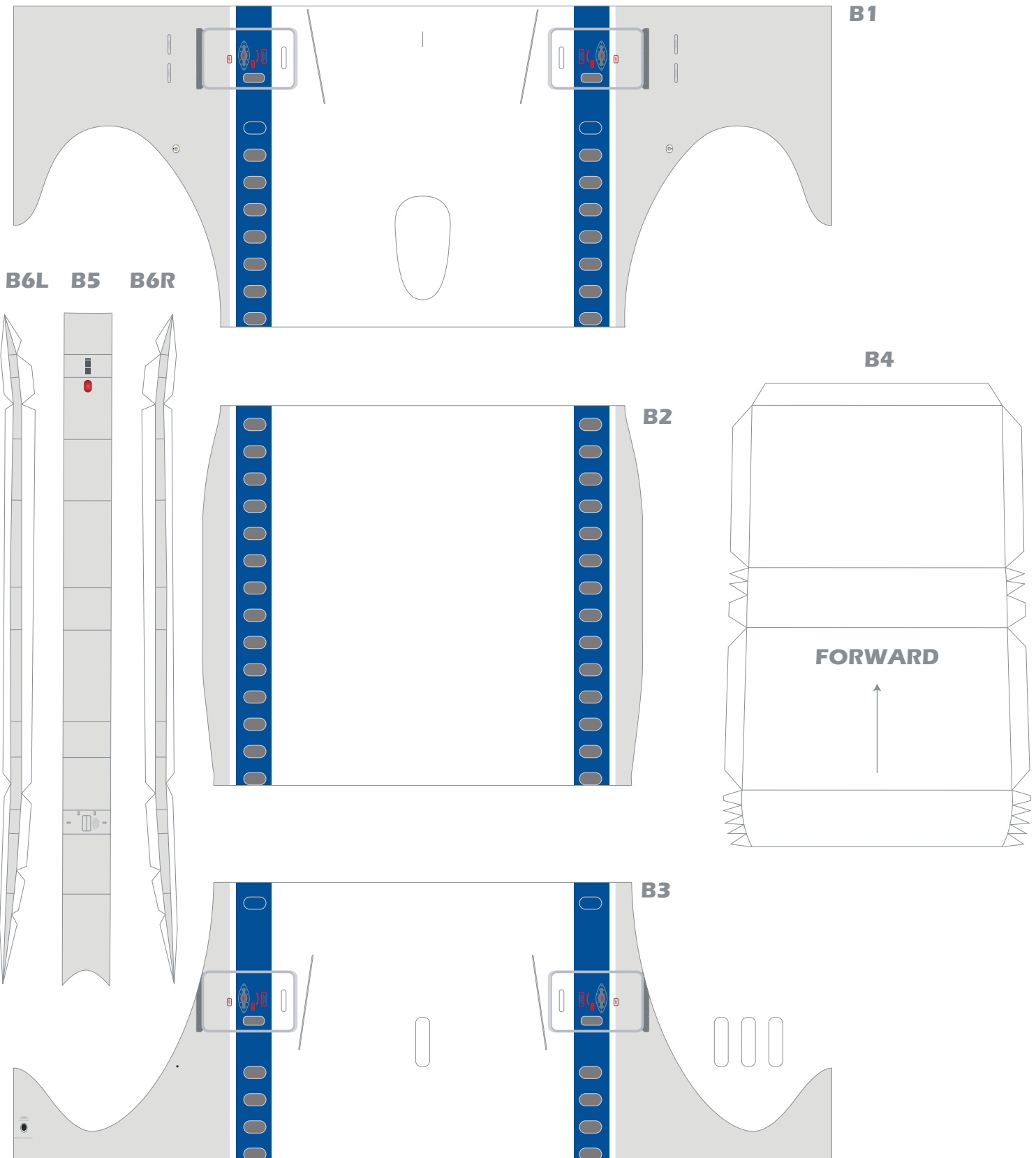

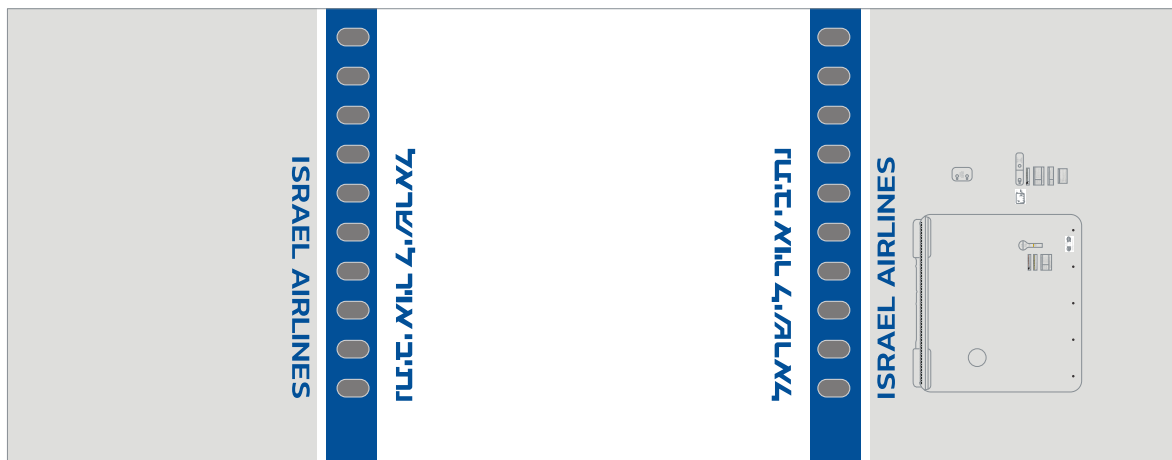

C1

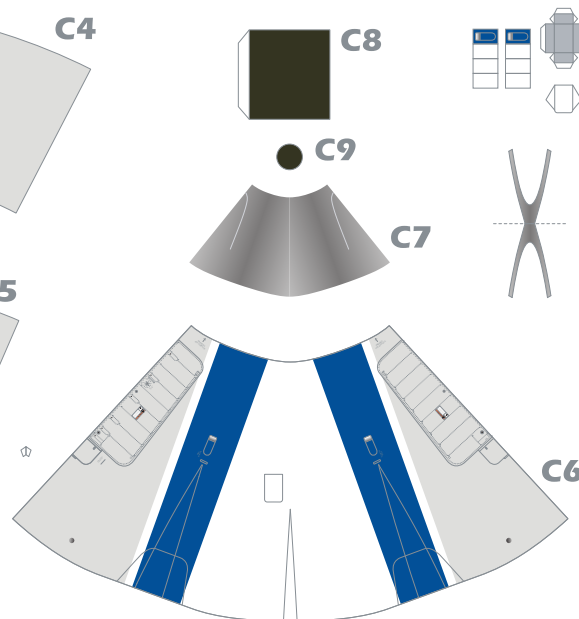
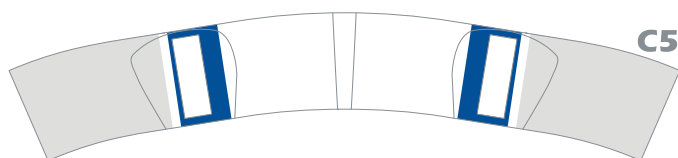
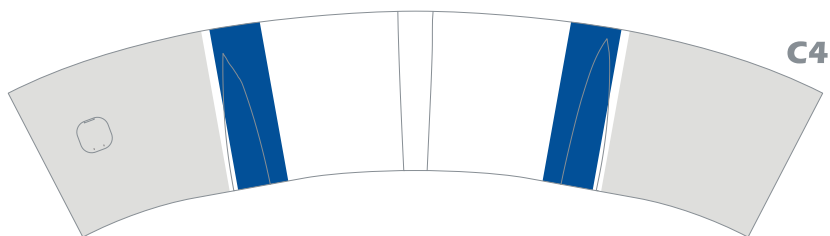
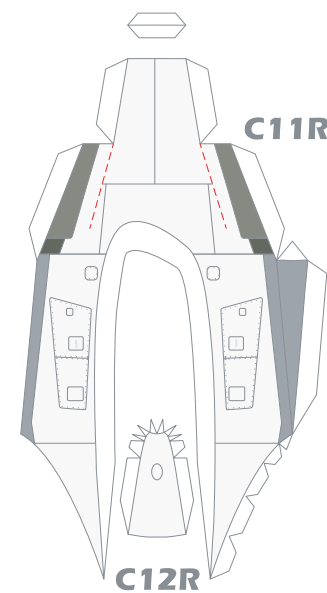
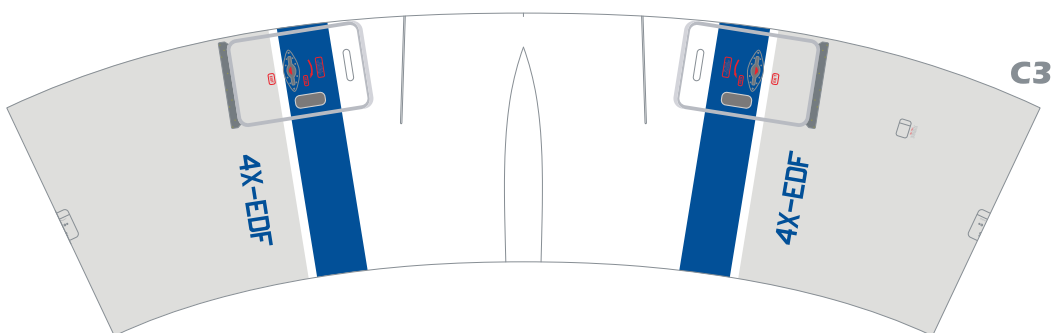
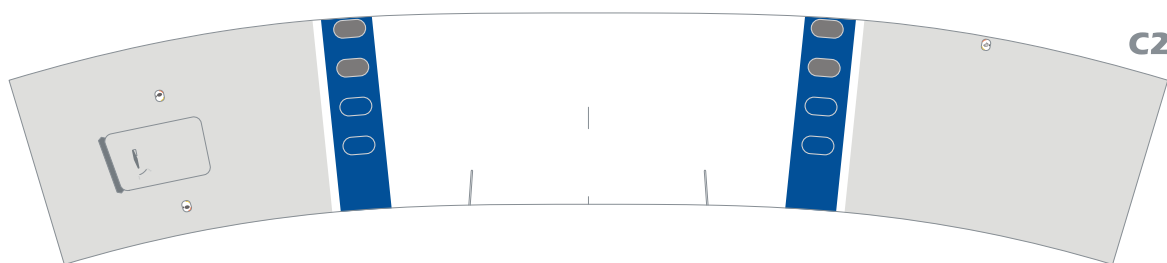
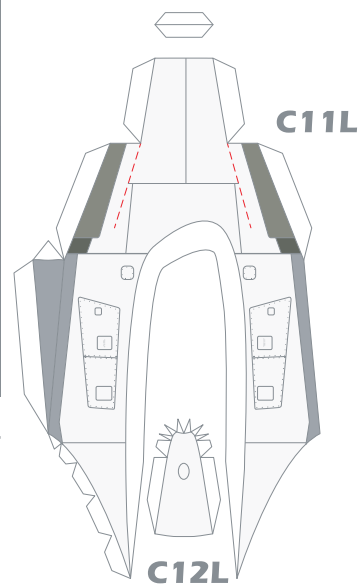

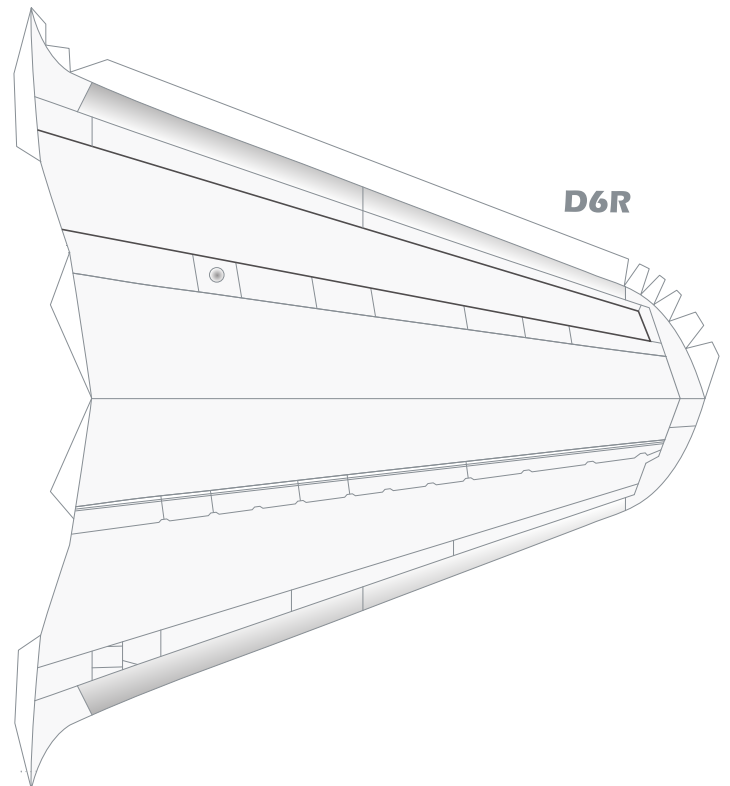
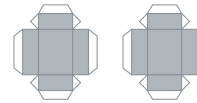
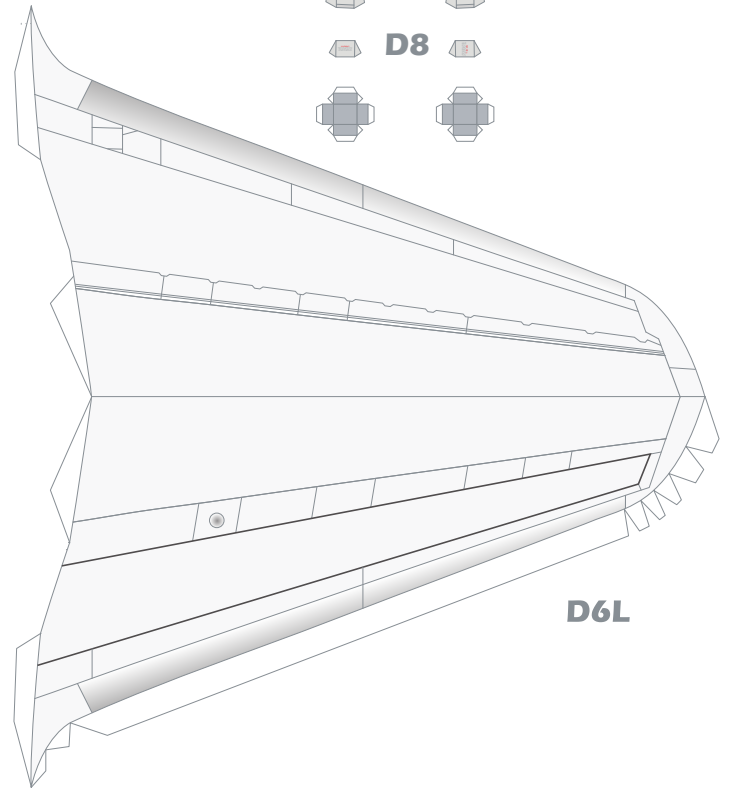
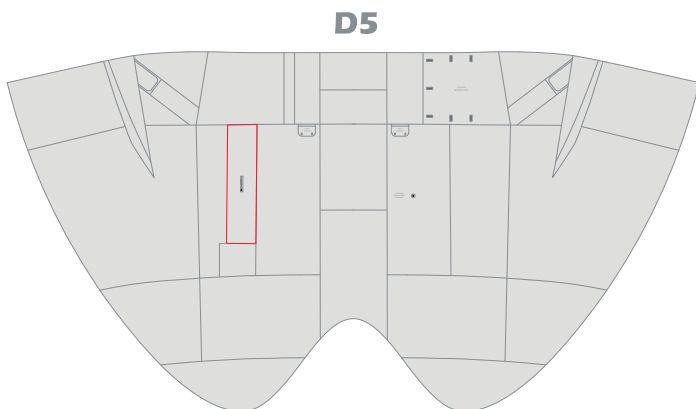
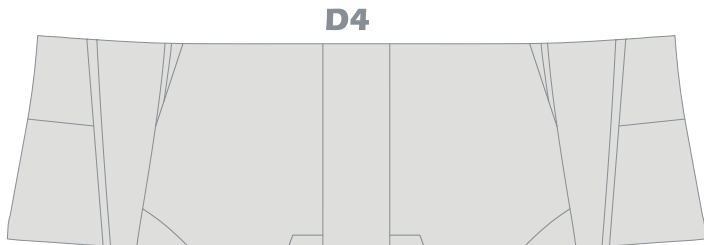
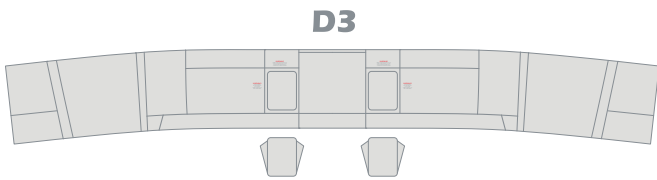
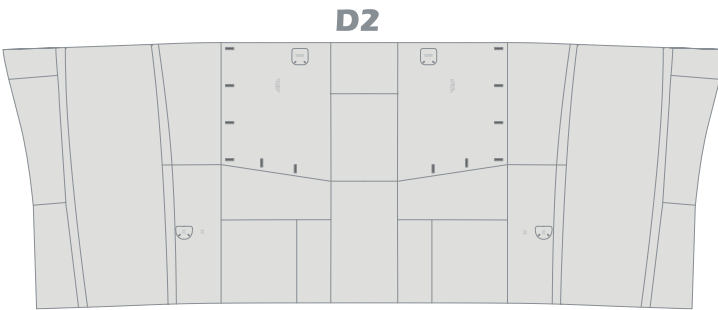
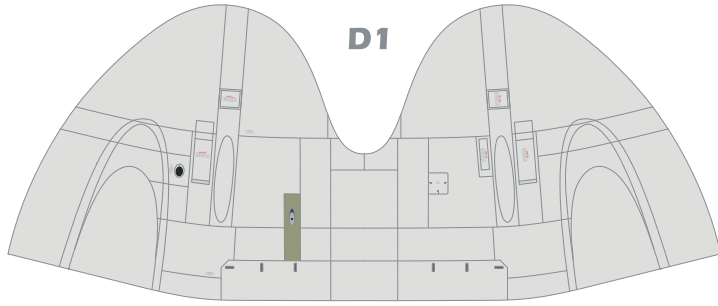

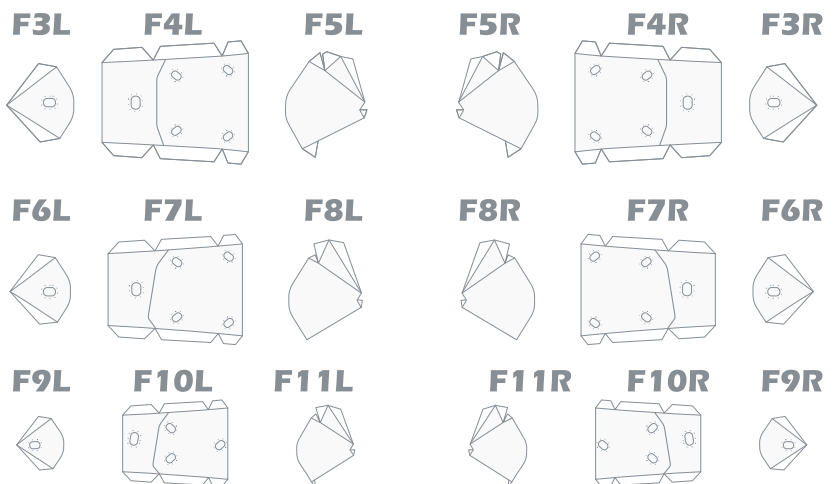
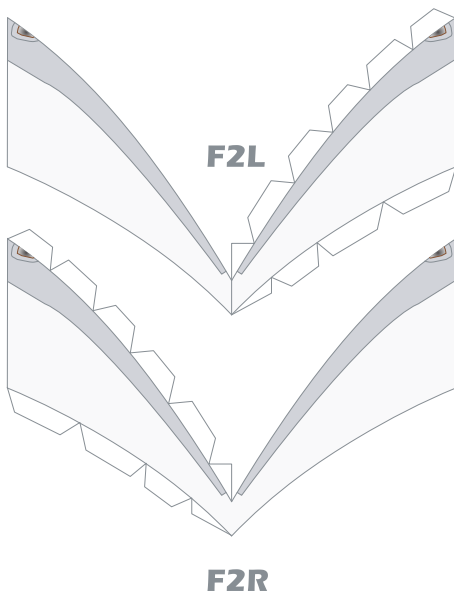
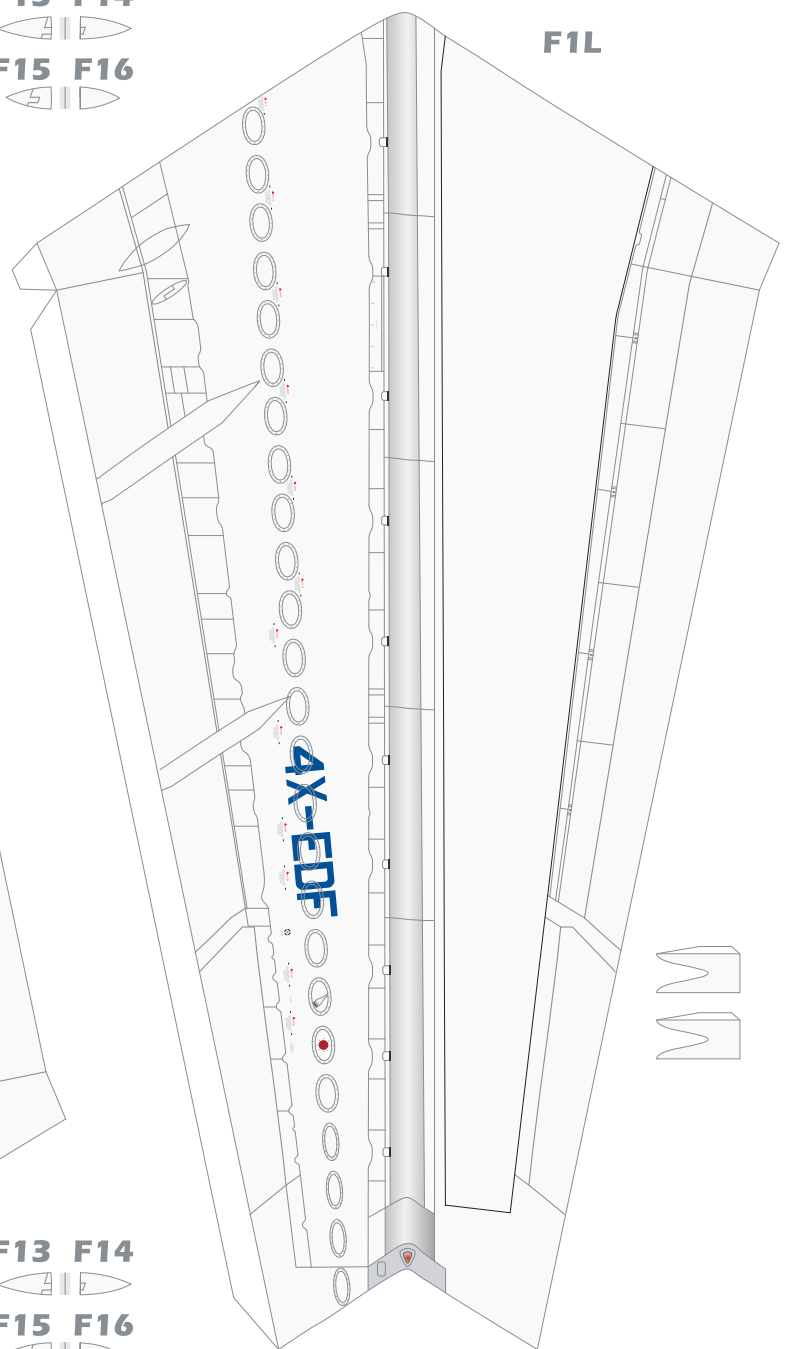
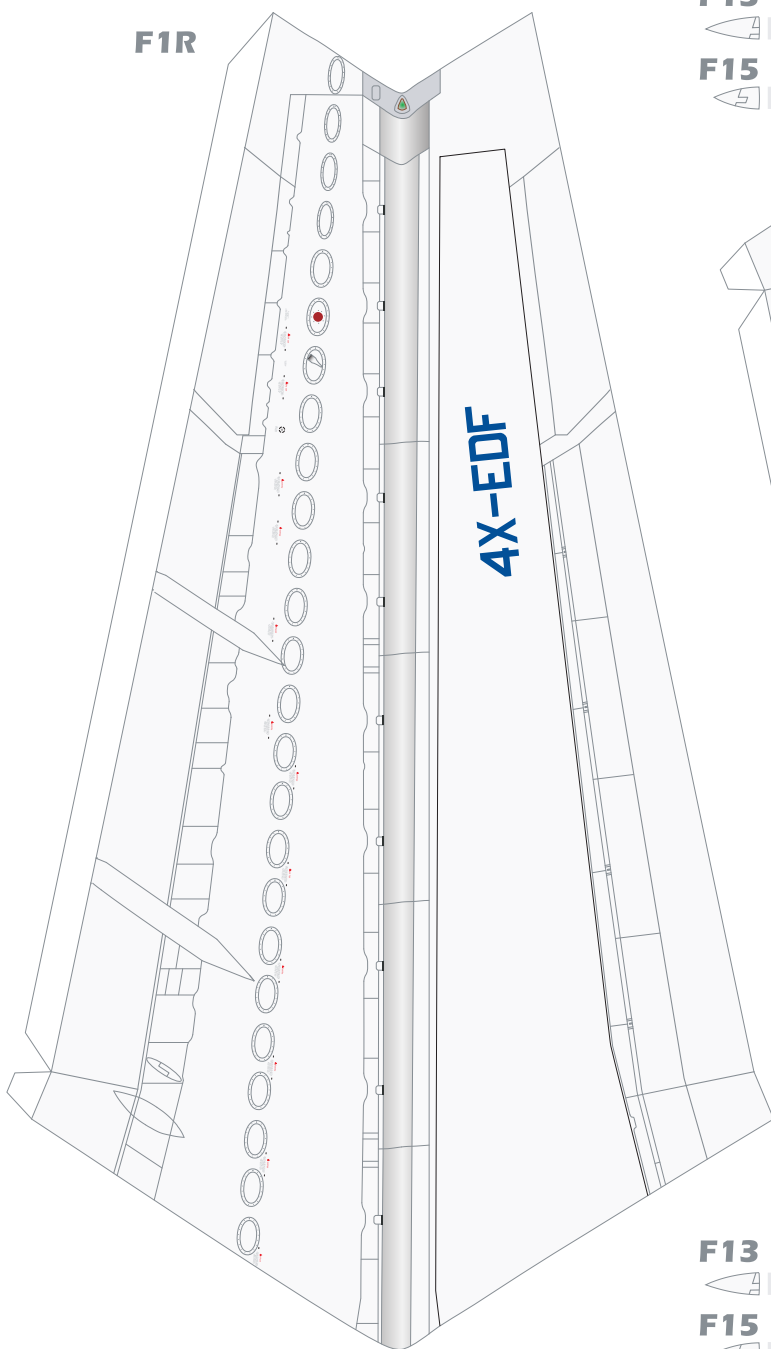

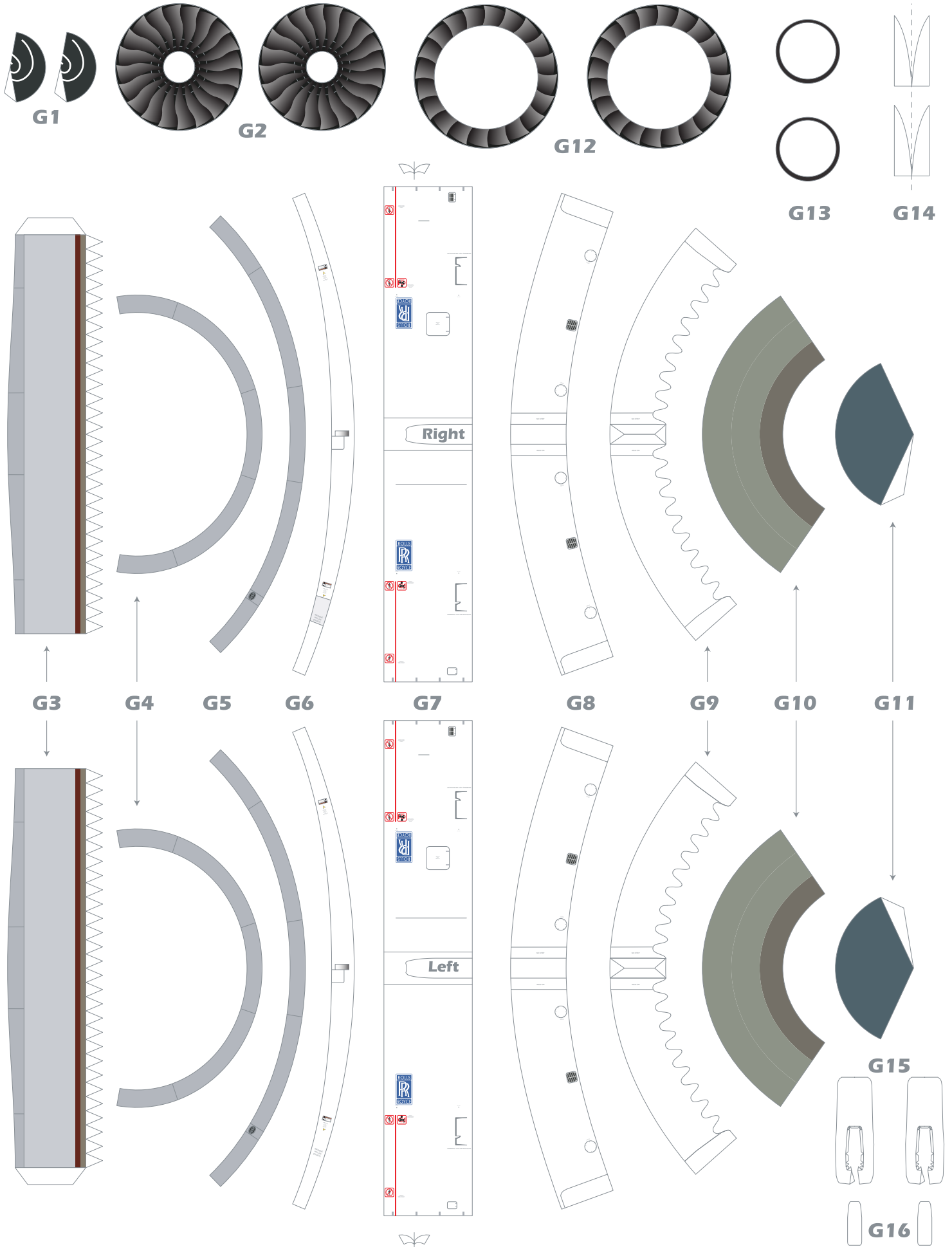

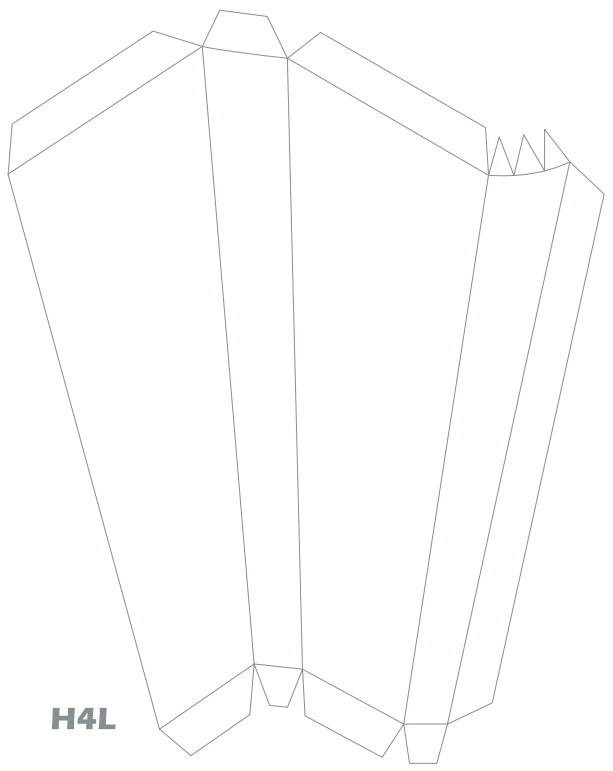
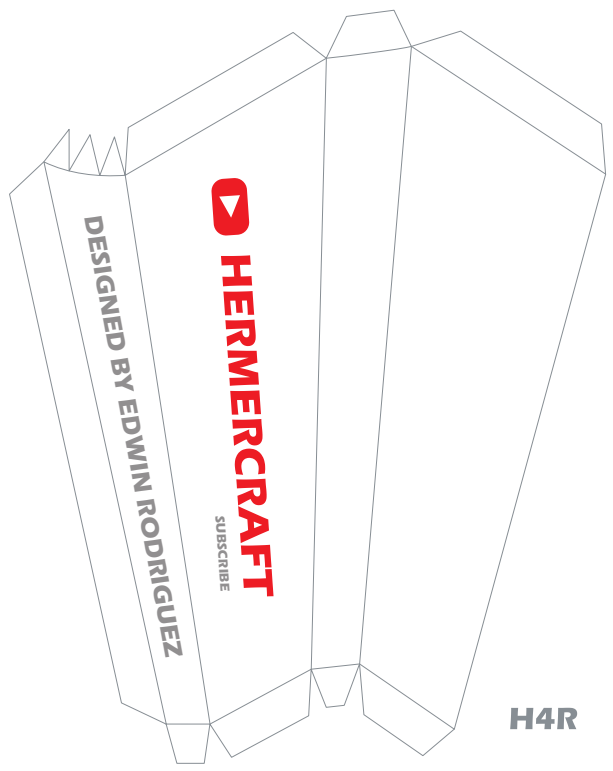
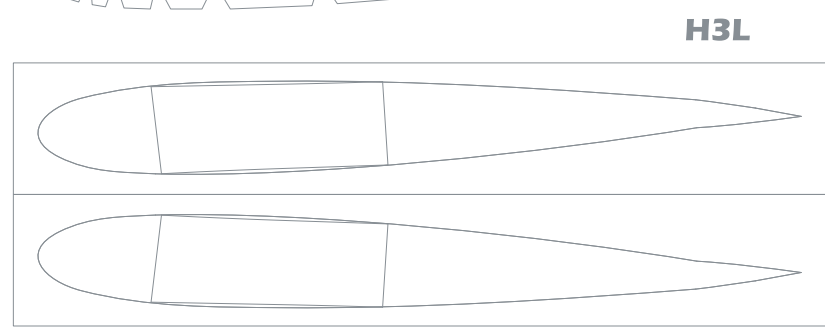
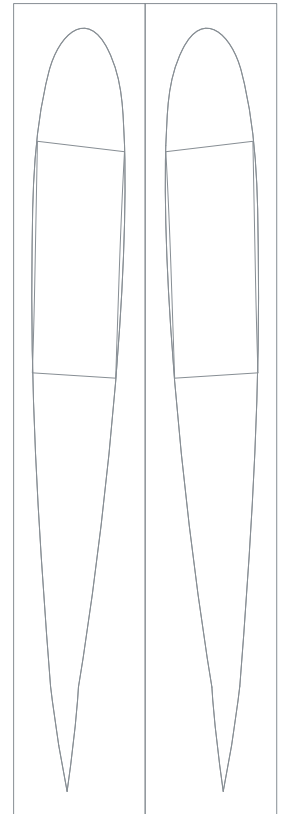
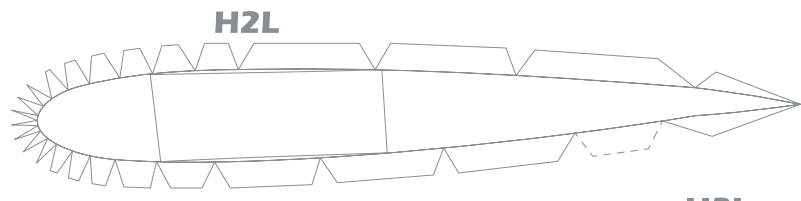
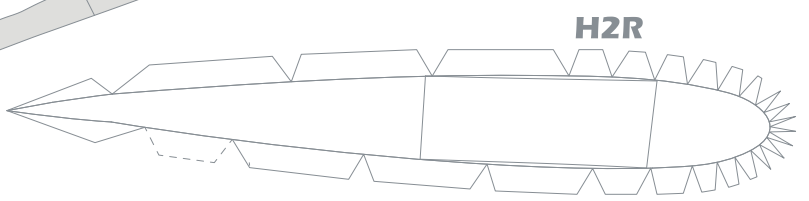
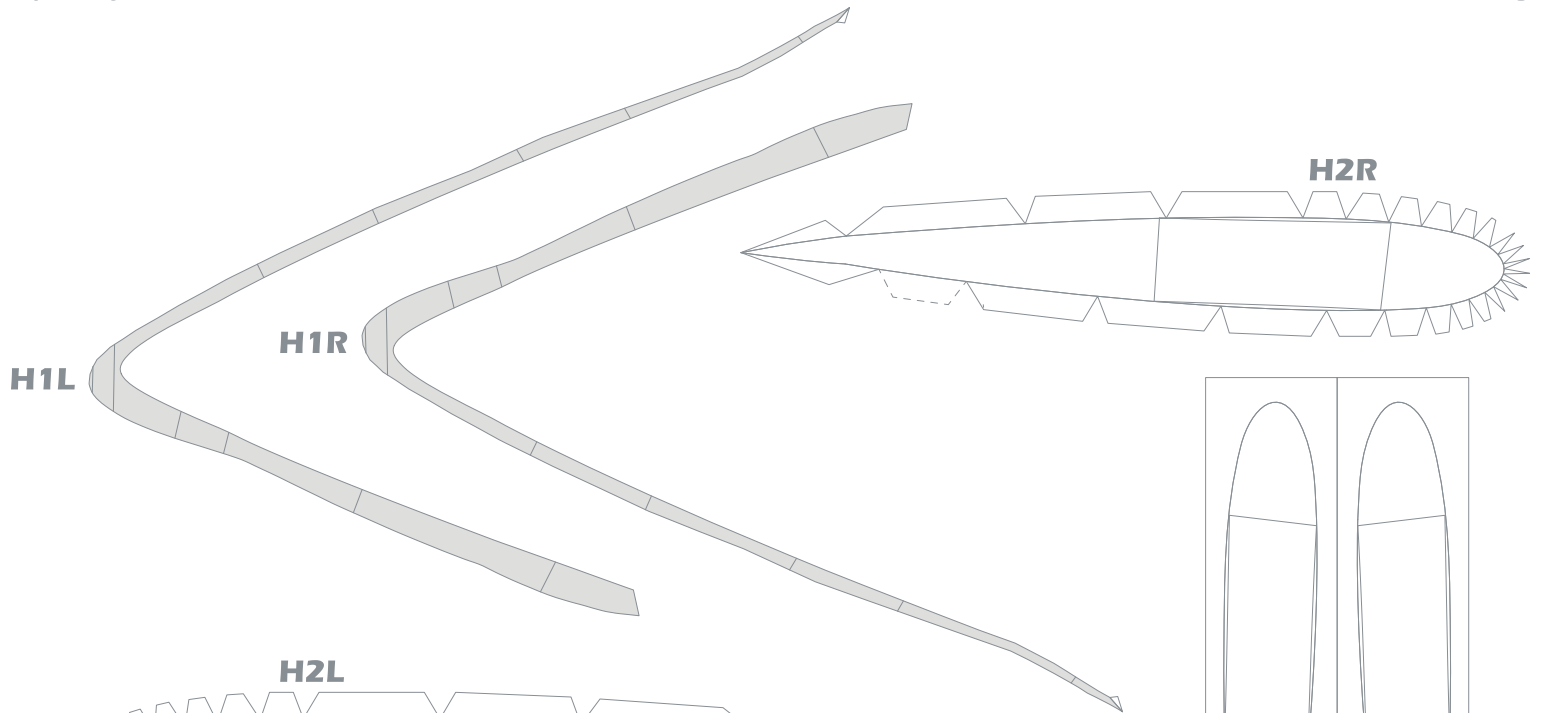

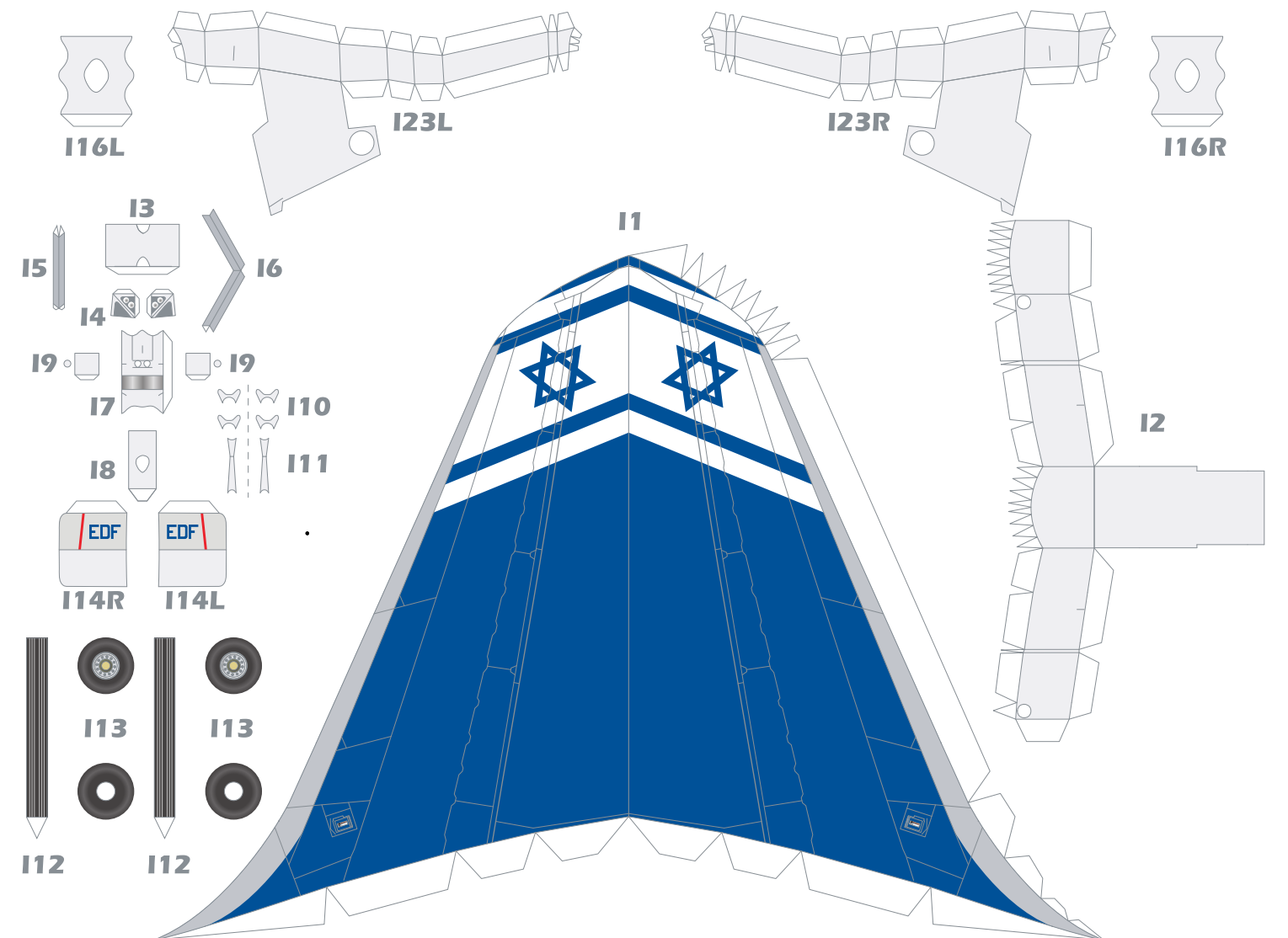
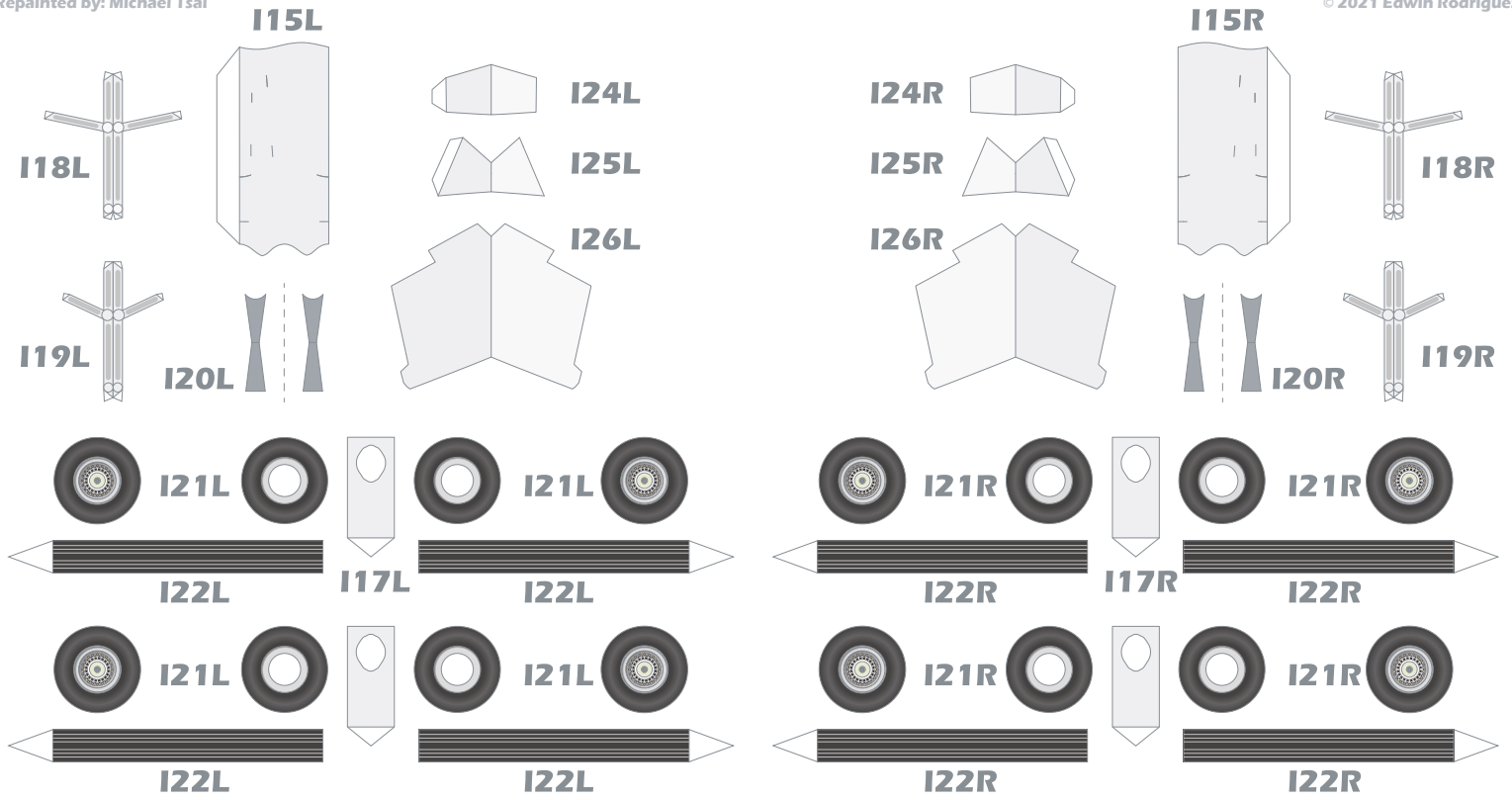

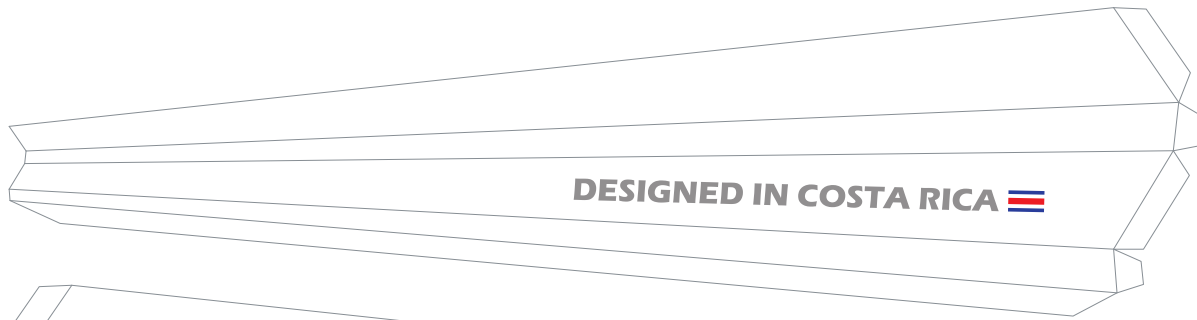

J1L

DESIGNED IN COSTA RICA 



J1R

FREE MODEL, DO NOT SELL THE FILE!!!

