

- B5*
- B7*
- B9*
- B6*
- B8*
- B10*

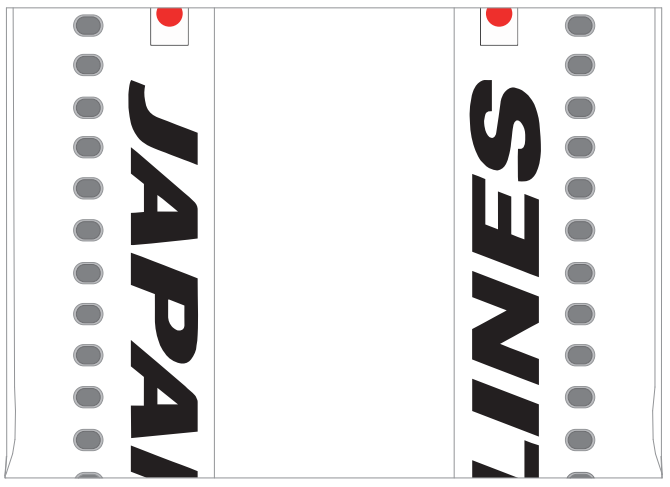

B3

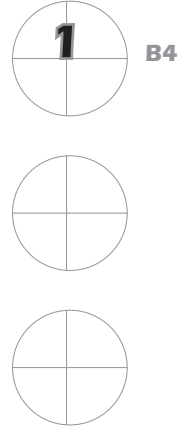
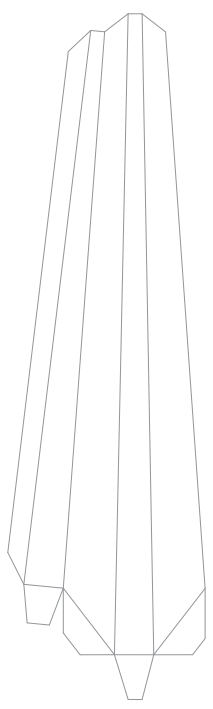

B13

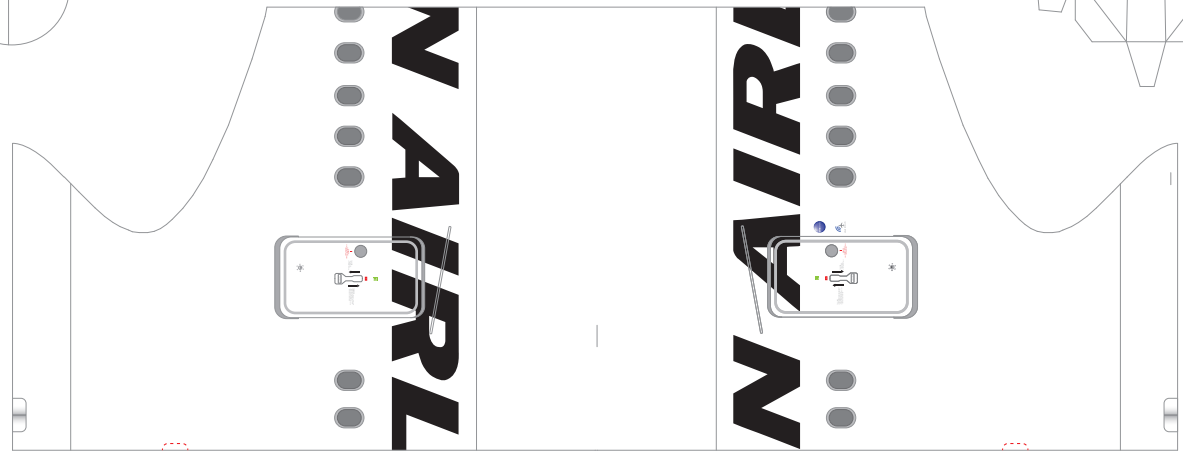

B2

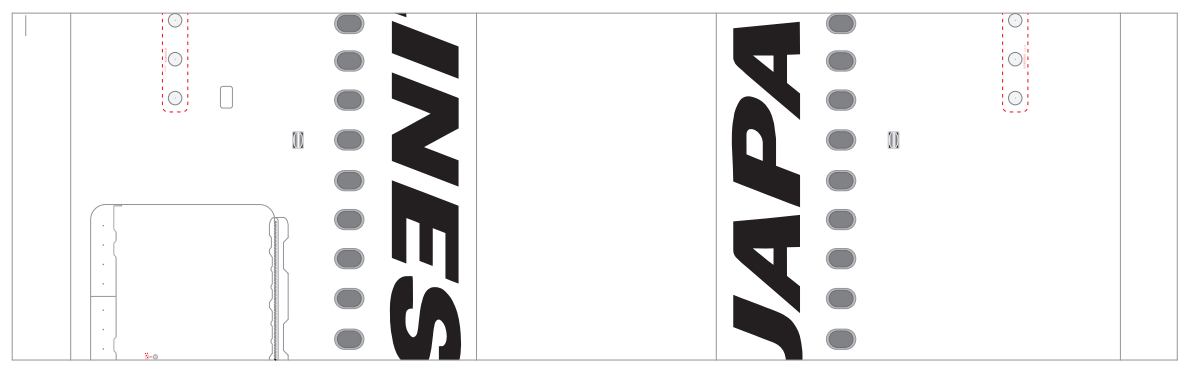

B1

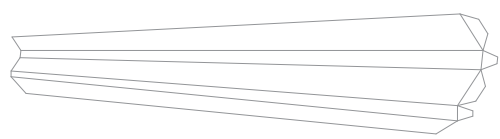

B12R

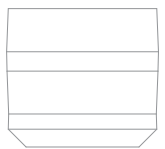

B11

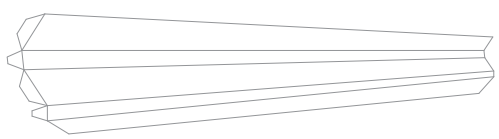

B12L

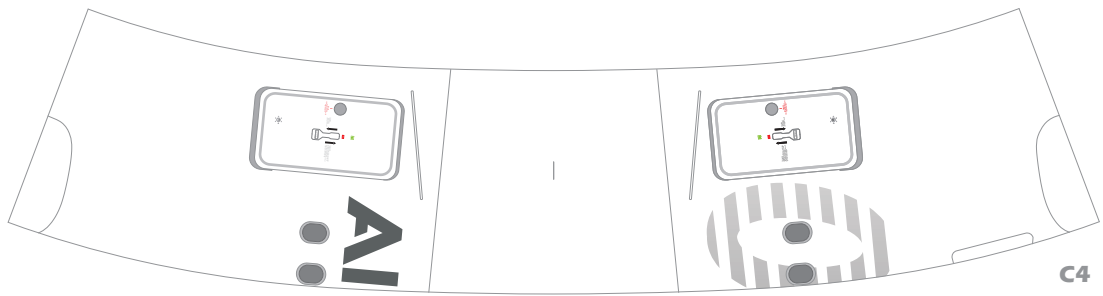

C4

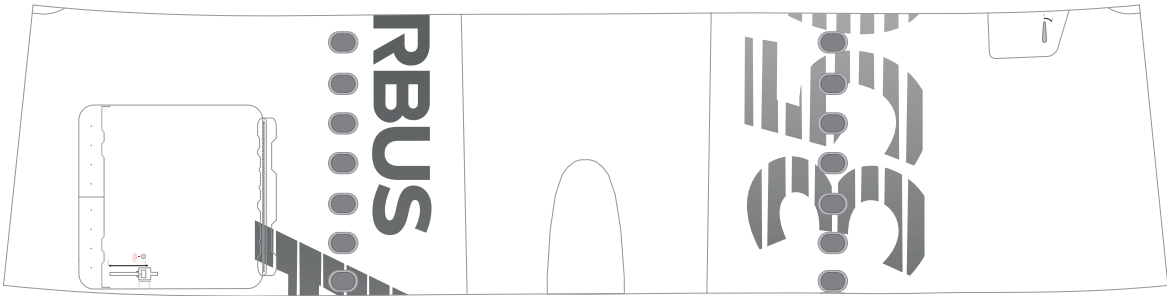

C3

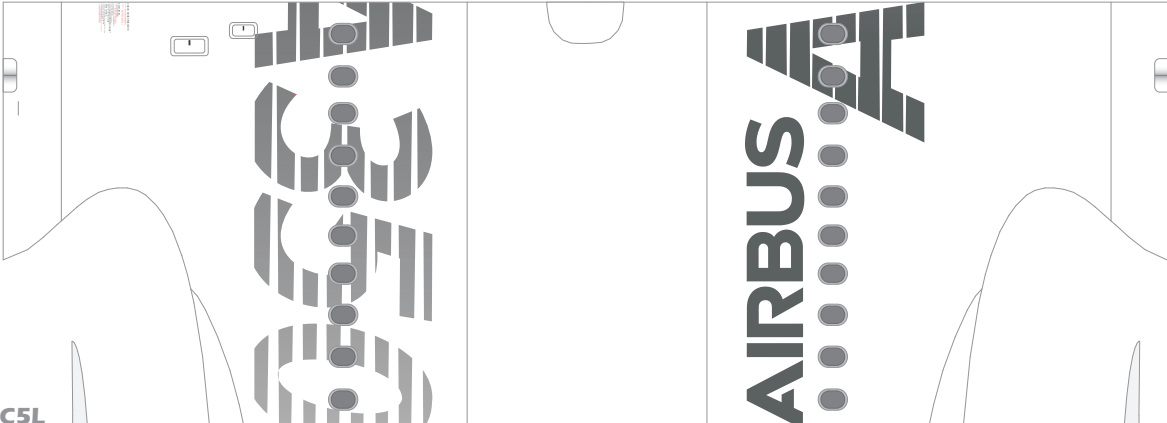

C2

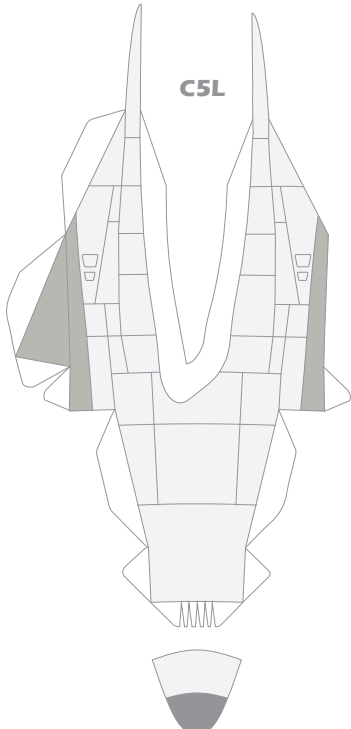

C5L

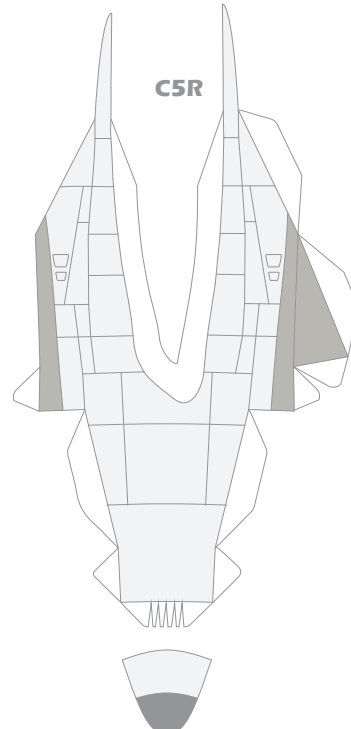

C5R

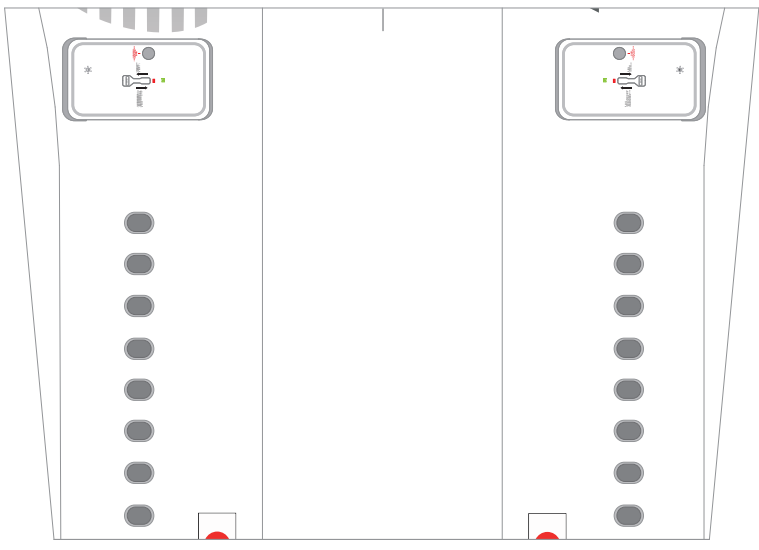

C1

C6L

C6R

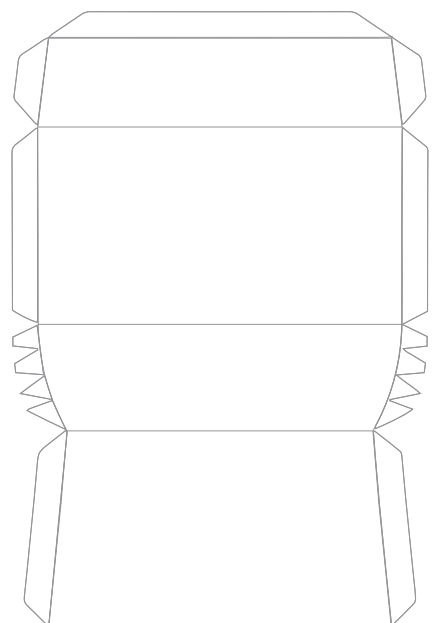
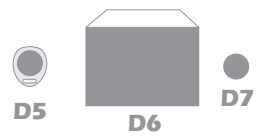
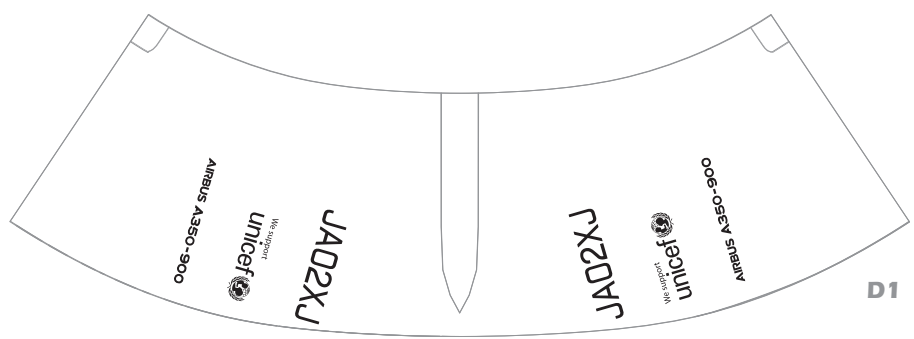
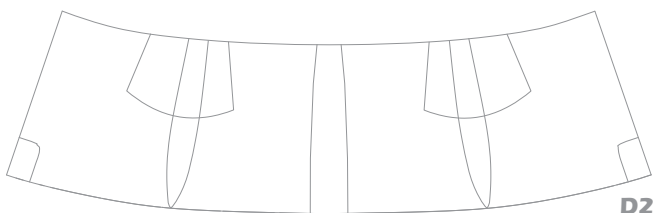
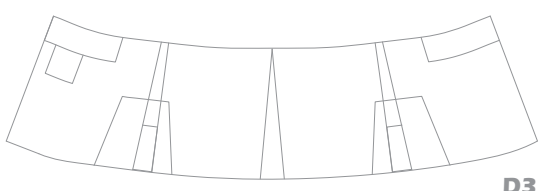
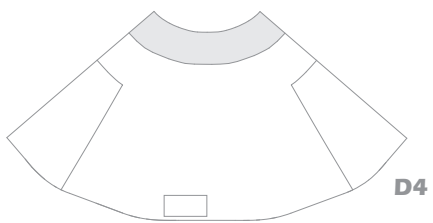
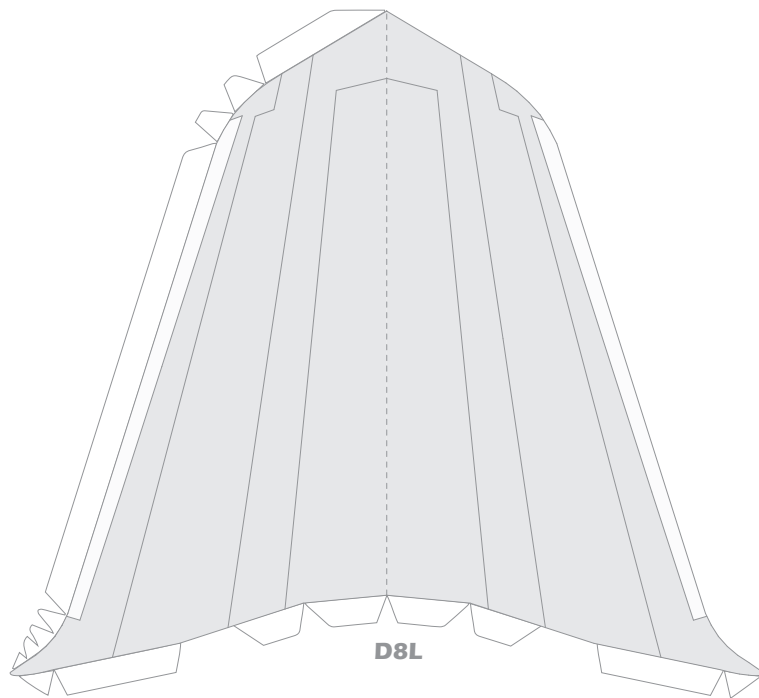
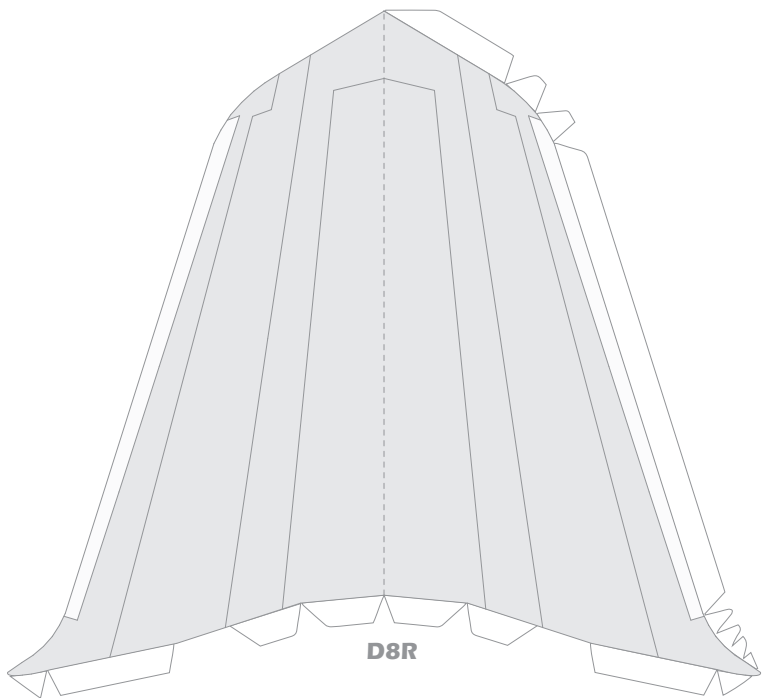

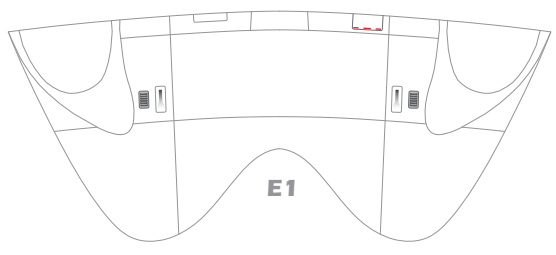
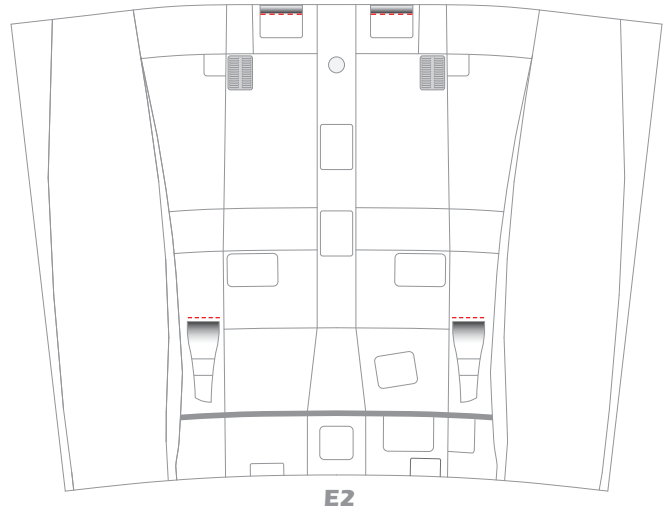
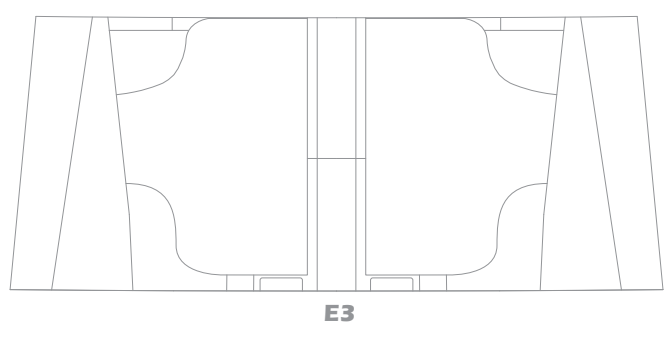
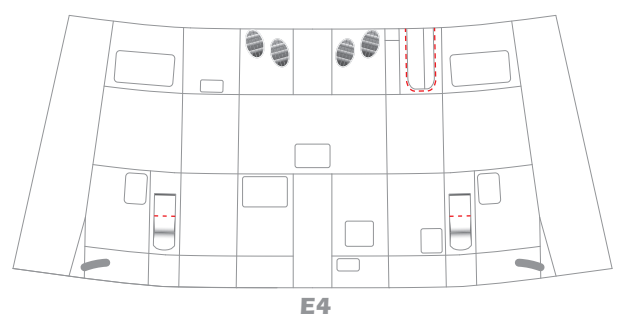
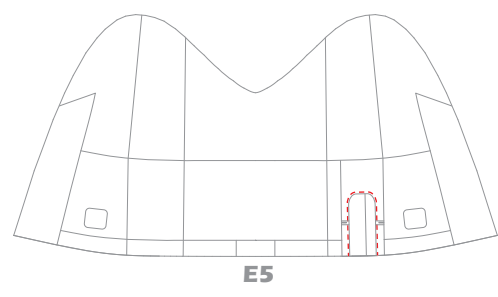
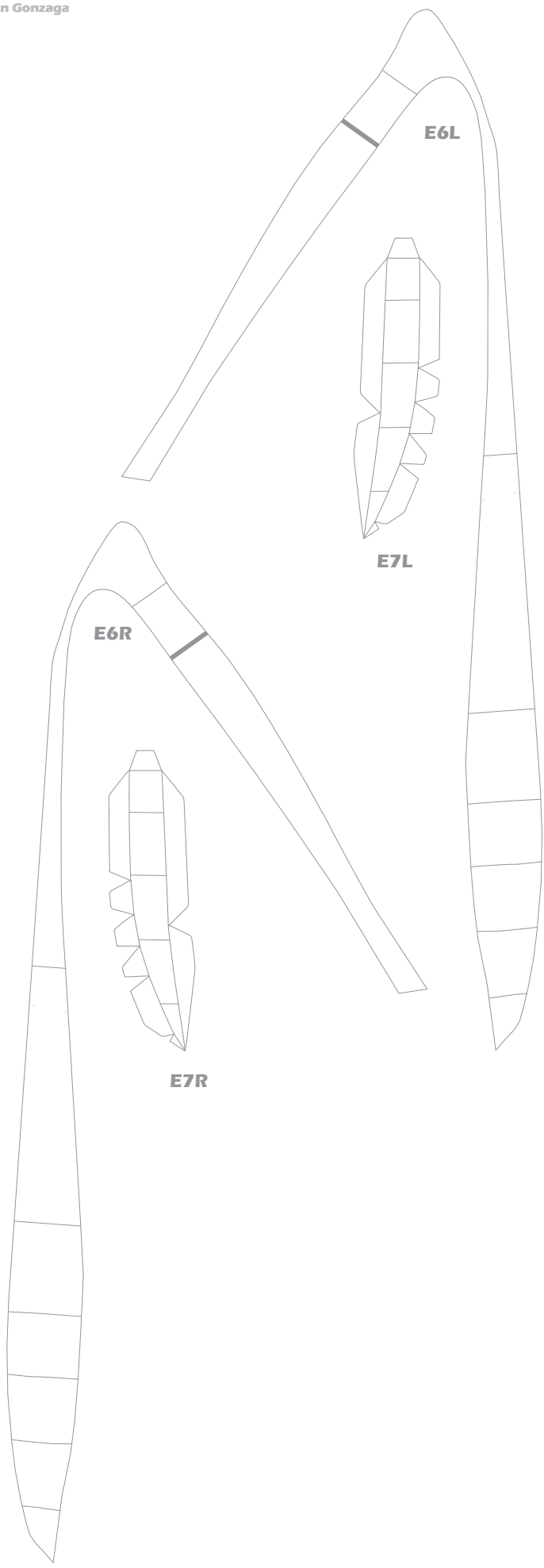

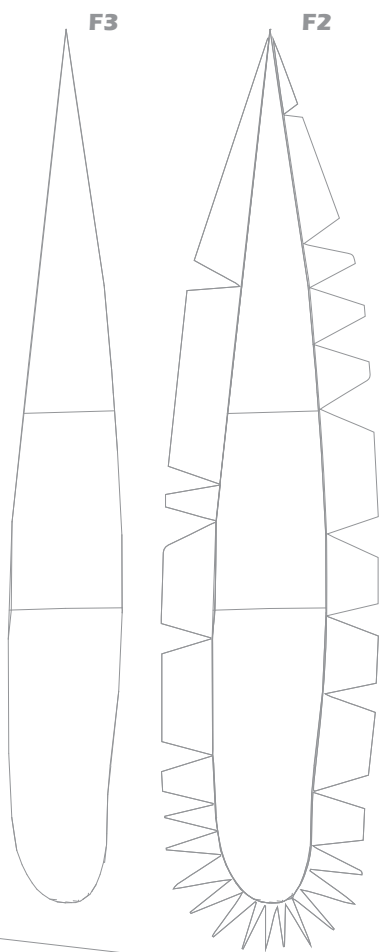
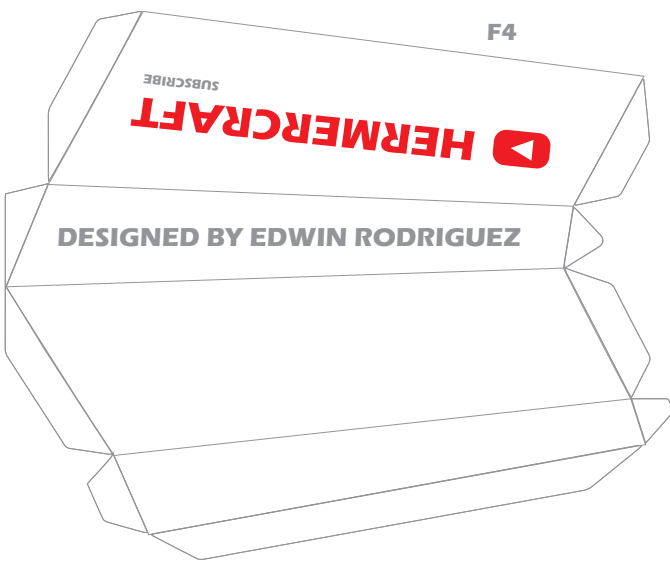
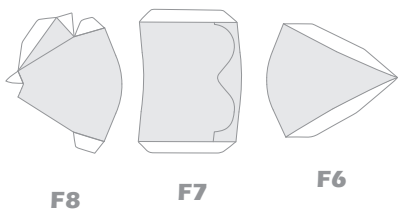
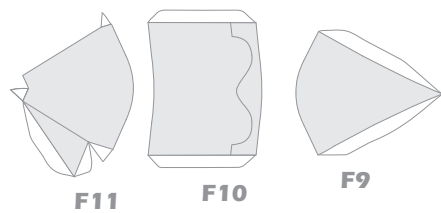
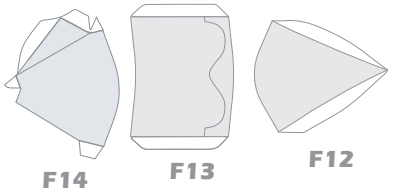
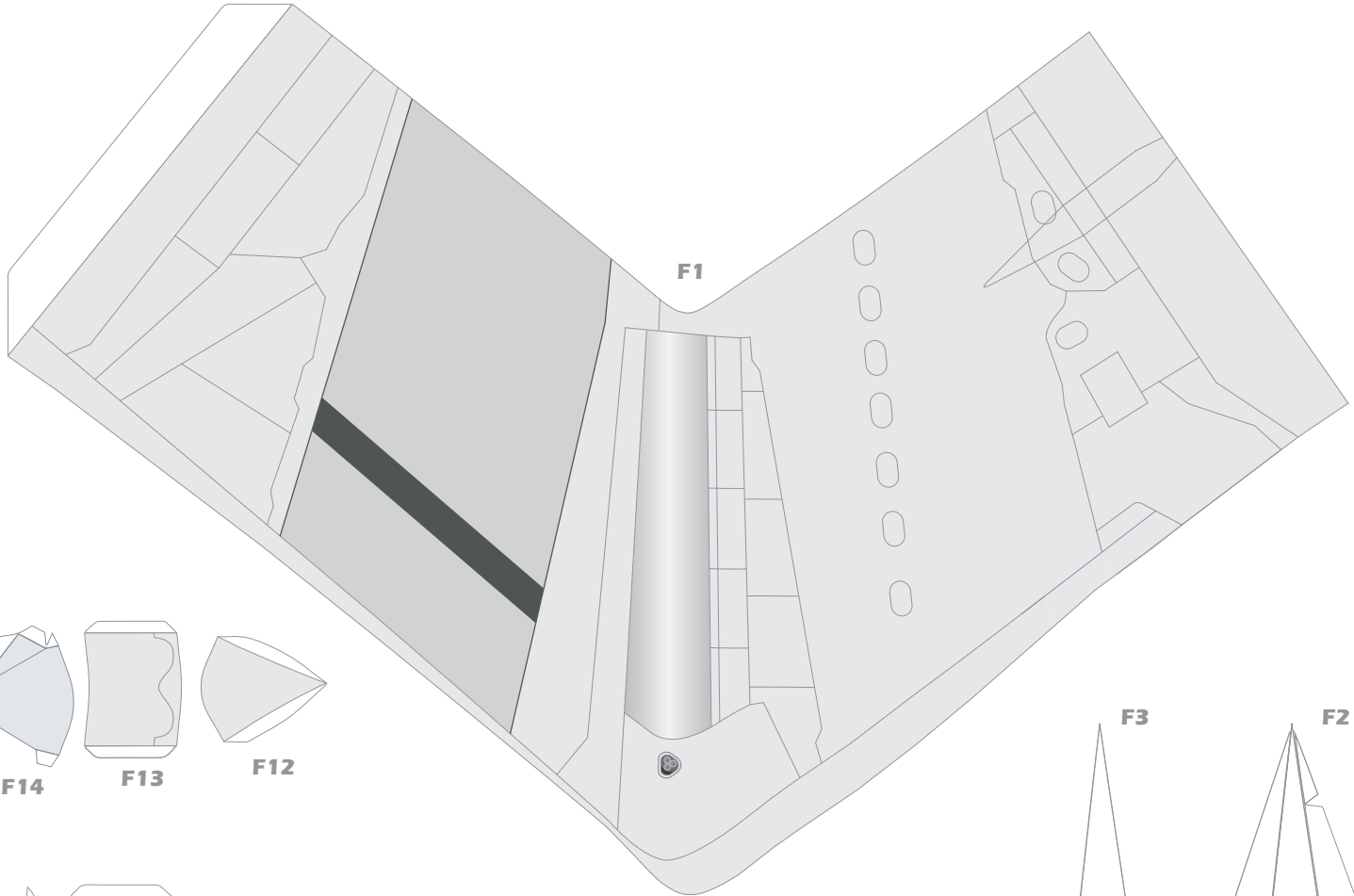

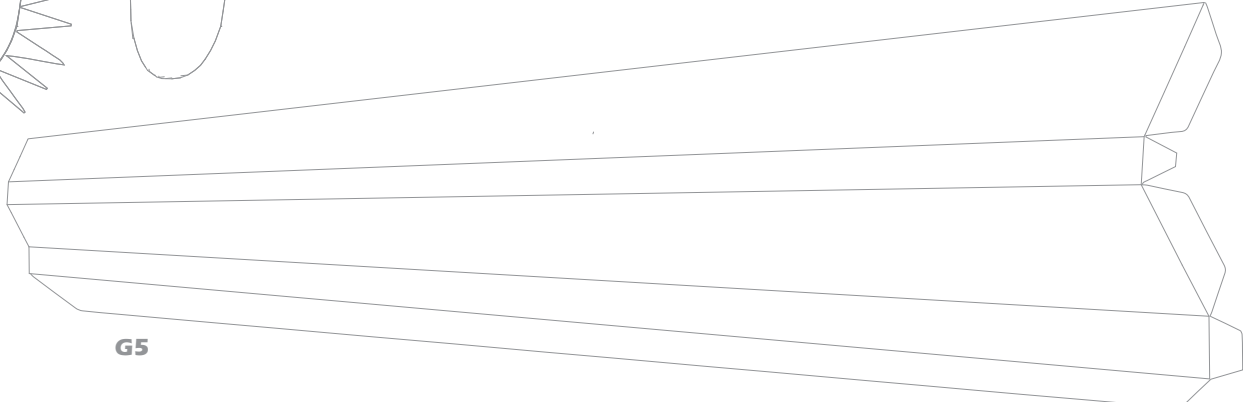
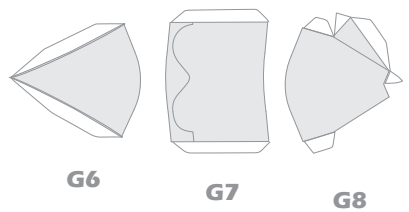
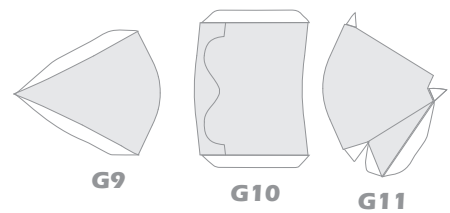
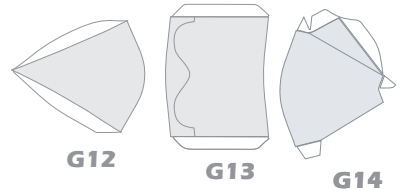
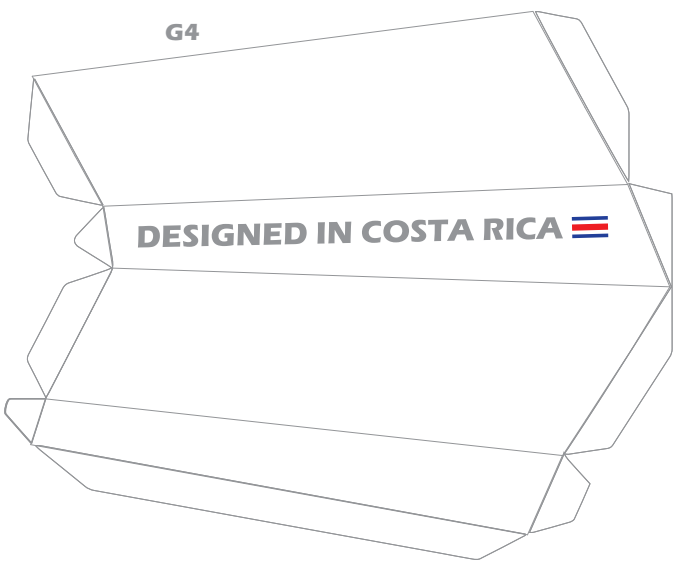
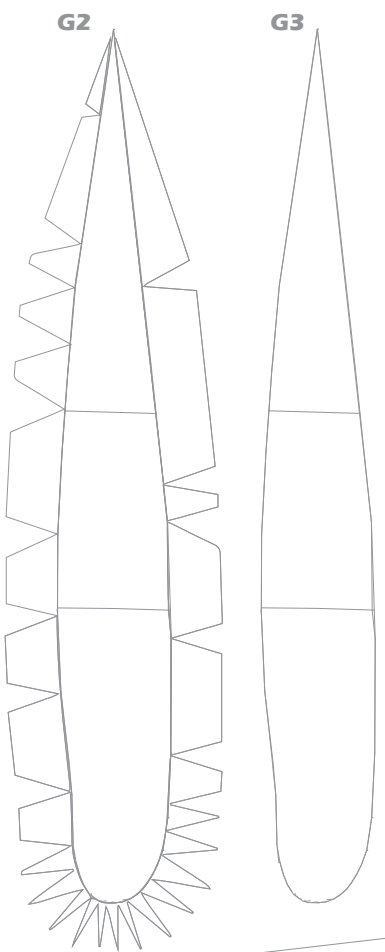
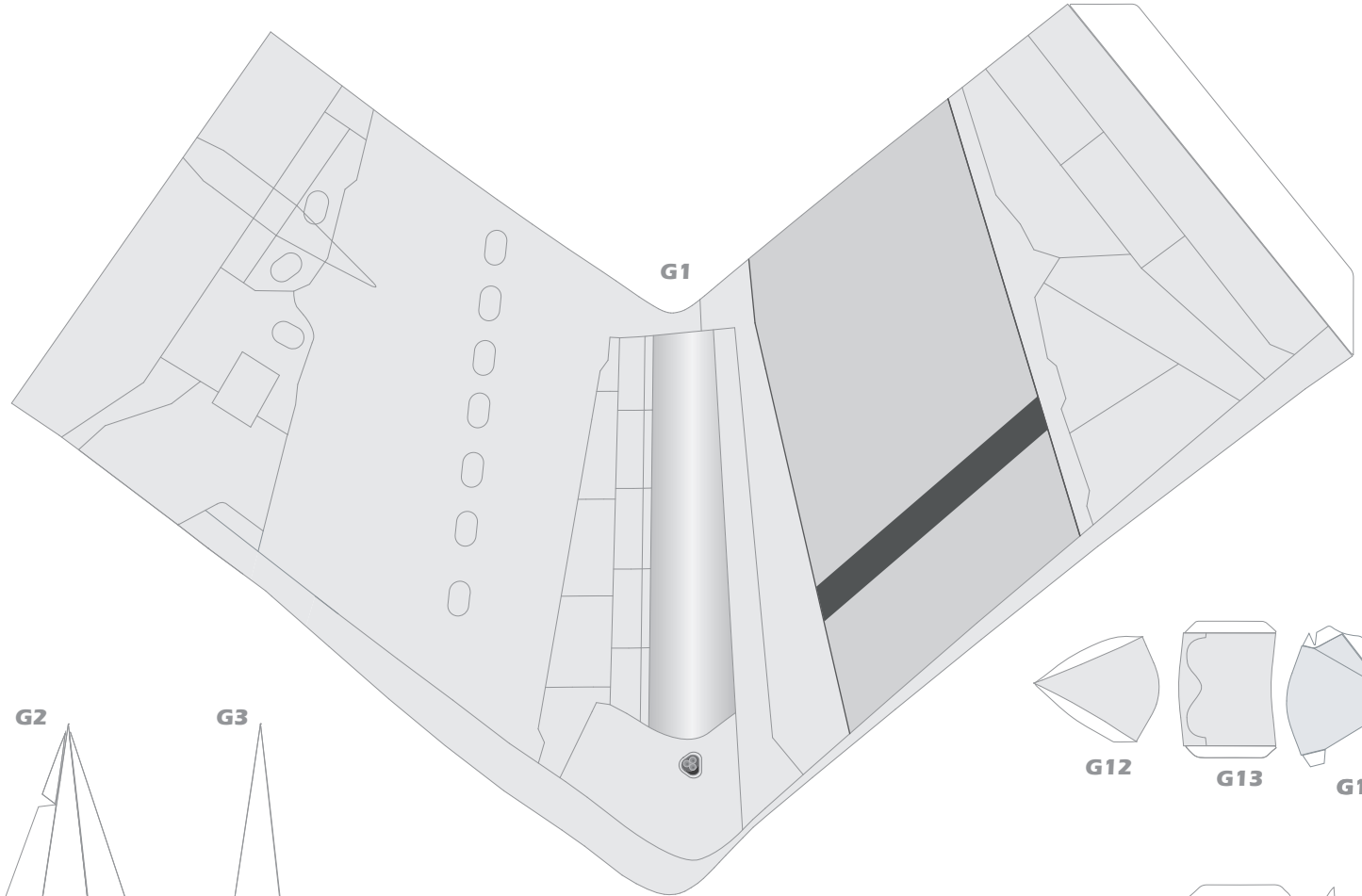

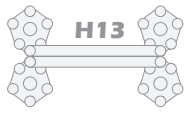
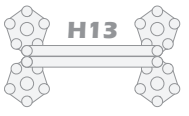
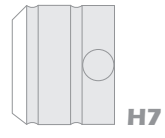
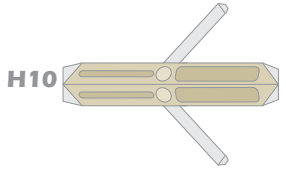
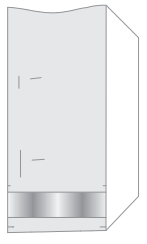
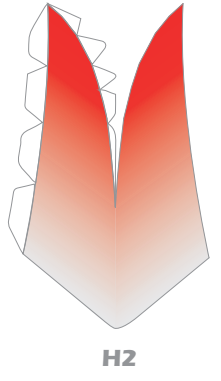
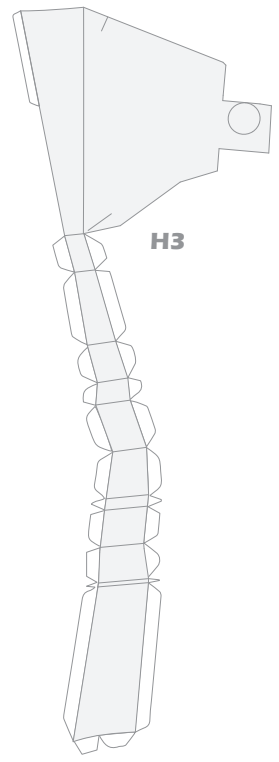
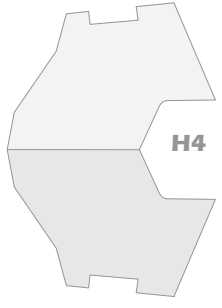
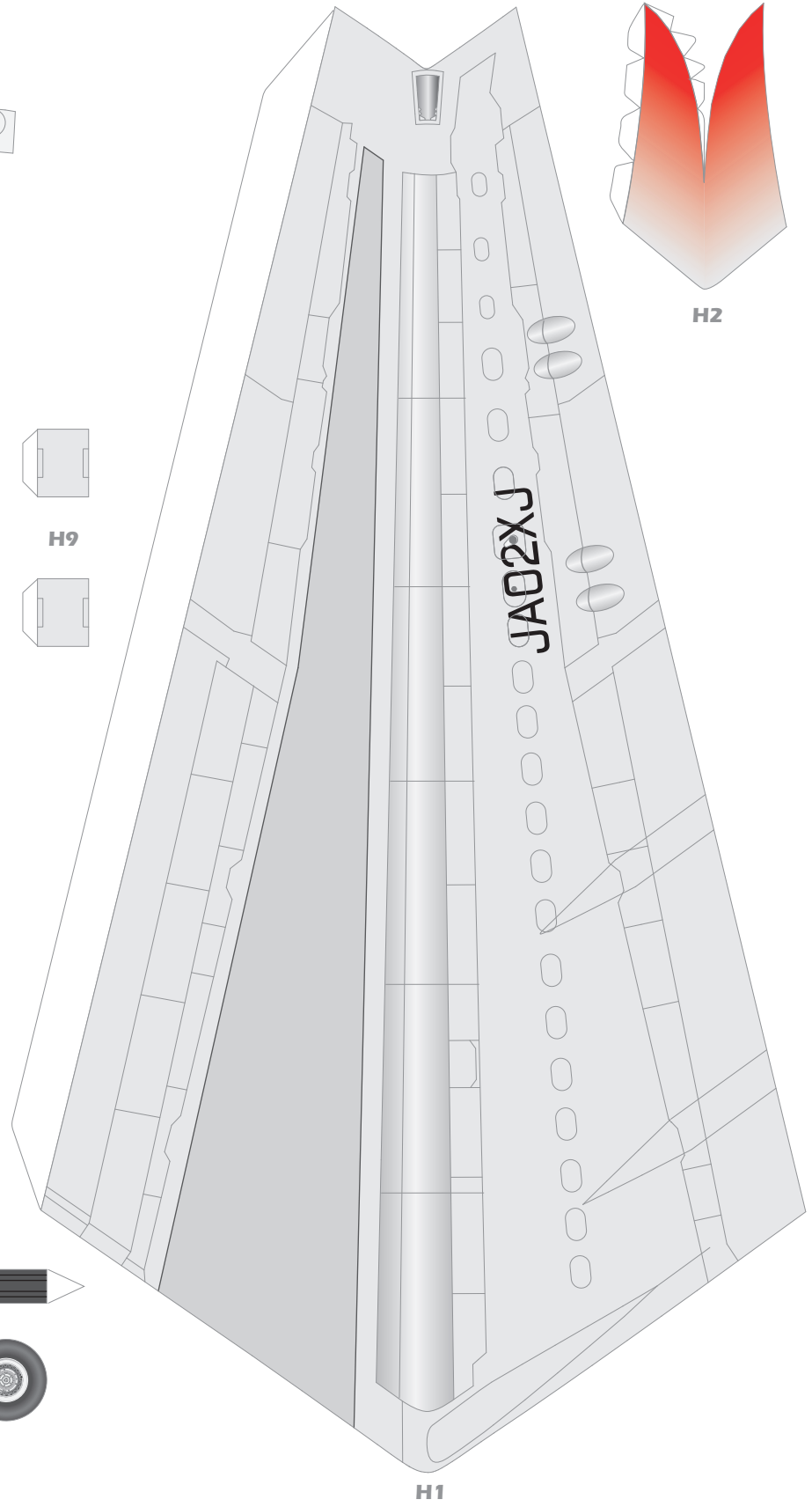

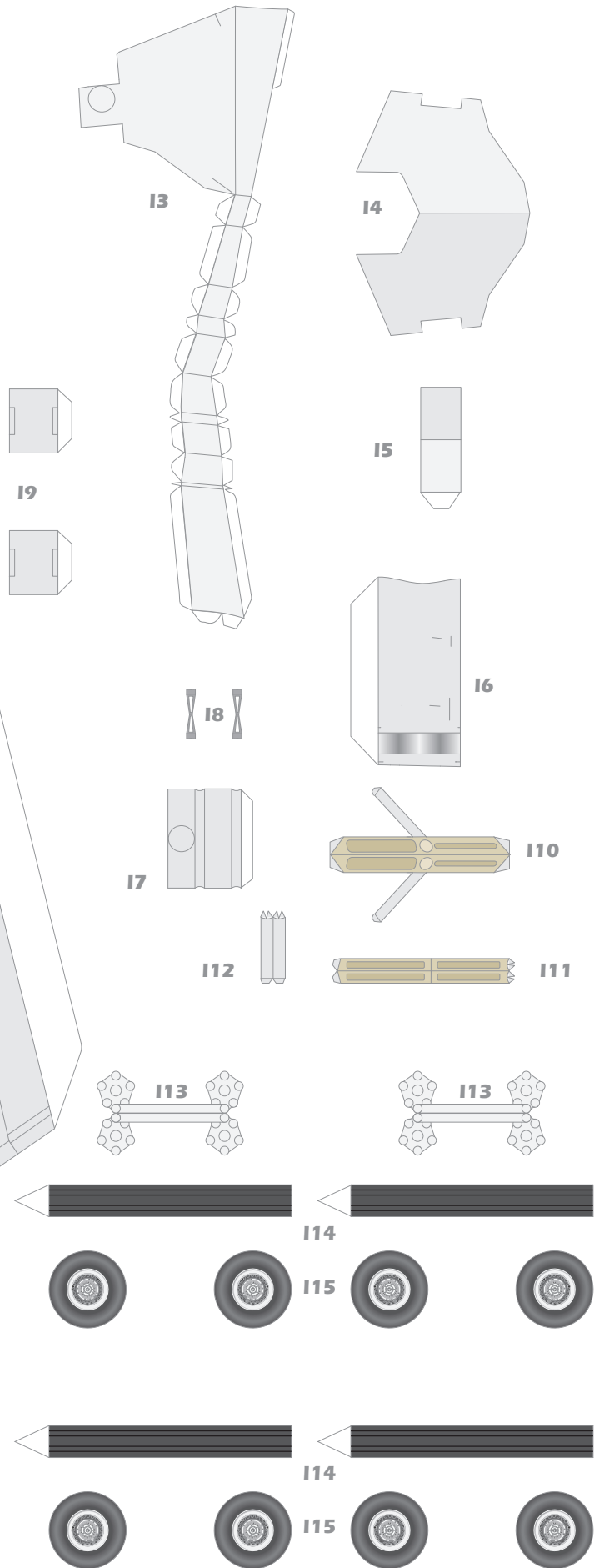
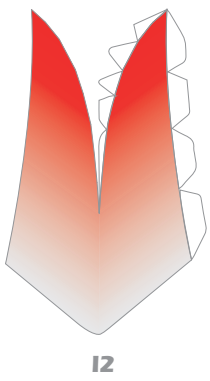
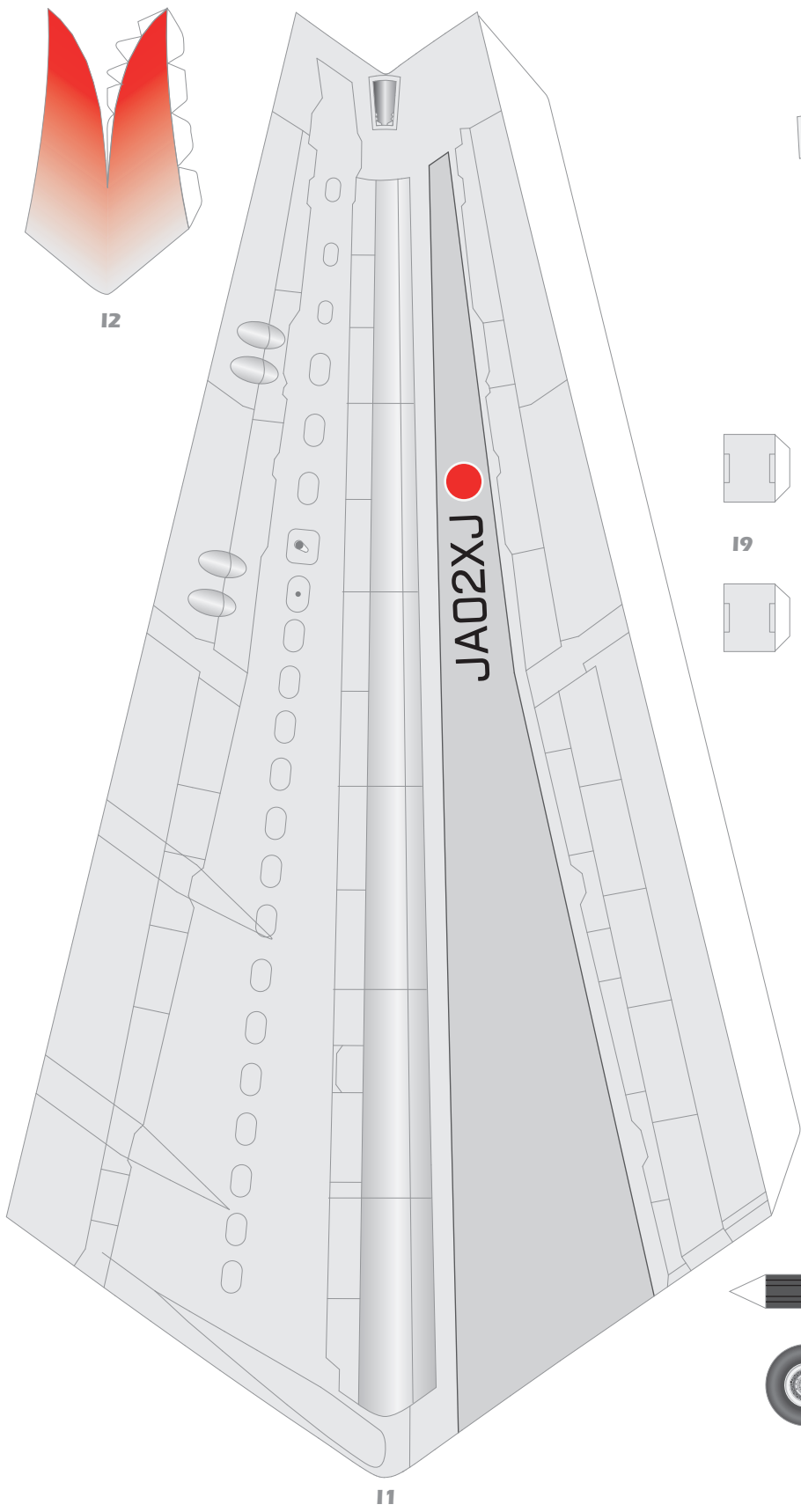

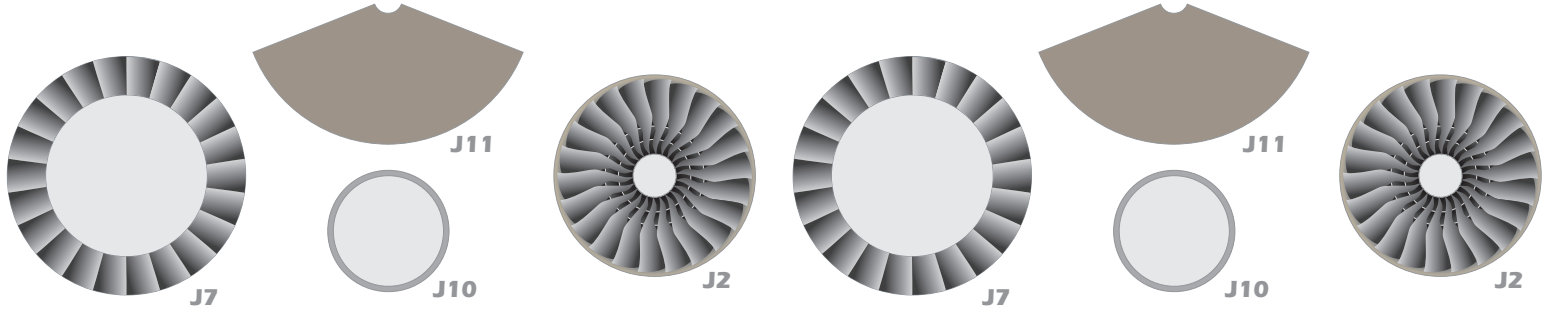
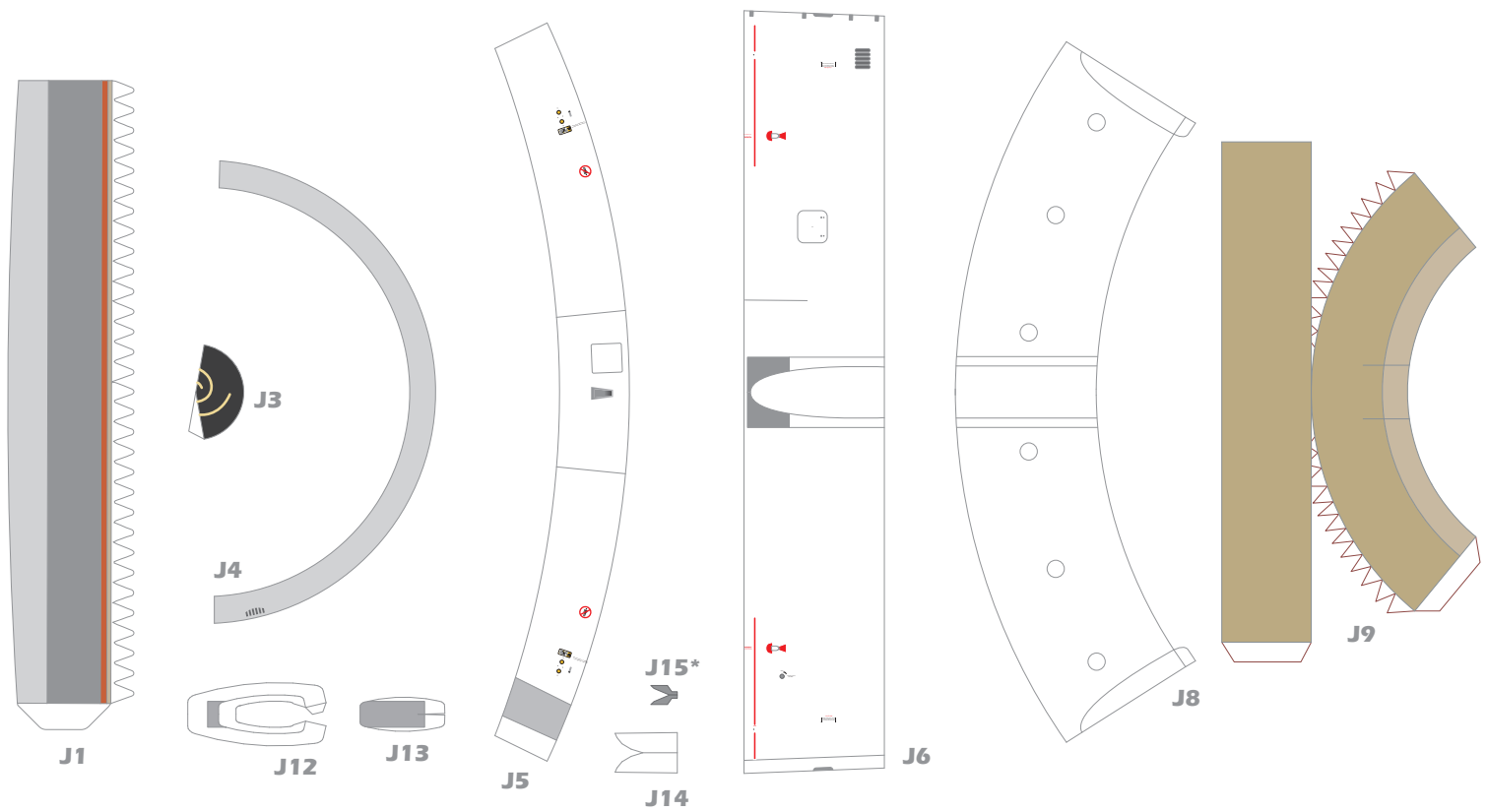
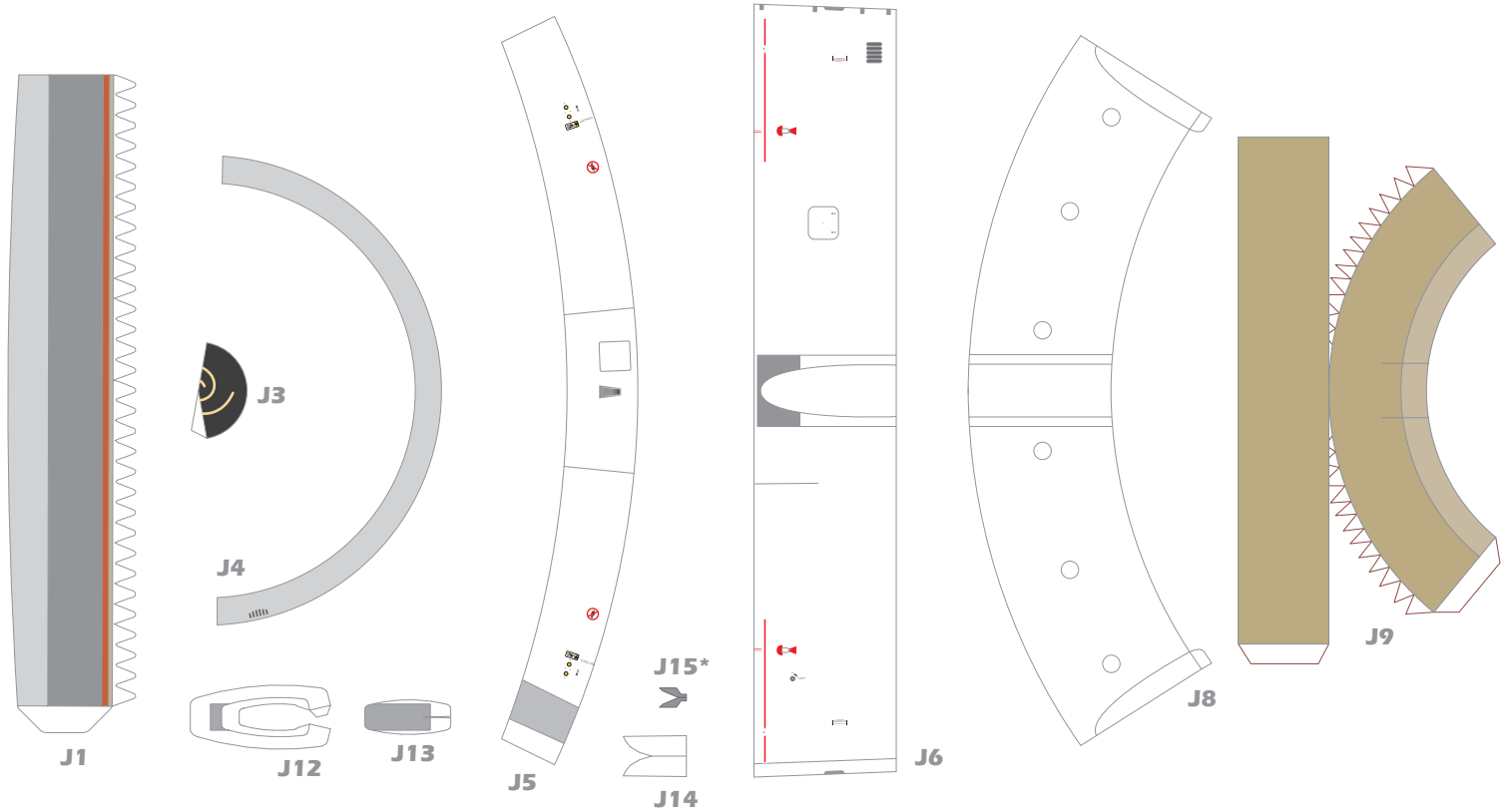

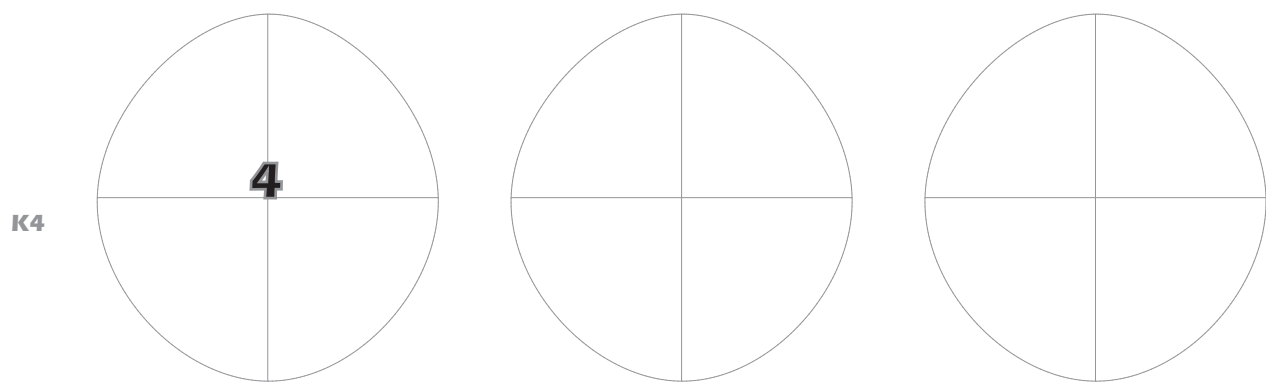
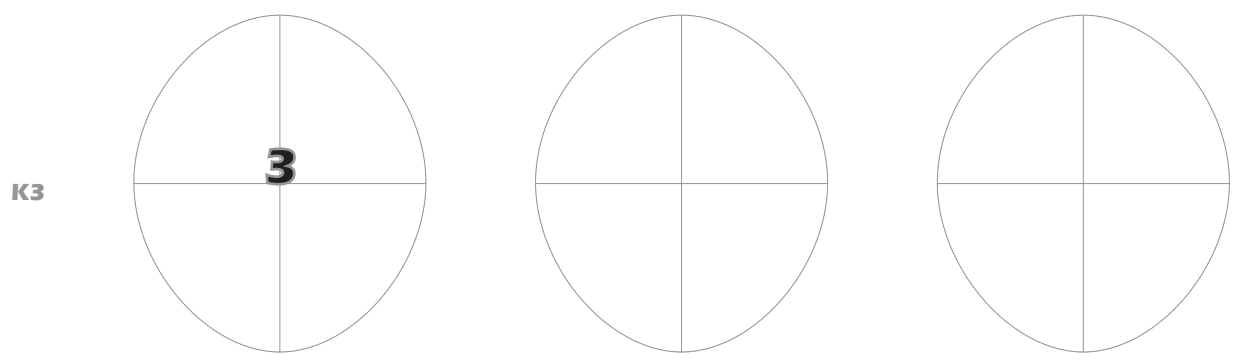
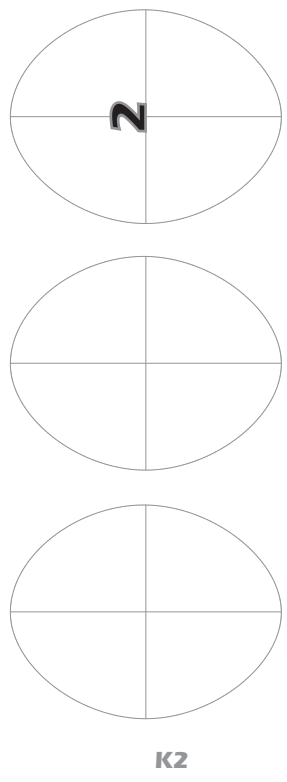
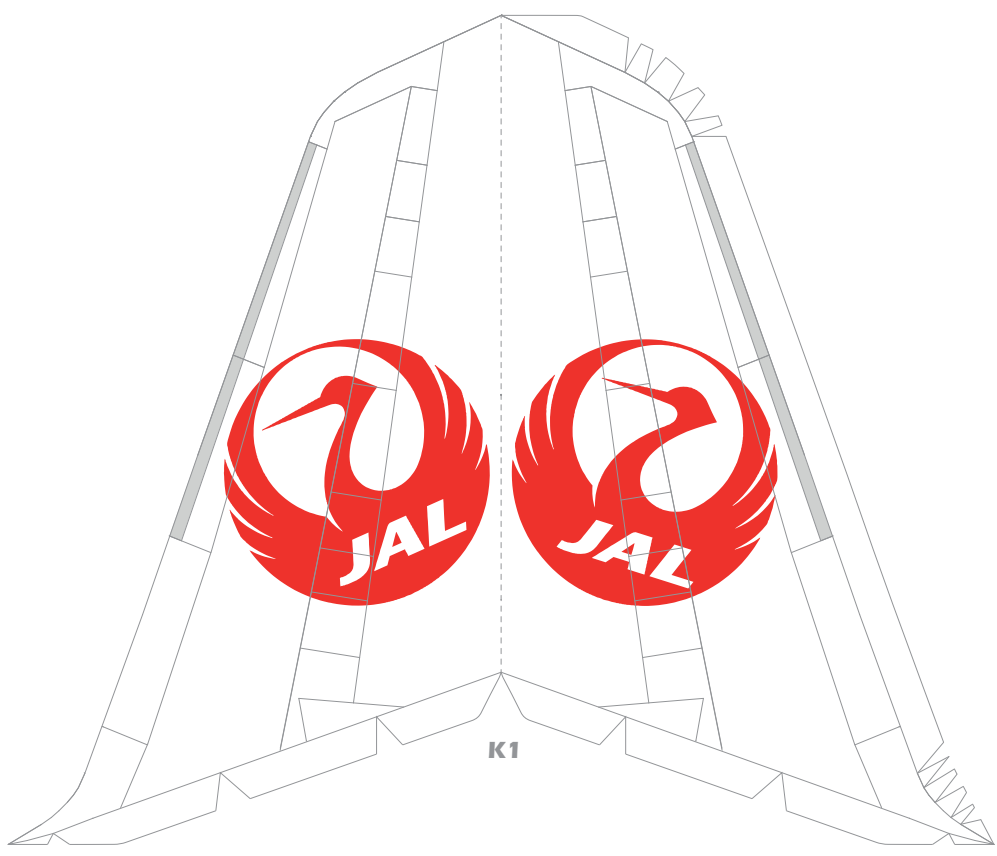

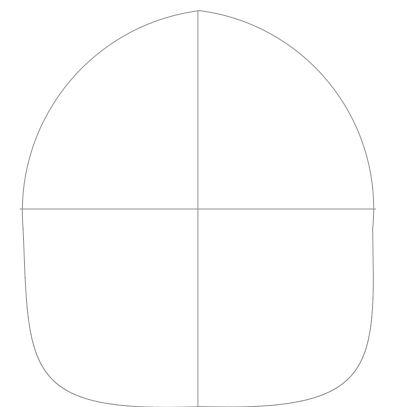
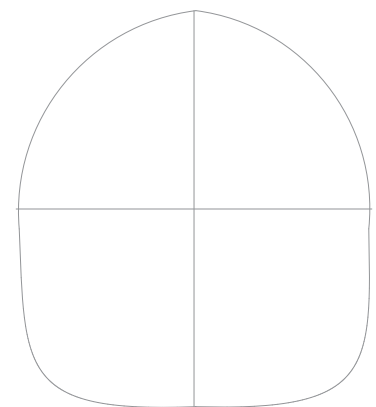
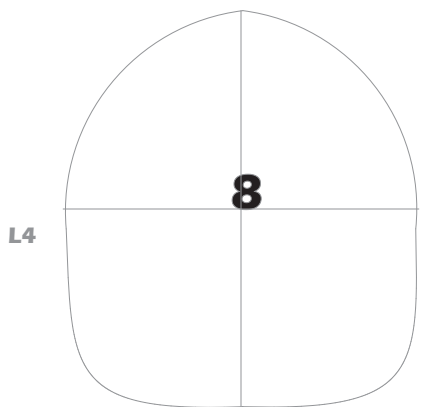
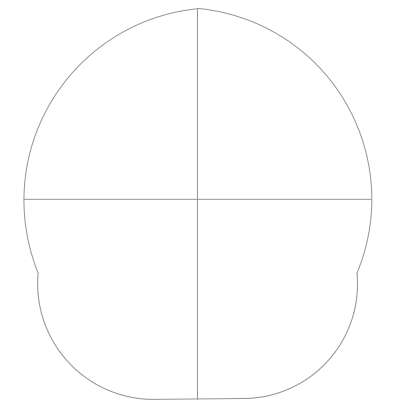
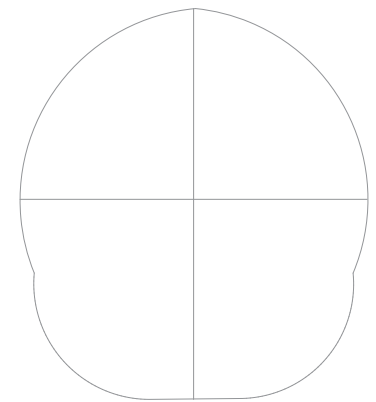
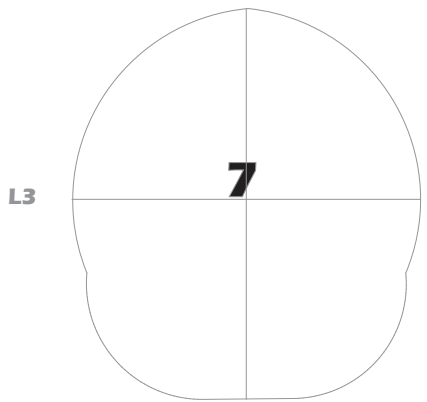
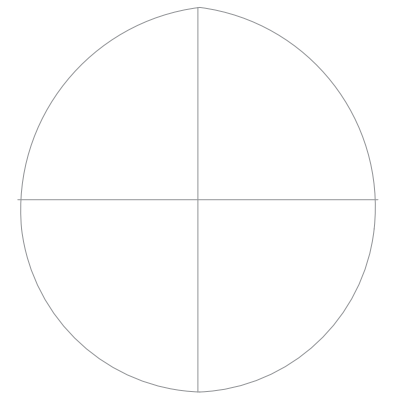
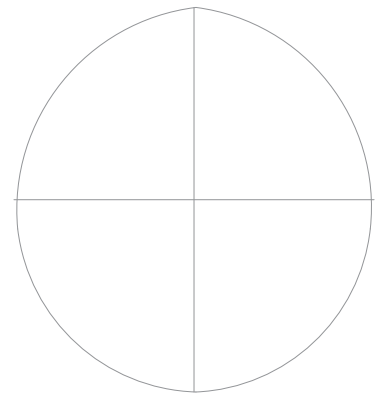
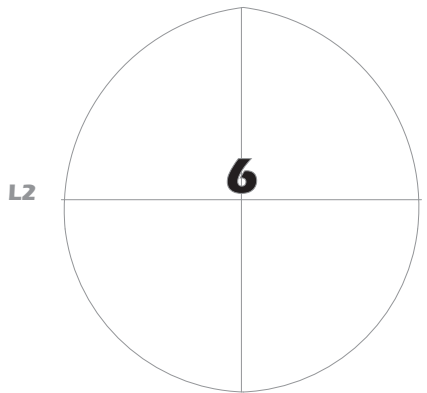
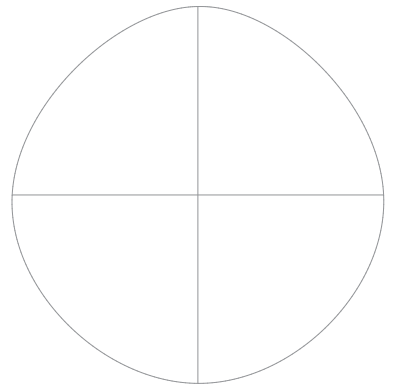
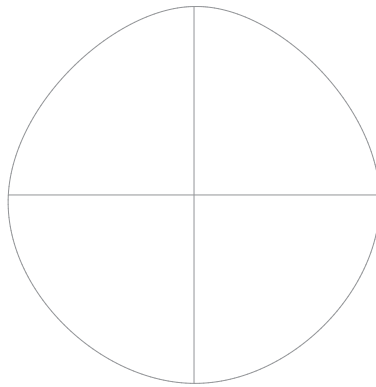
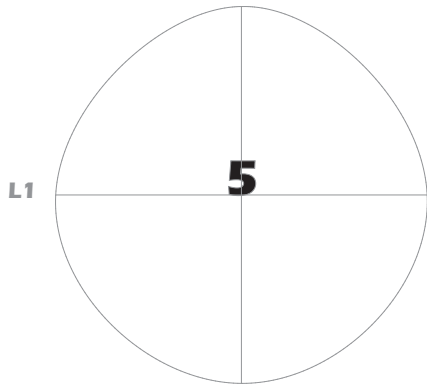

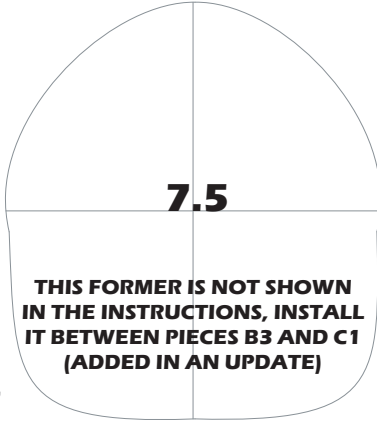

M7

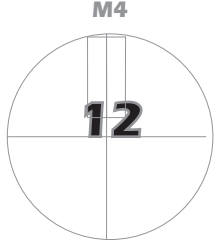
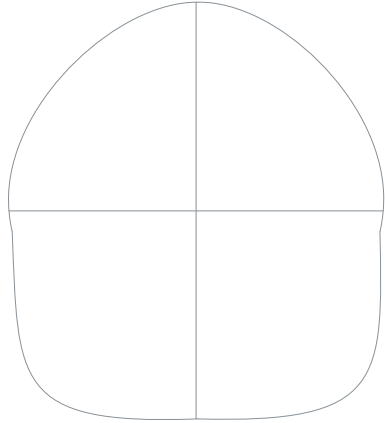
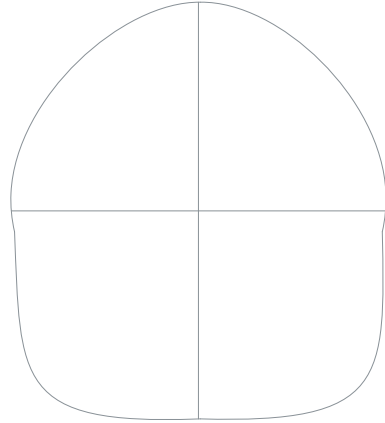

M4

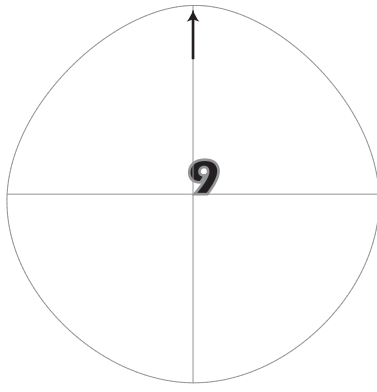
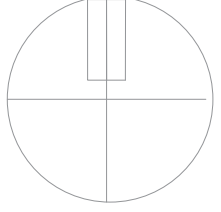

M1

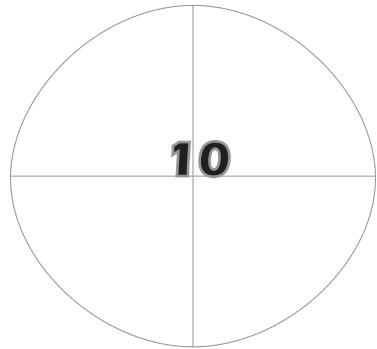
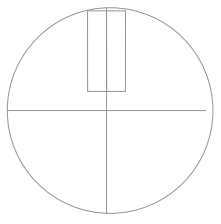
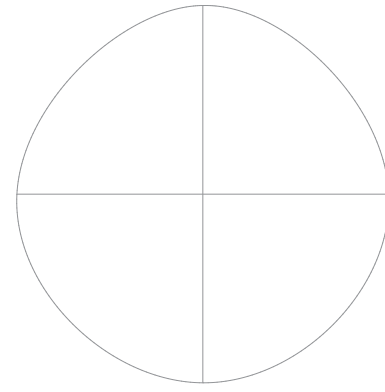
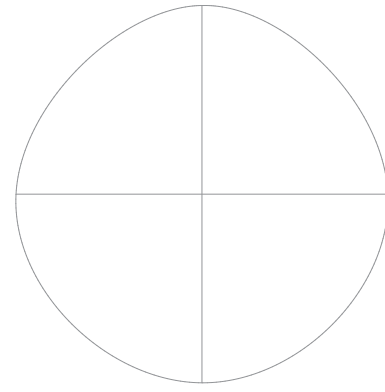

M2

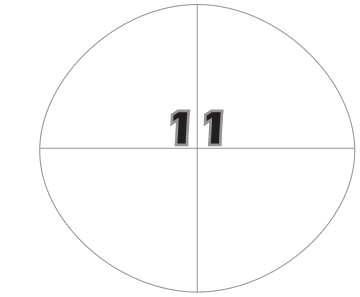
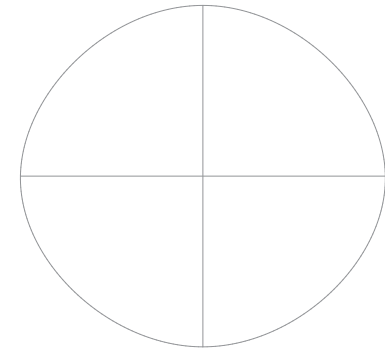
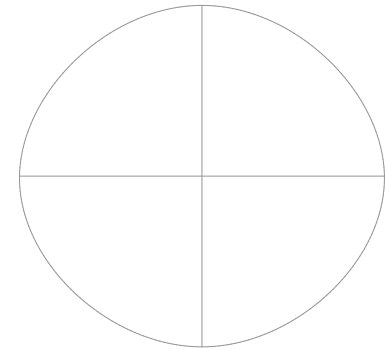

M3

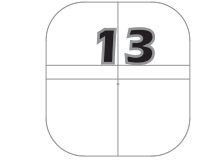
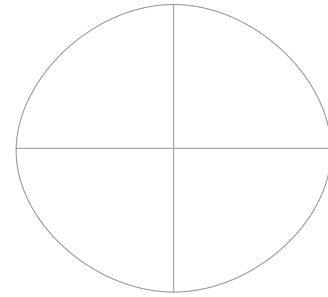
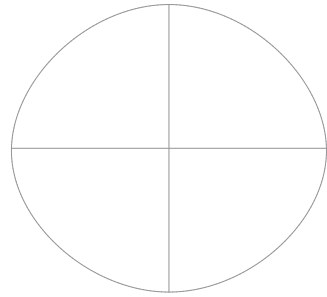

M5

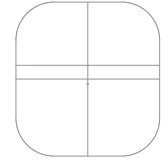
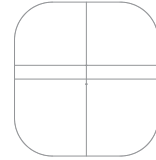

M6

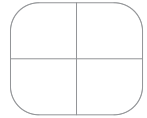
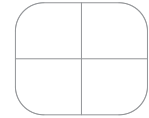

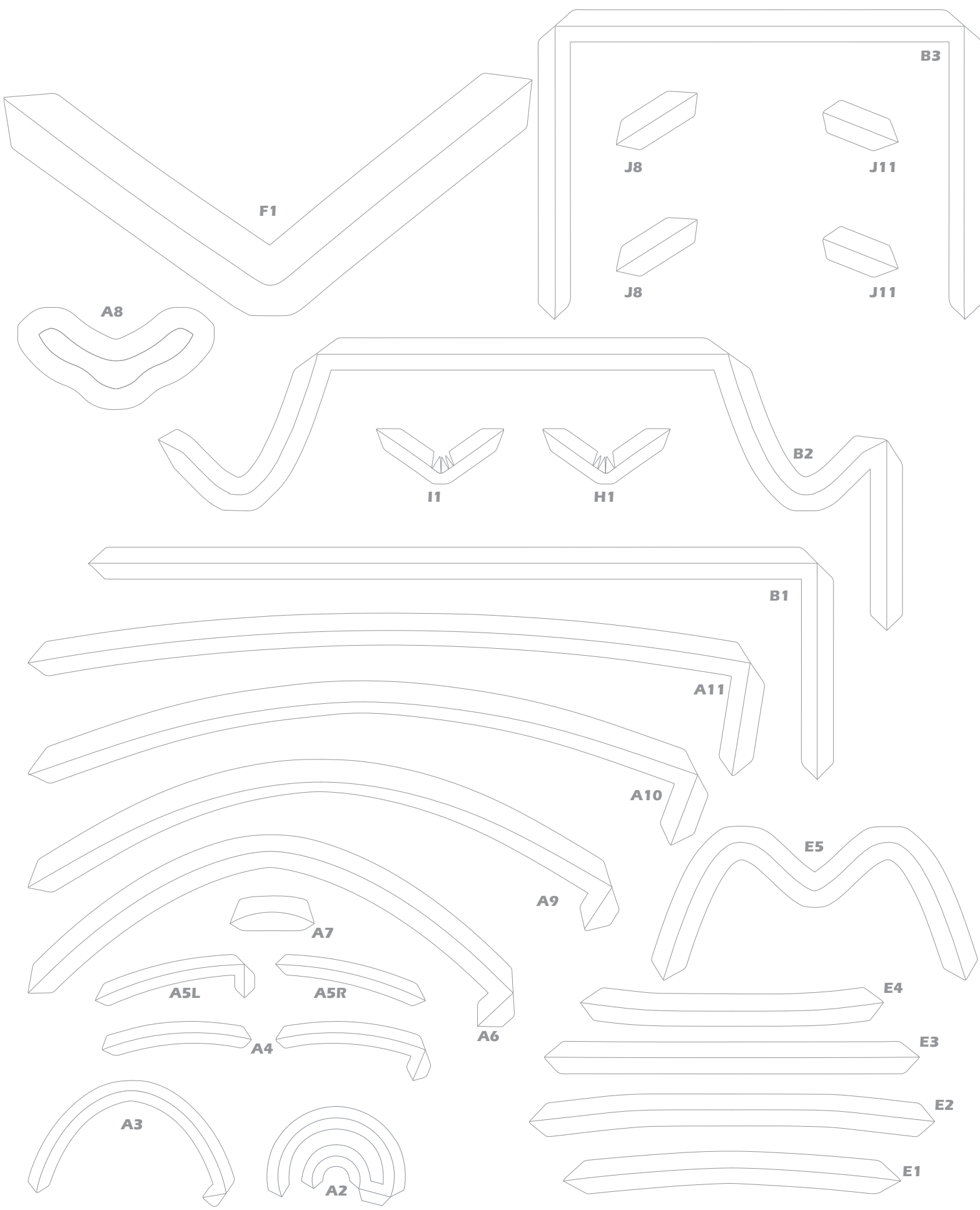

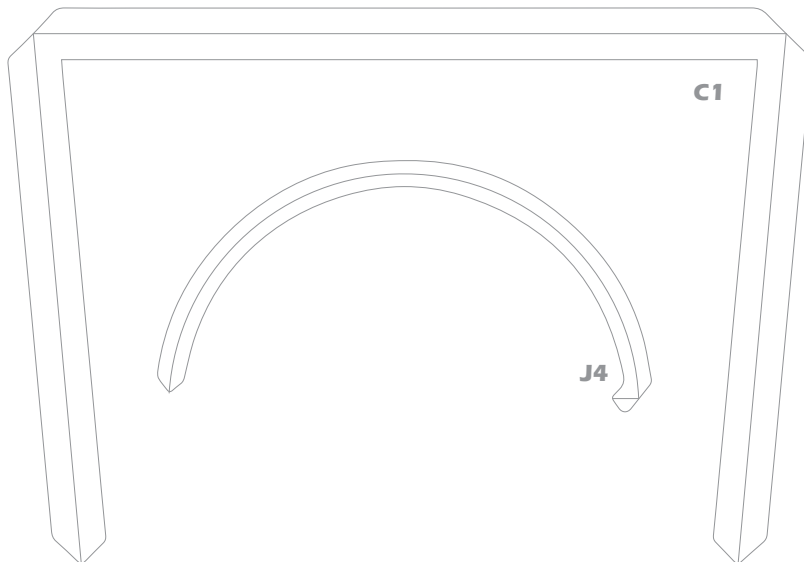
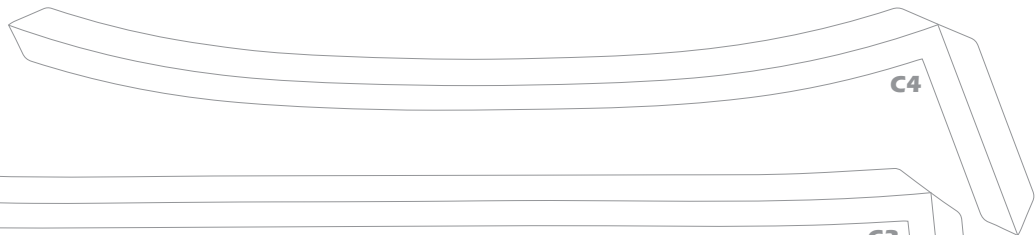
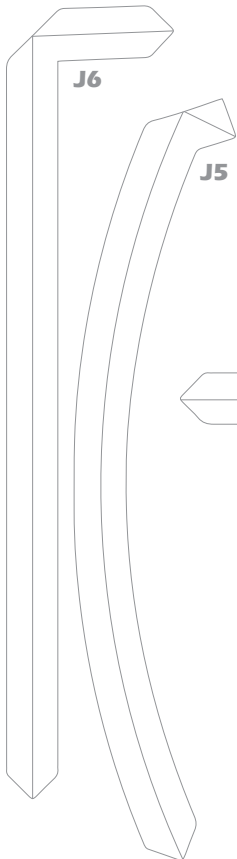
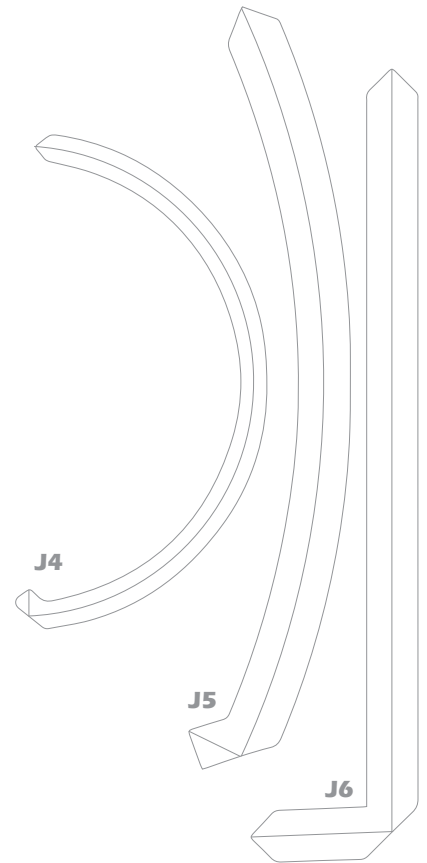
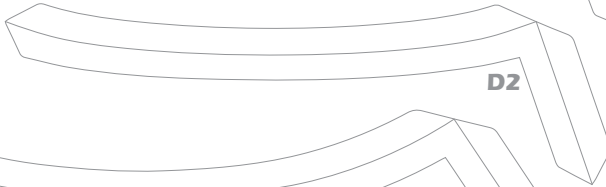
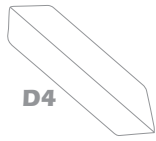
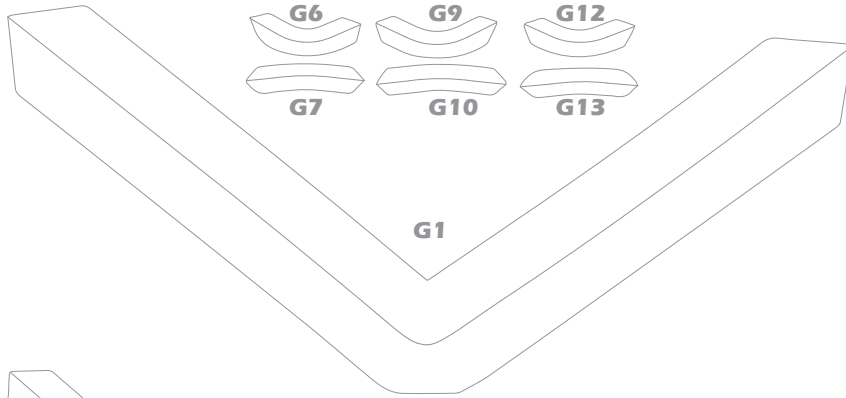
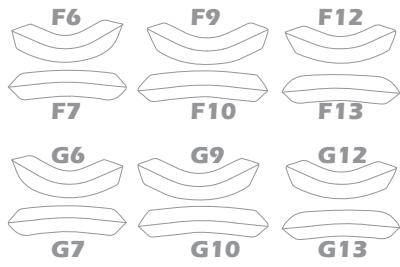

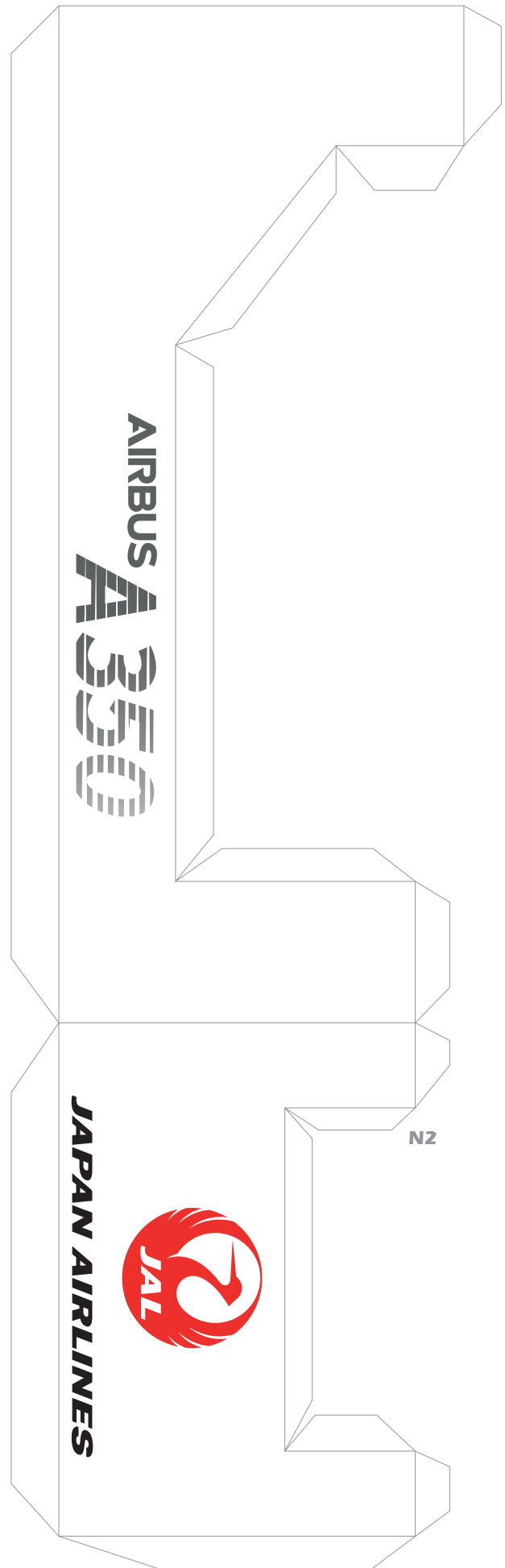
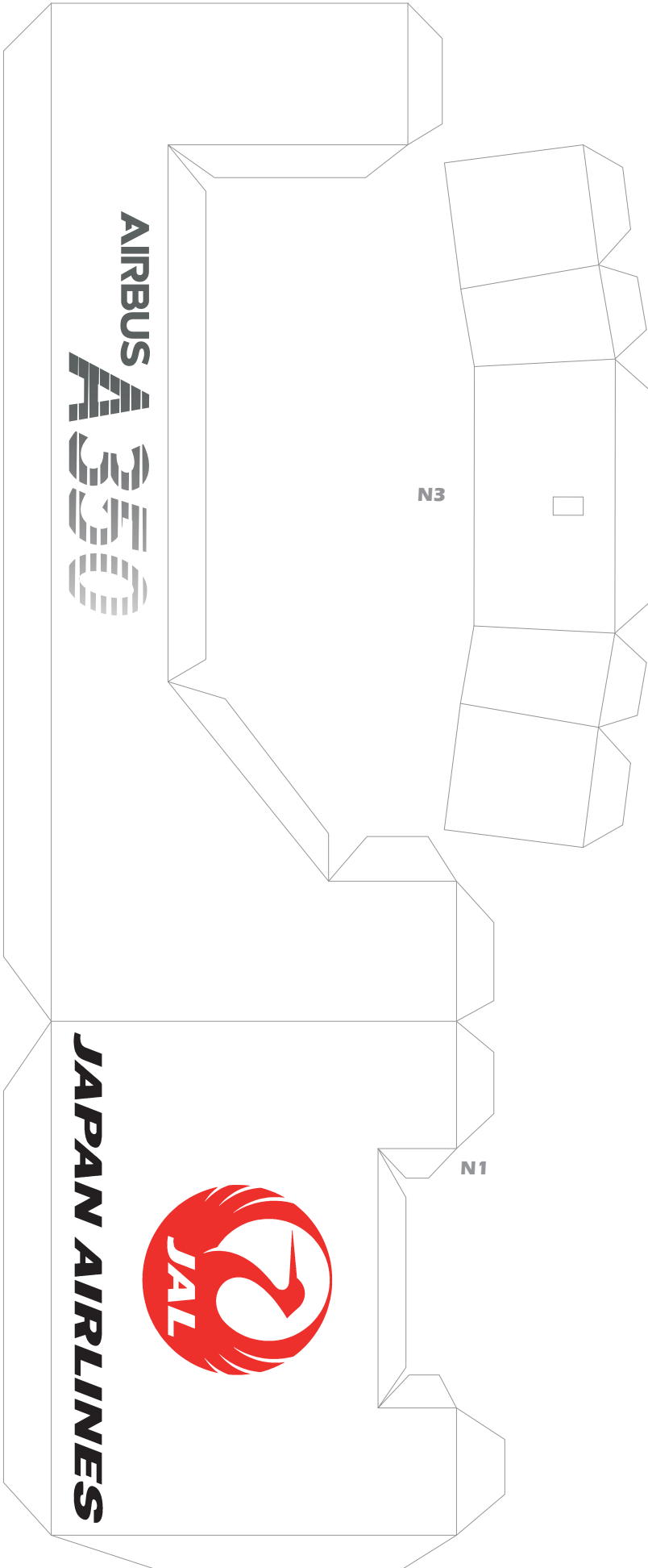

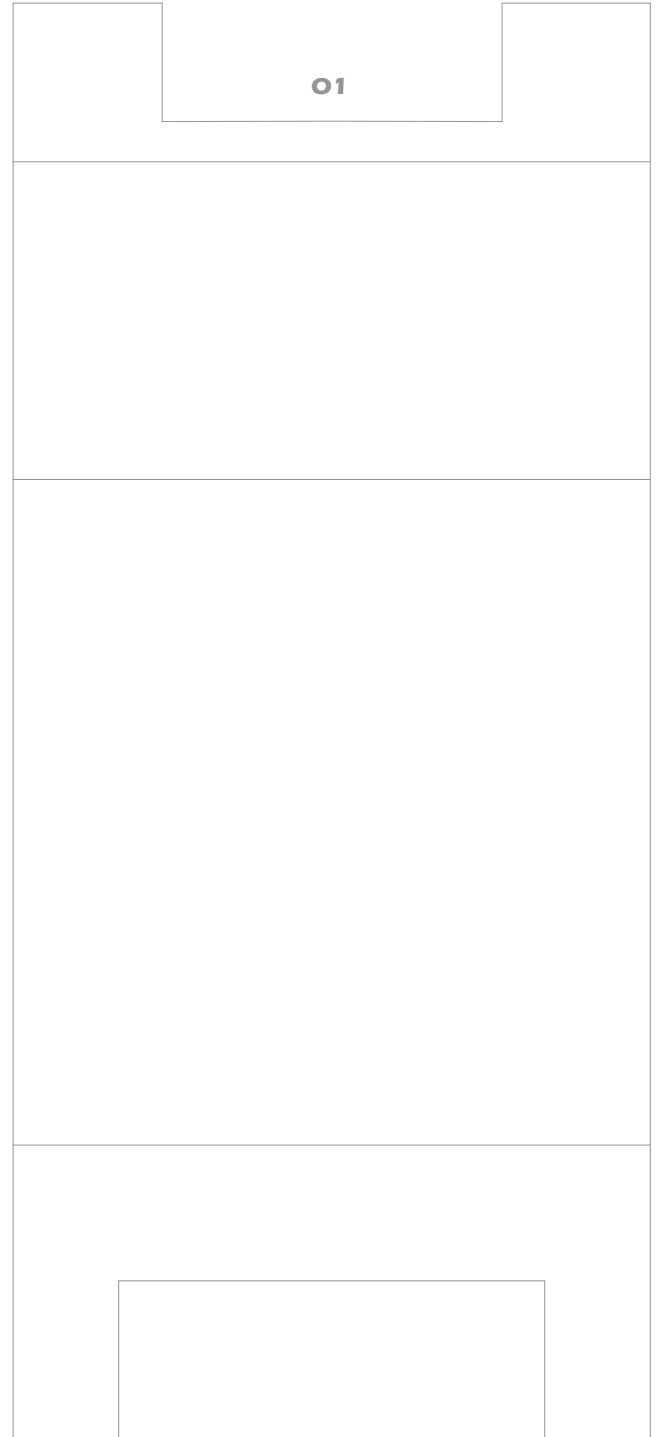

O3

PLEASE DO NOT SELL THIS FILE | DESIGNED IN PALMARES, COSTA RICA

HERMERCRAFT

ORIGINAL MODEL DESIGNED BY EDWIN RODRIGUEZ