

Blank space for 787-10 variant

Instructions



Scan

A14

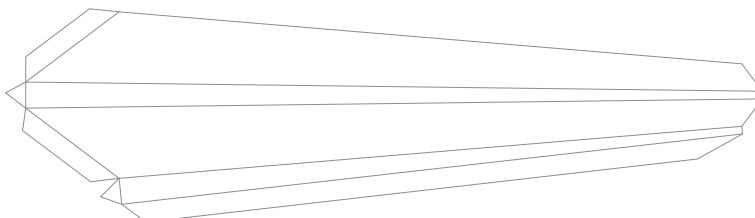

A16L

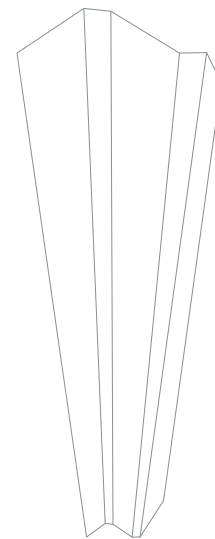

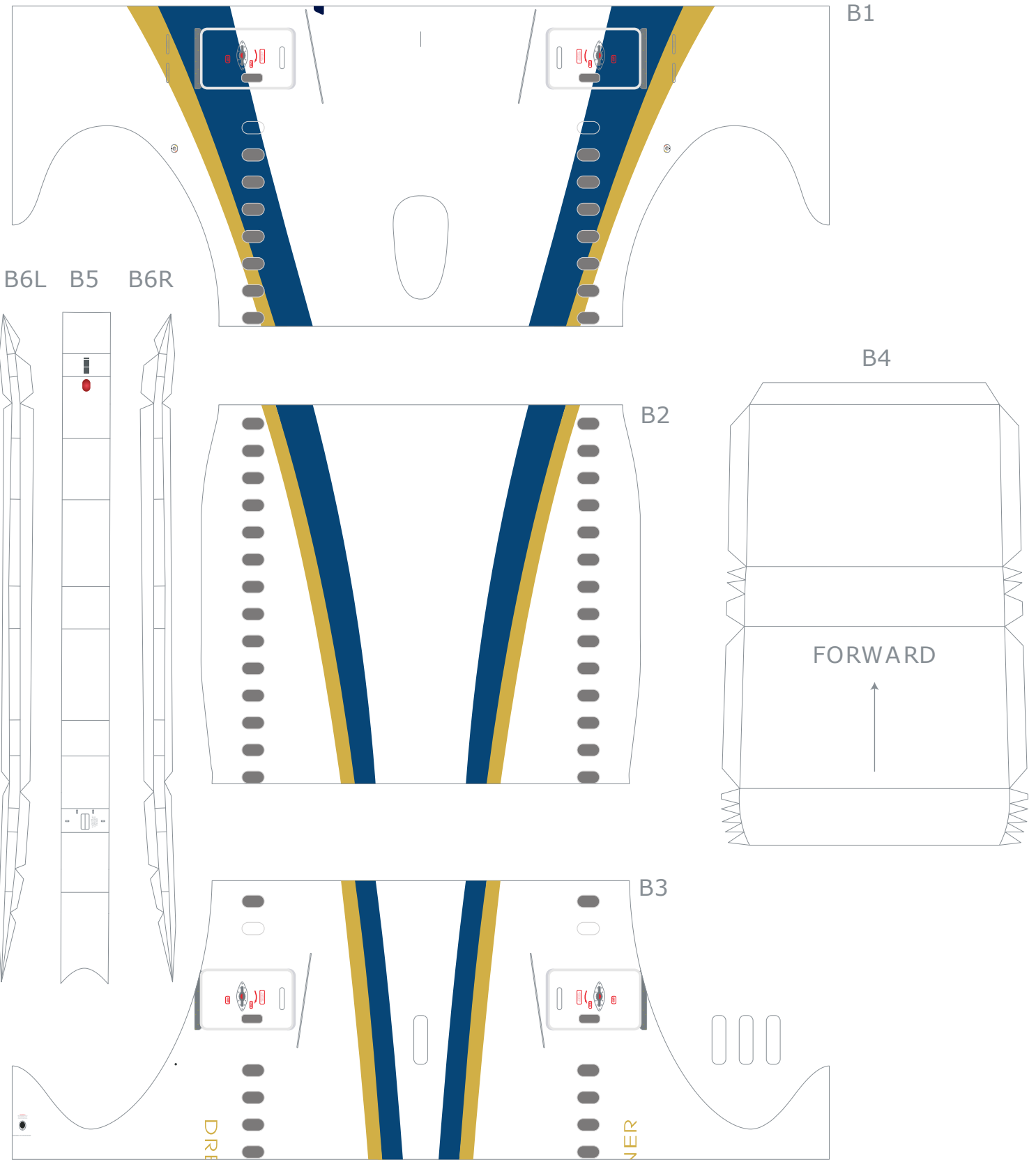

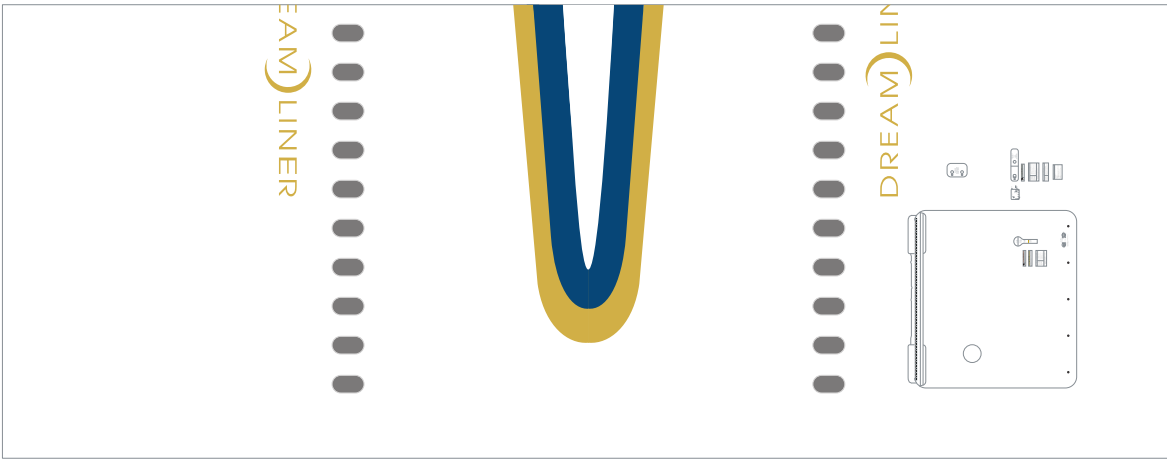

Blank space for 787-10 variant

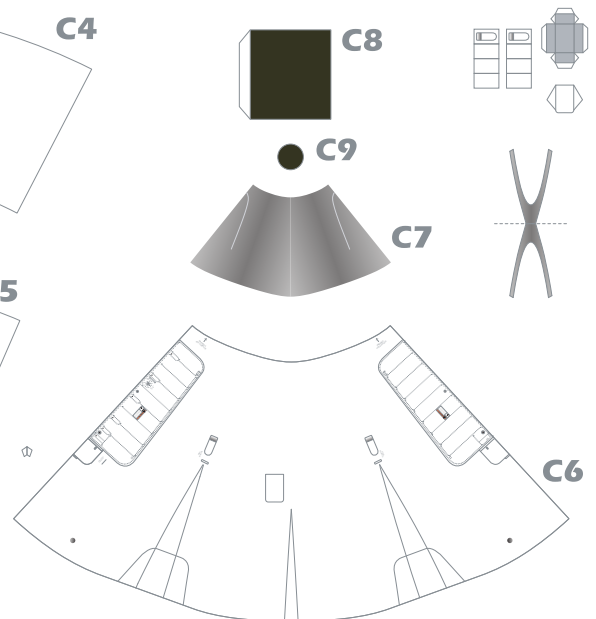
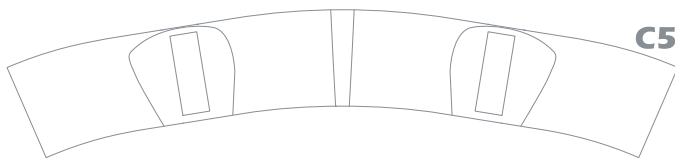
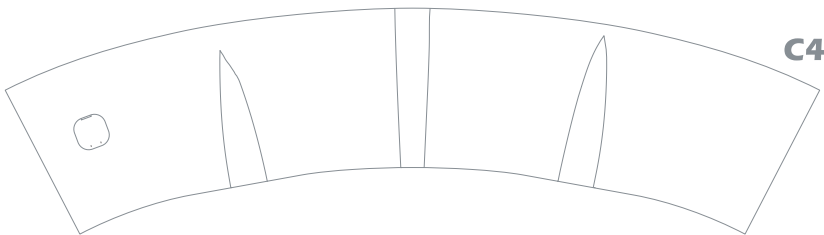
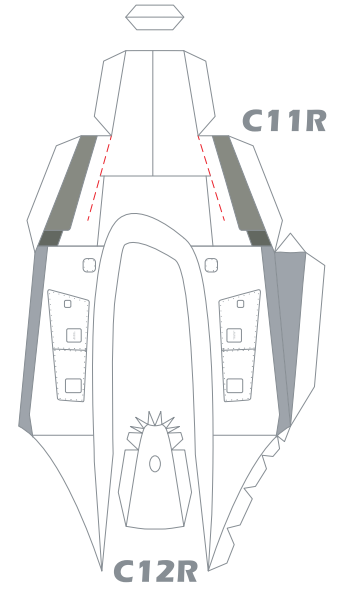
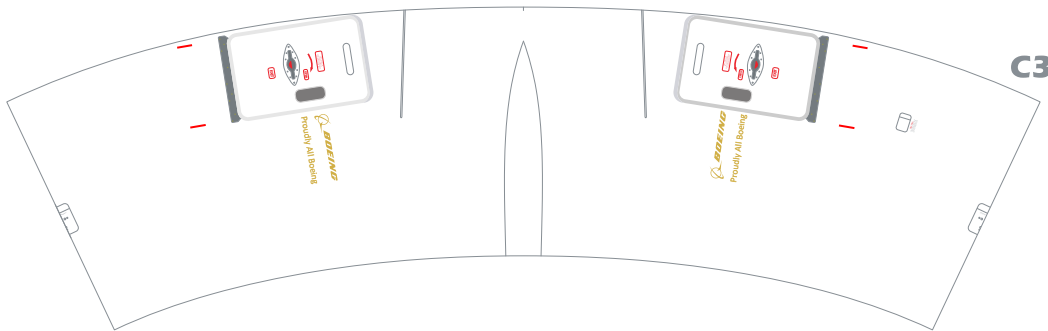
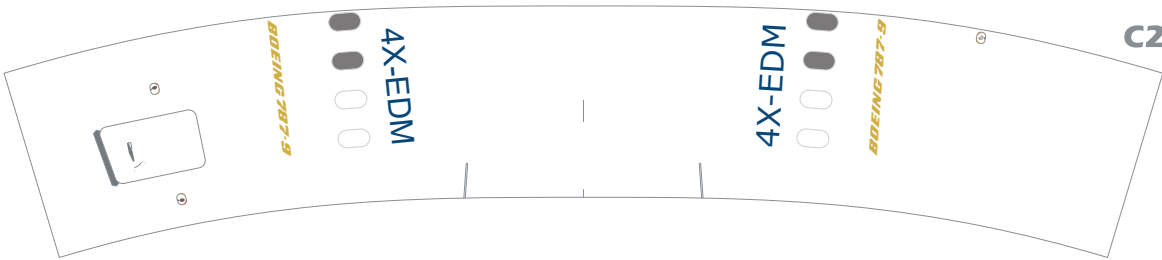
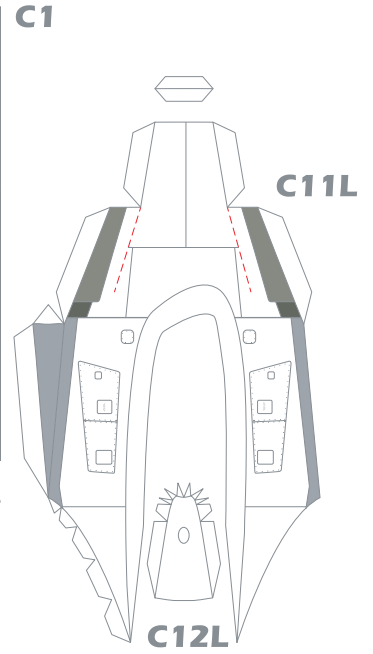

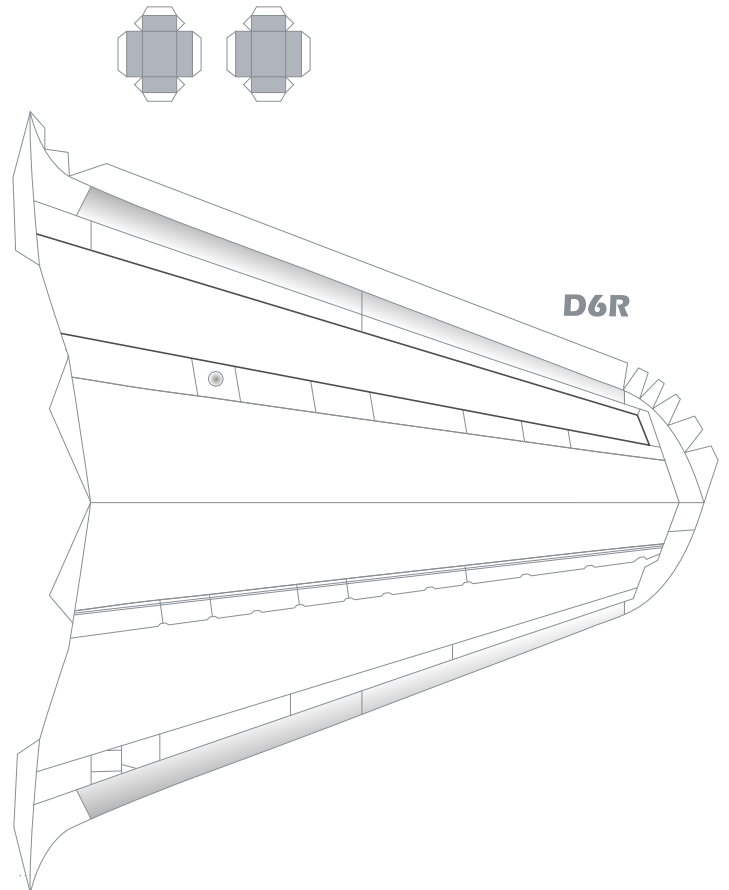
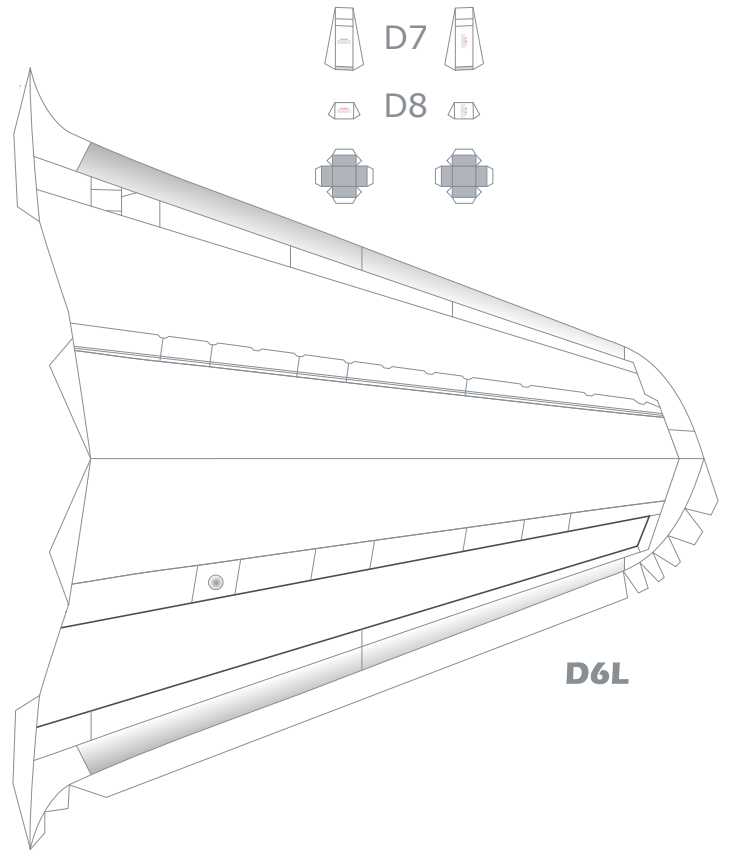
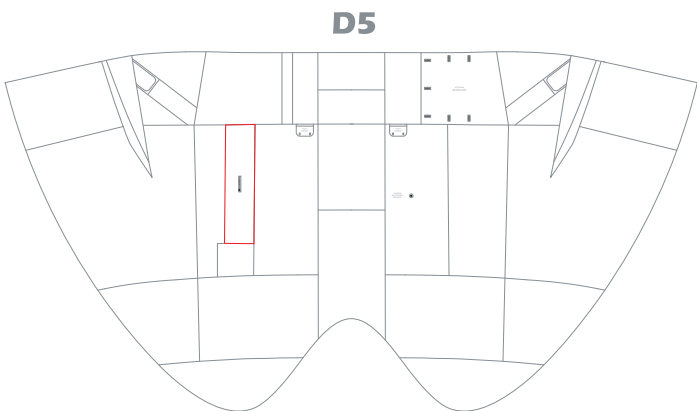
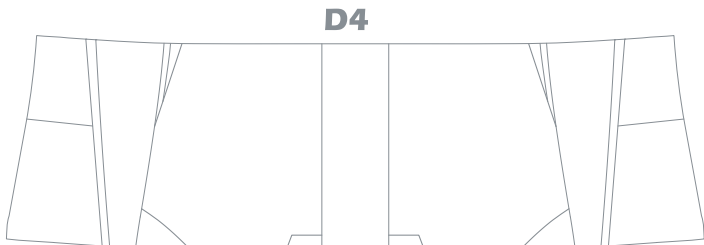
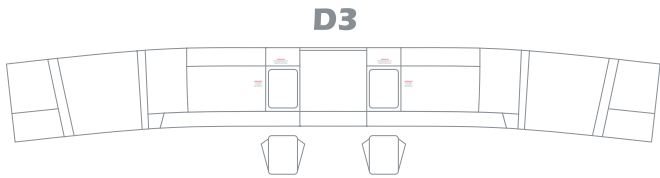
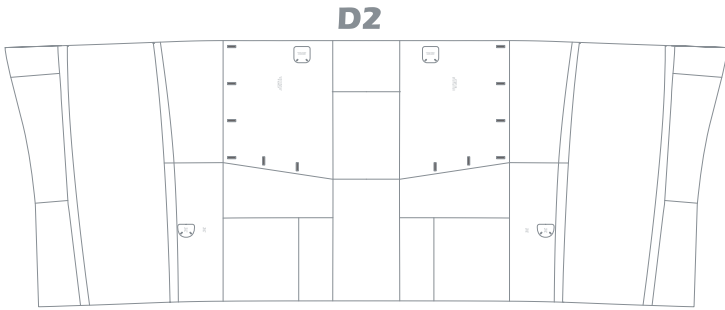
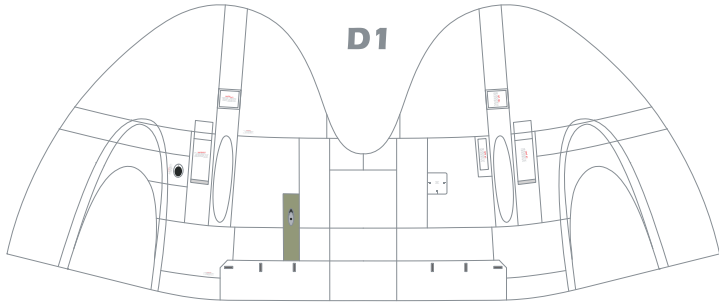

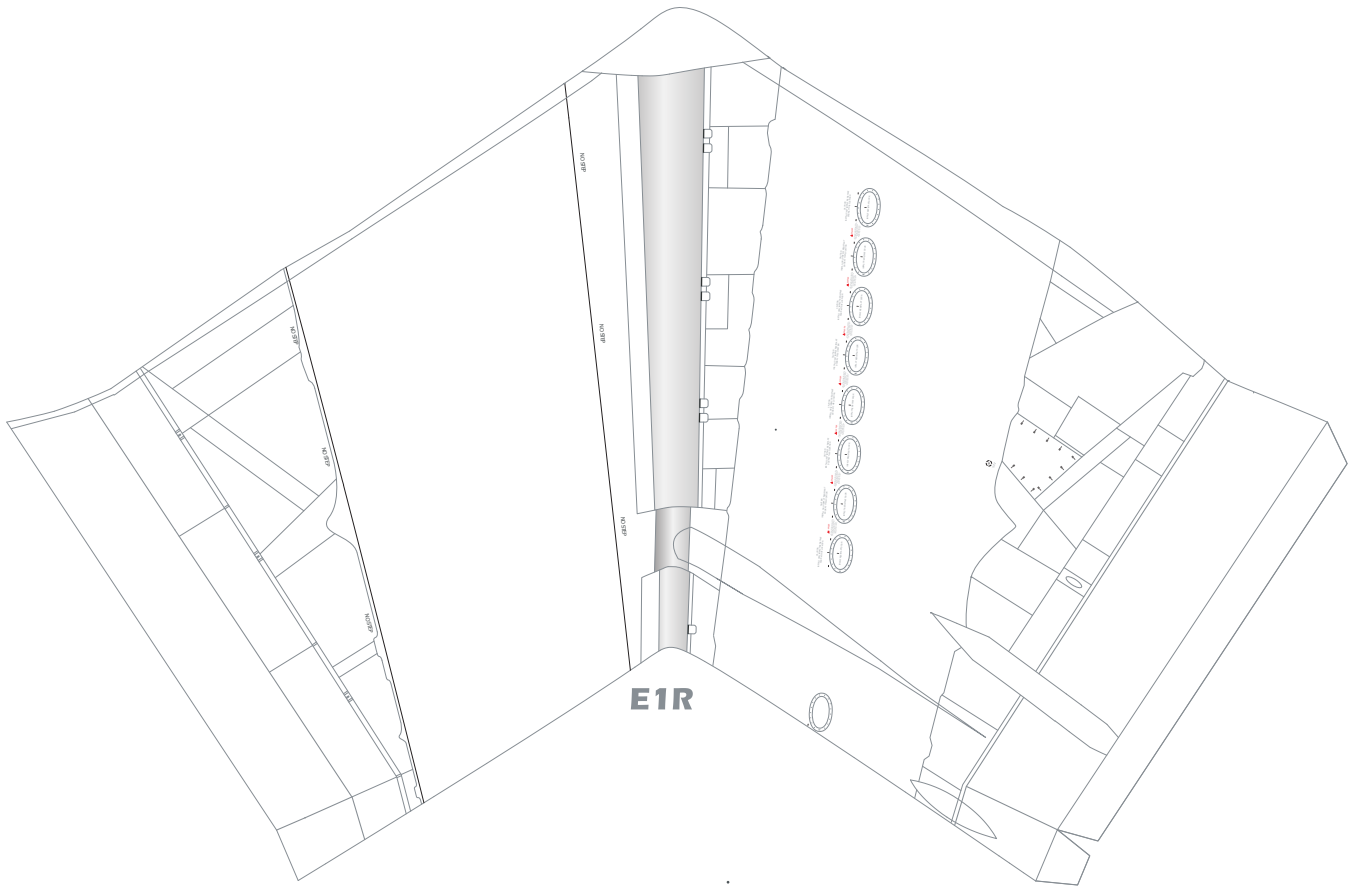
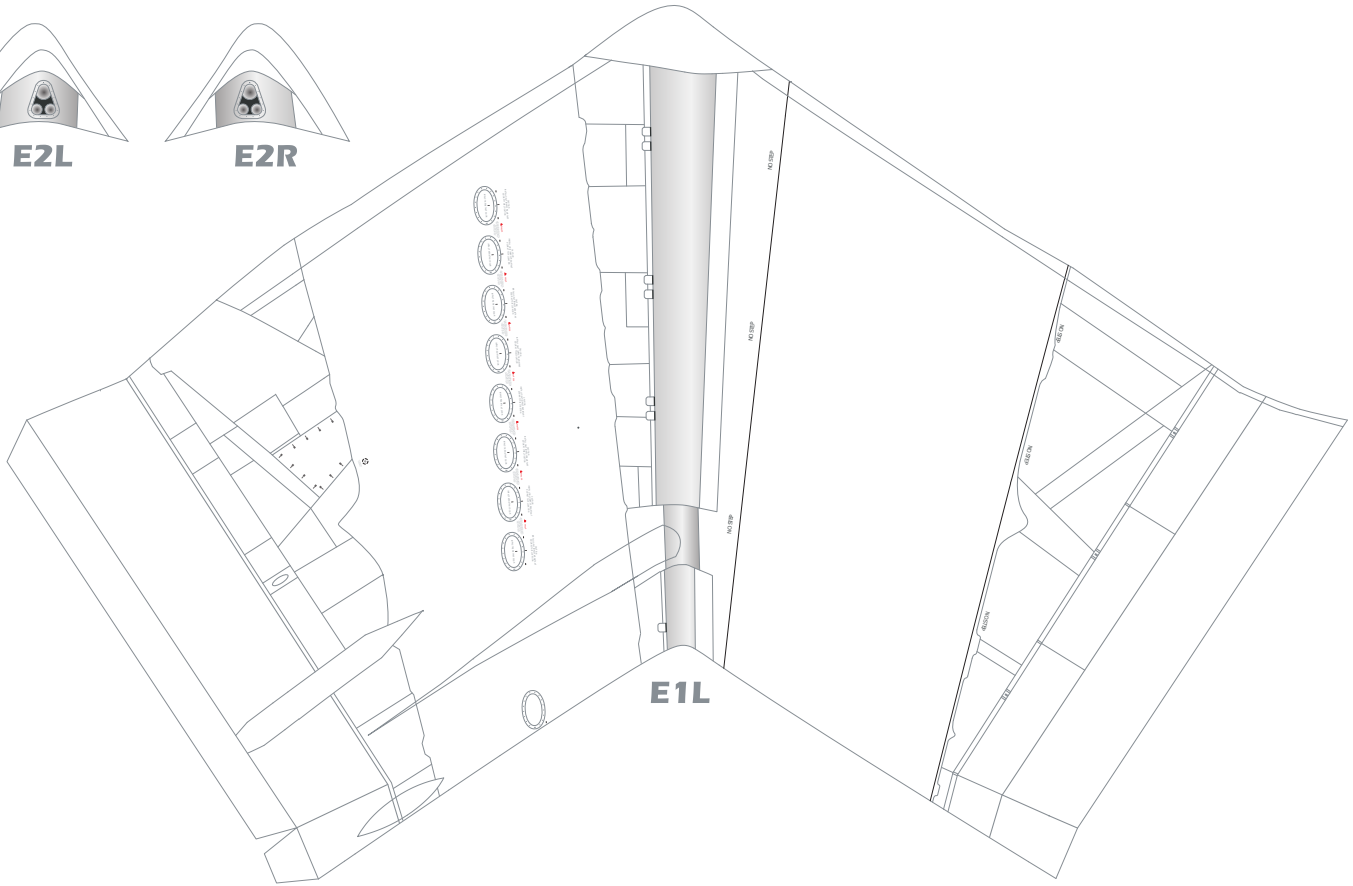

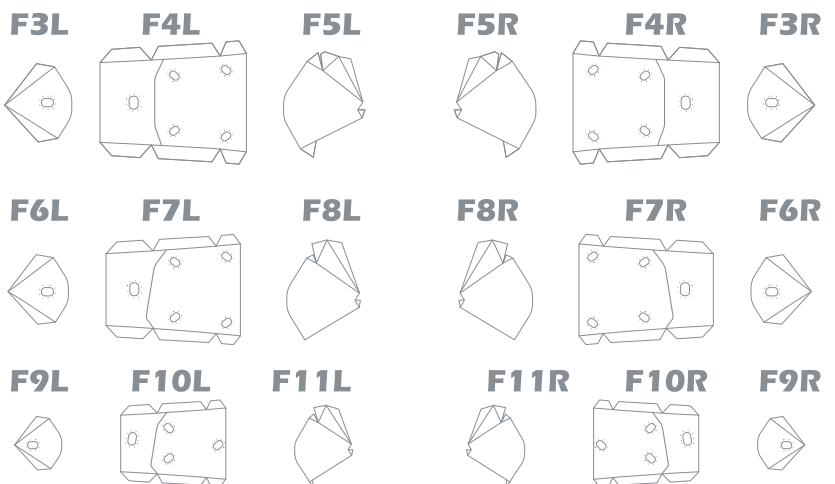
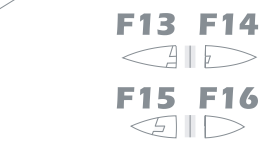
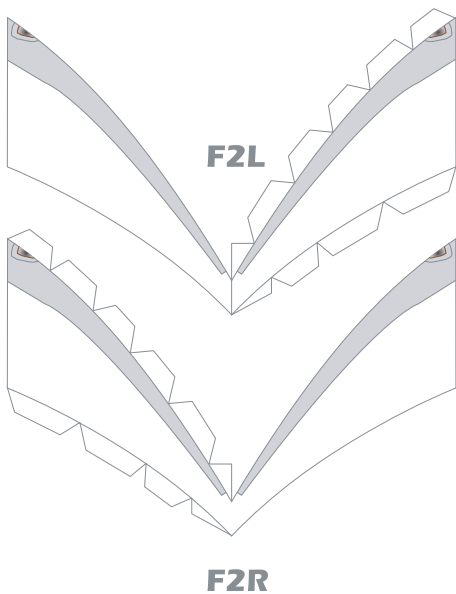
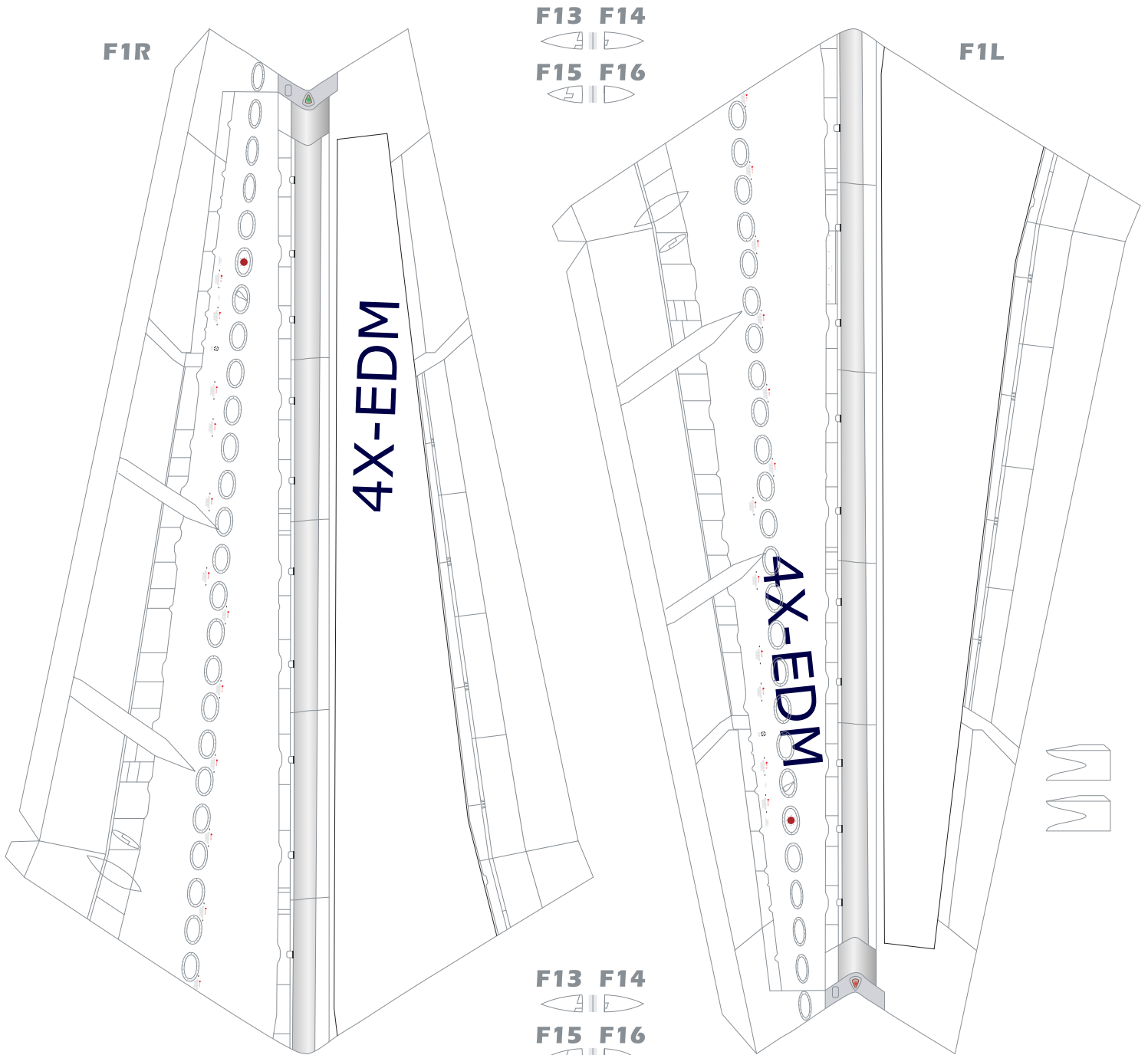

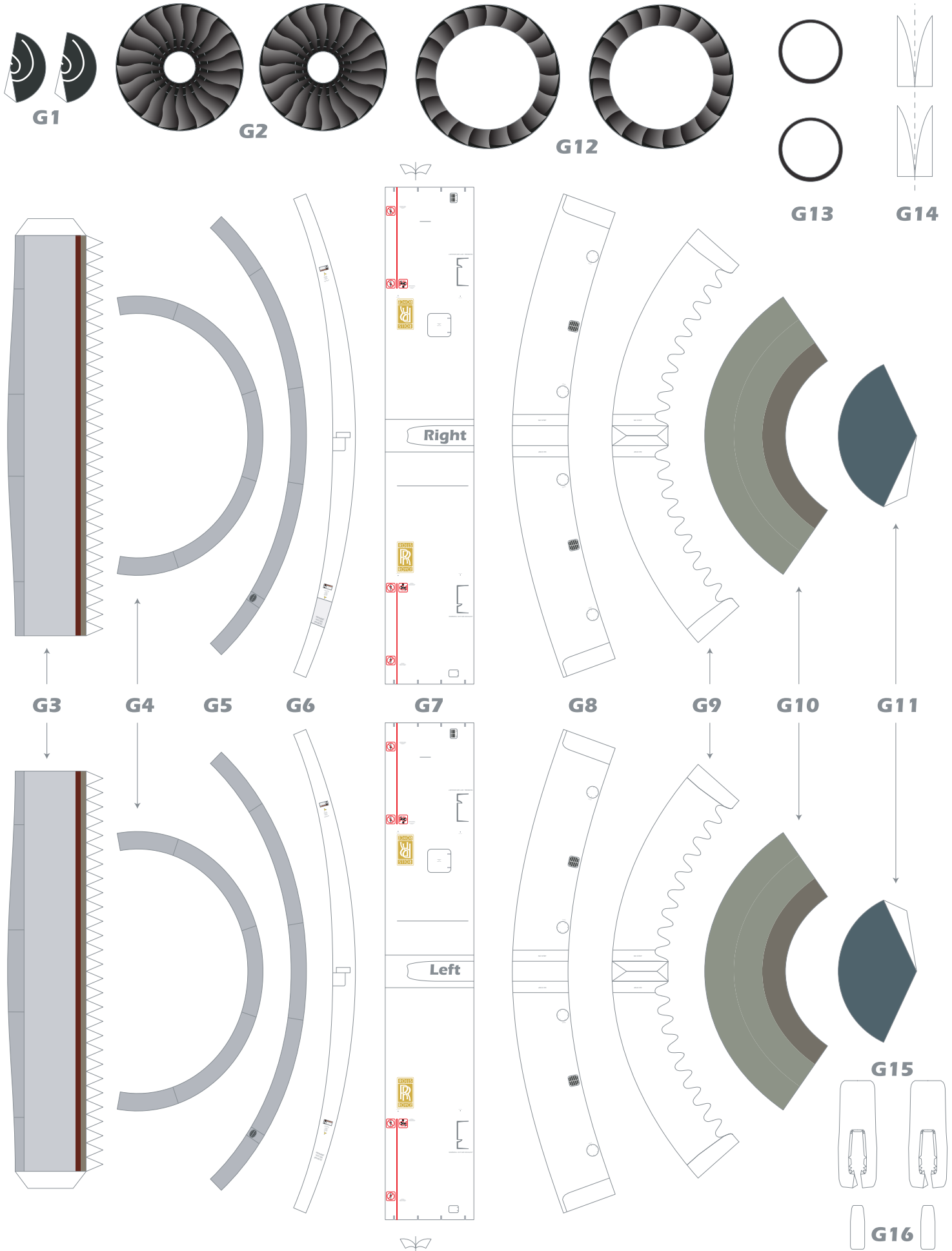

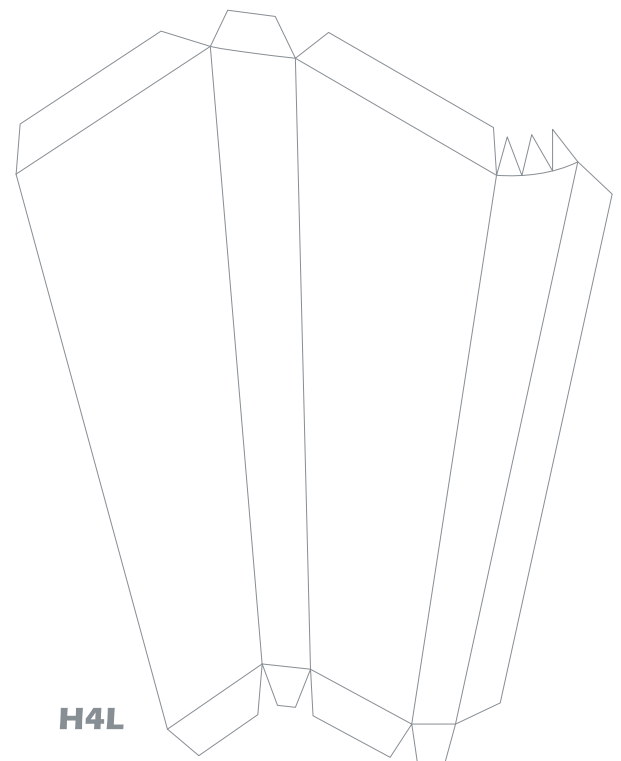
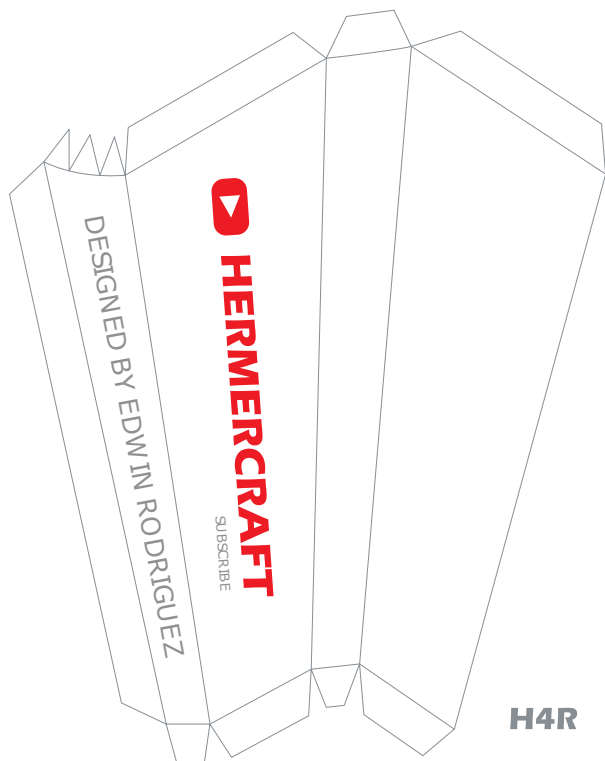
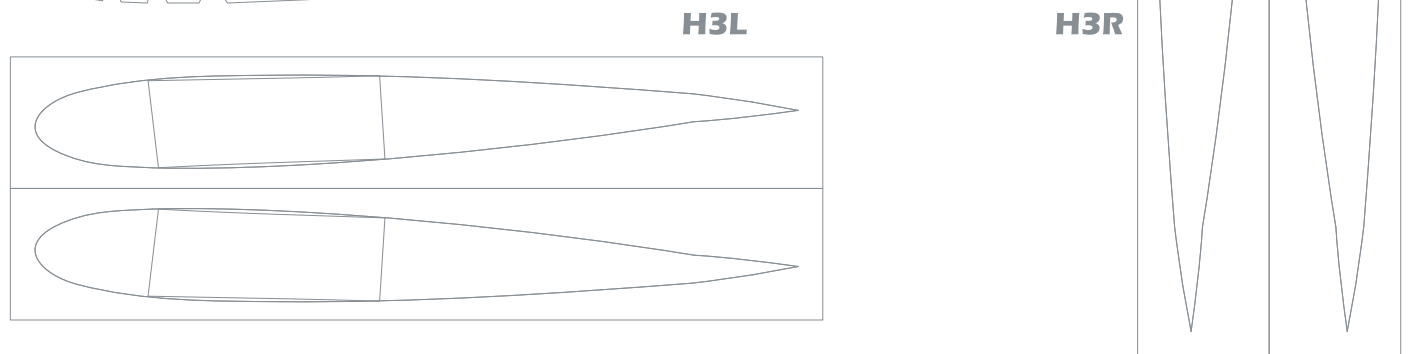
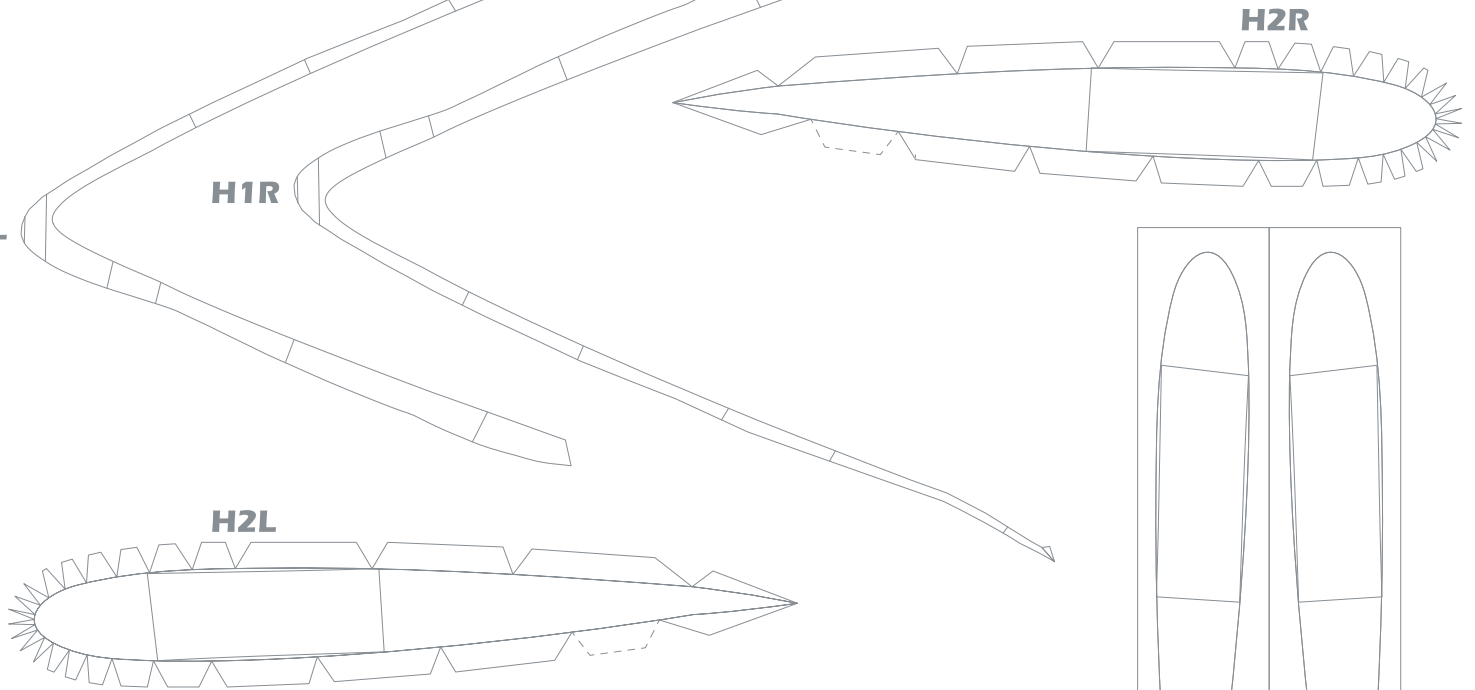
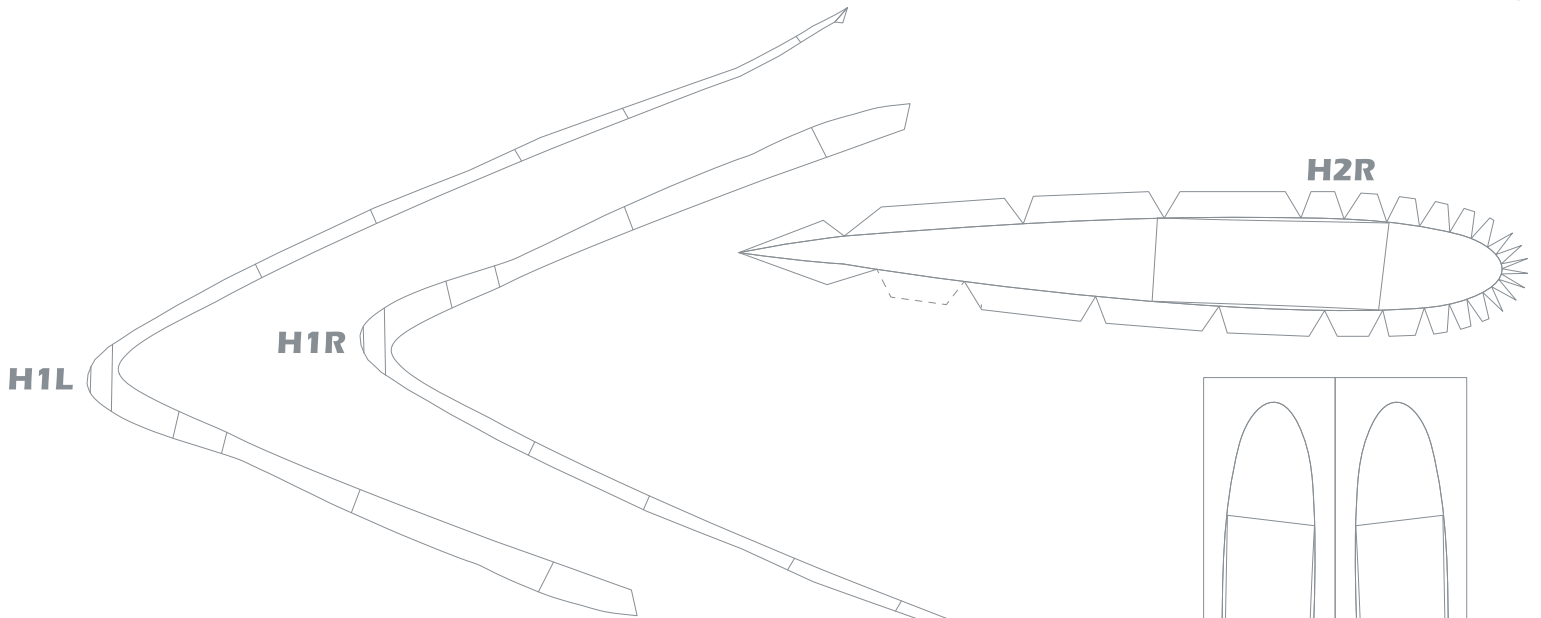

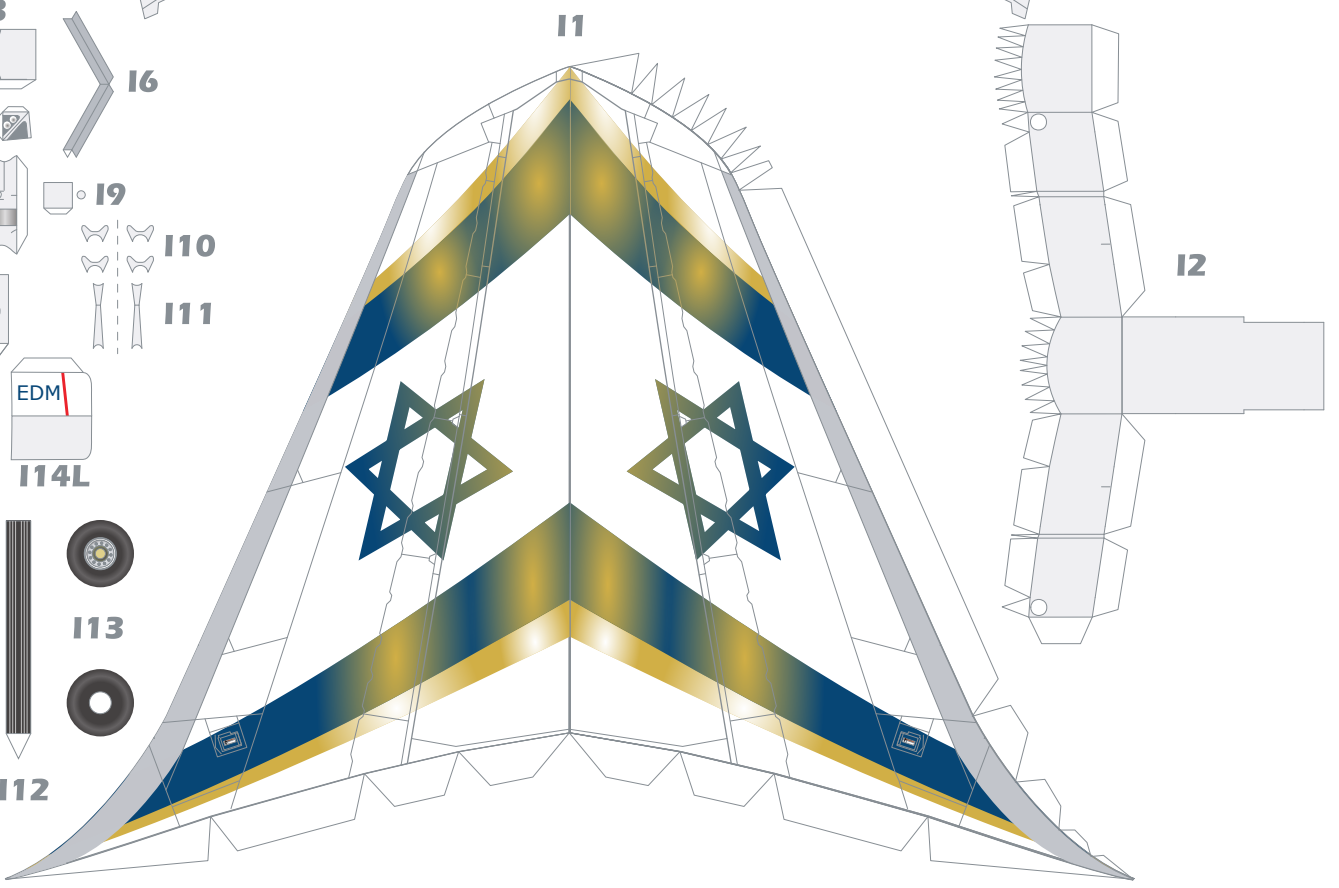
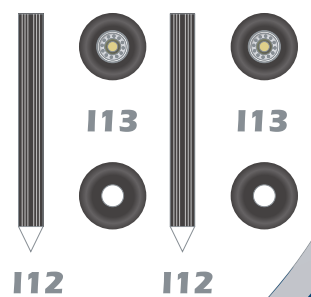
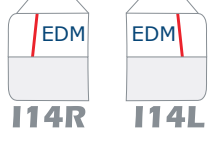
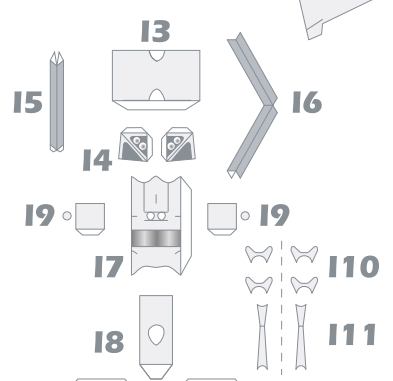
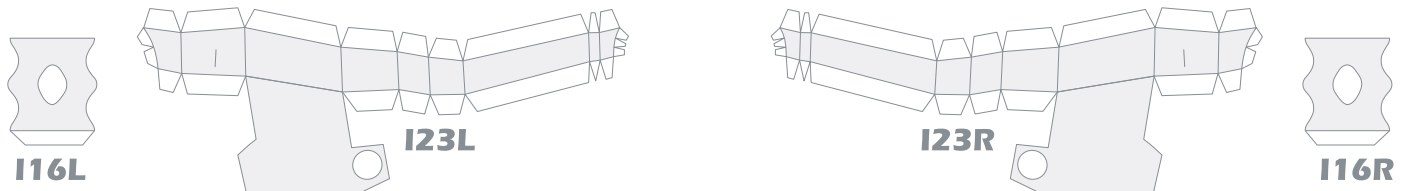
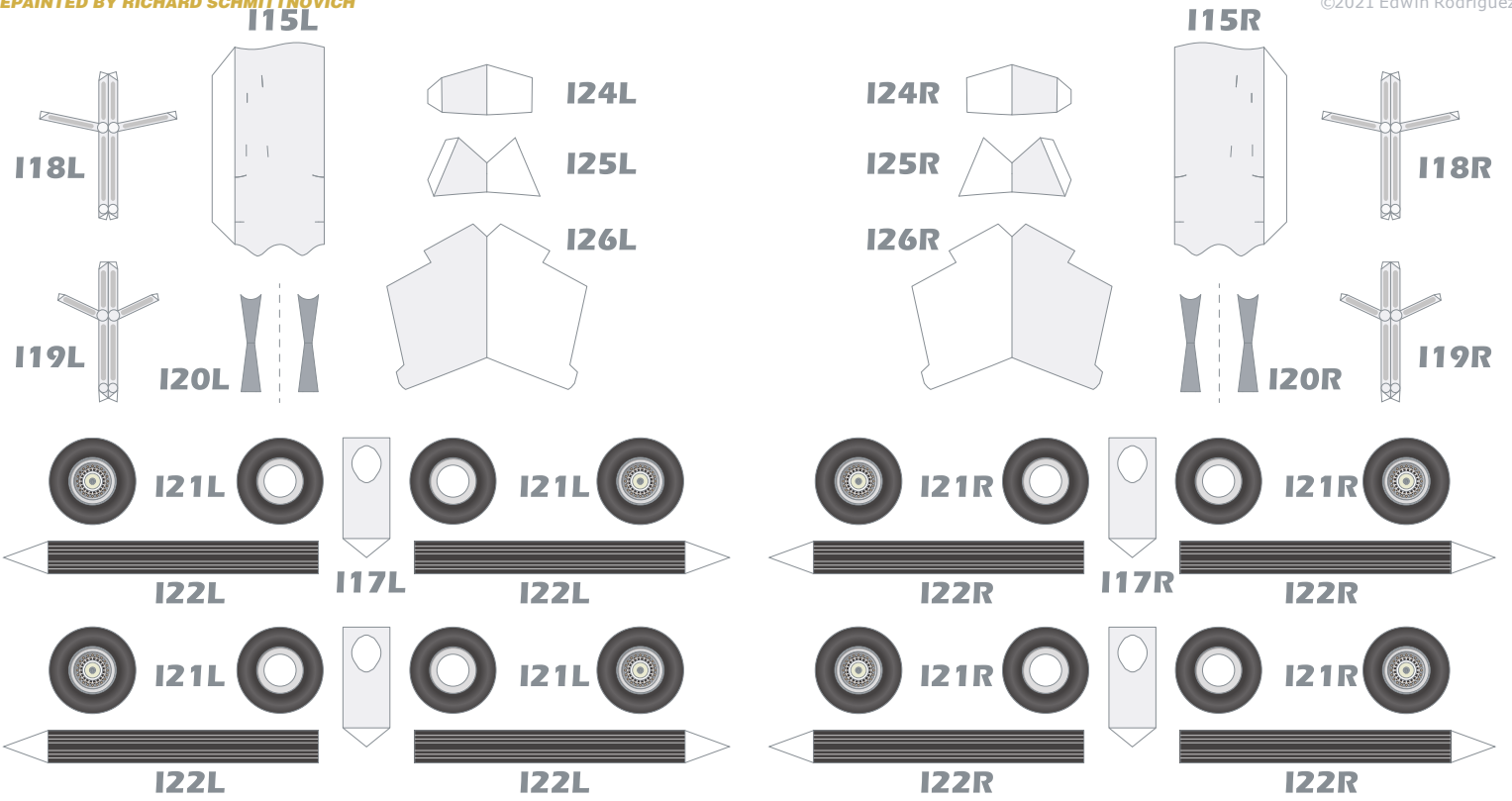

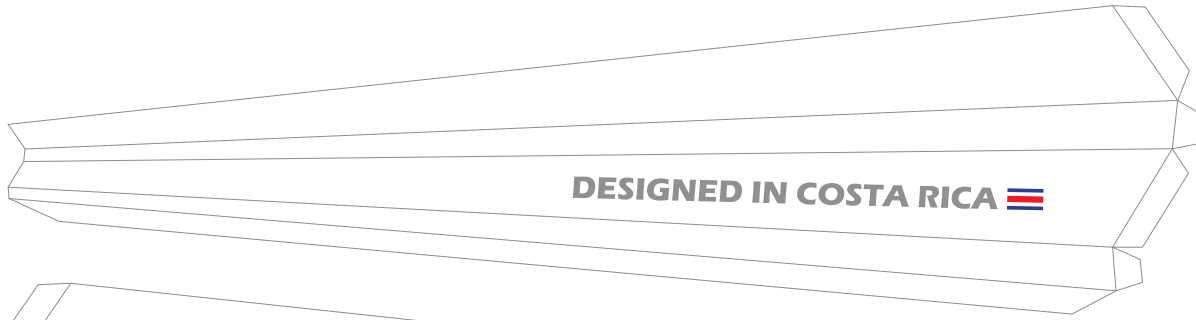

J1L



J1R

