

Blank space for 787-9 and 10 variants

Instructions



Scan

A14

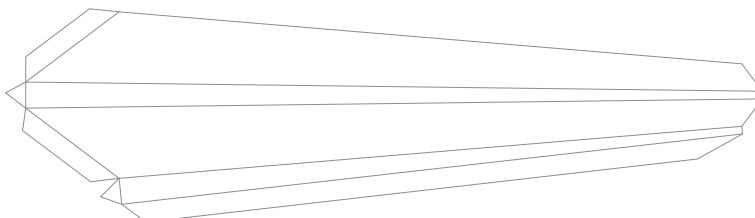

A16L

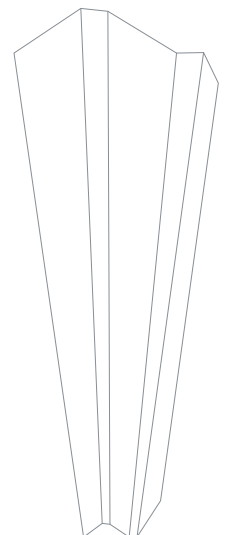

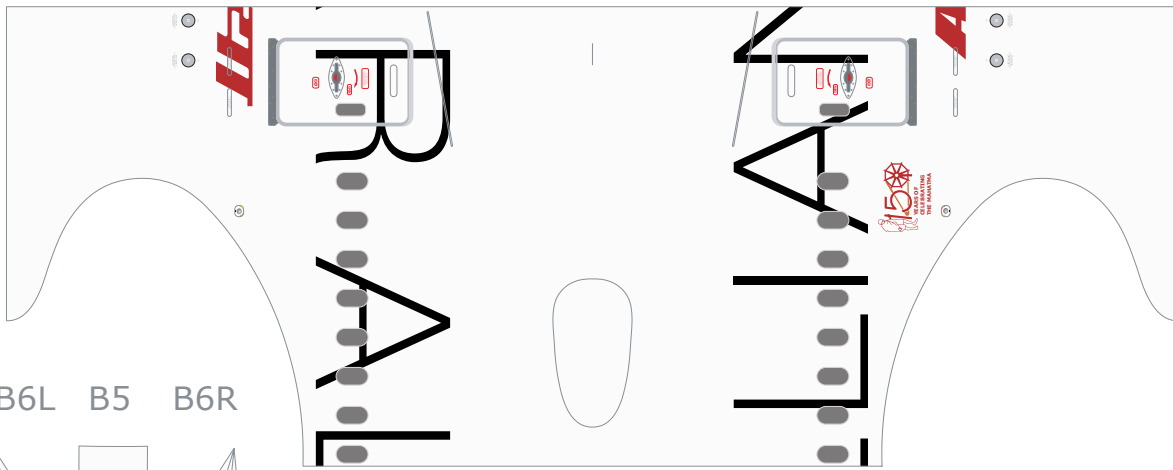

B1

B6L B5 B6R

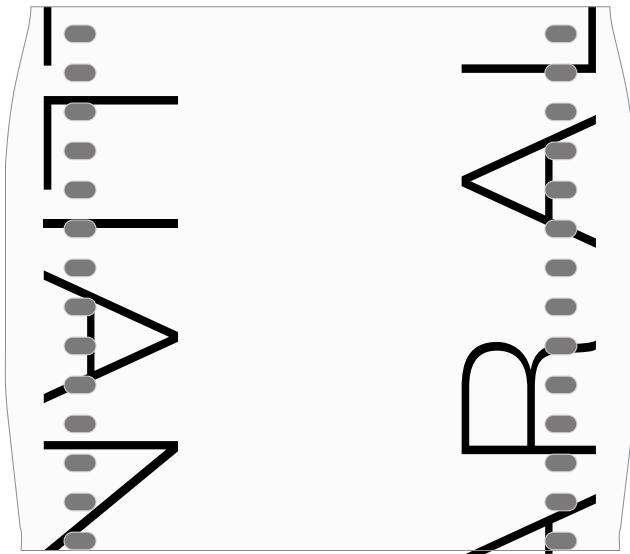
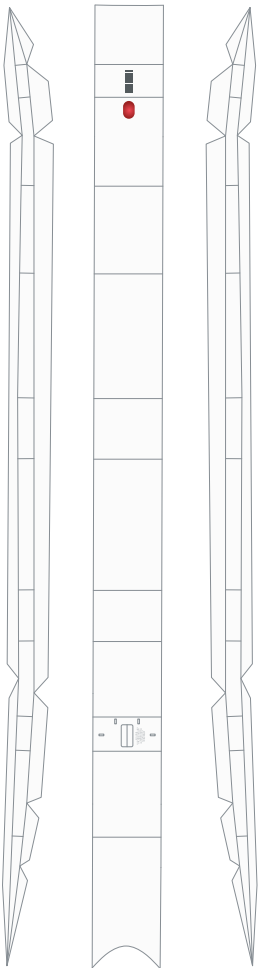

B2

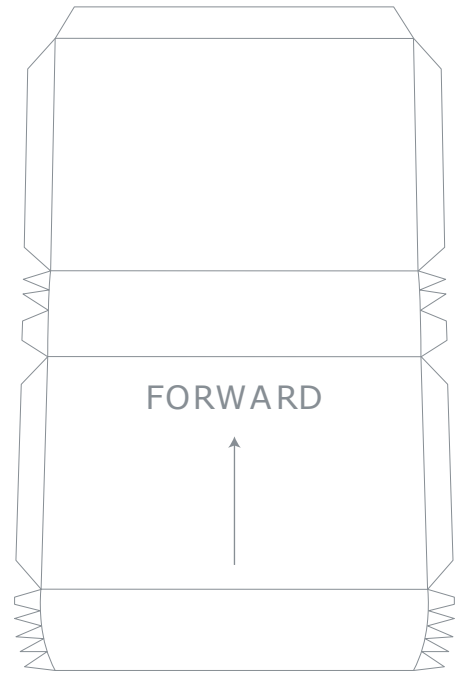

B4

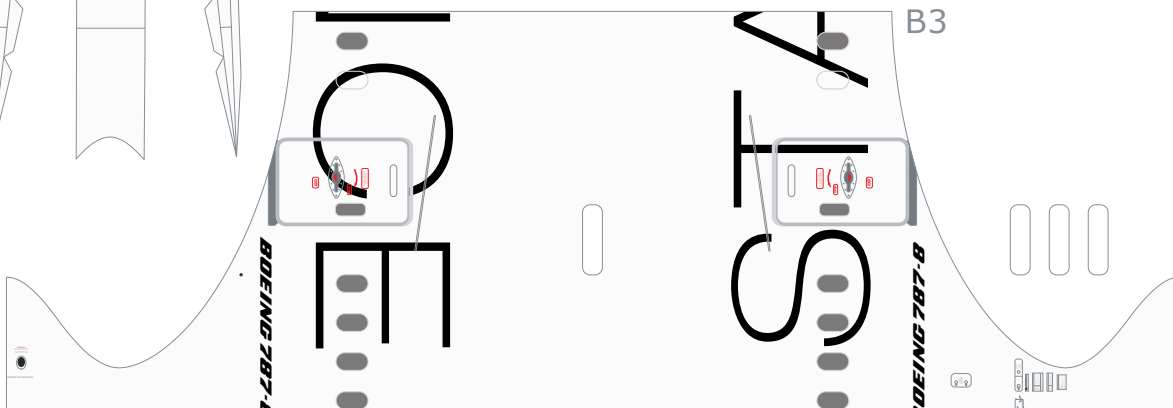

B3

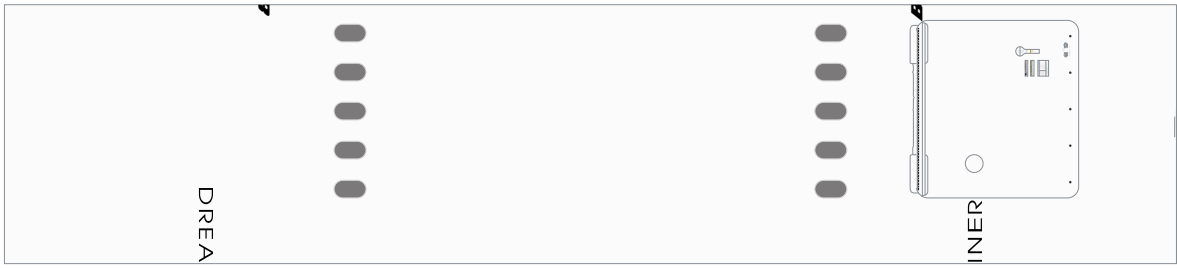

C1

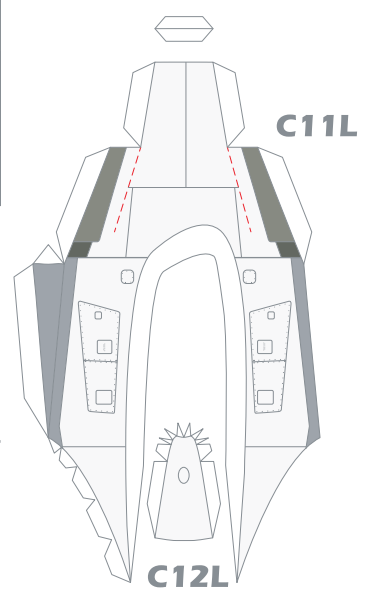

C11L

C12L

Blank space for 787-9 and 10 variants

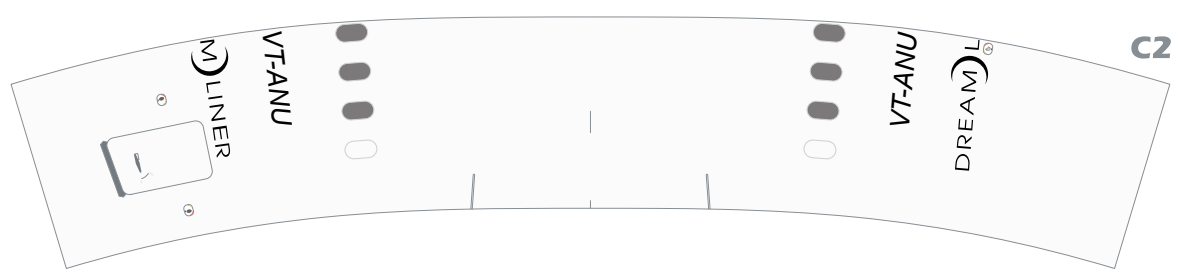

C2

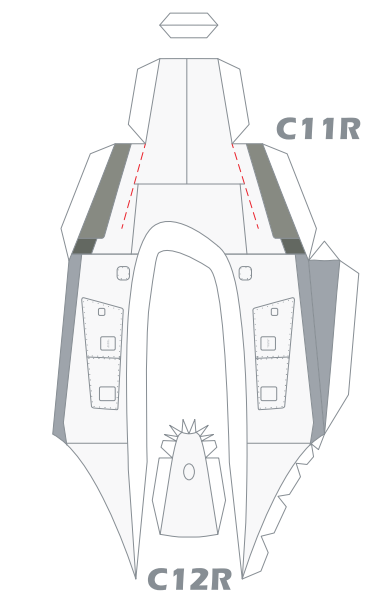

C11R

C12R

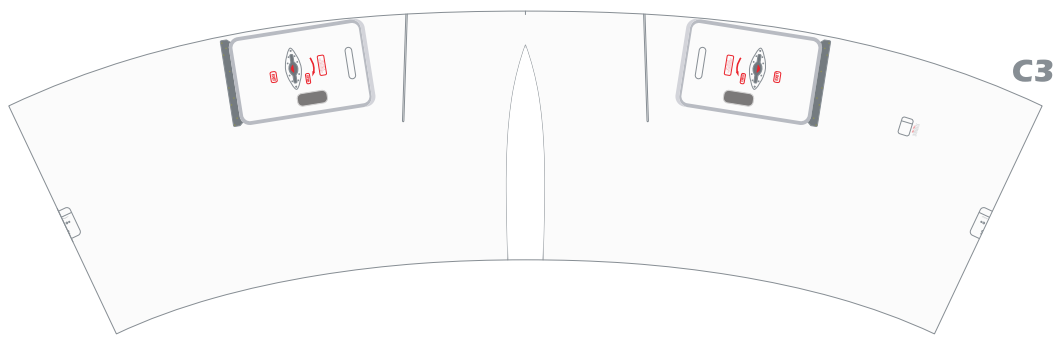

C3

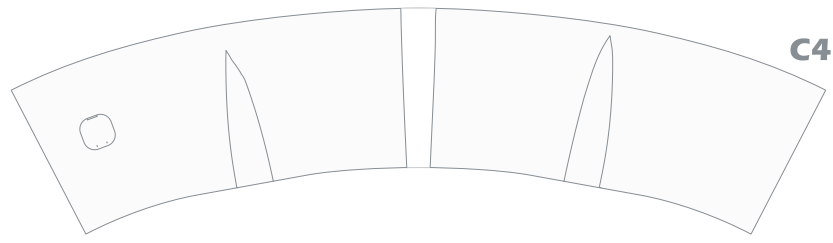

C4



C8

C9

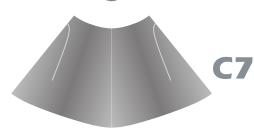

C7

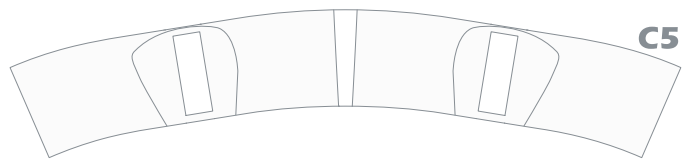

C5

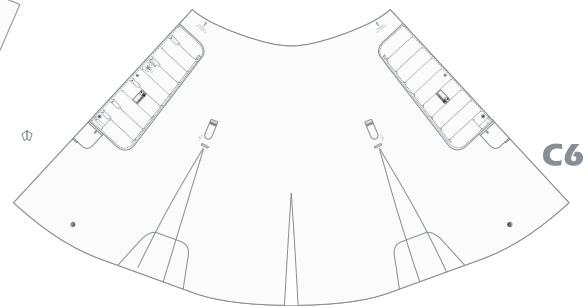

C6



C10L



C10R

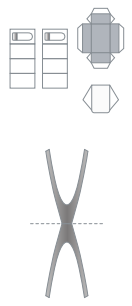

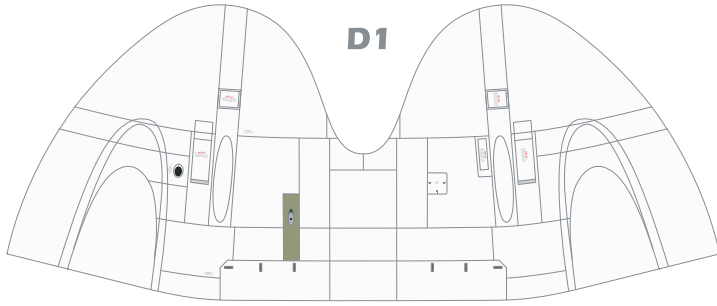

D1

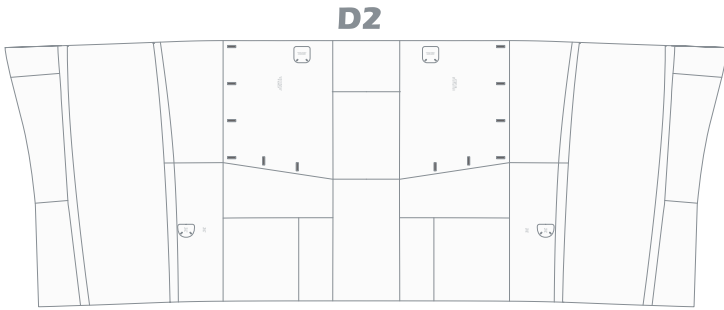

D2

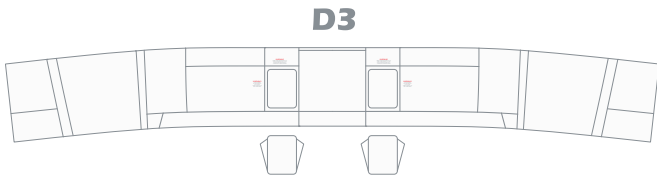

D3

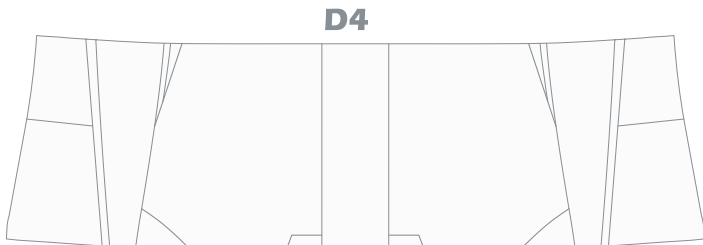

D4

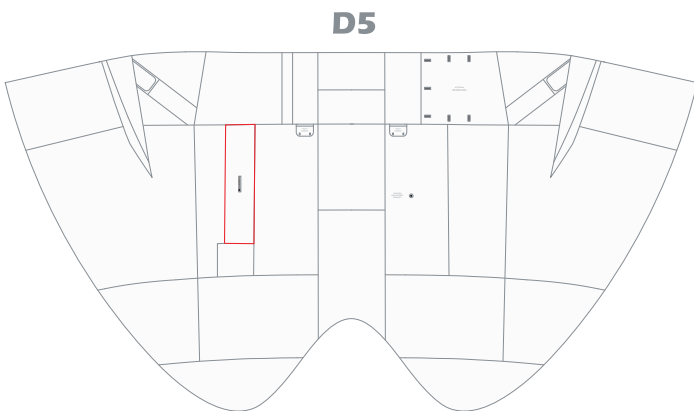

D5

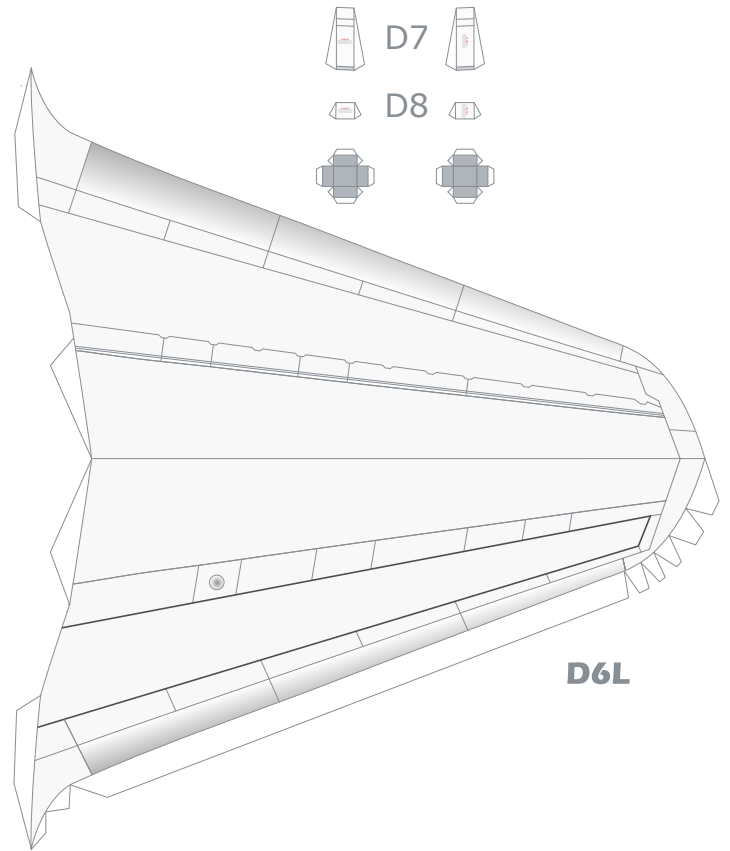

D6L

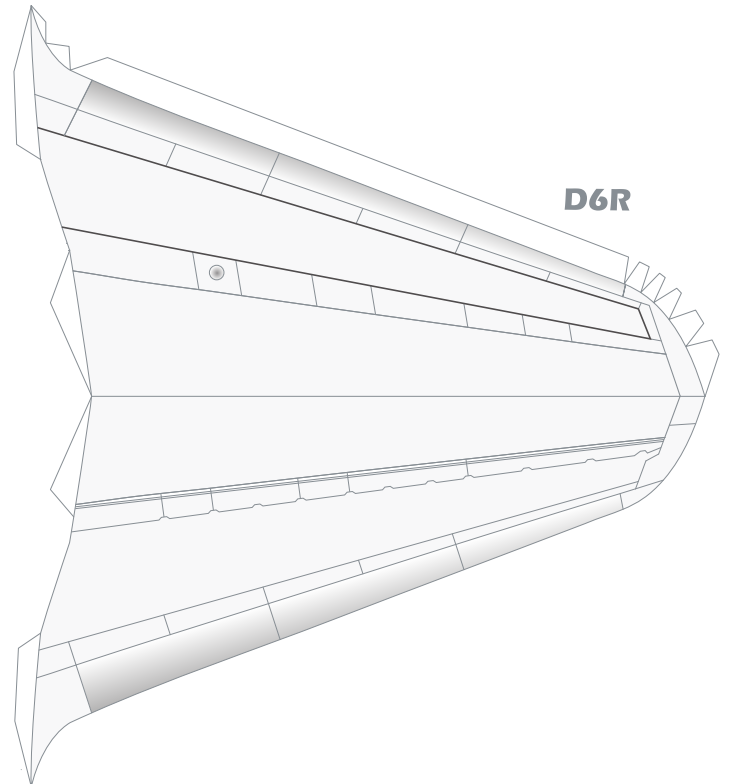
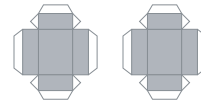

D6R



E2L



E2R

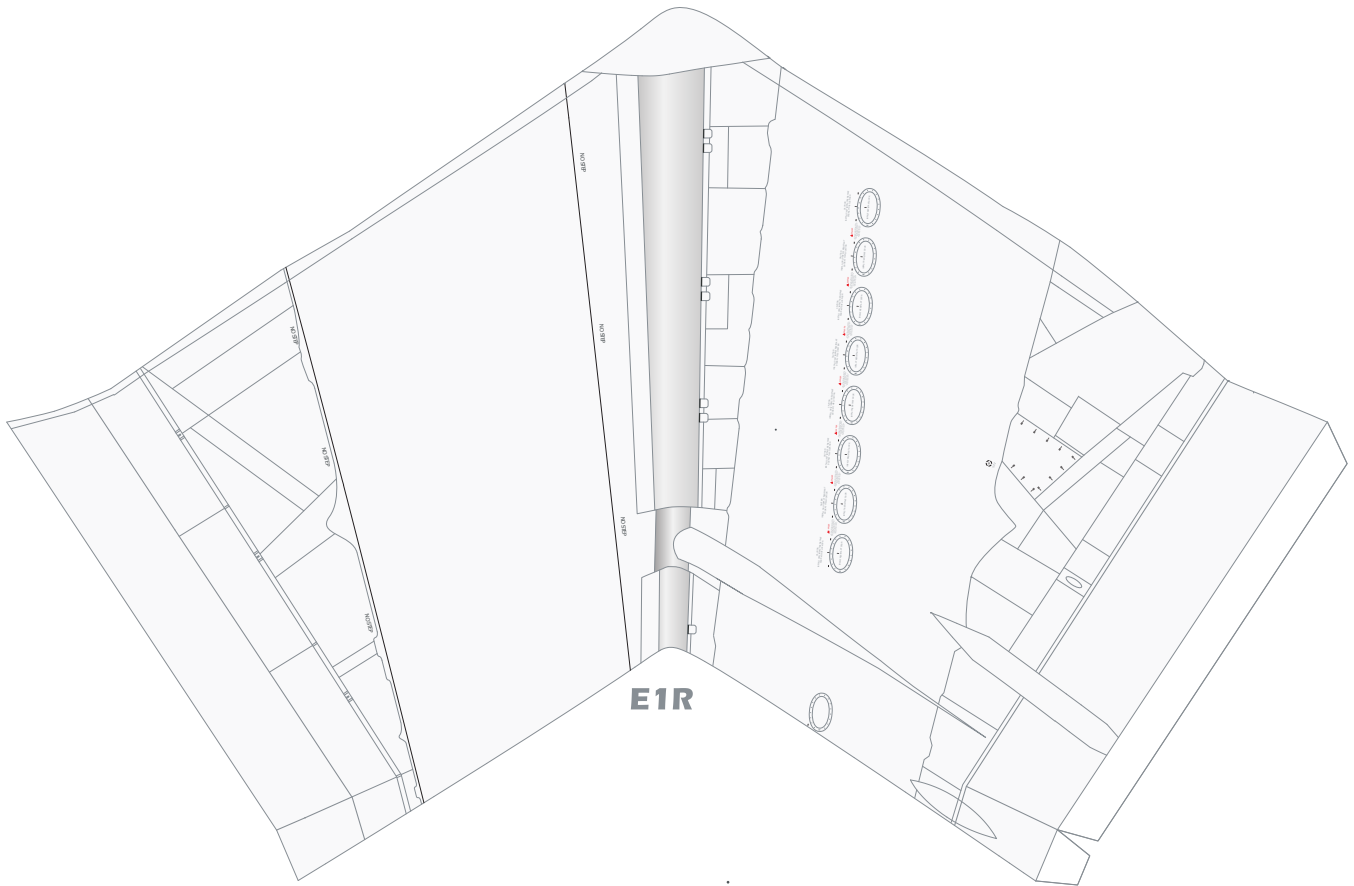
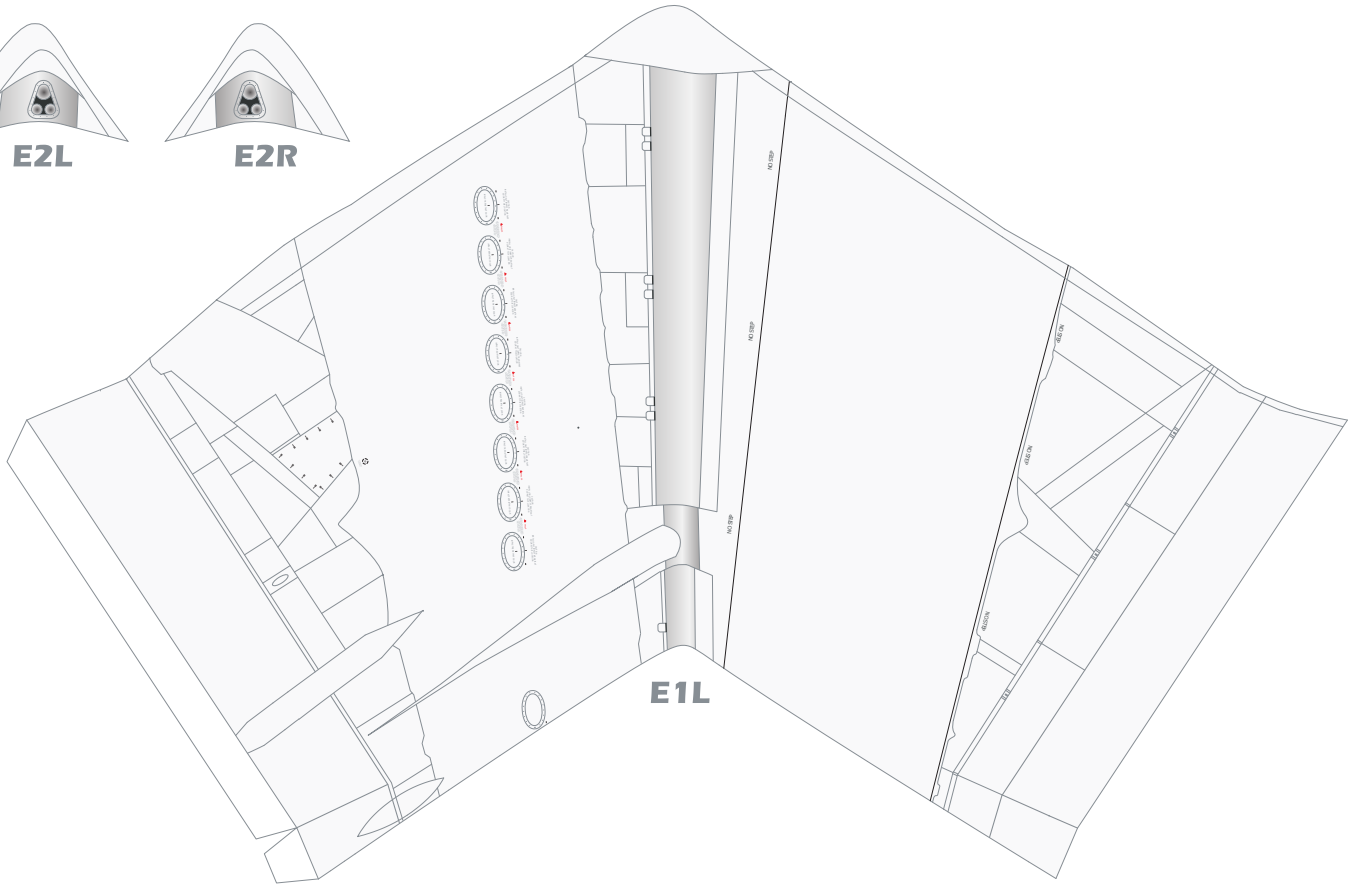

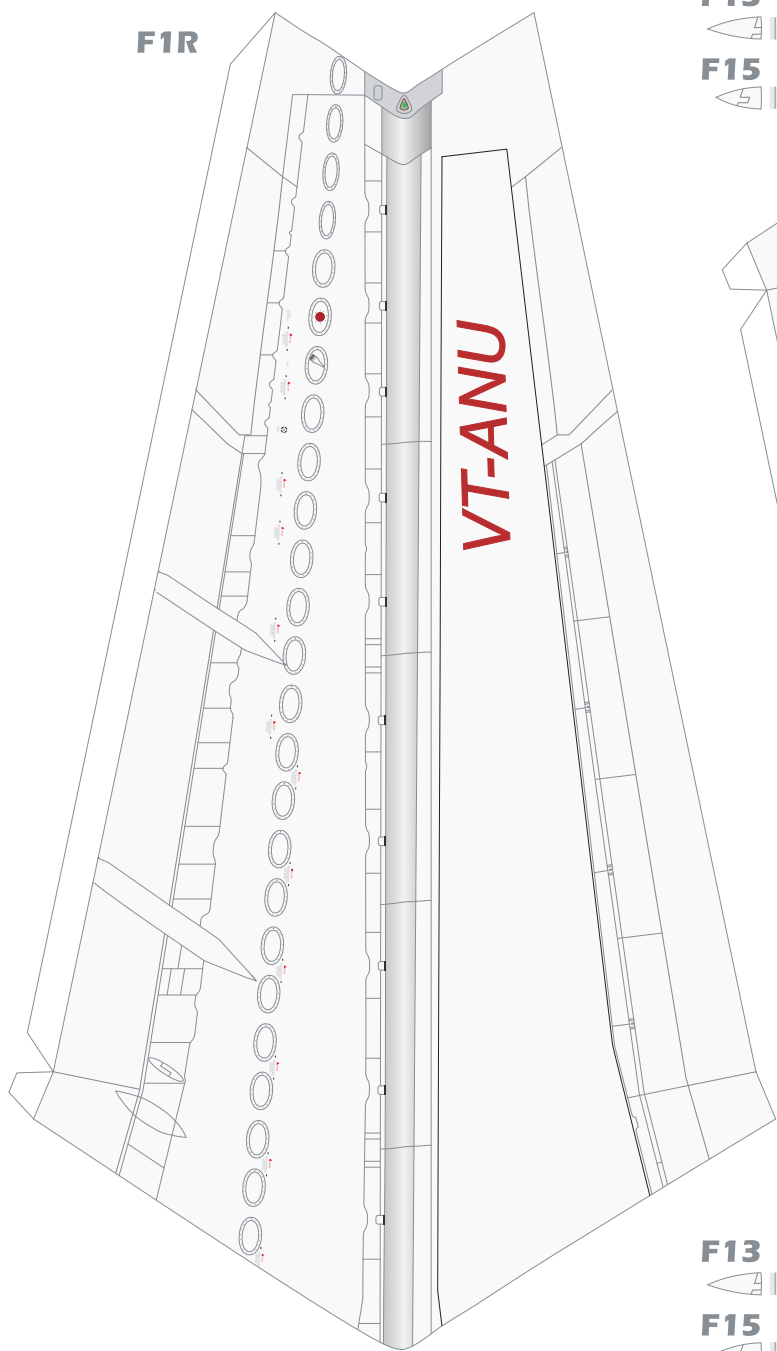

F13 F14



F15 F16

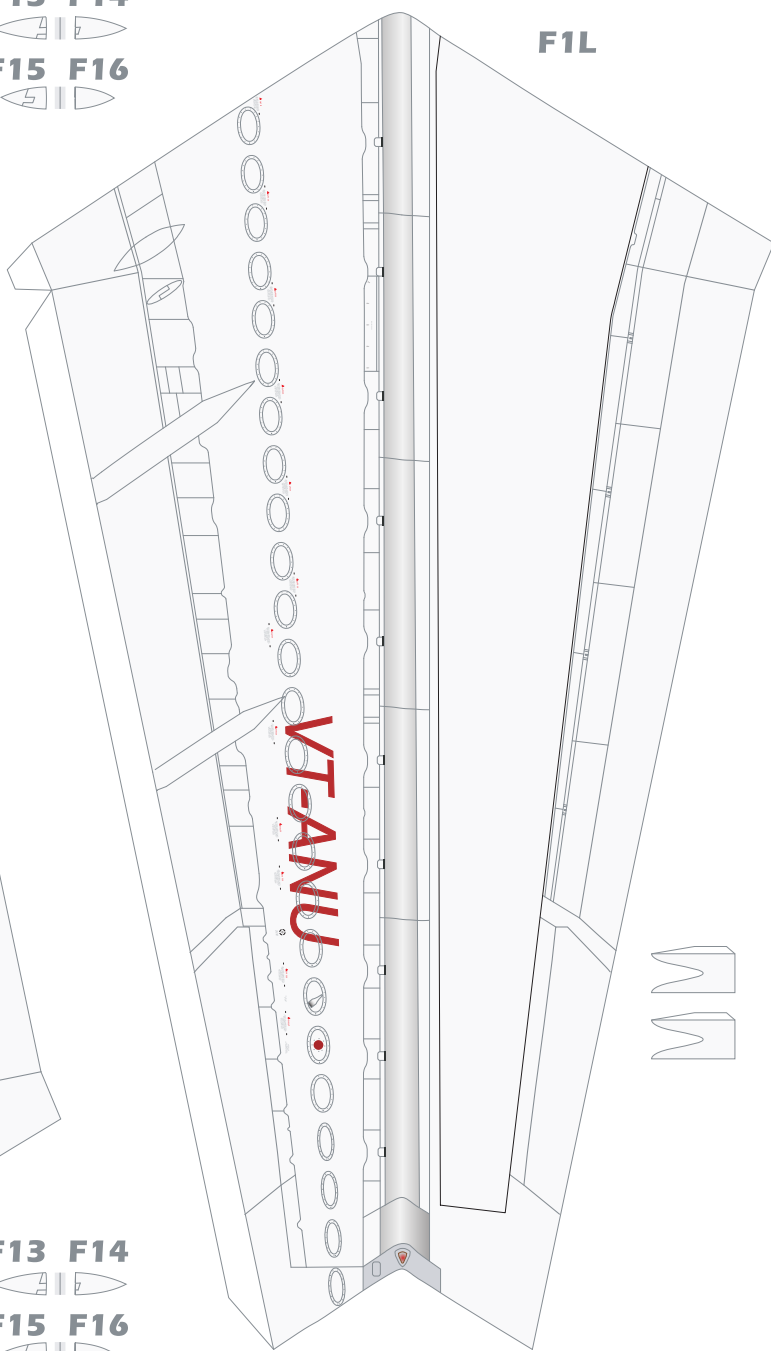

F13 F14



F15 F16

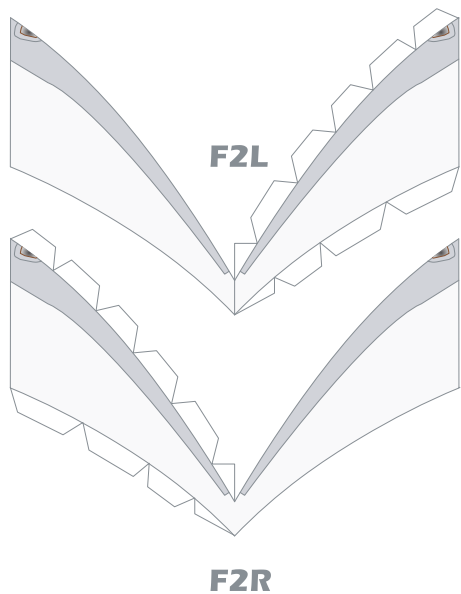

F3L



F4L

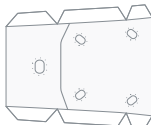

F5L



F5R



F4R

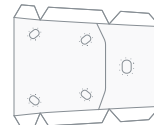

F3R



F6L



F7L

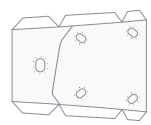

F8L



F8R



F7R

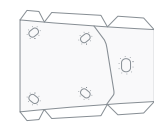

F6R



F9L



F10L

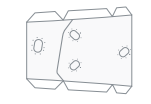

F11L



F11R



F10R

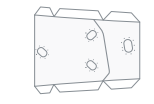

F9R



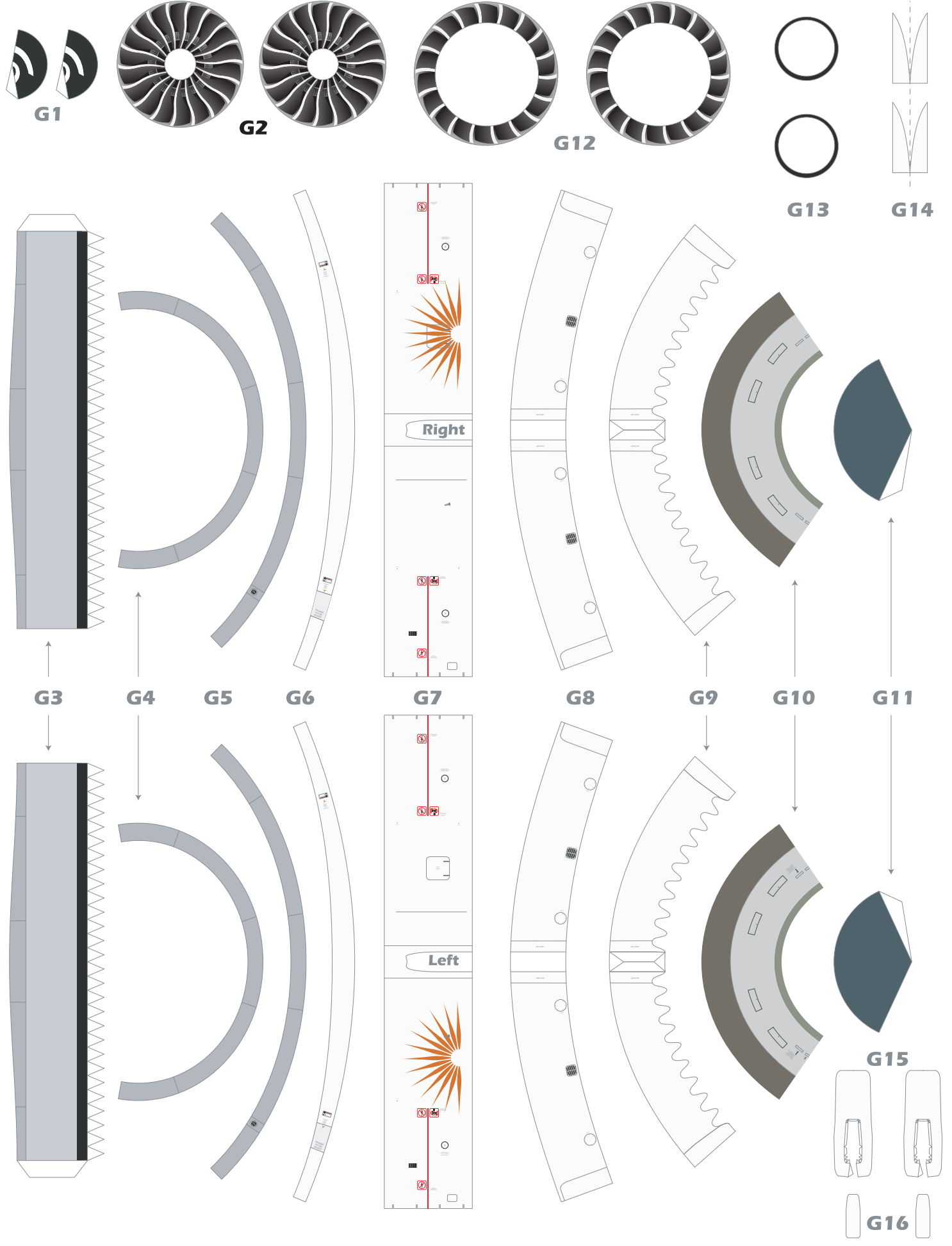

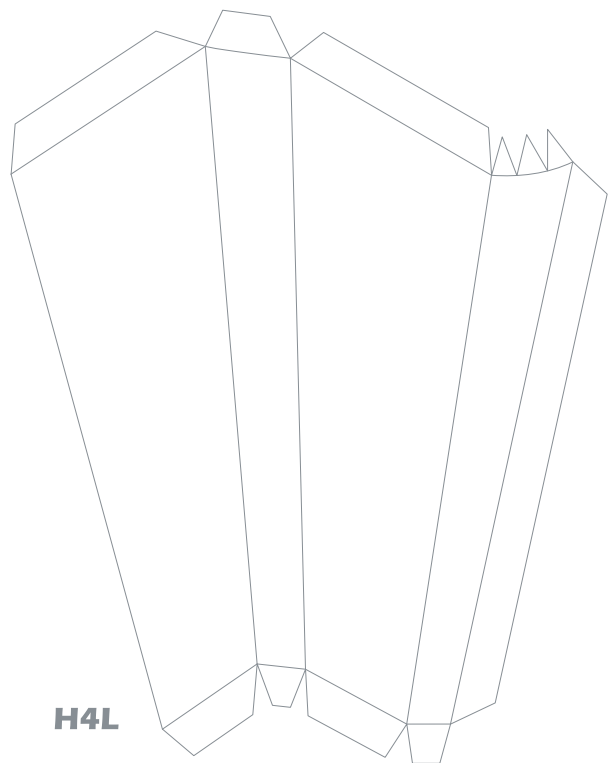
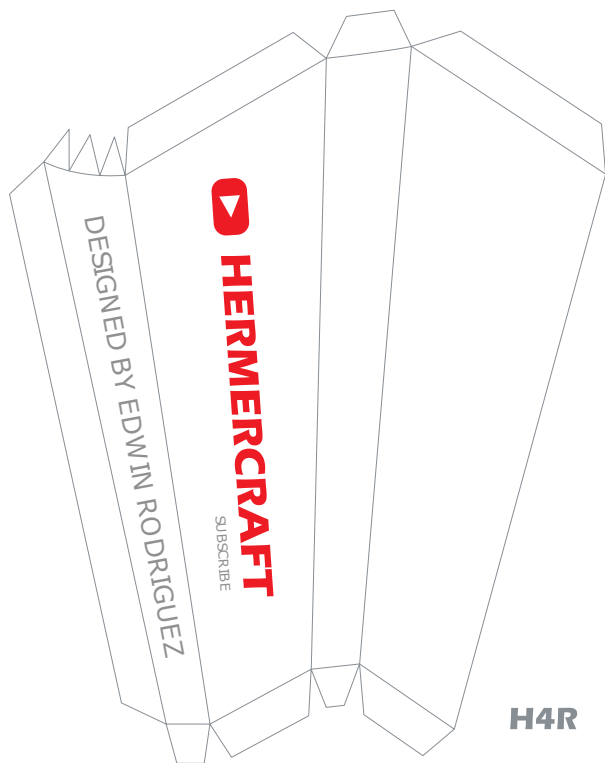
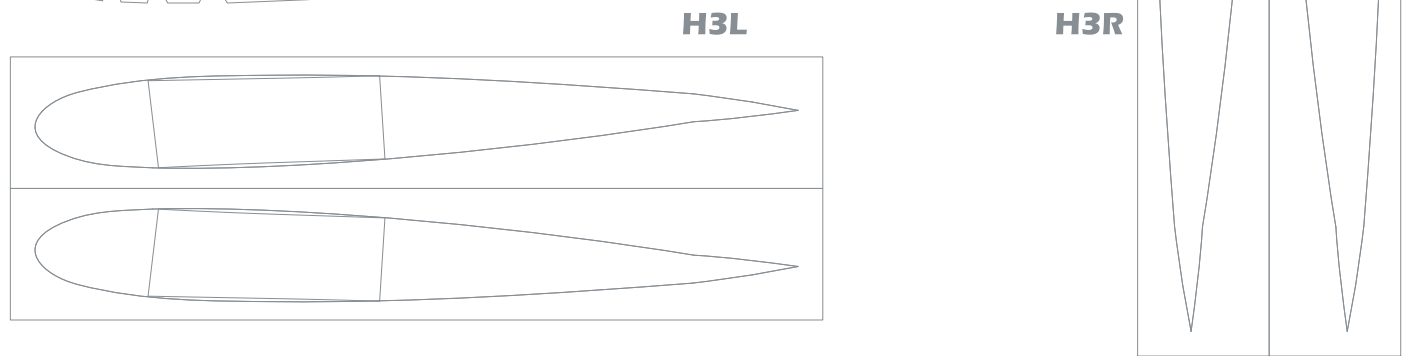
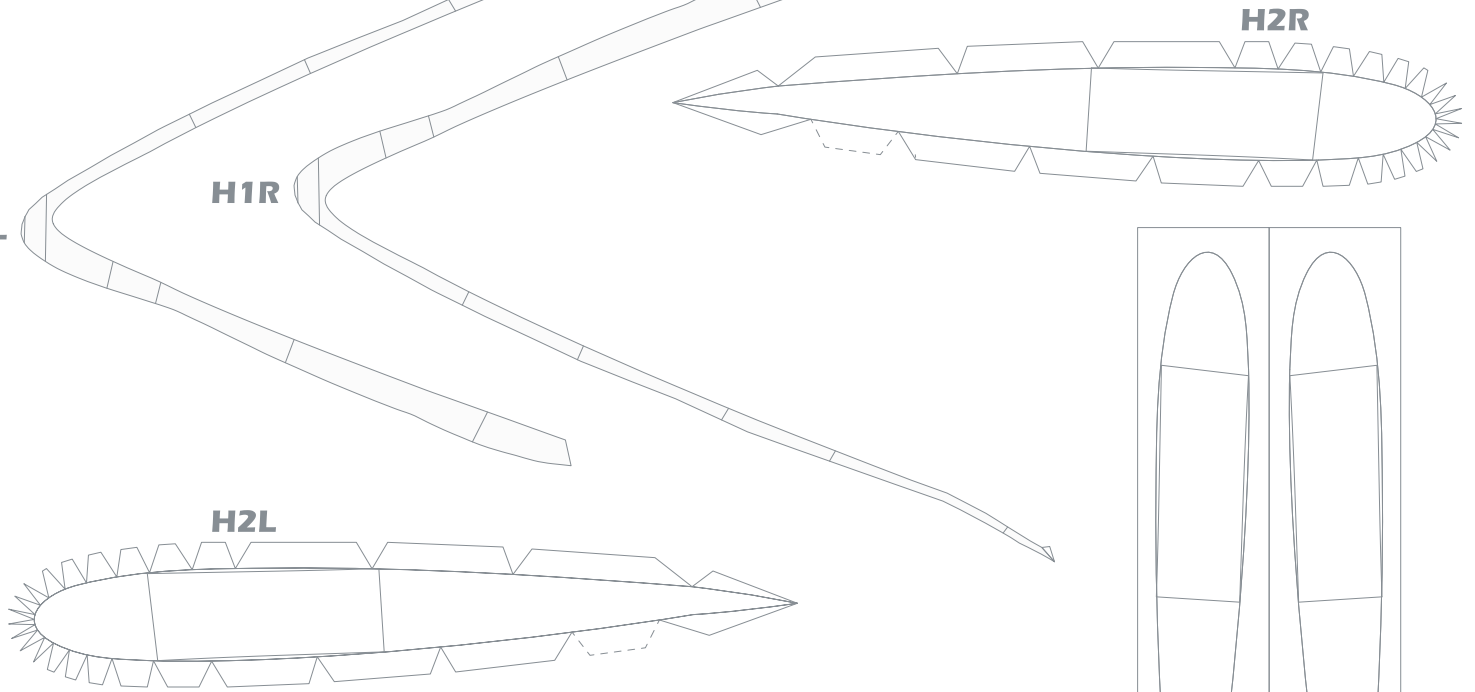
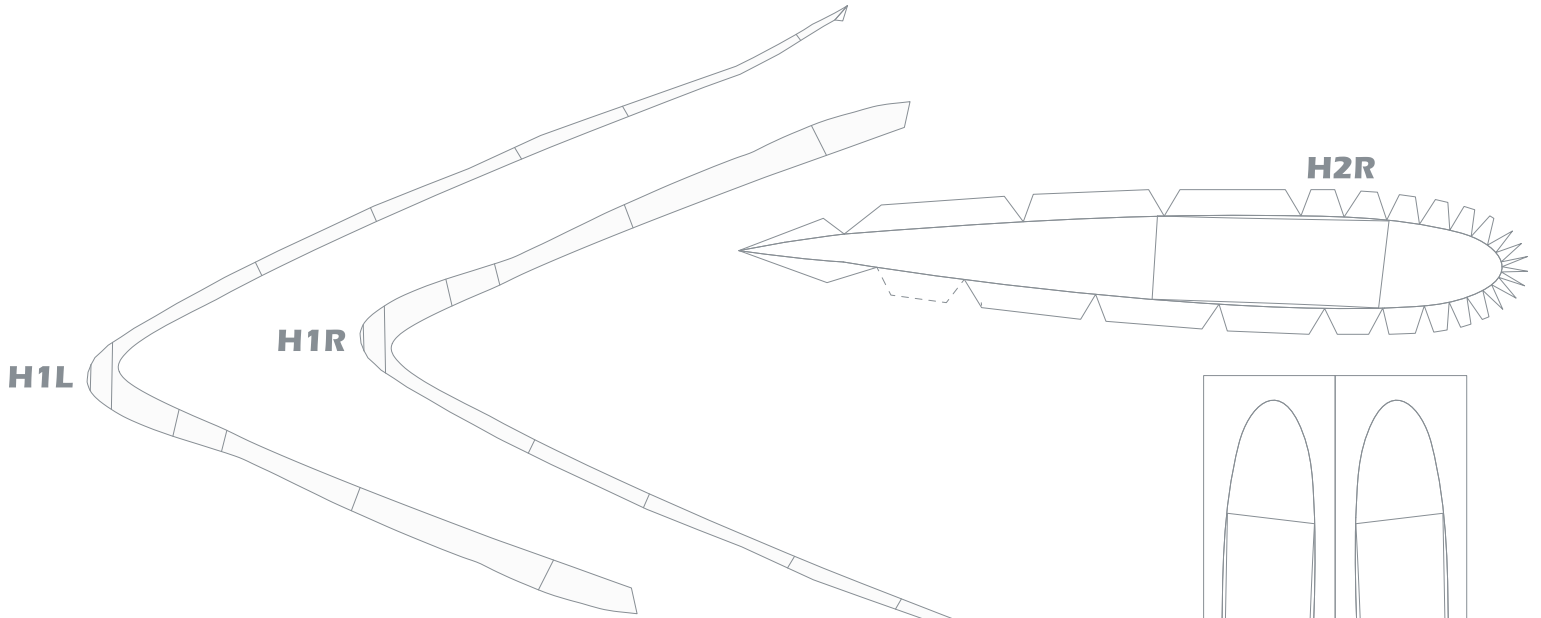



REPAINTED BY: RICHARD SCHMITTNOVICH

©2021 Edwin Rodríguez

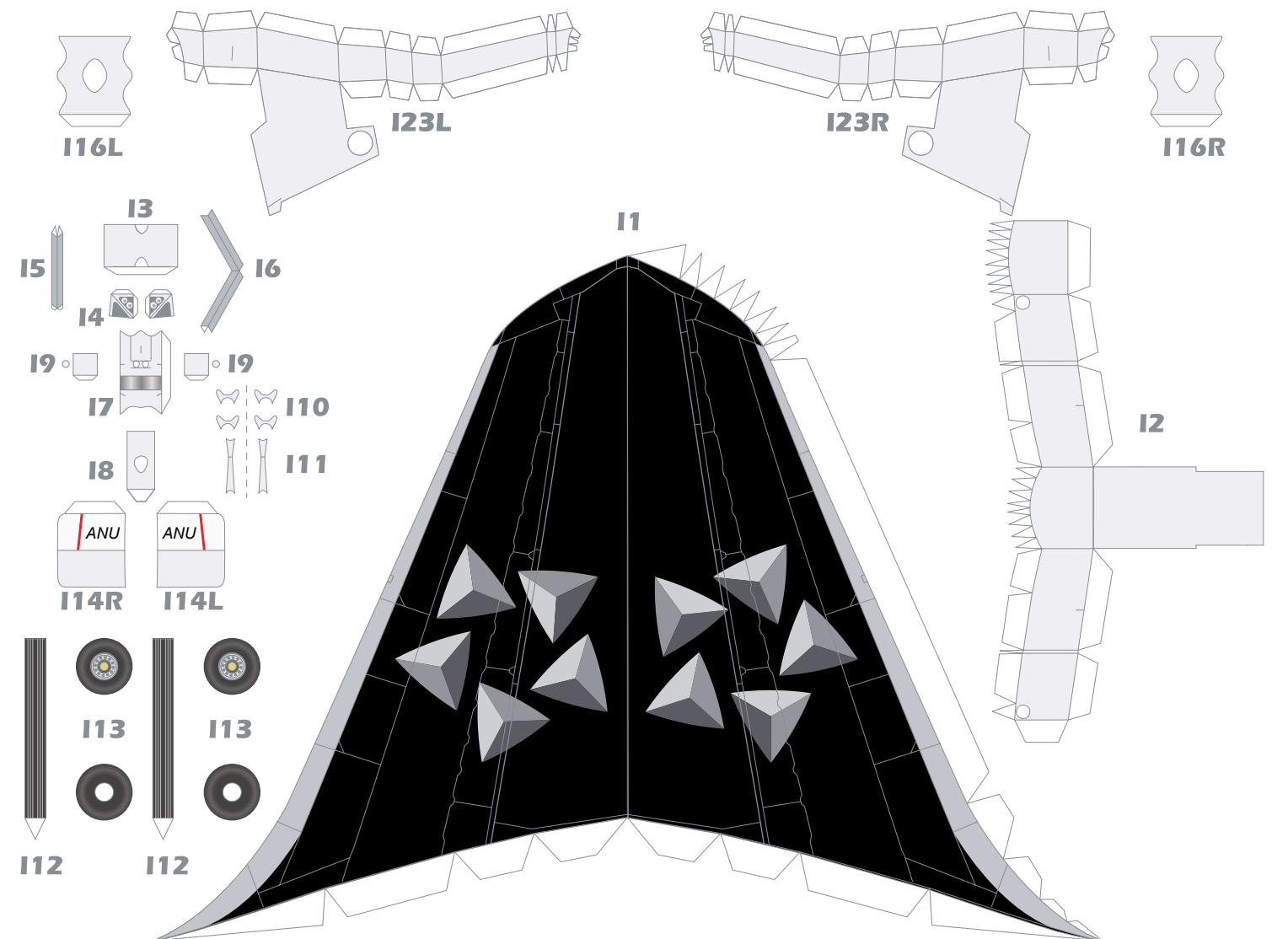
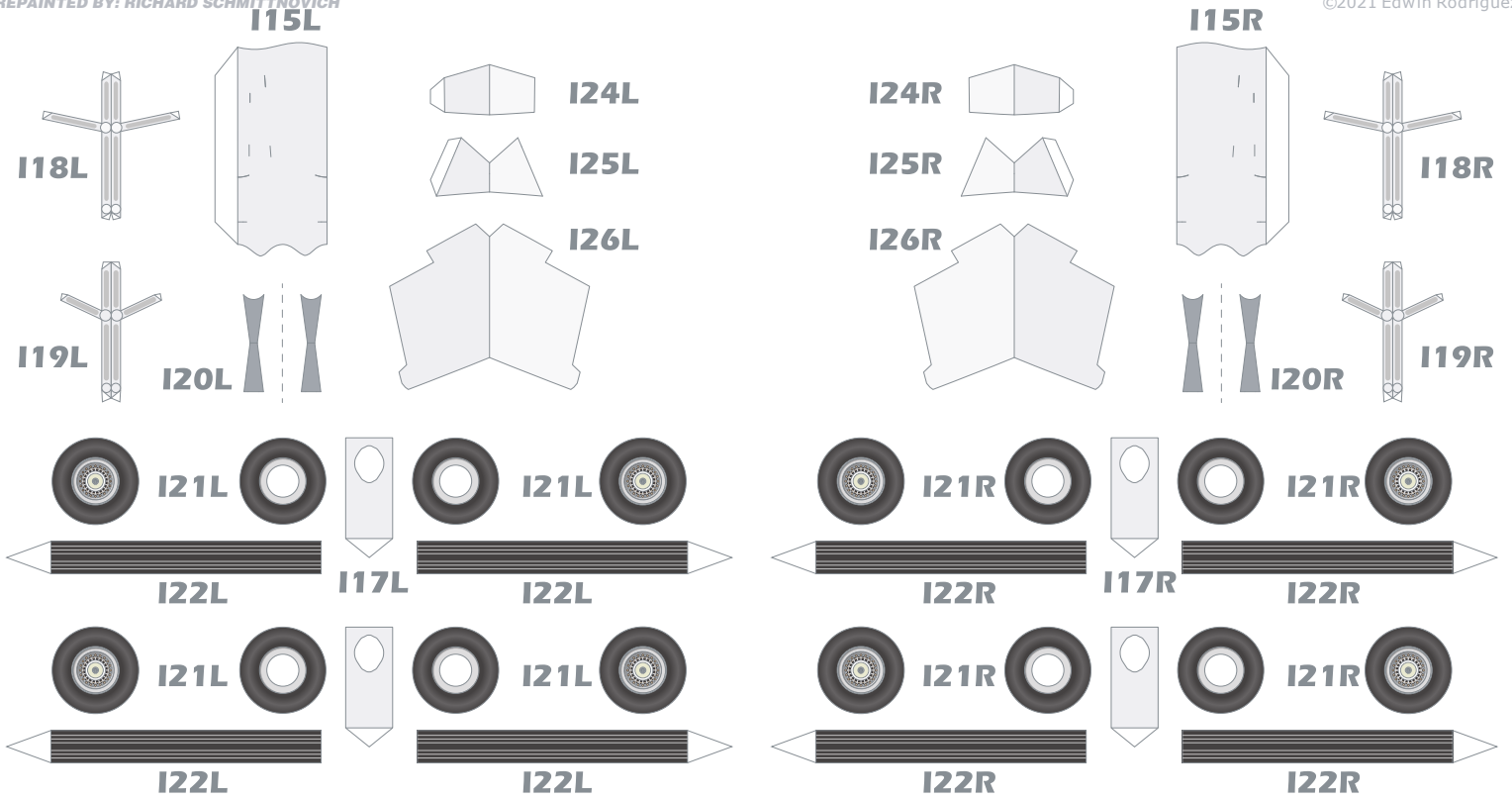

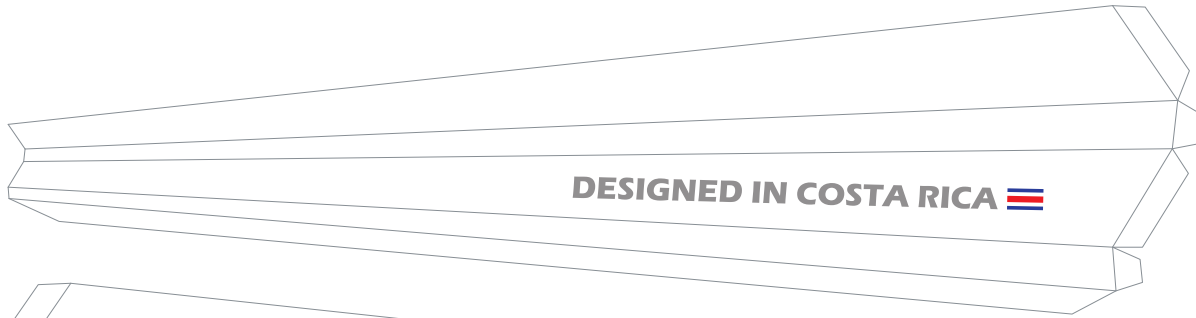

J1L

DESIGNED IN COSTA RICA 



J1R

FREE MODEL, DO NOT SELL THE FILE!!!

