

- B5* 
- B7* 
- B9* 
- B6* 
- B8* 
- B10* 

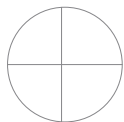

B3

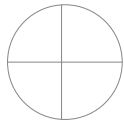
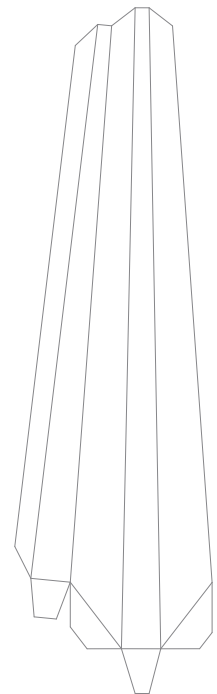

B13

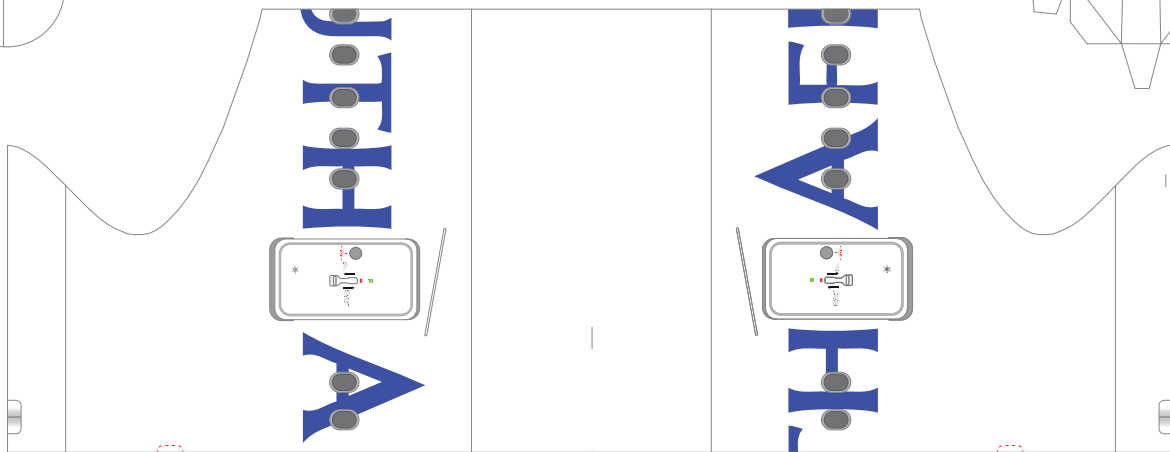

B2

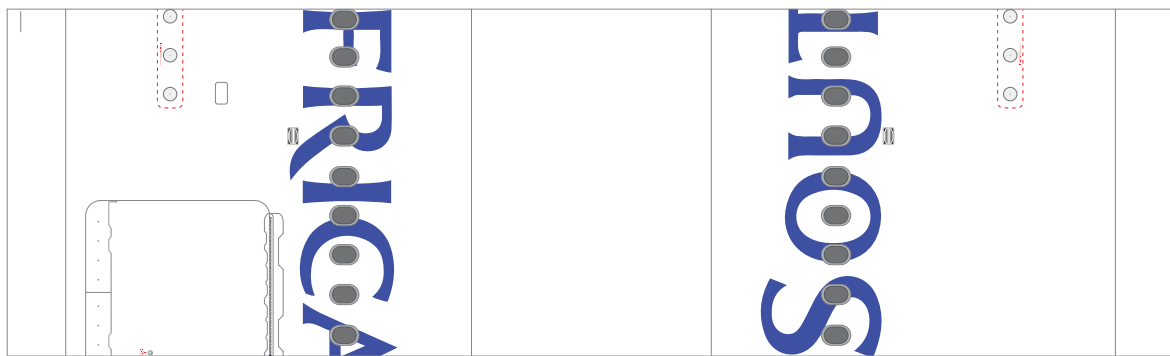

B1



B12R

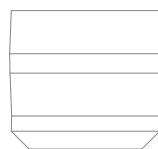

B11



B12L

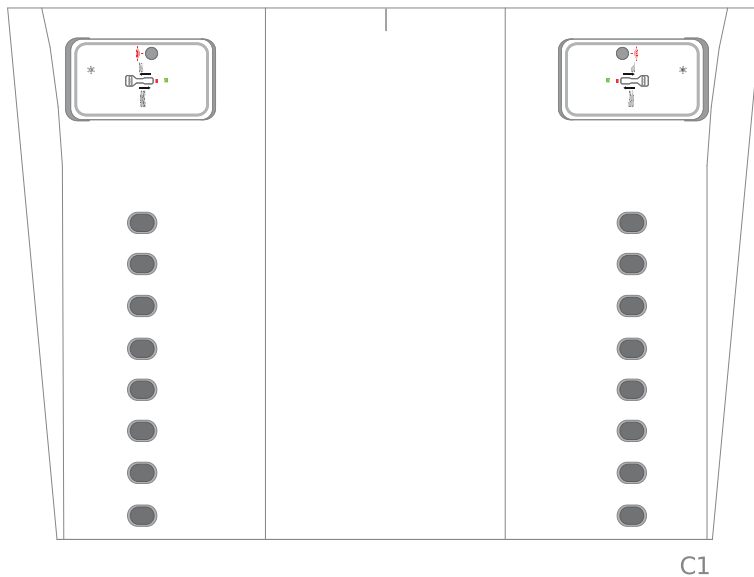
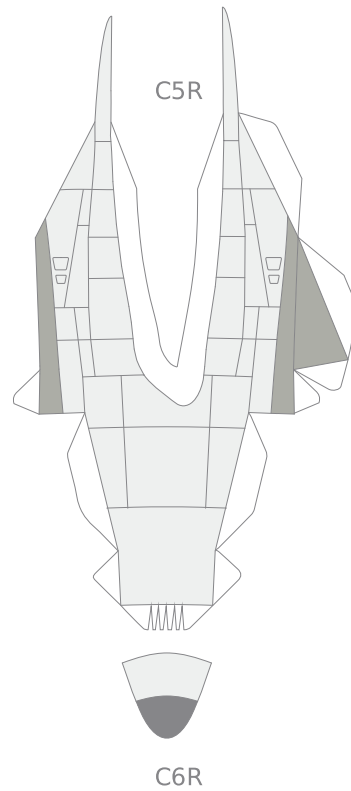
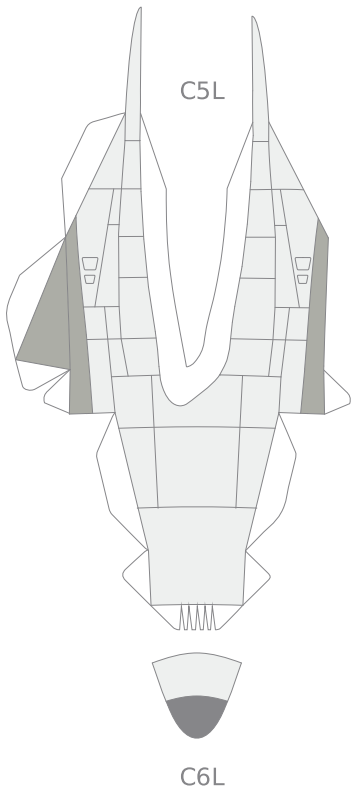
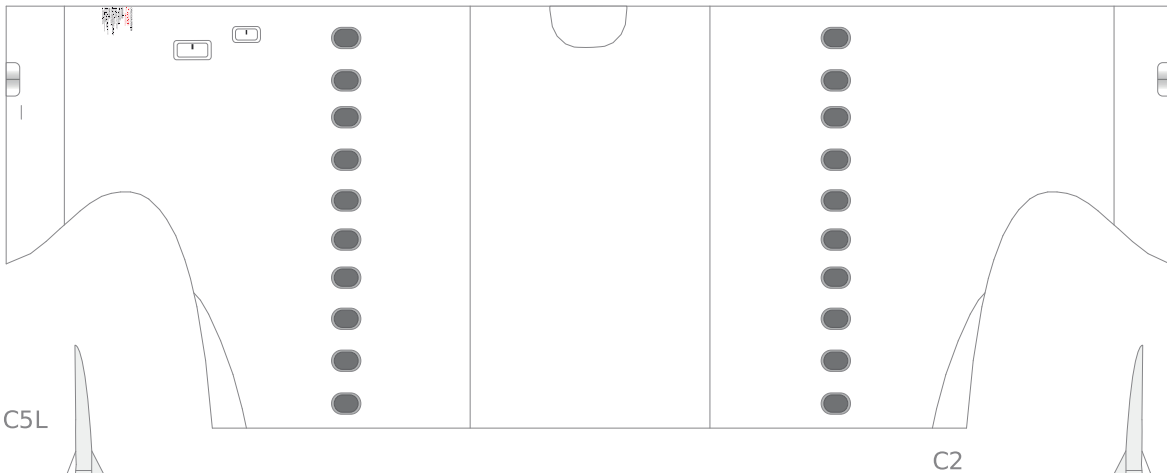
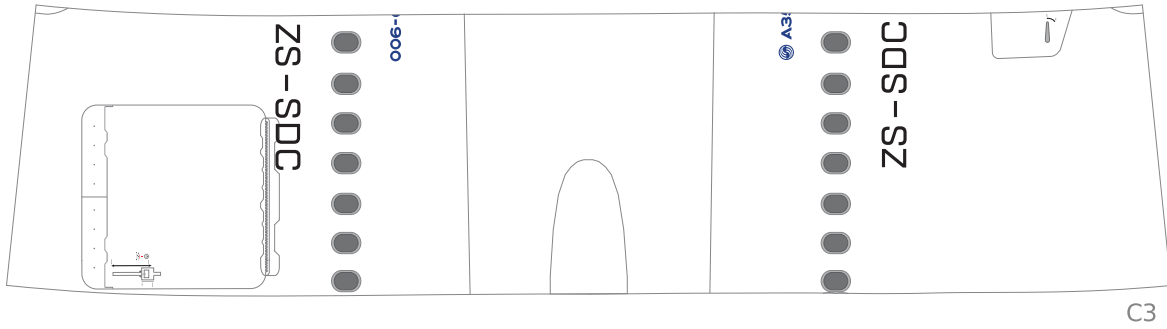
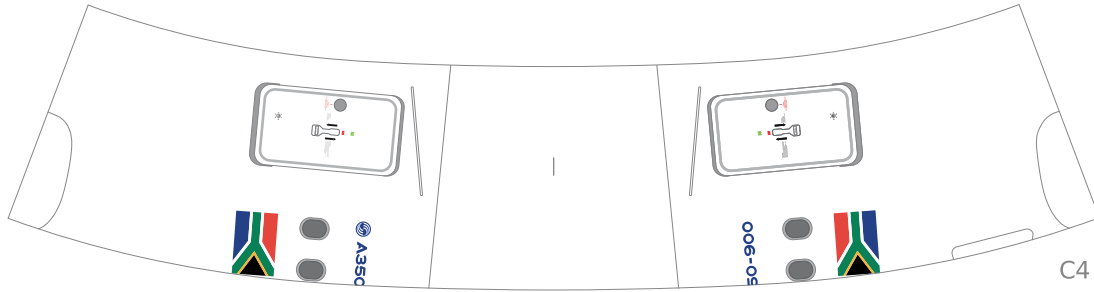

C6L

C6R

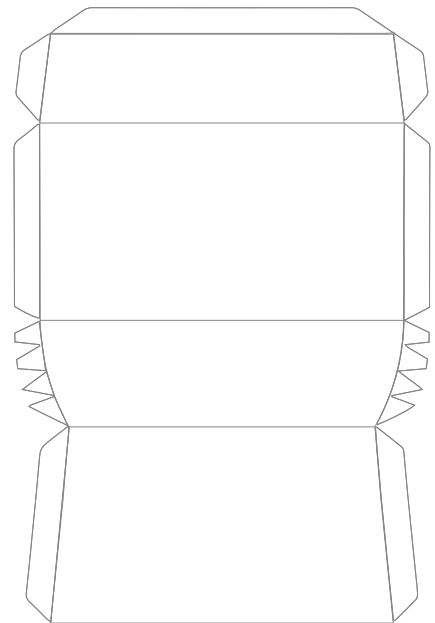
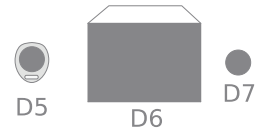
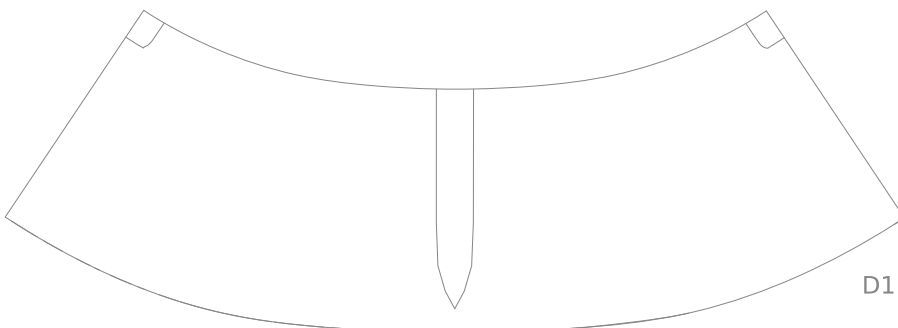
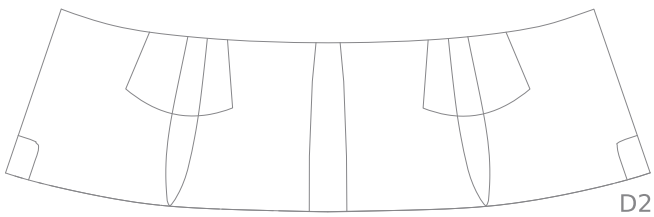
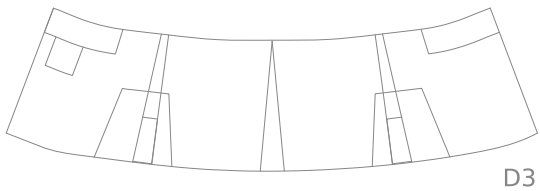
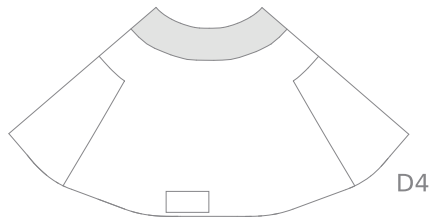
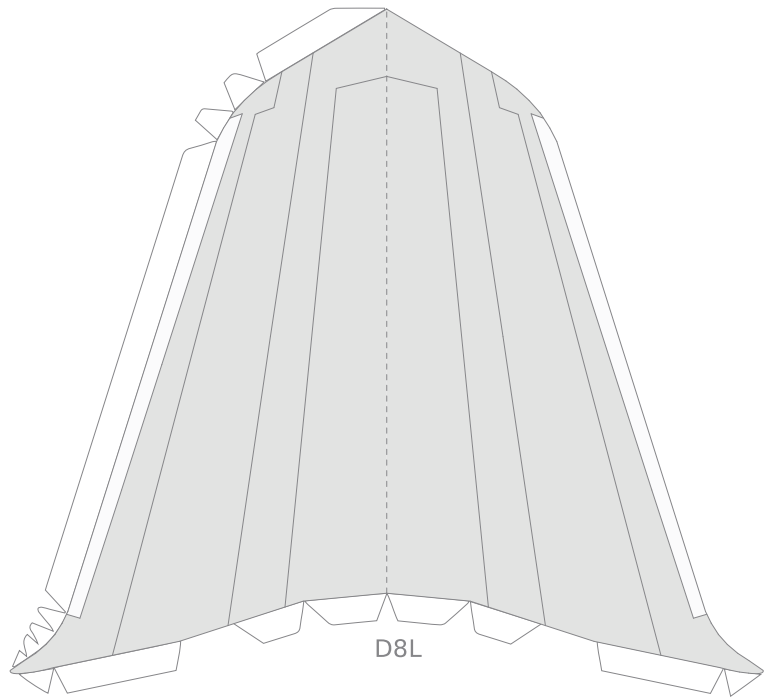
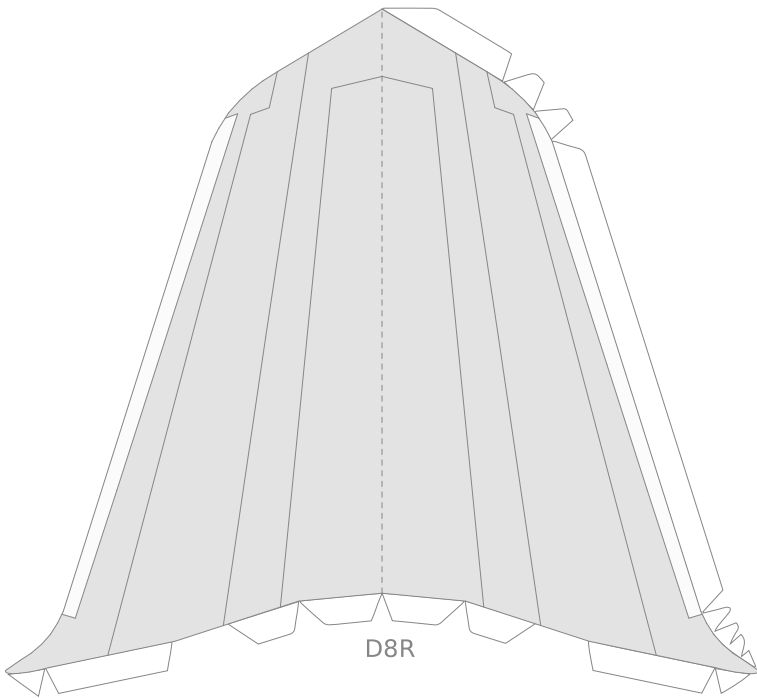

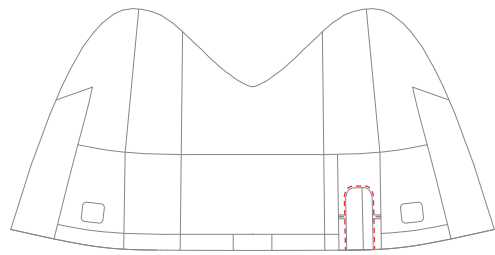
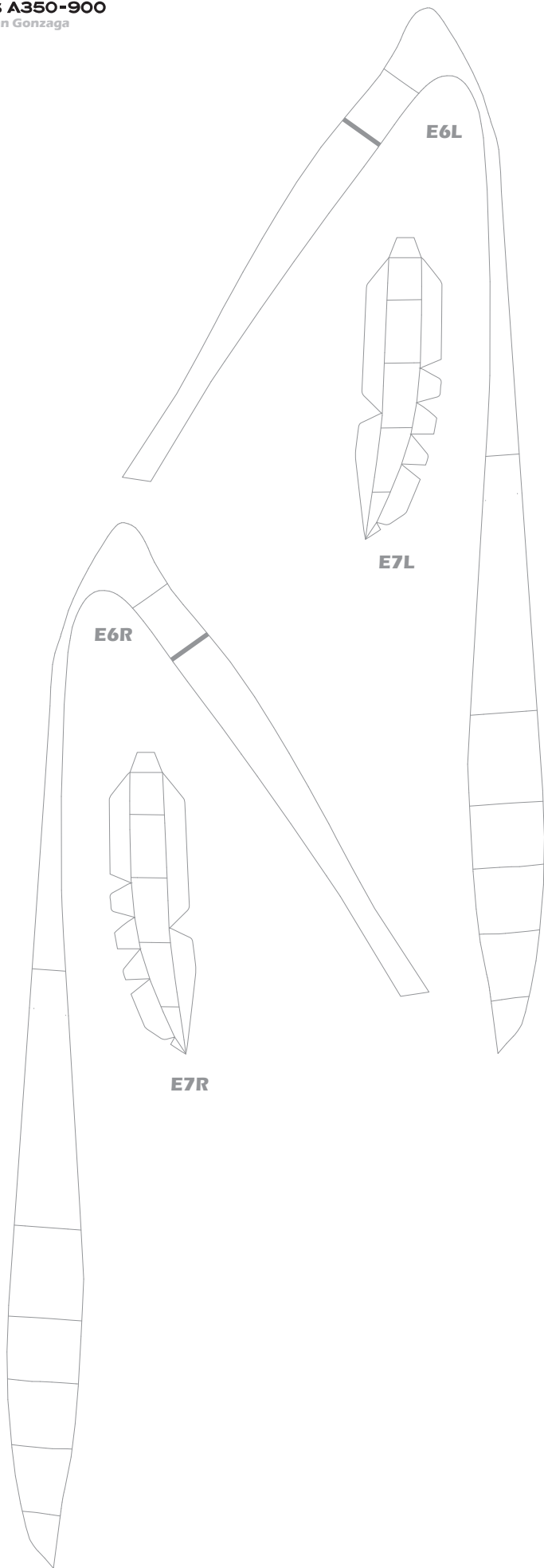

E5

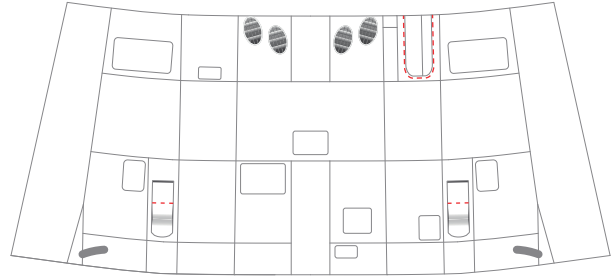

E4

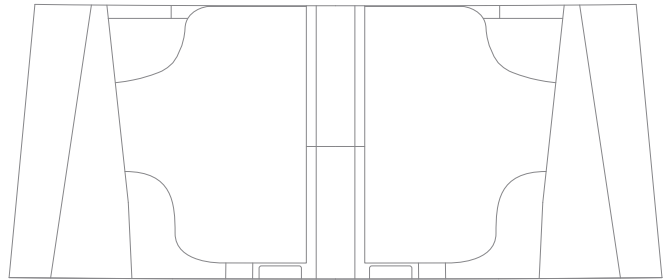

E3

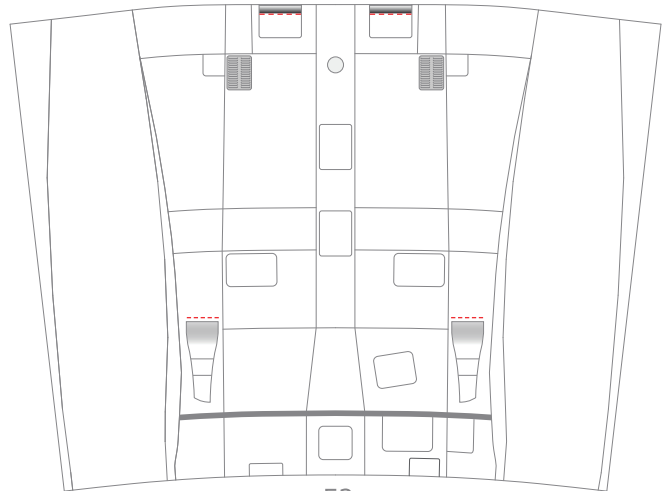

E2

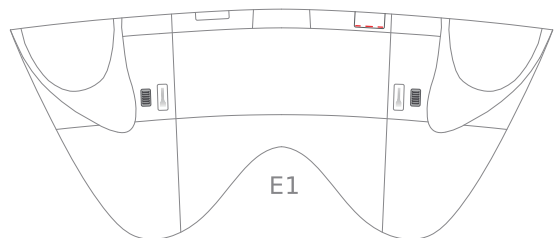

E1

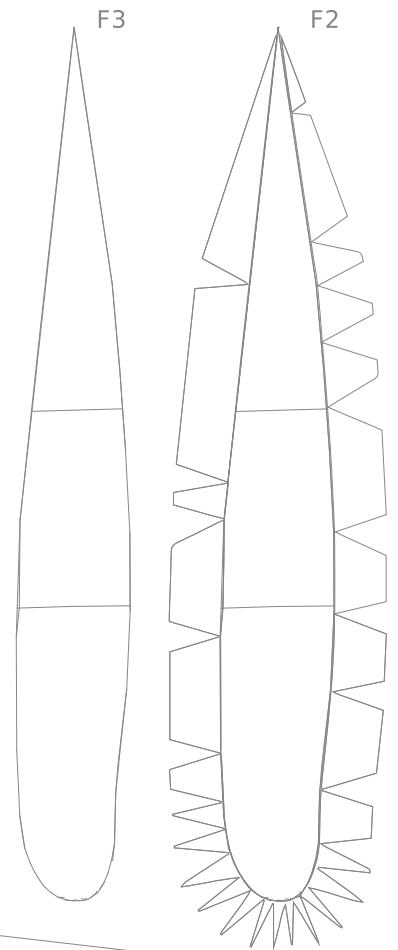
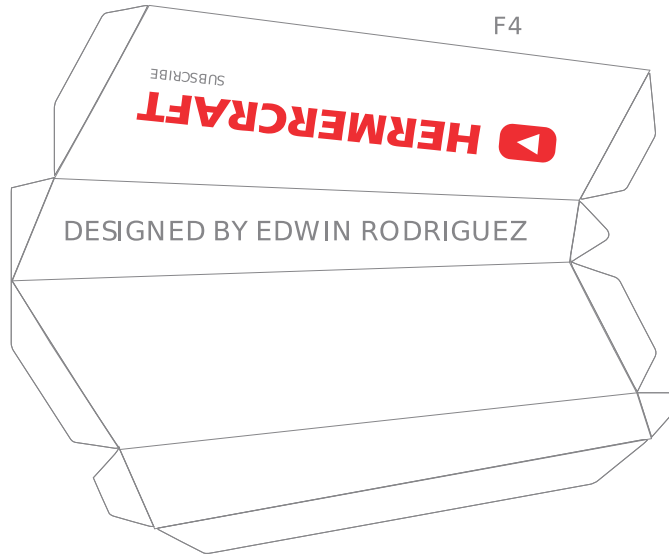
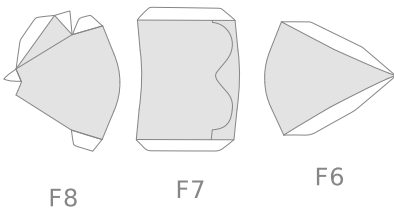
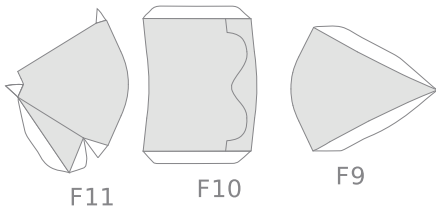
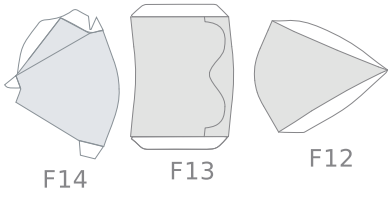
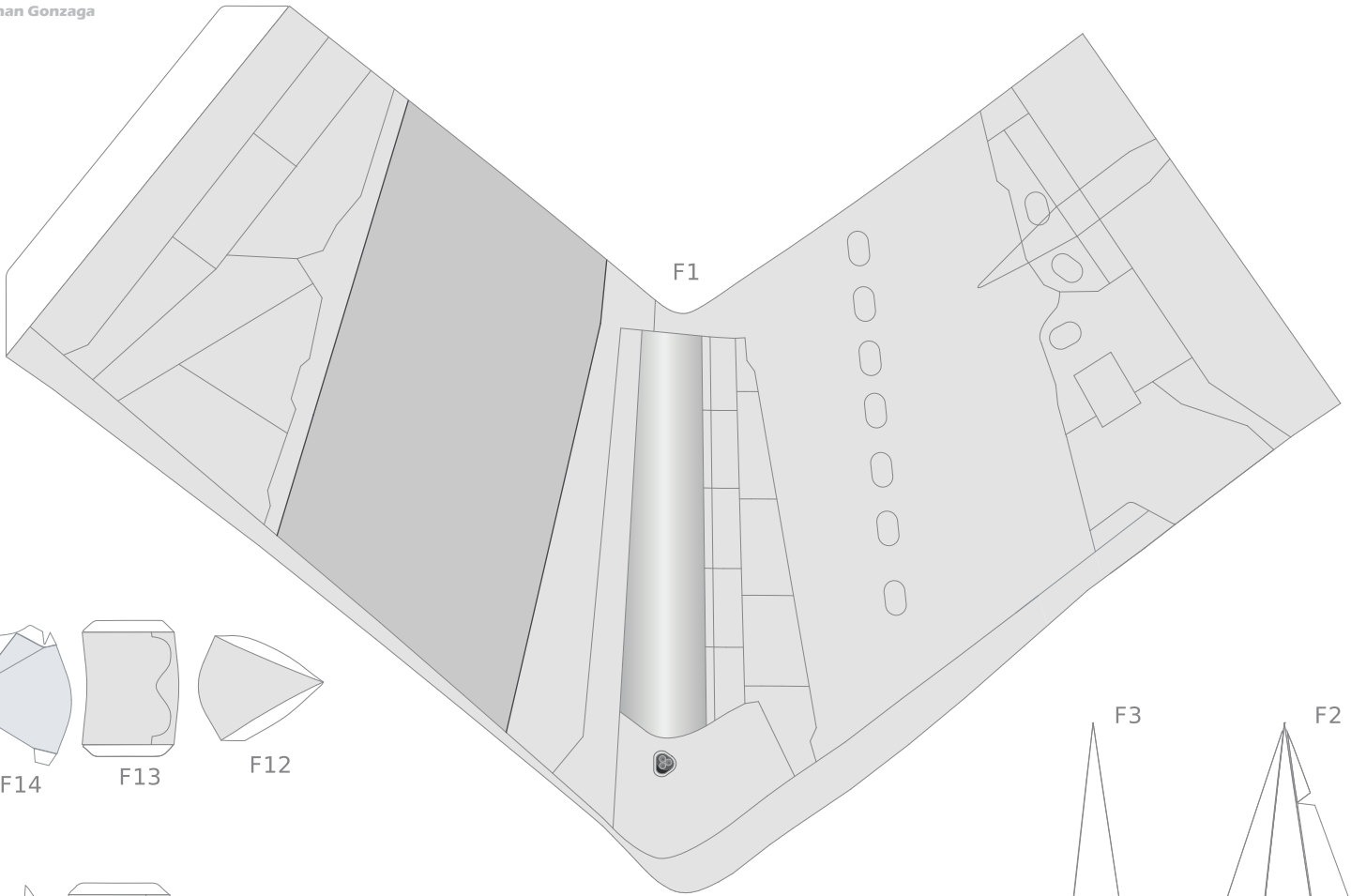

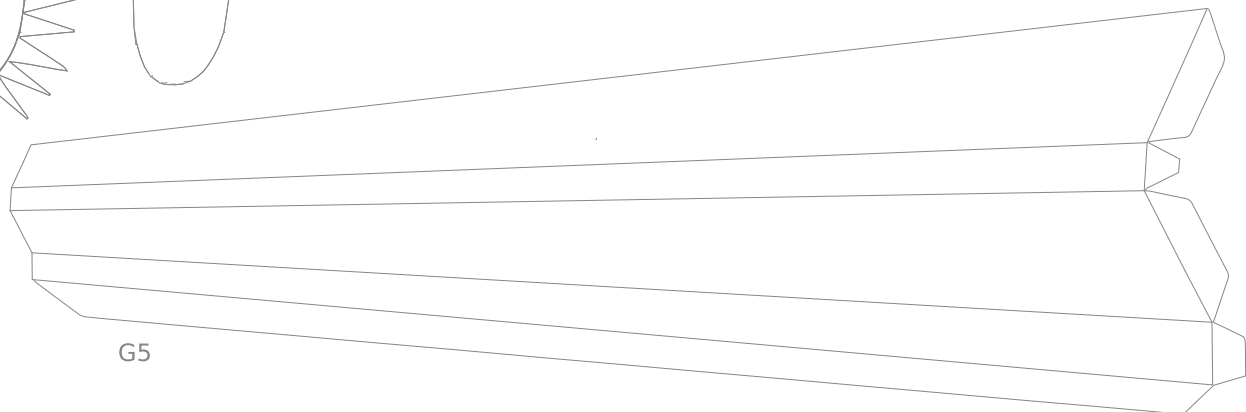
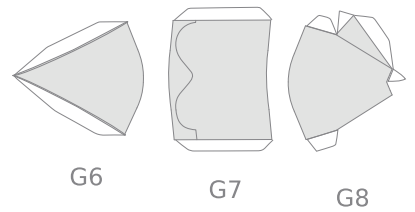
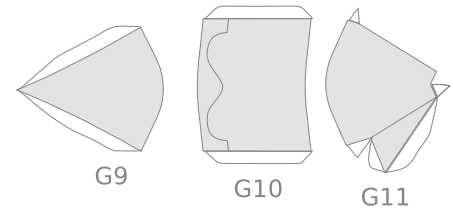
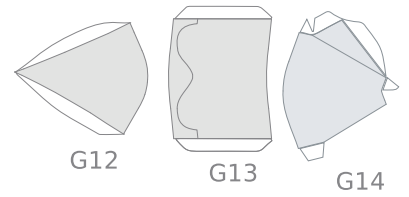
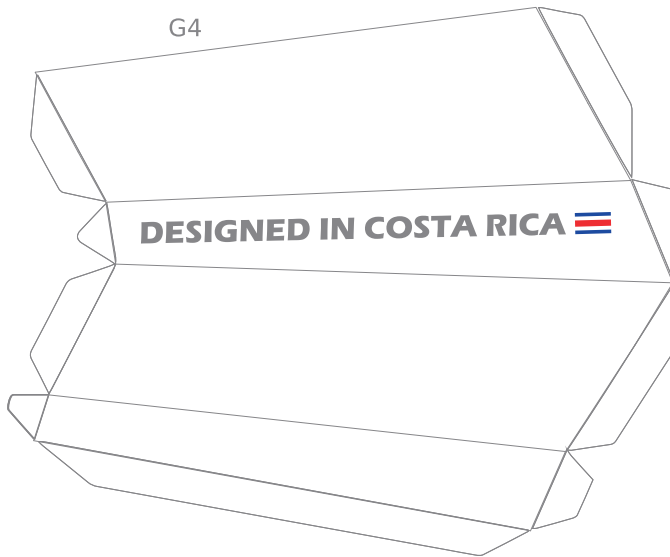
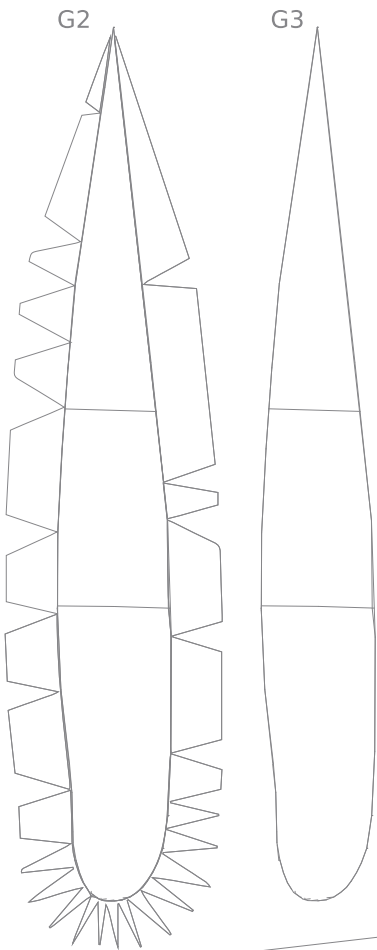
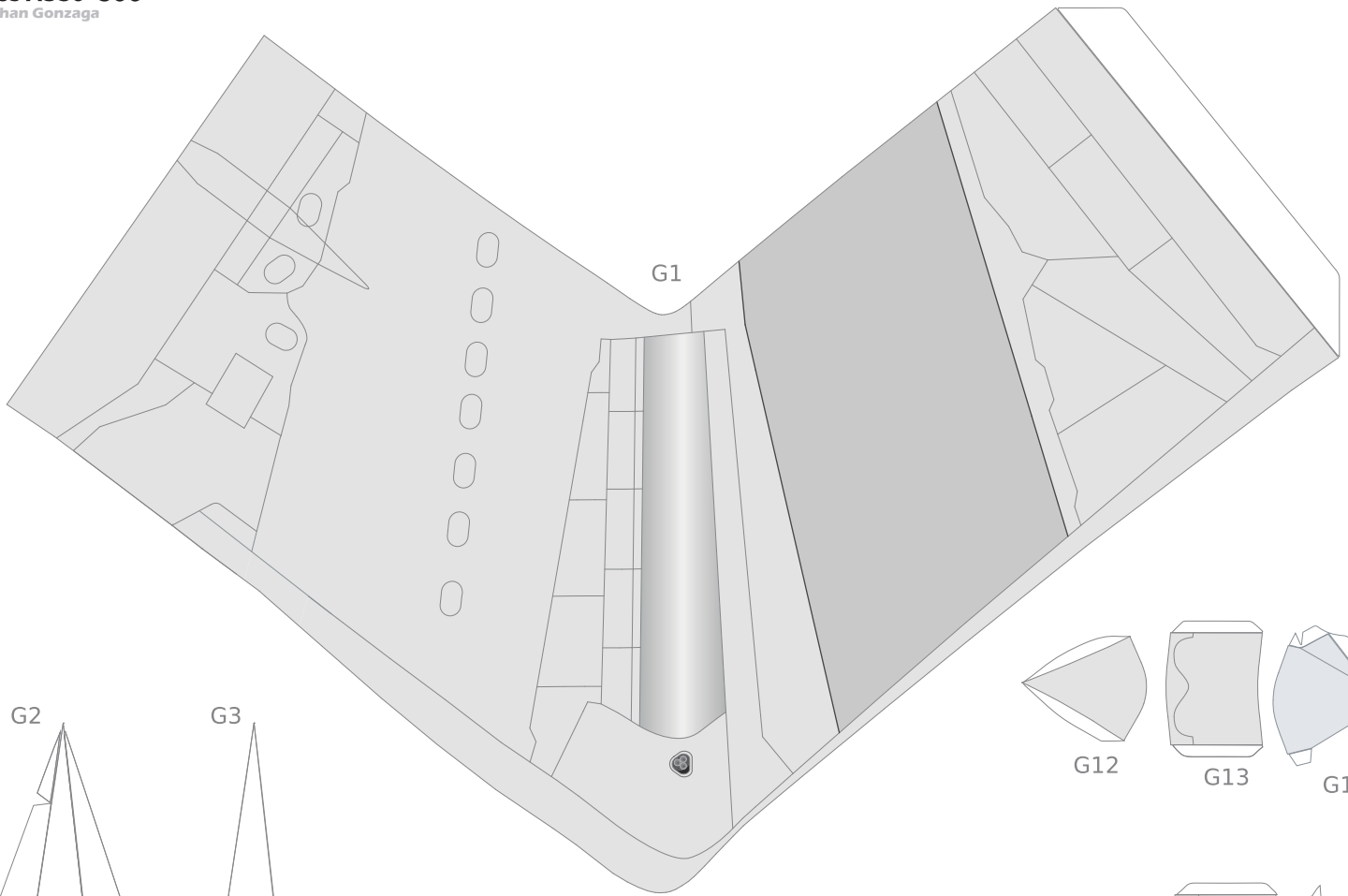

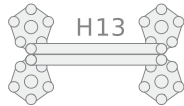
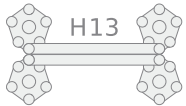
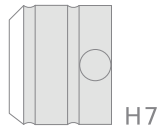
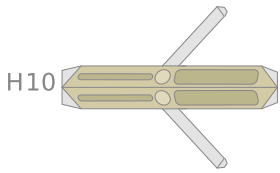
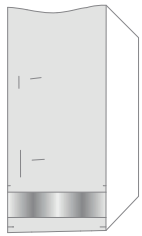
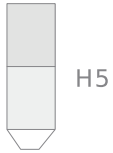
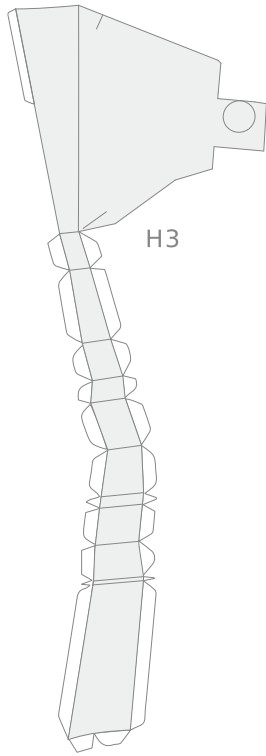
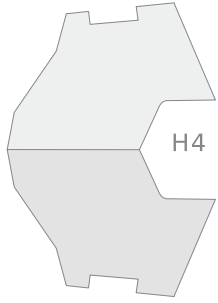
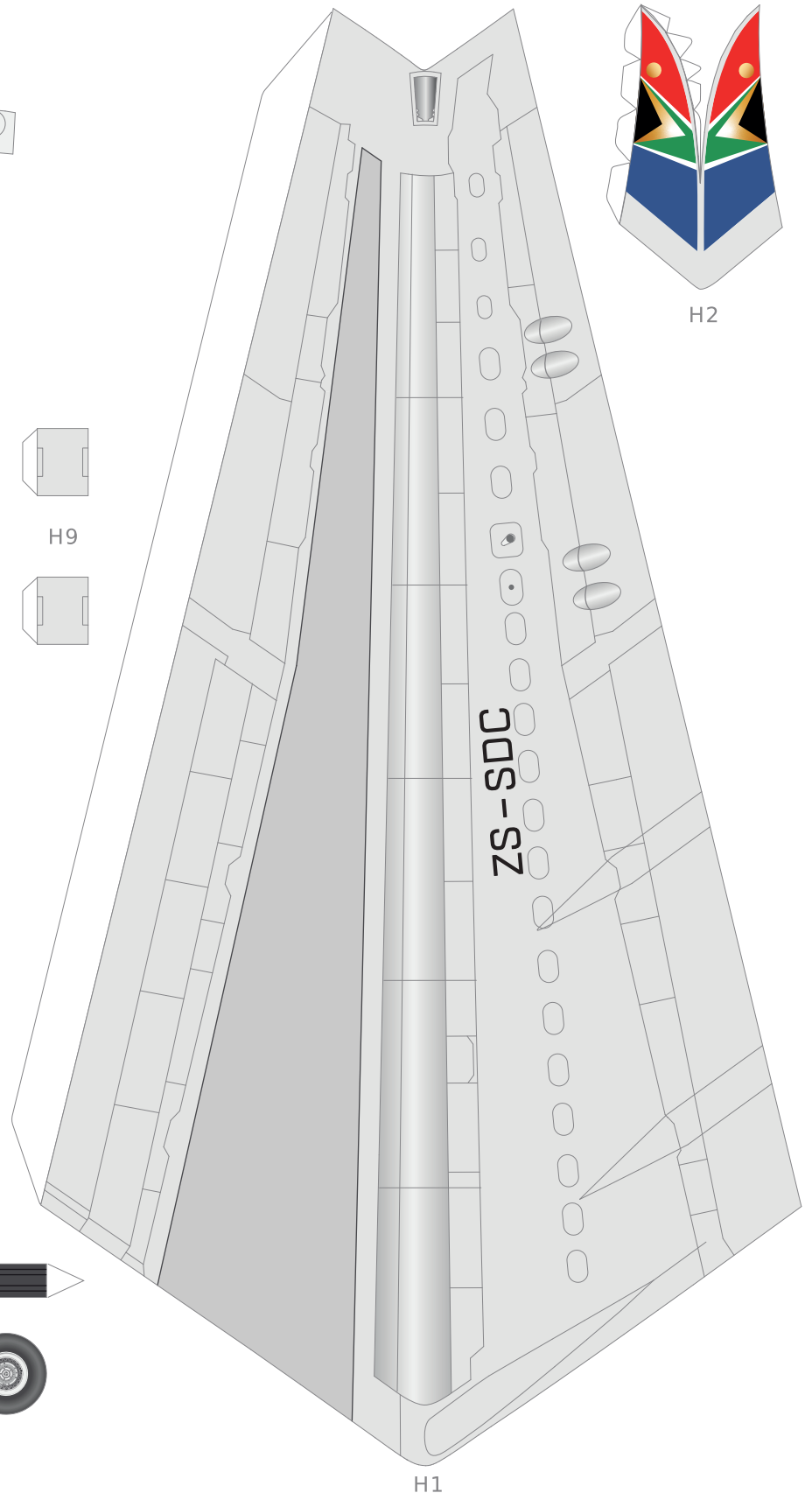
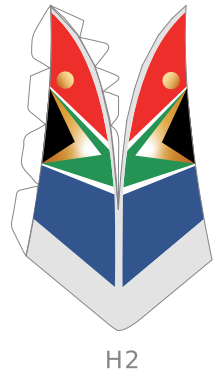



12

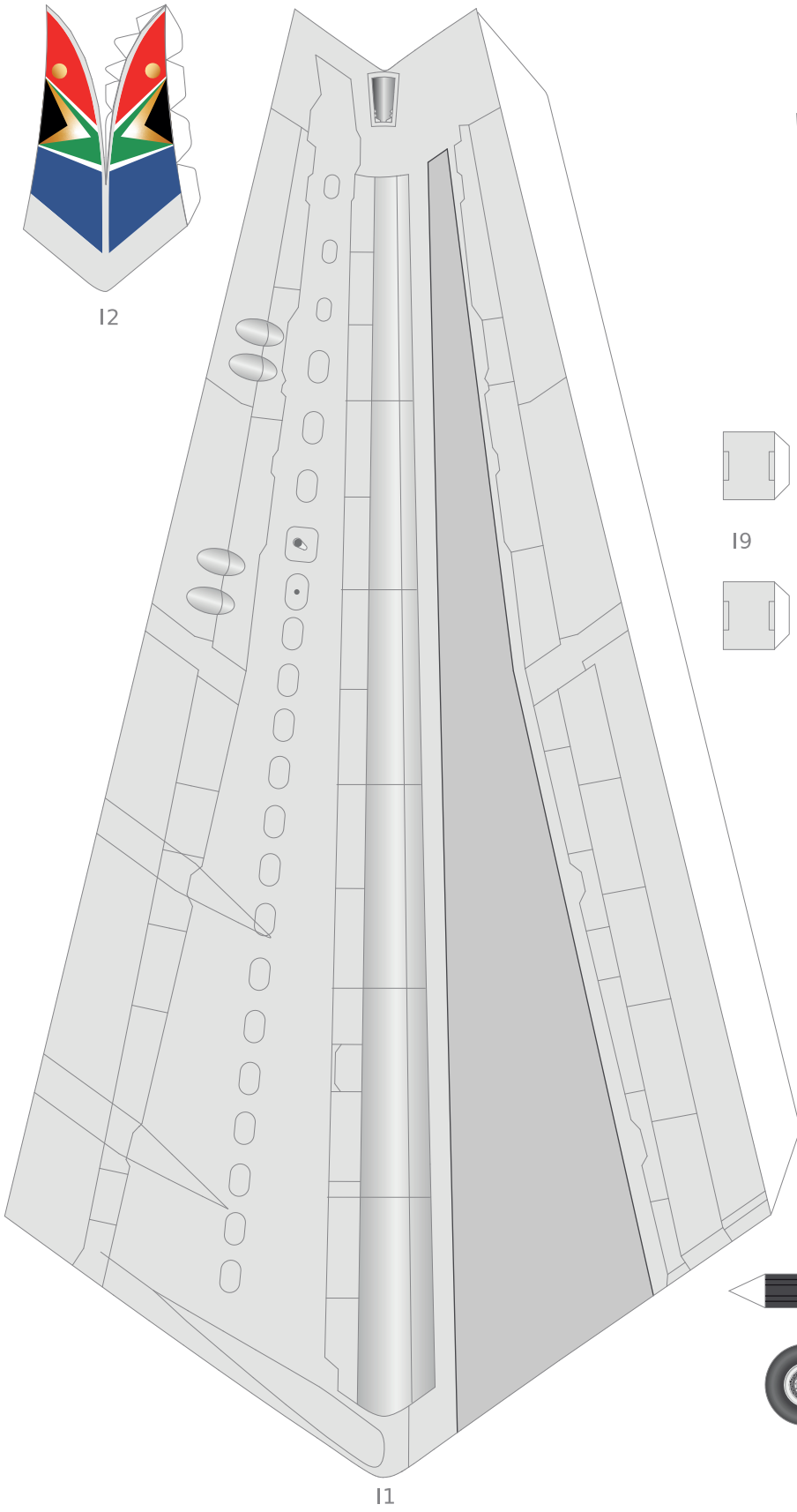

11

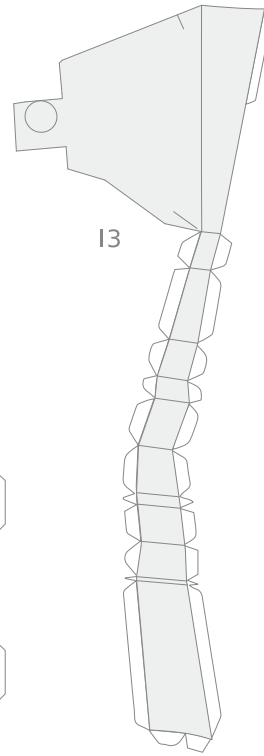

13

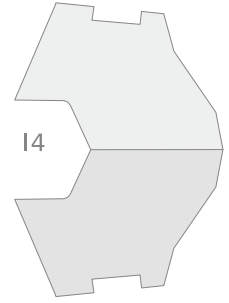

14



19

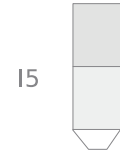

15



18



16

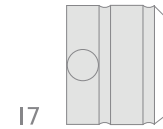

17

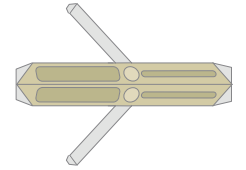

110



112



111

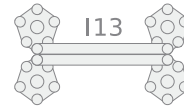

113

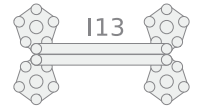

113



114



115



114



115



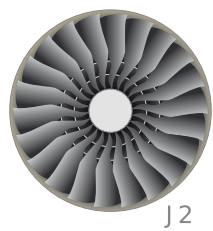
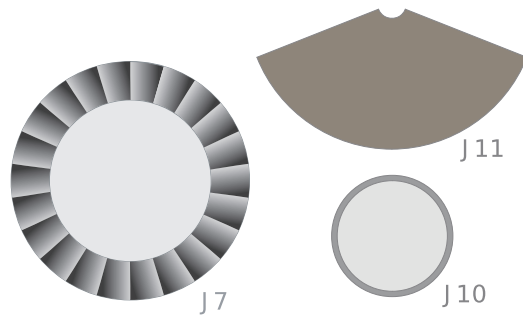
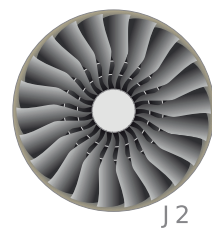
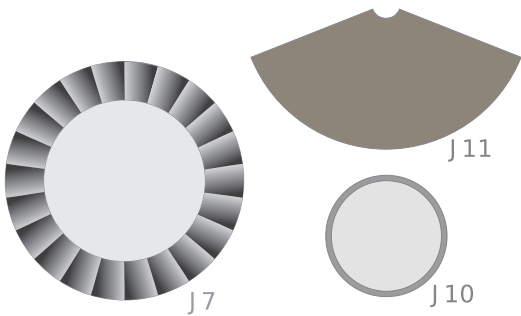
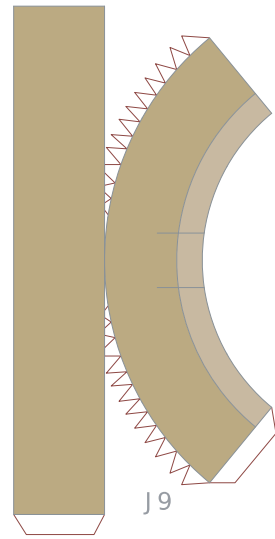
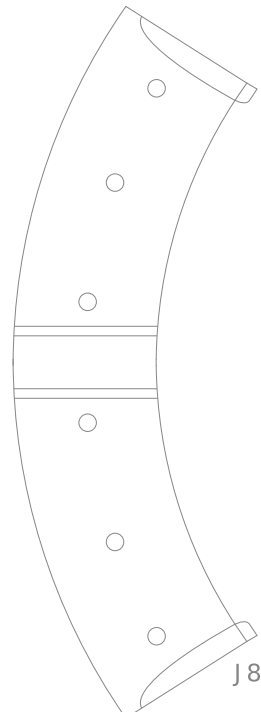
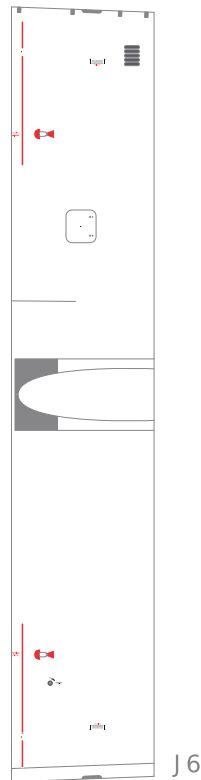
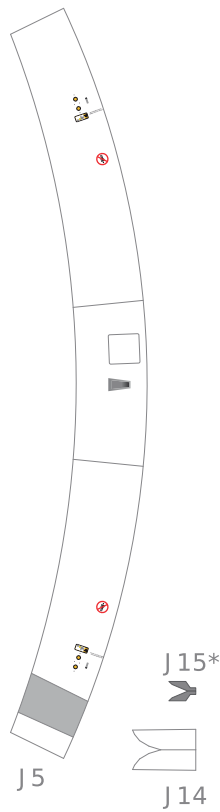
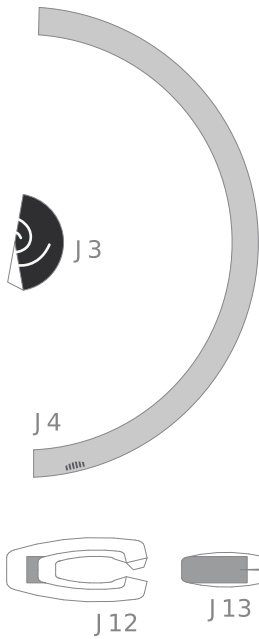
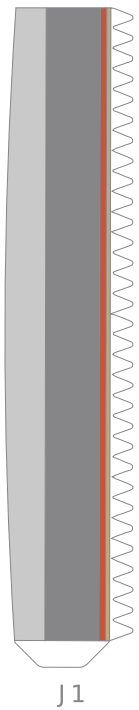
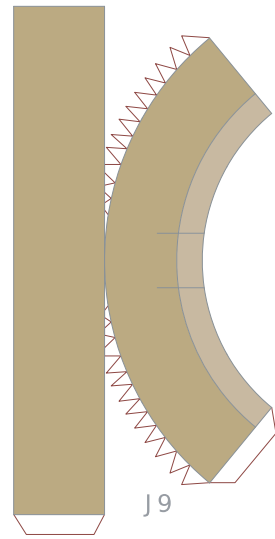
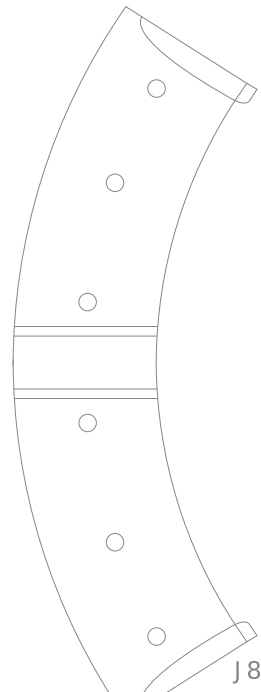
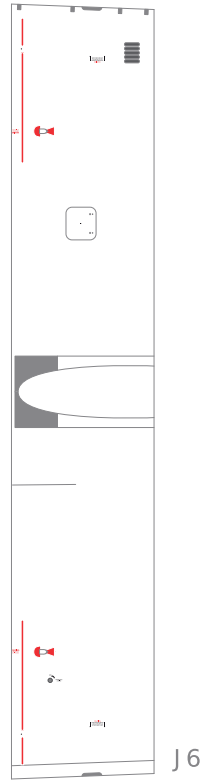
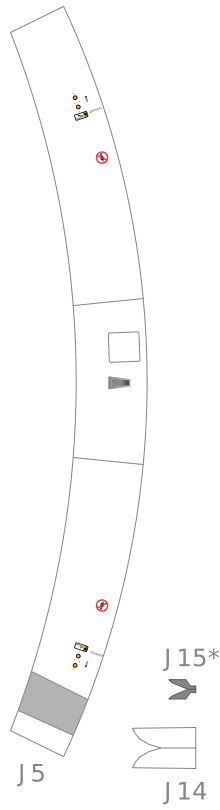
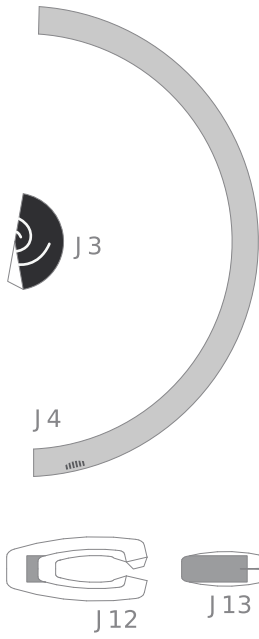
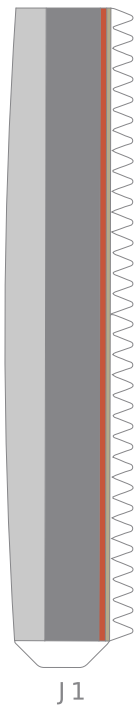

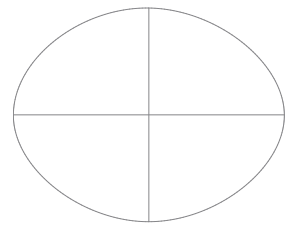
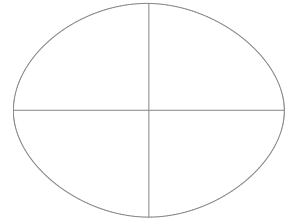
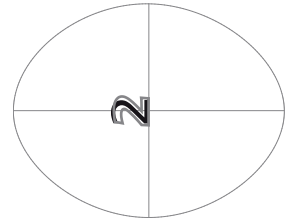
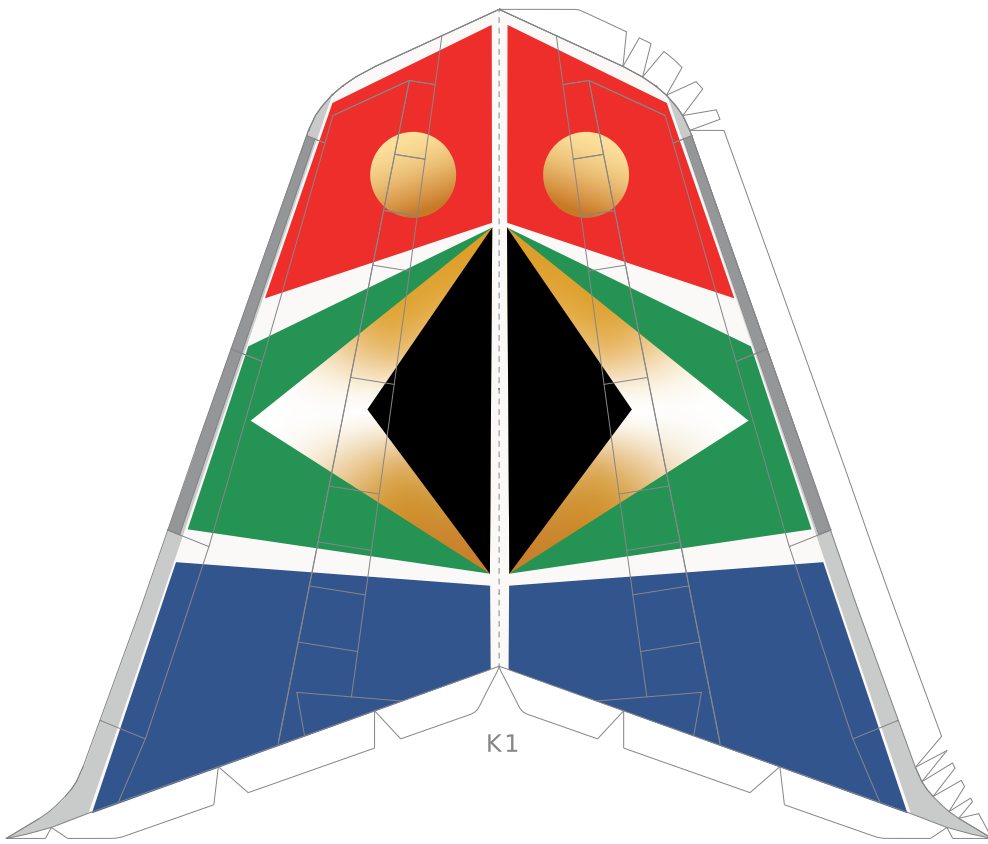

K2

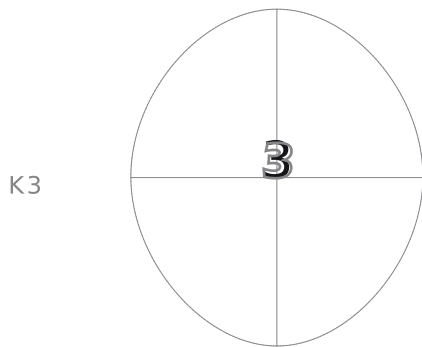

K3

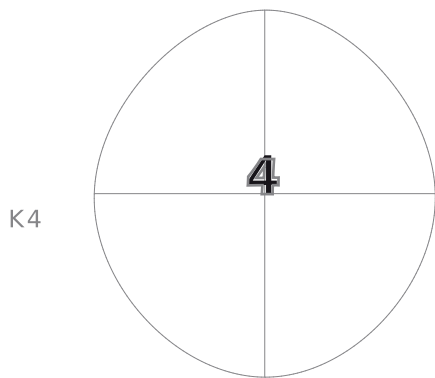
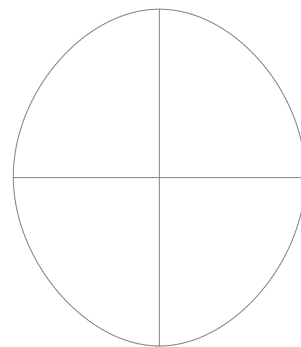
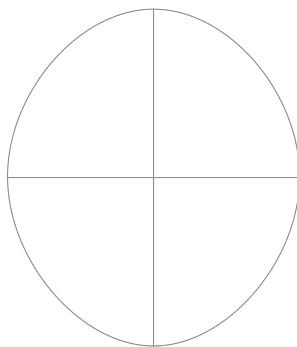

K4

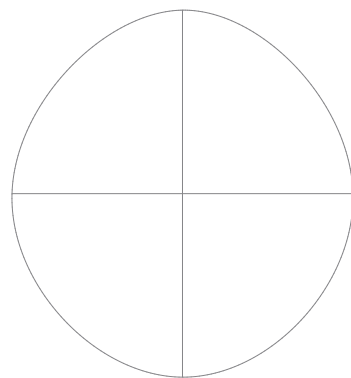
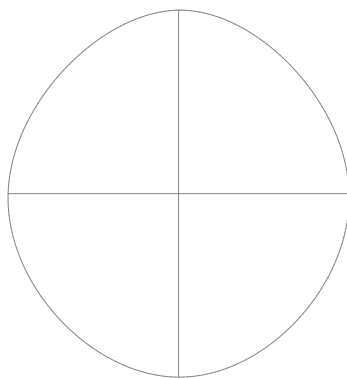

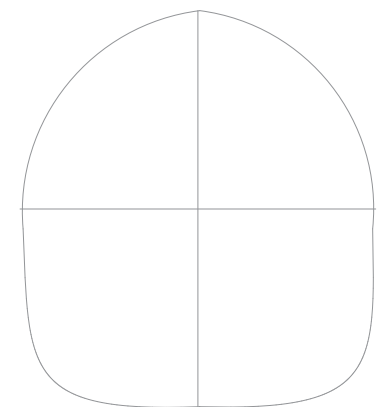
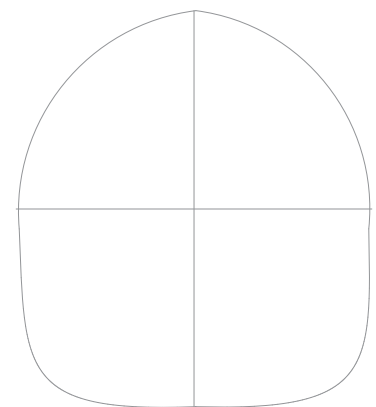
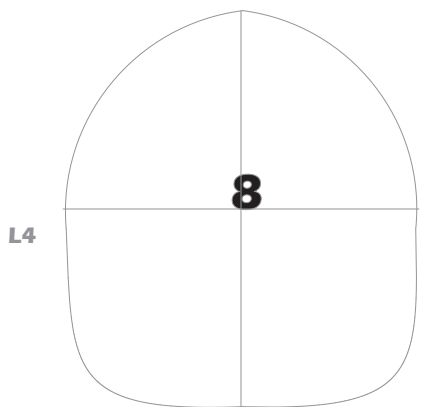
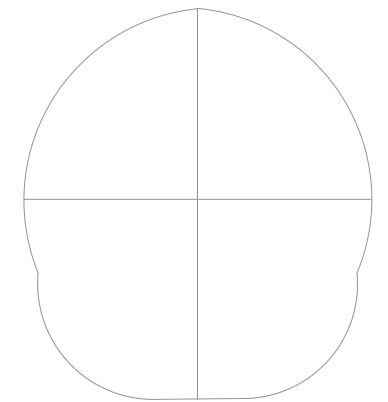
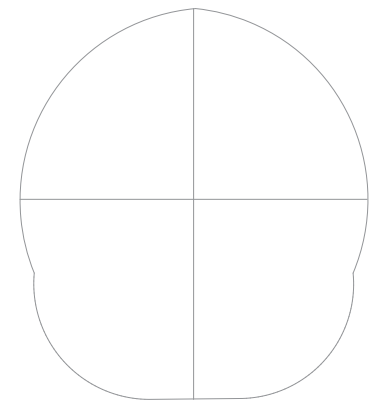
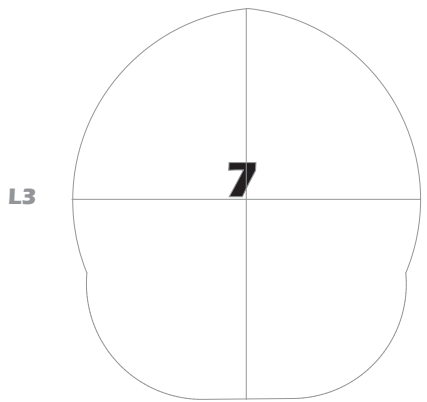
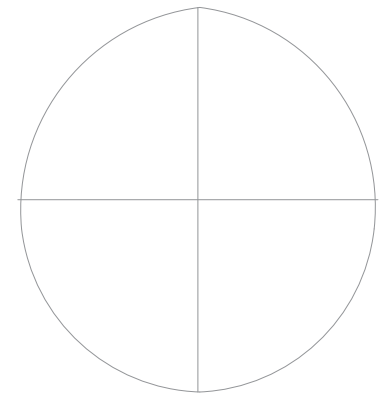
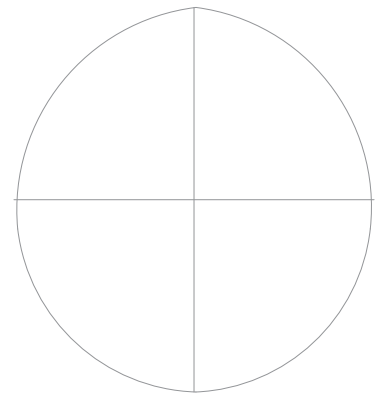
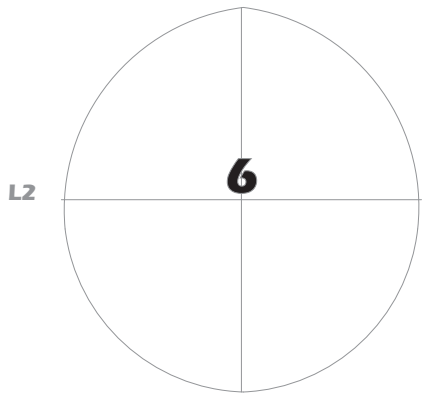
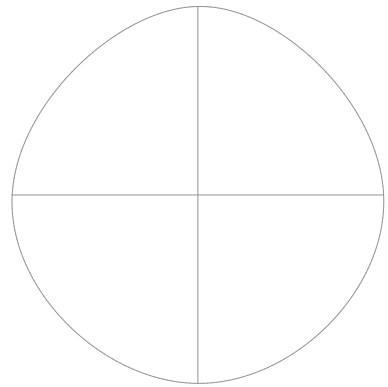
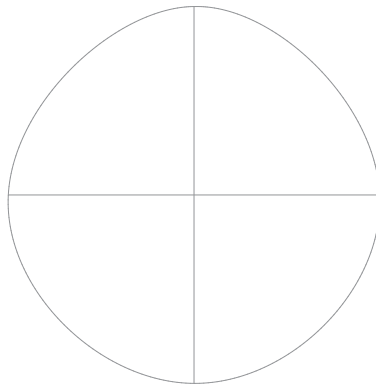
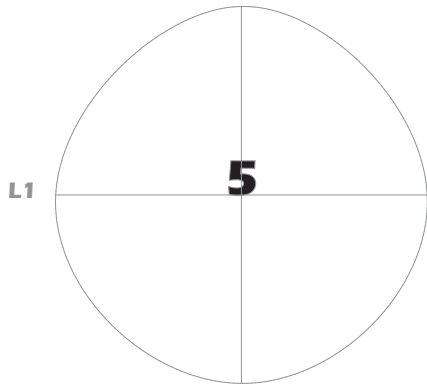

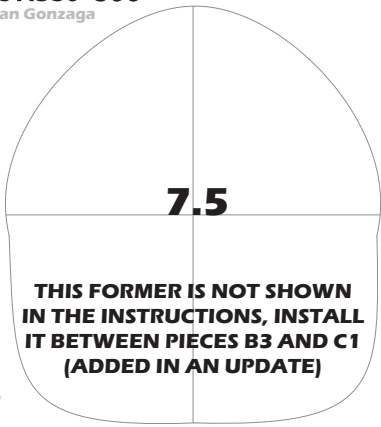

M7

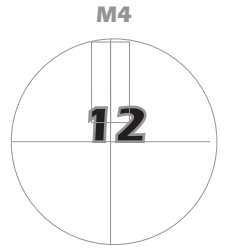
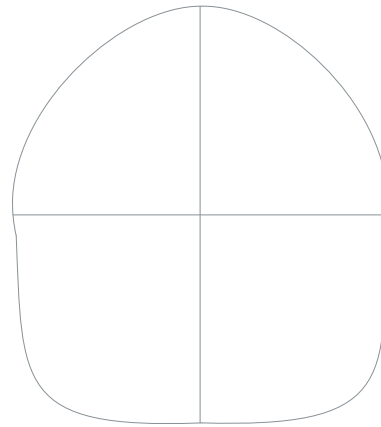
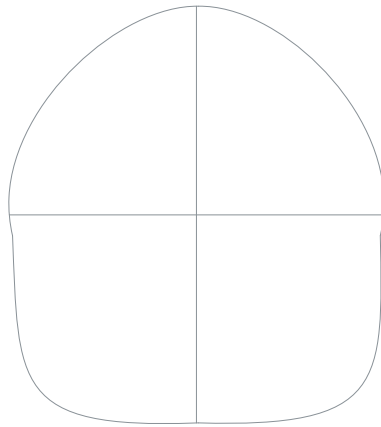

M4

12

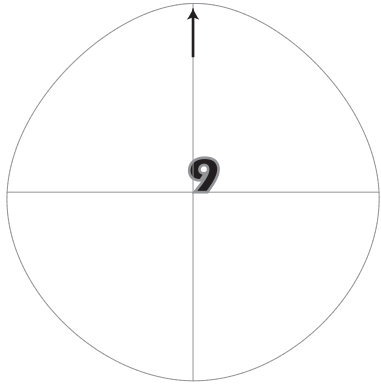
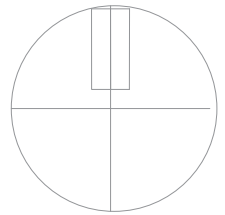
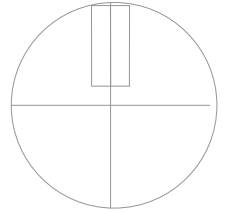

M1

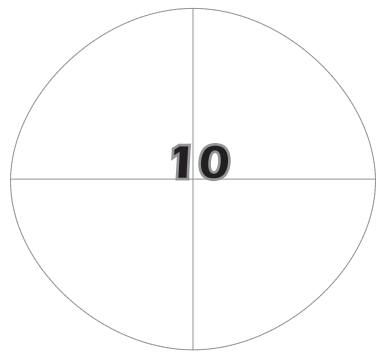
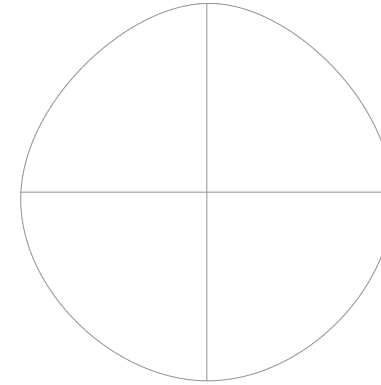
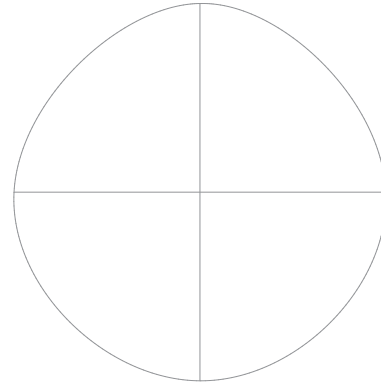

M2

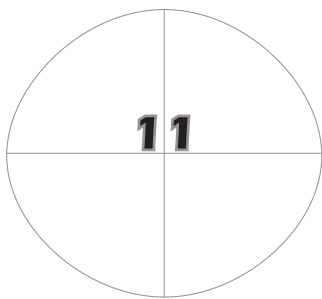
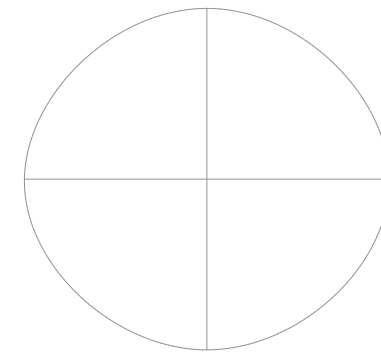
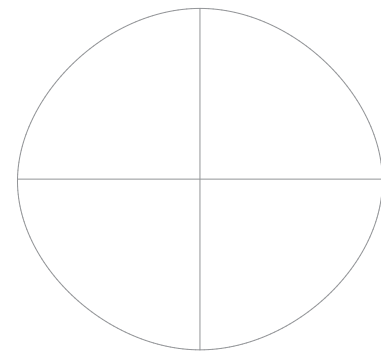

M3

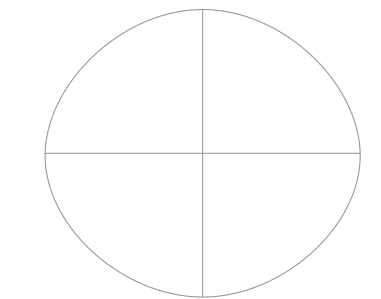
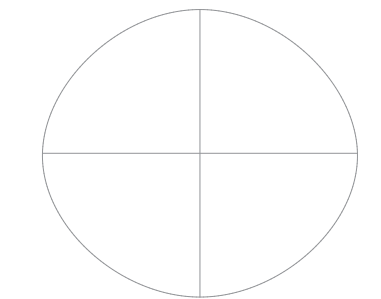

M5

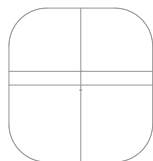
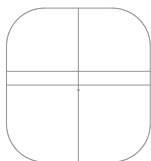

M6



14



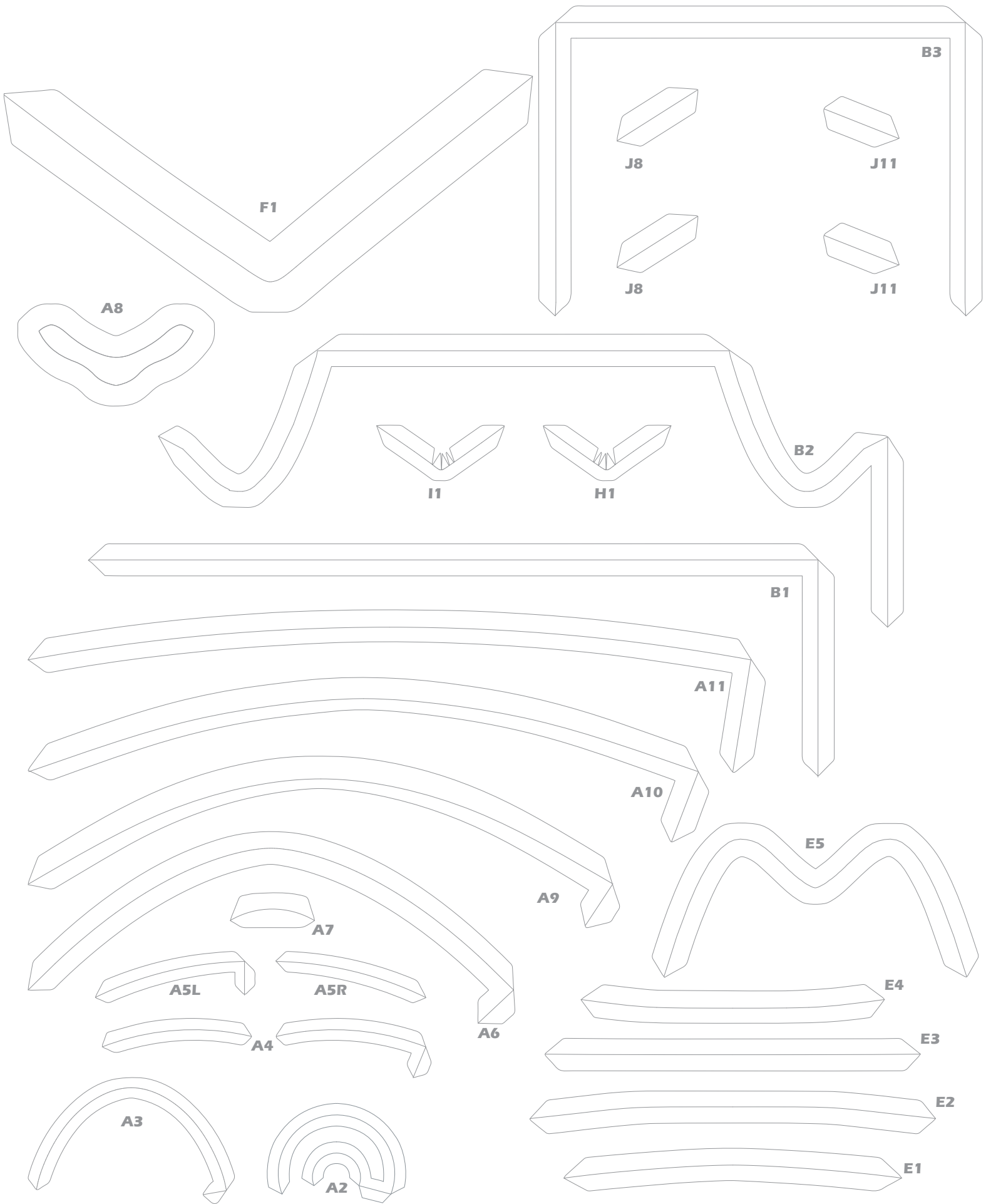

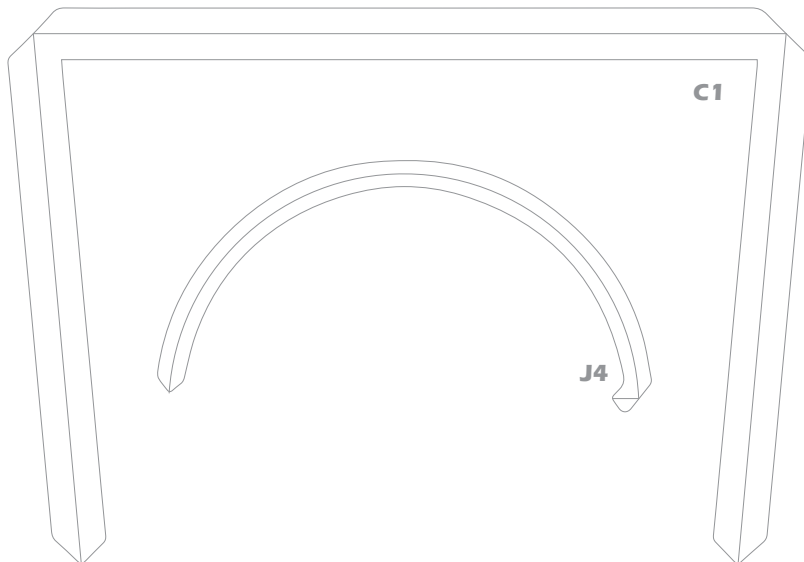
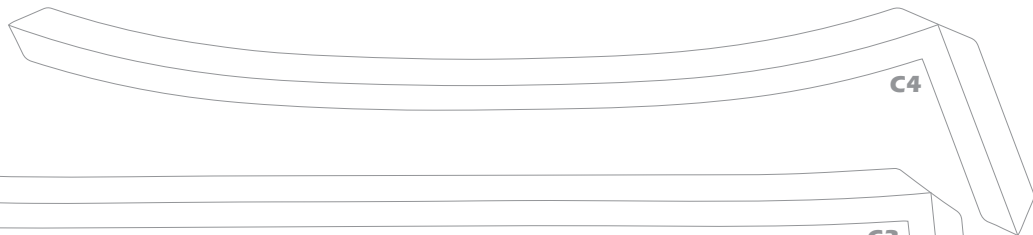
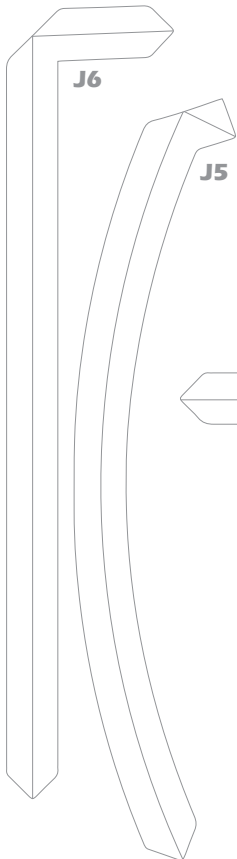
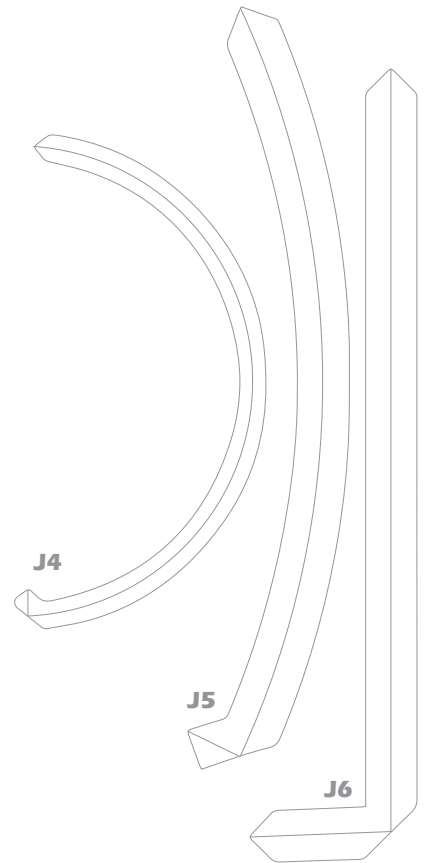
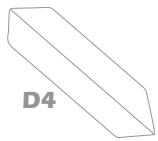
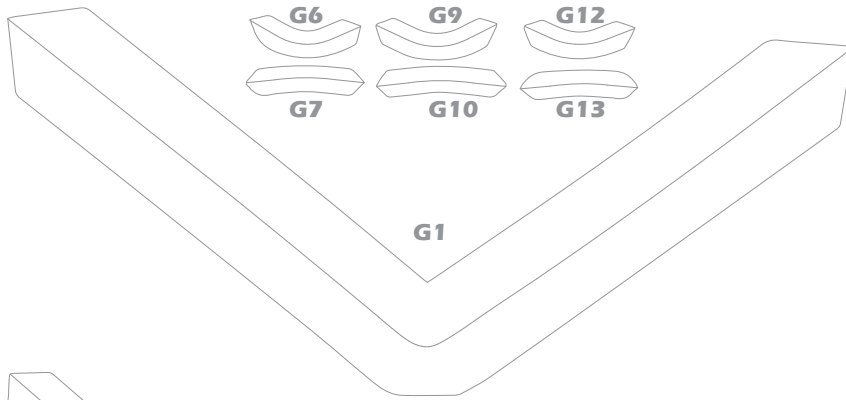
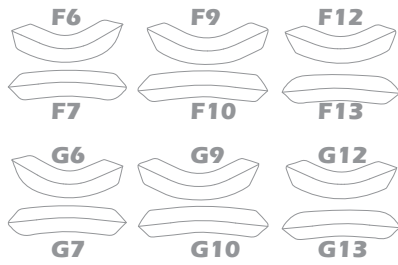

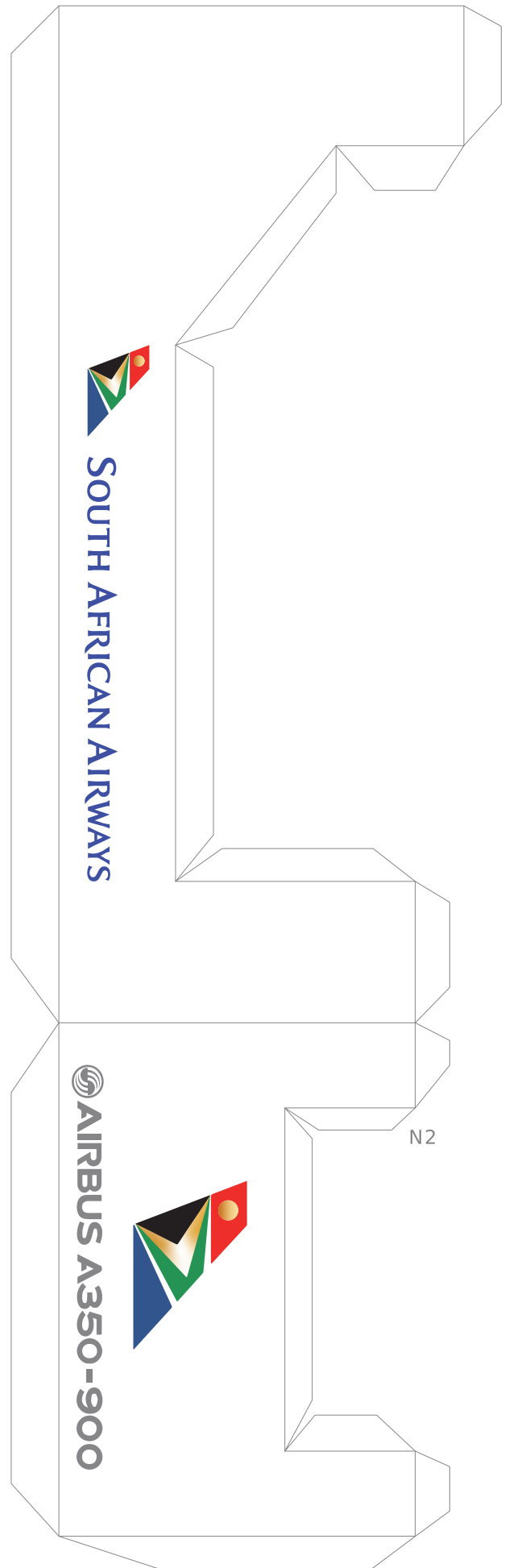
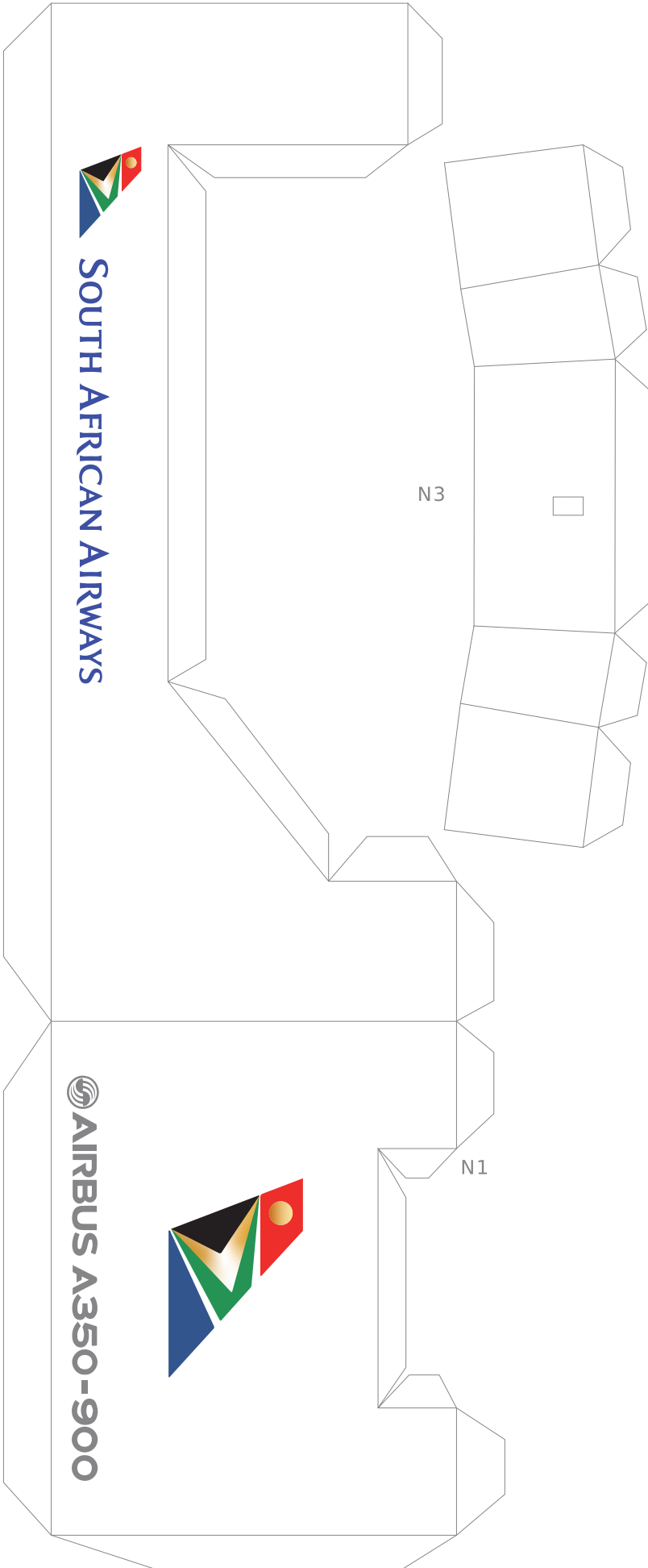

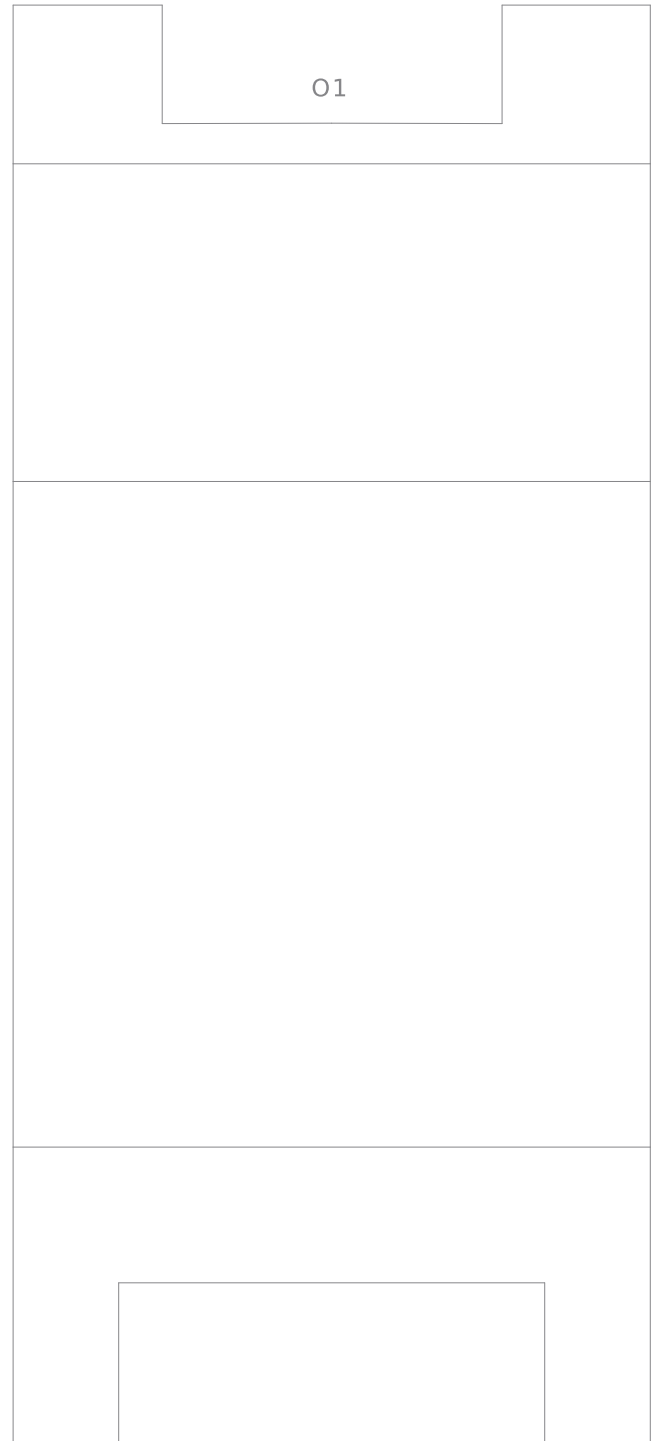

O3

PLEASE DO NOT SELL THIS FILE | DESIGNED IN PALMARES, COSTA RICA

HERMERCRAFT

ORIGINAL MODEL DESIGNED BY EDWIN RODRIGUEZ