

Blank space for 787-10 variant

Instructions



Scan

A14

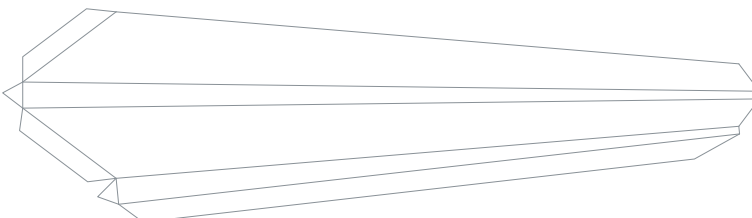

A16L

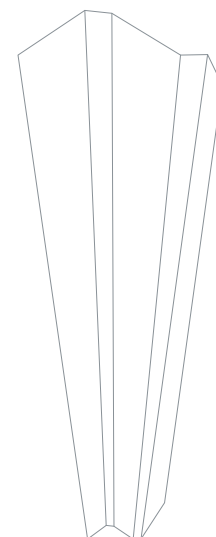

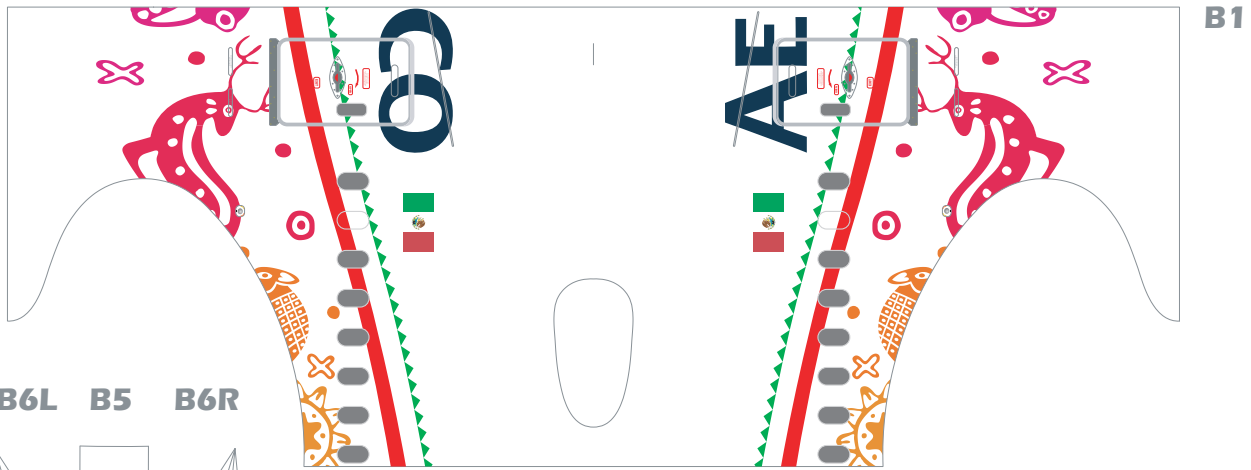

B6L B5 B6R

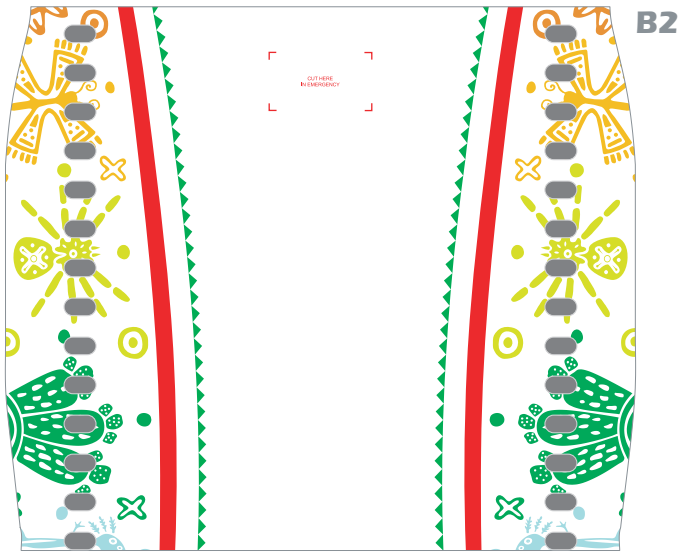
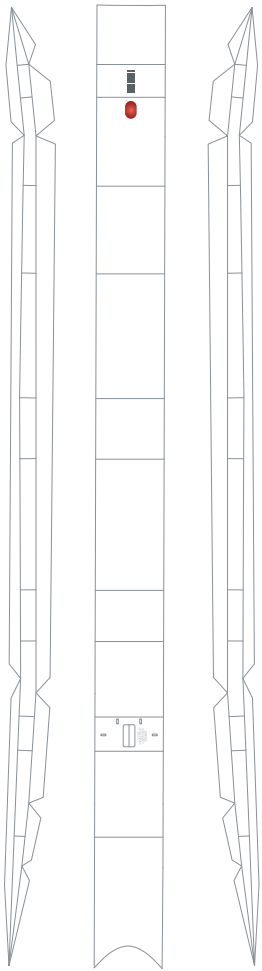

B4

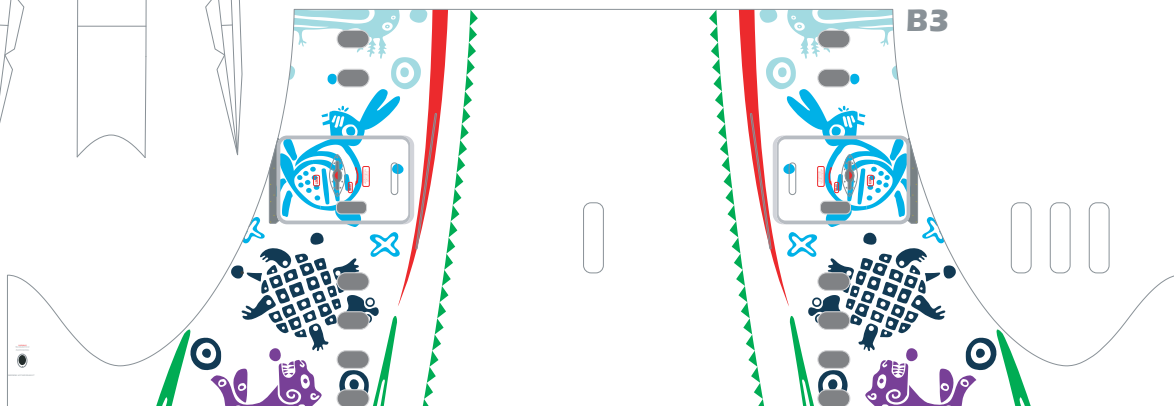
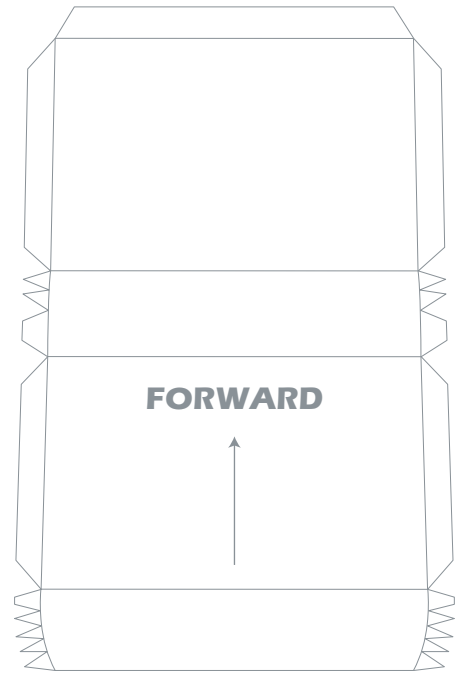

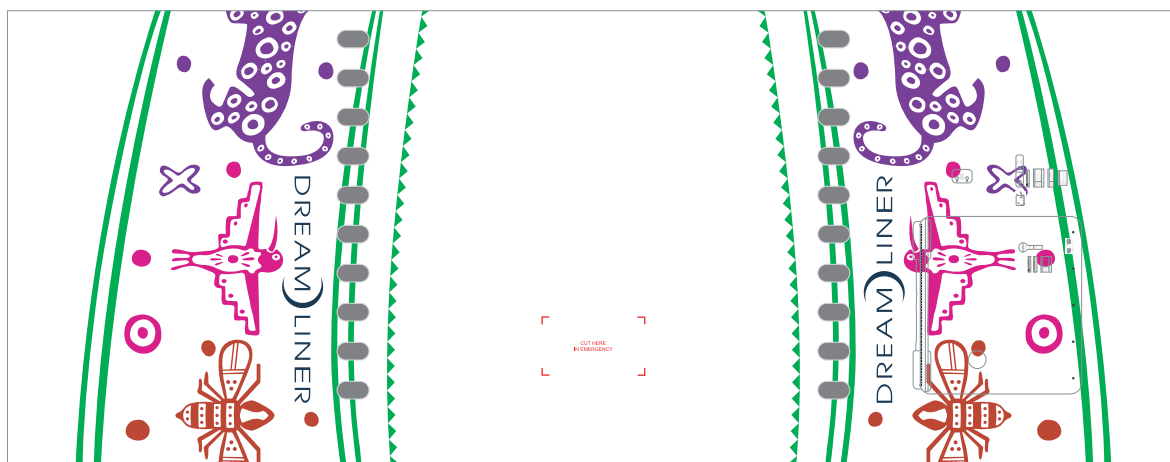

Blank space for 787-10 variant

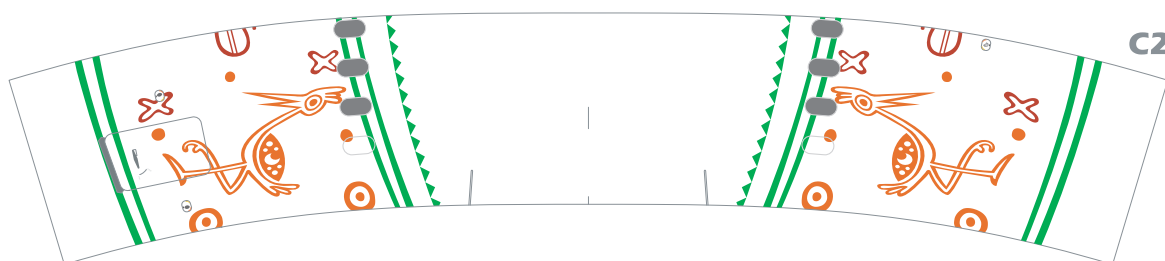
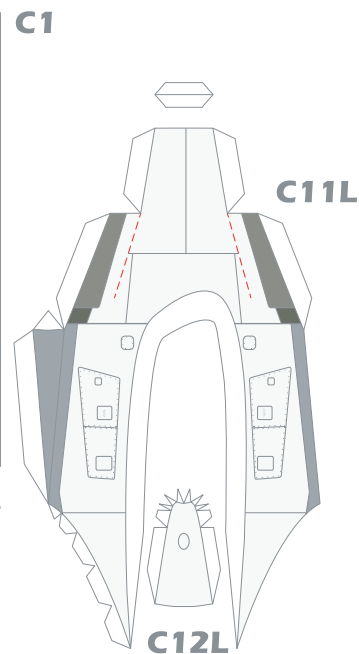

C2

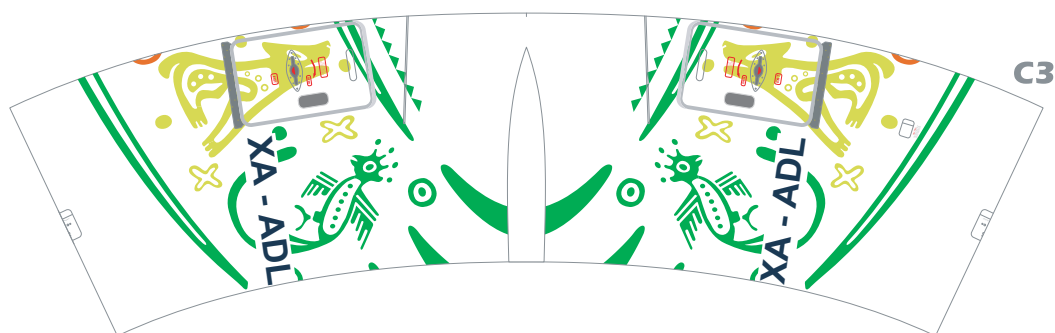
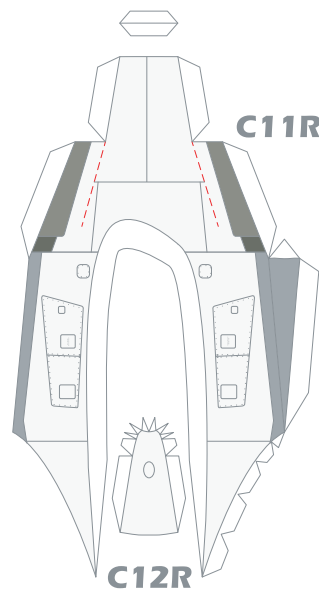

C3

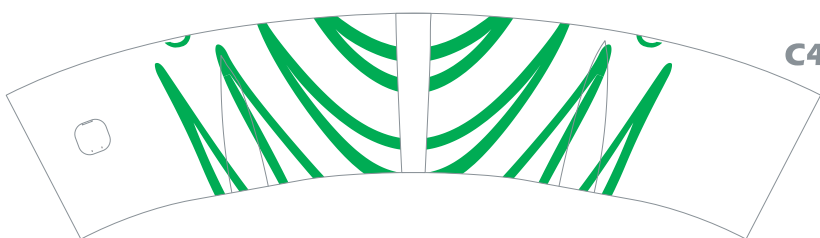

C4

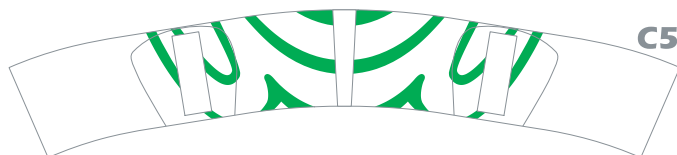

C5



C10L



C10R

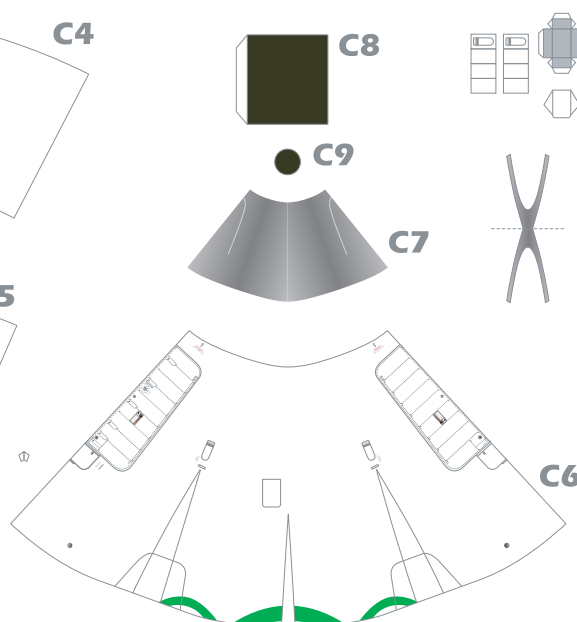

C8

C9

C7

C6

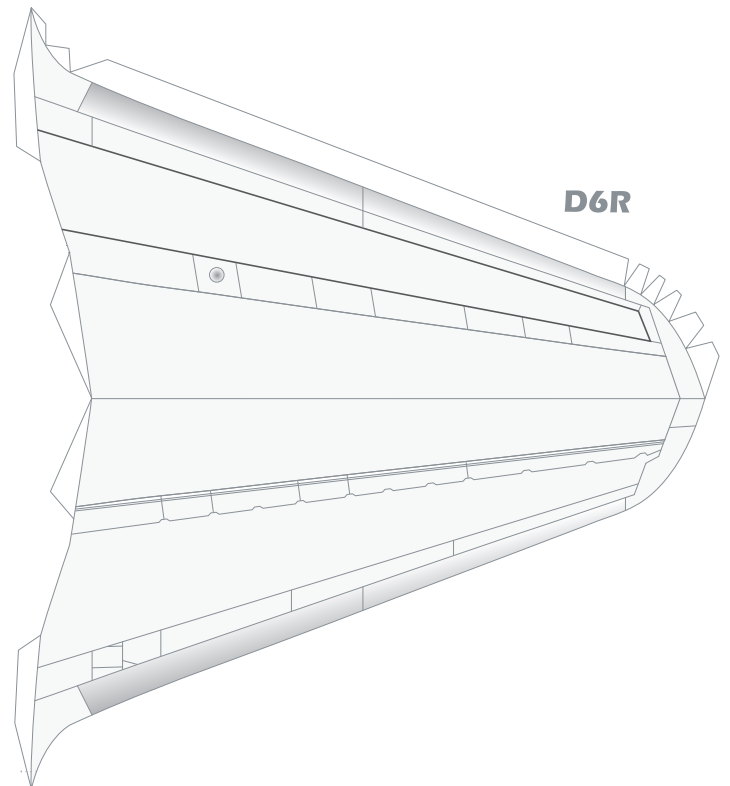
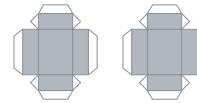
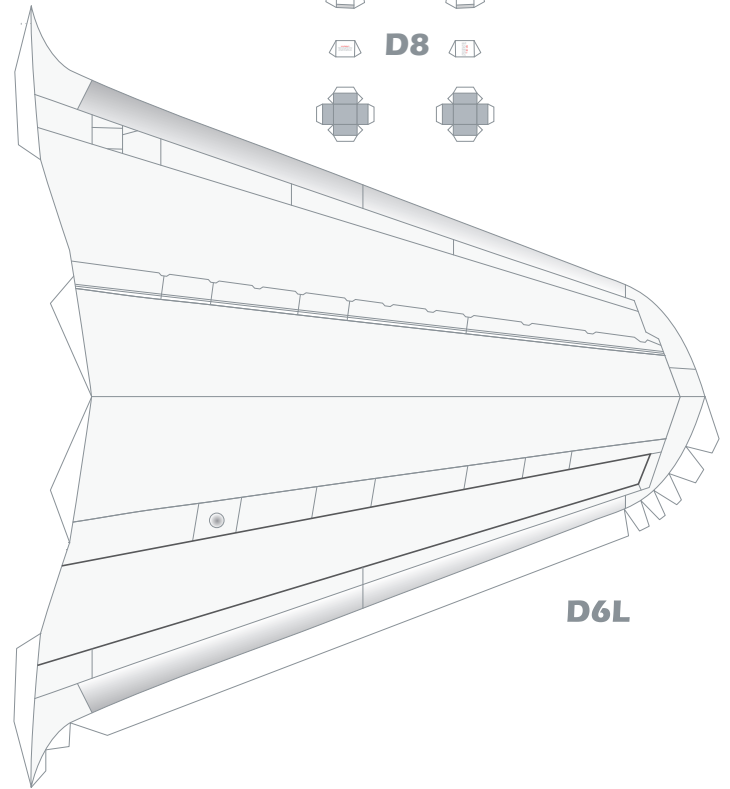
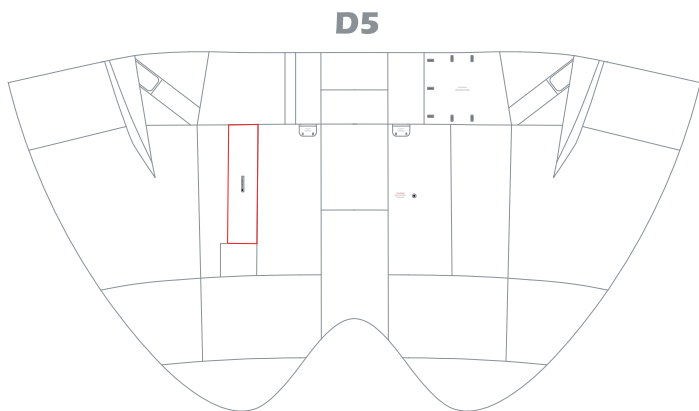
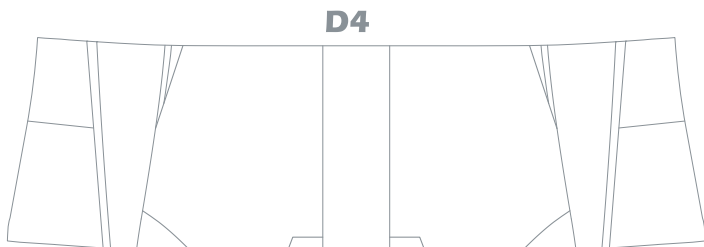
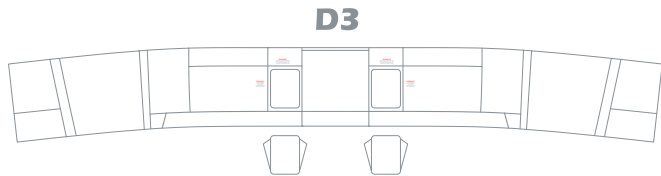
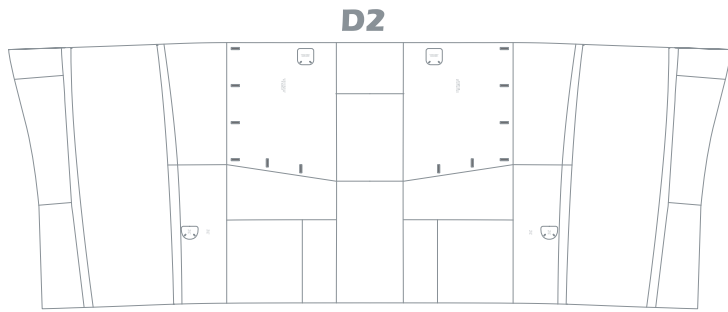
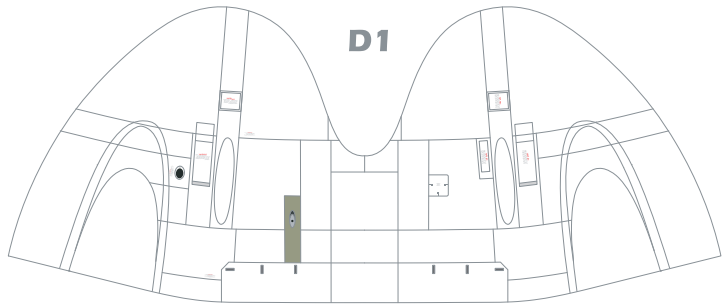

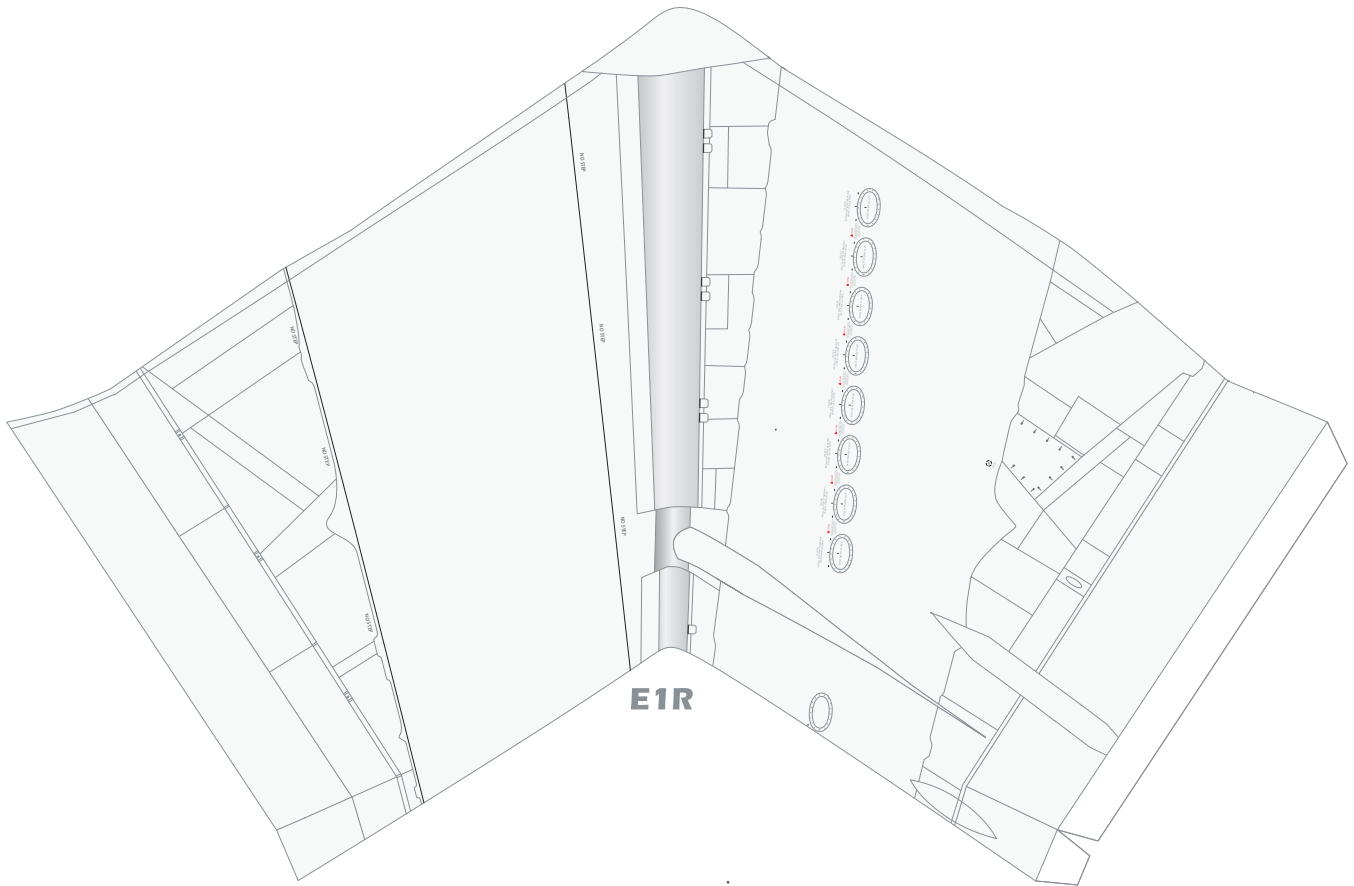
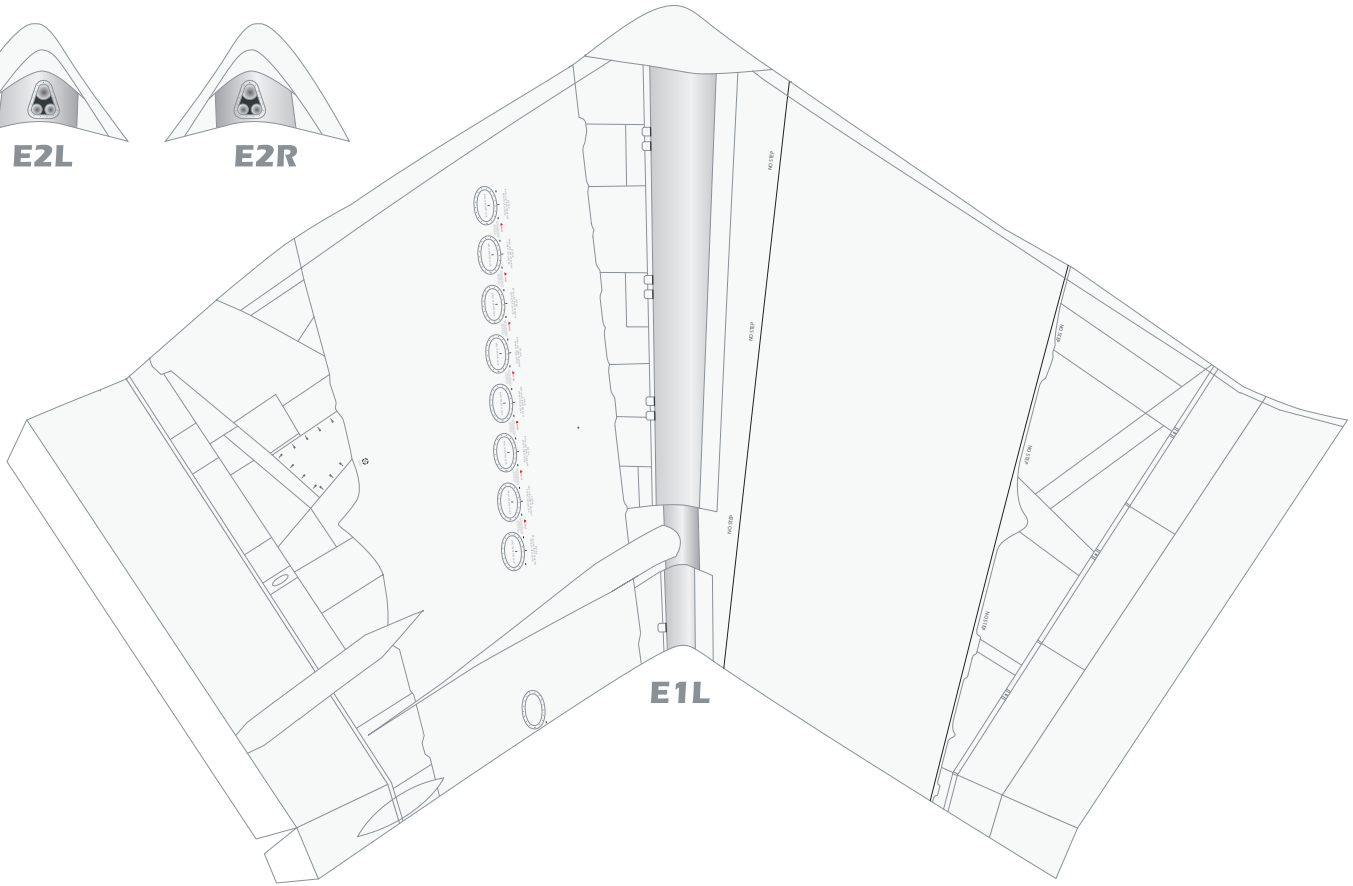

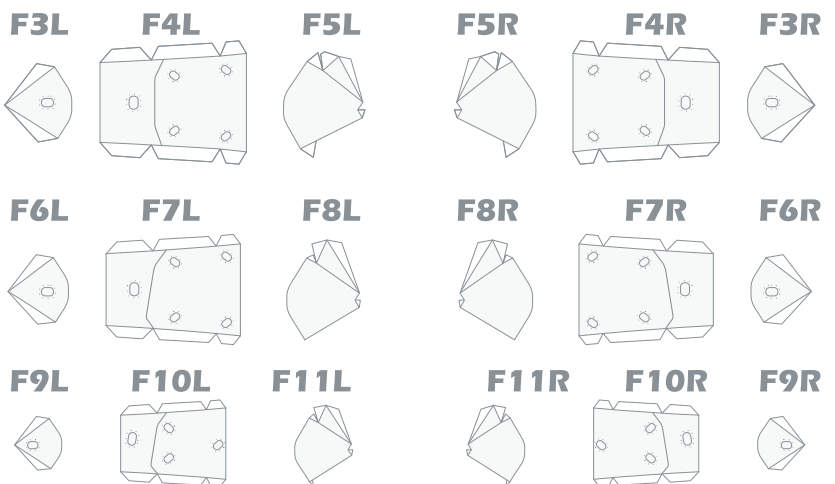
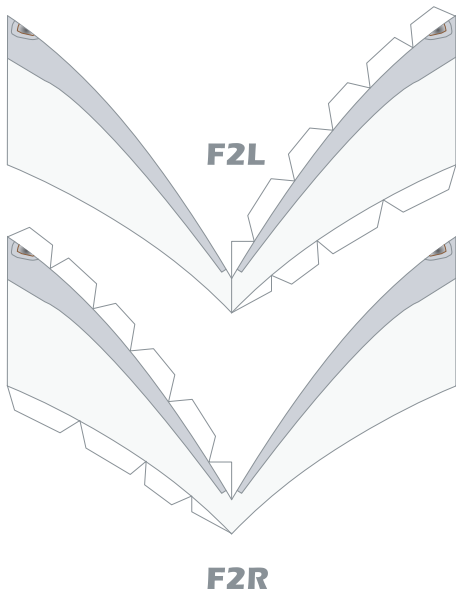
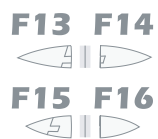
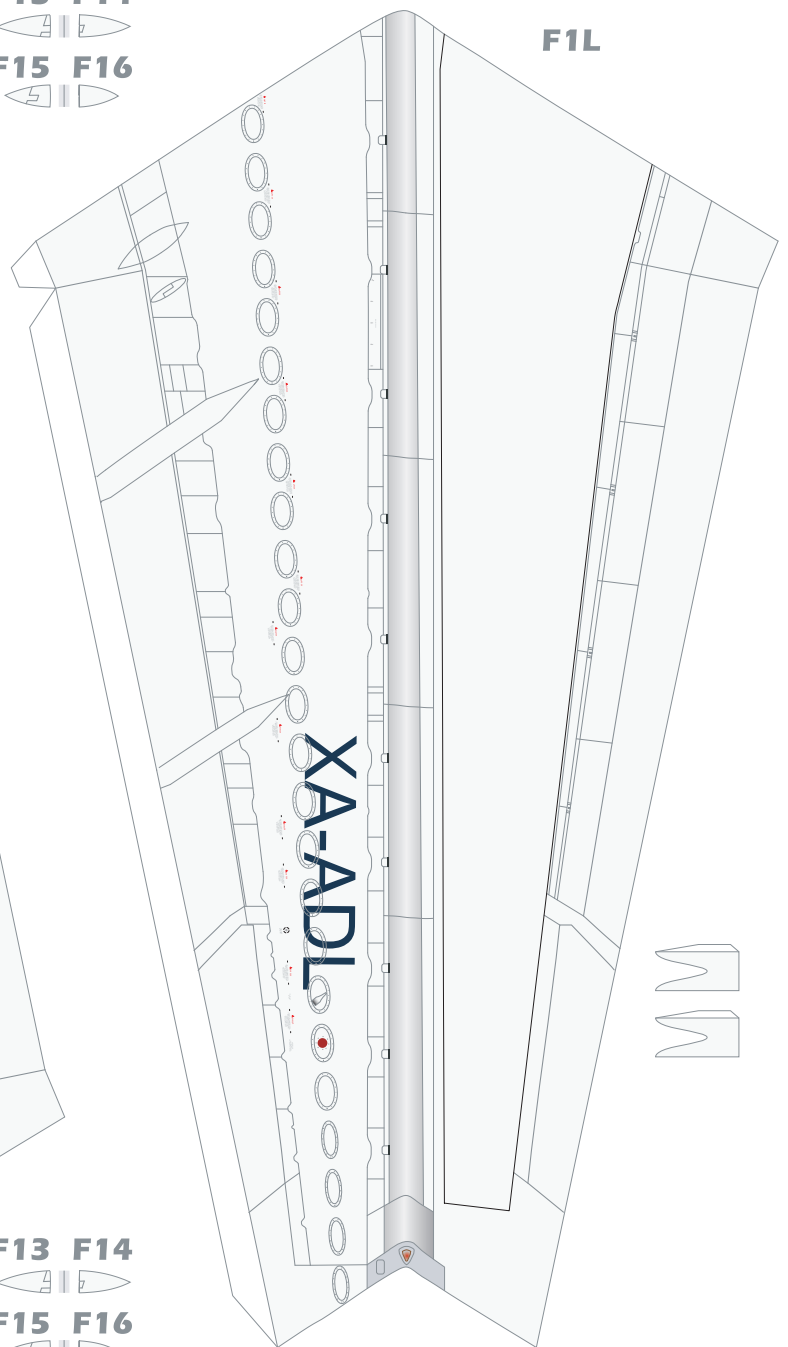
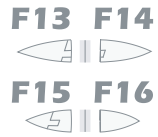
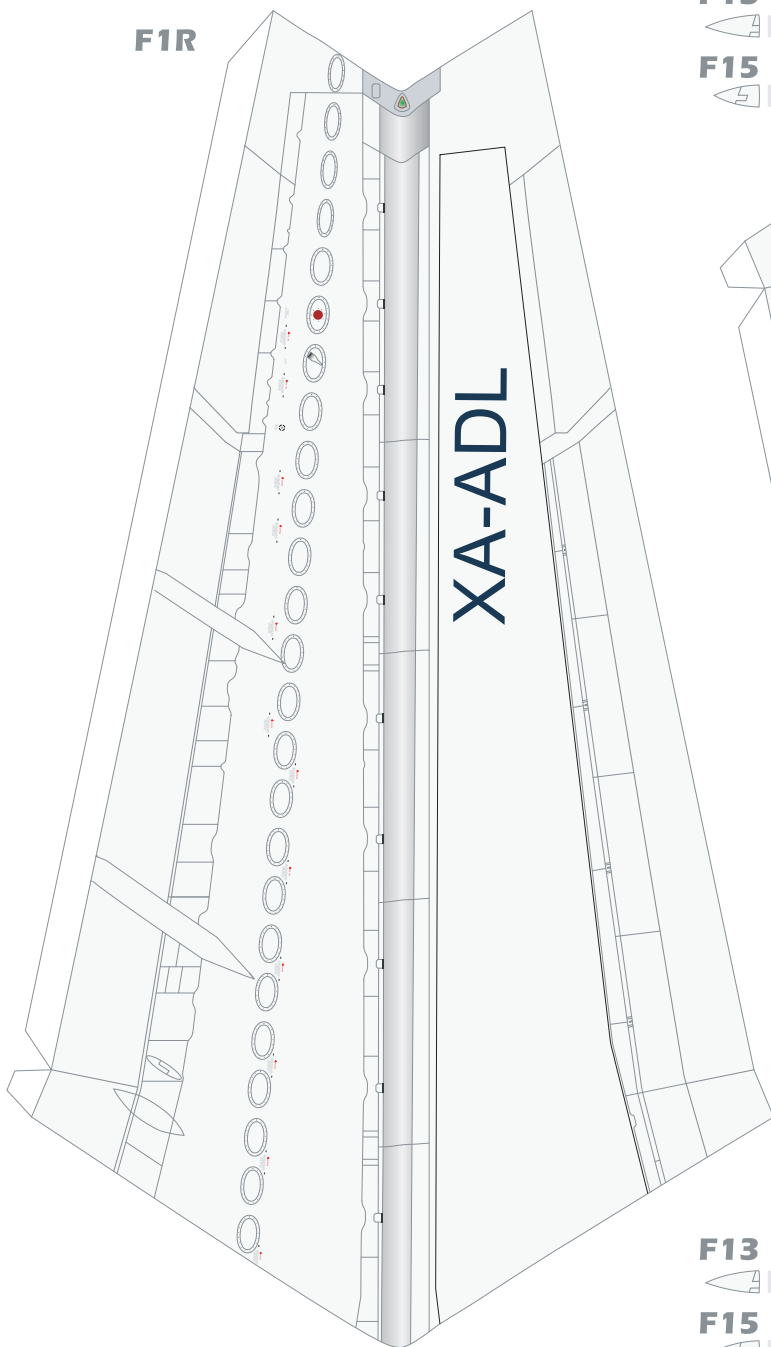

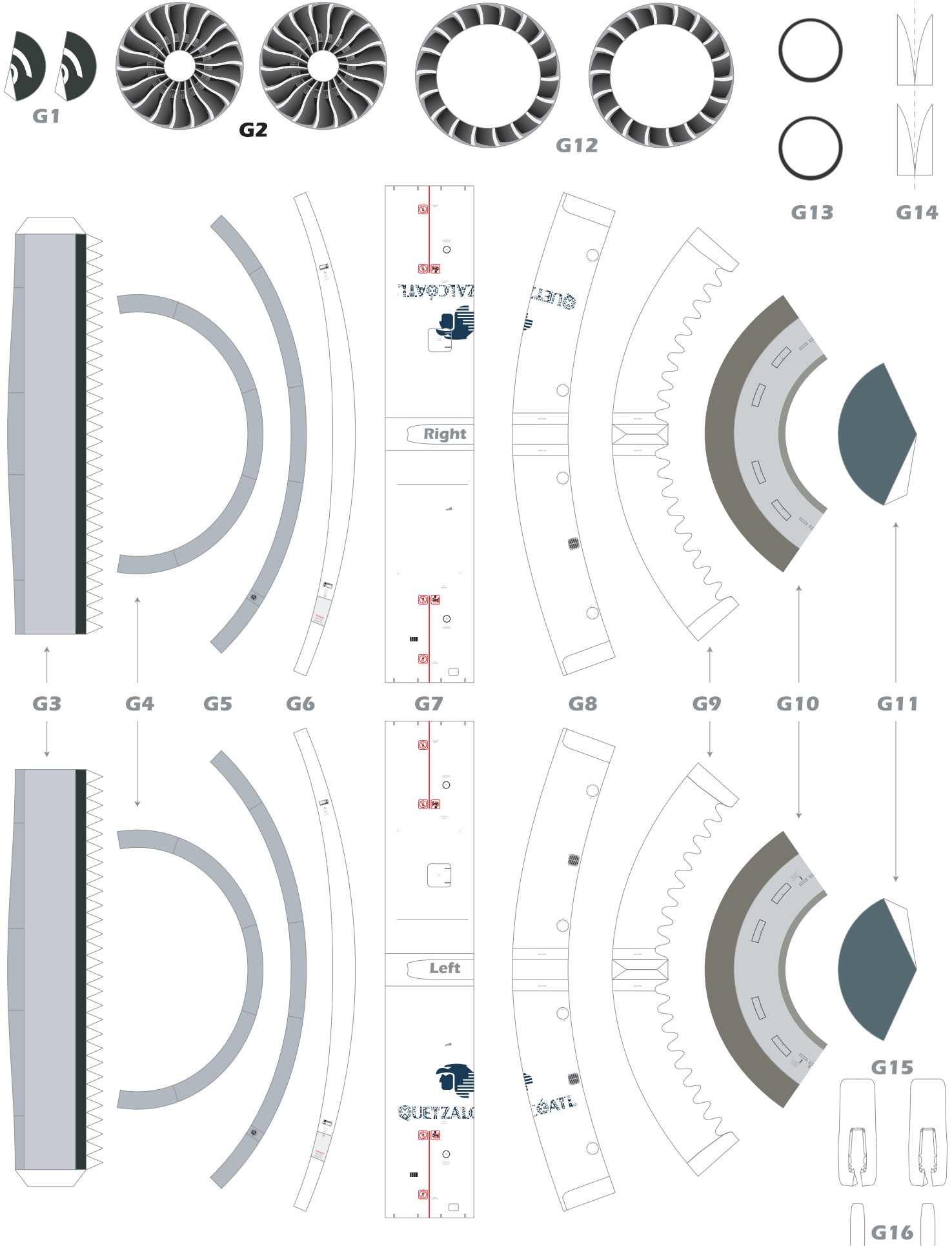

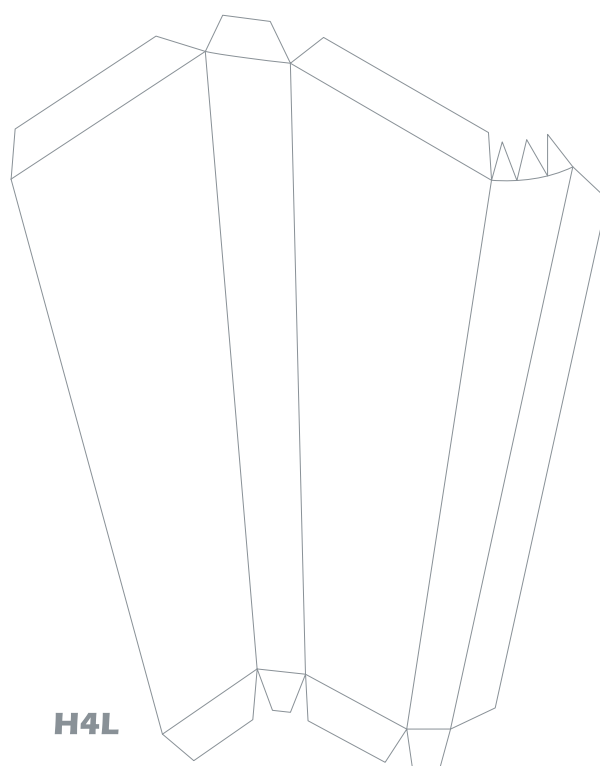
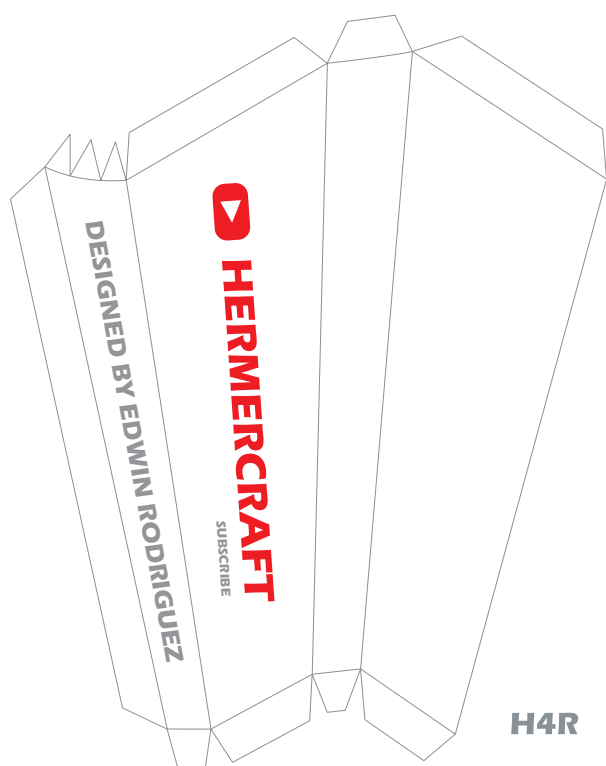
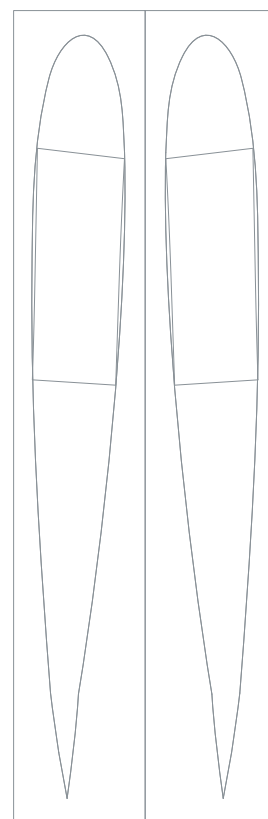
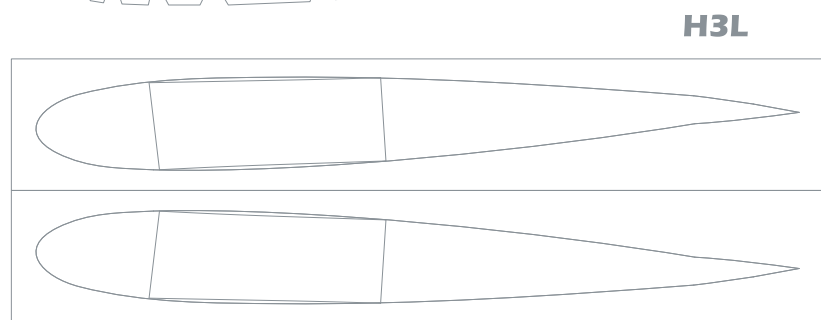
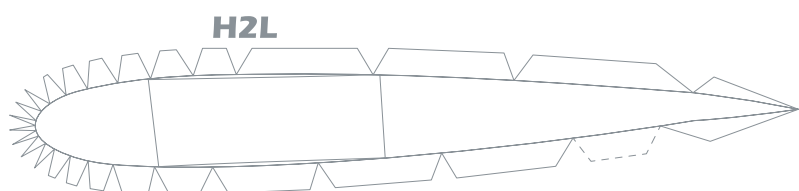
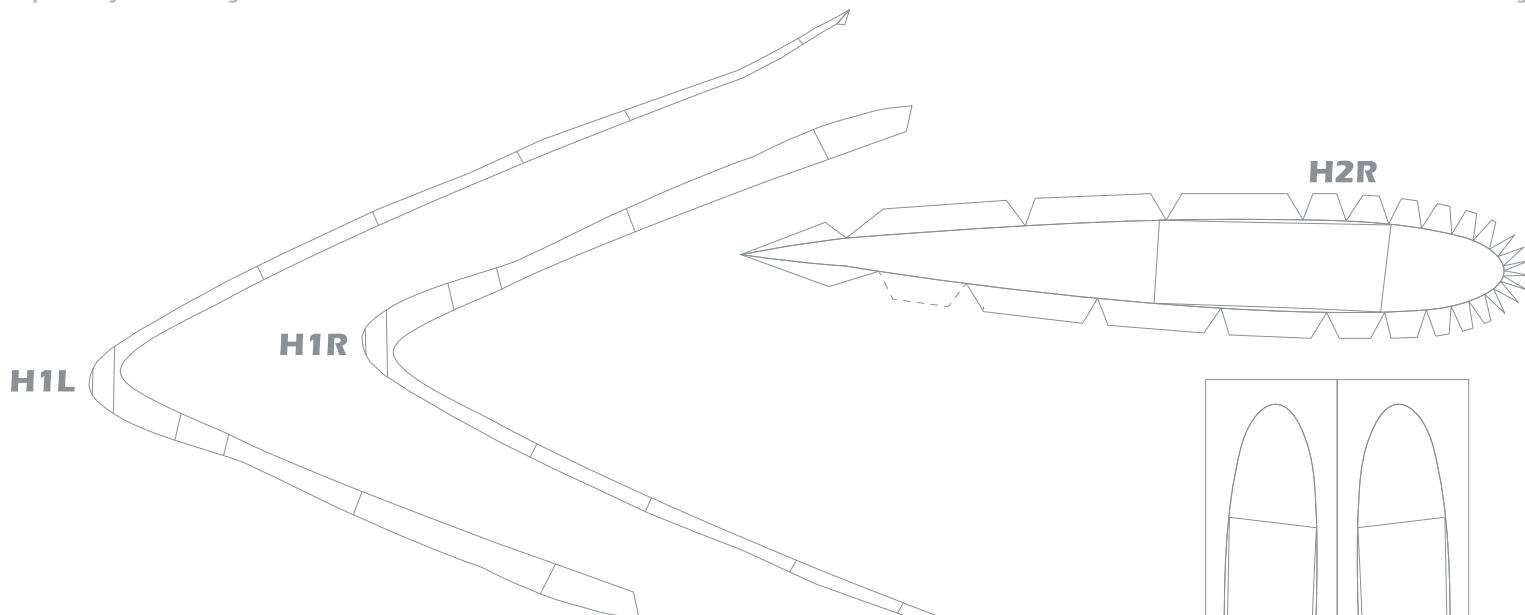

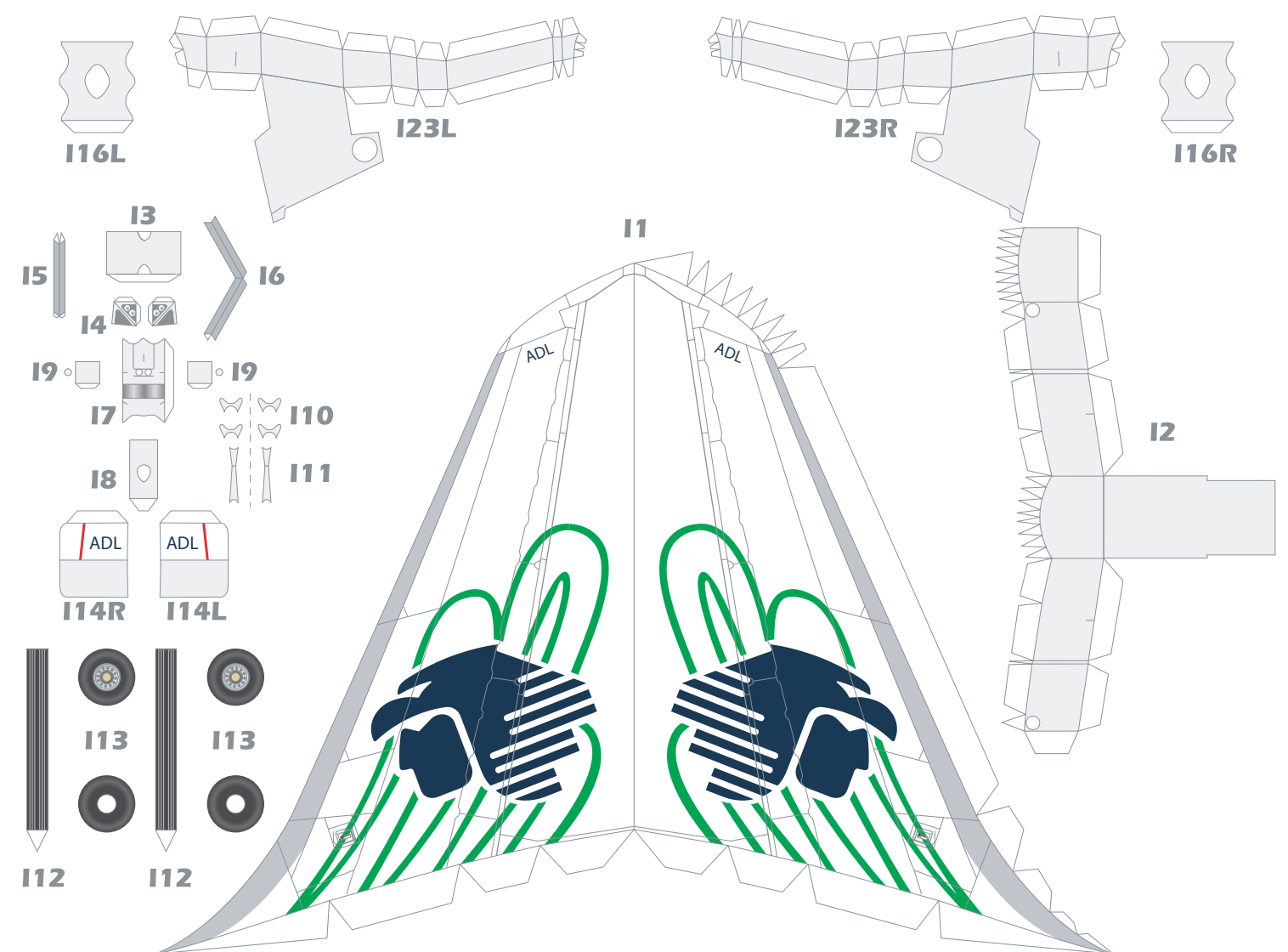
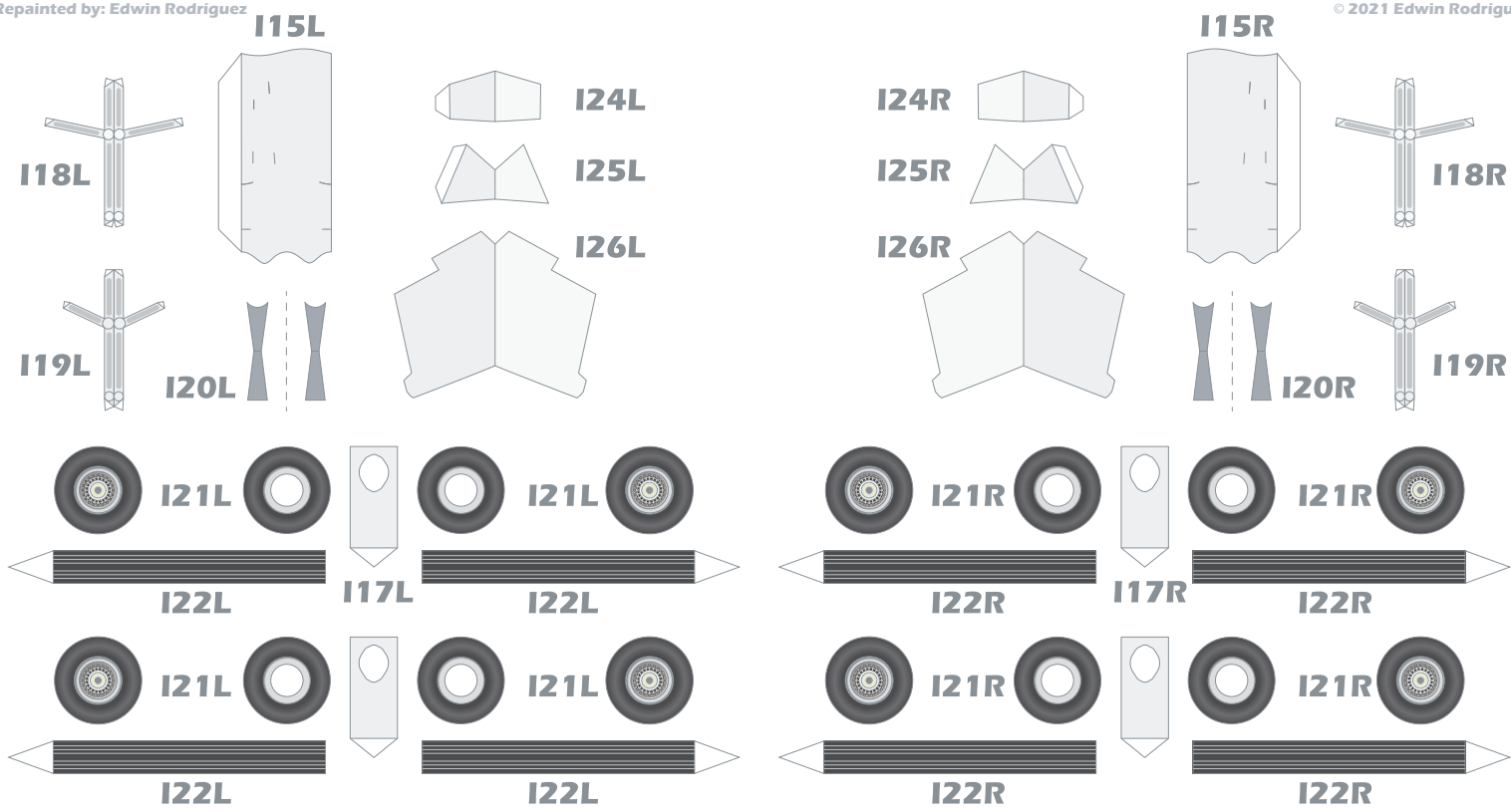

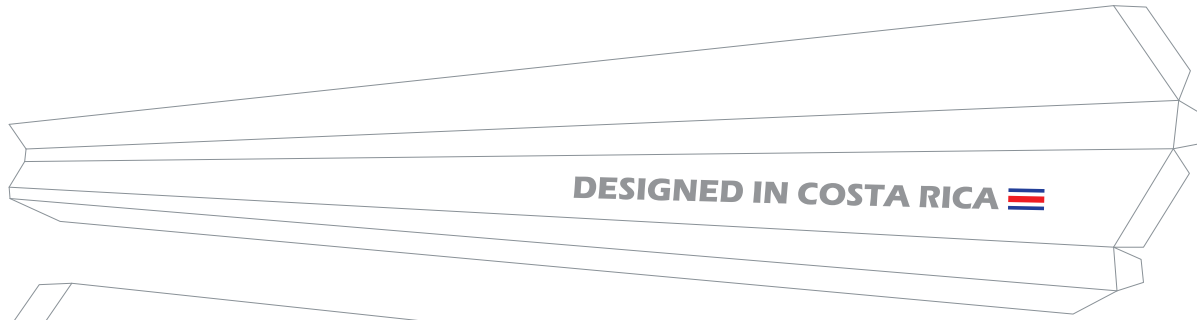

J1L



J1R

