

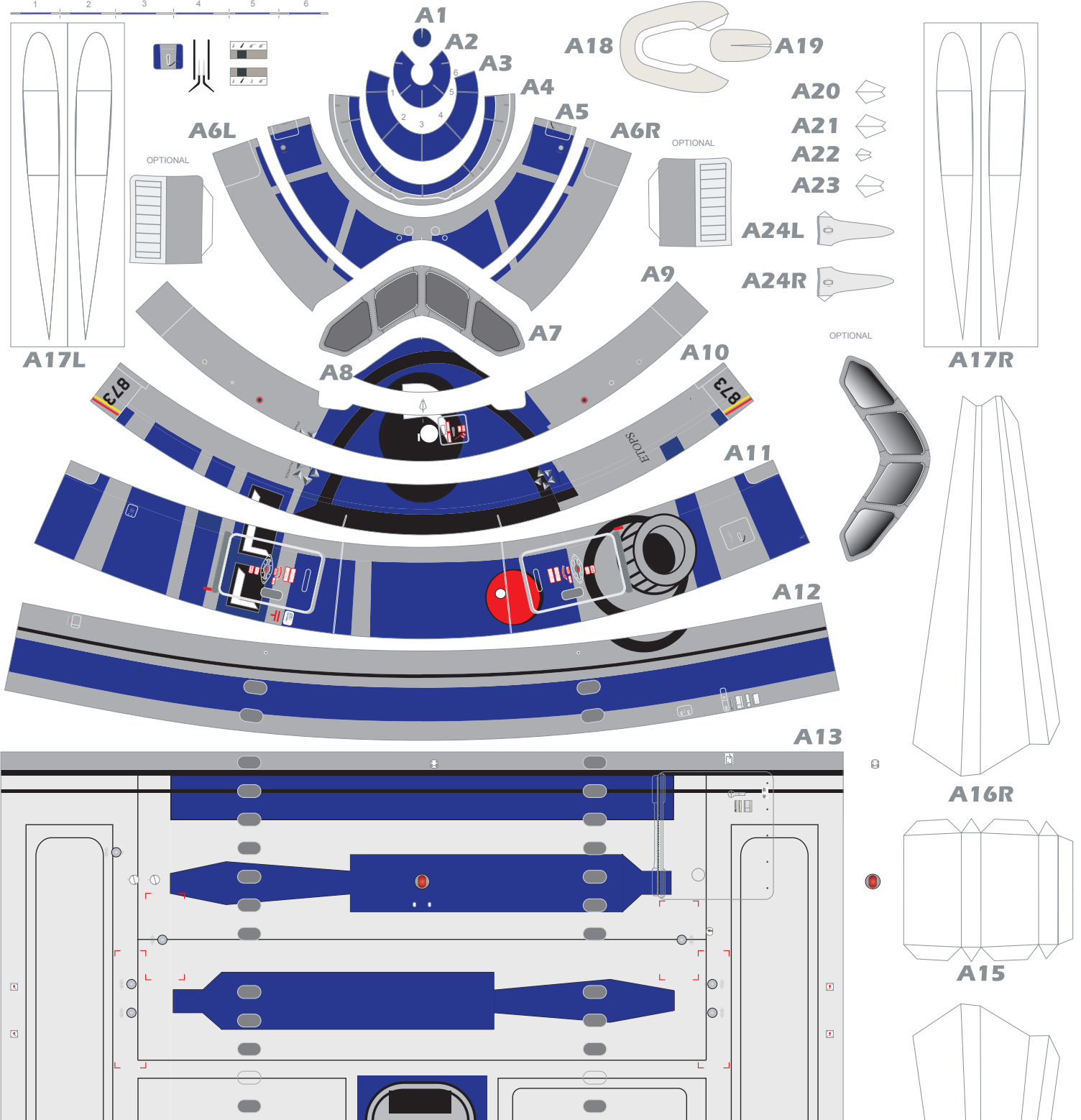

Repainted by: パズズズ & 高橋ジョシュア

© 2021 Edwin Rodriguez



Blank space for 787-10 variant

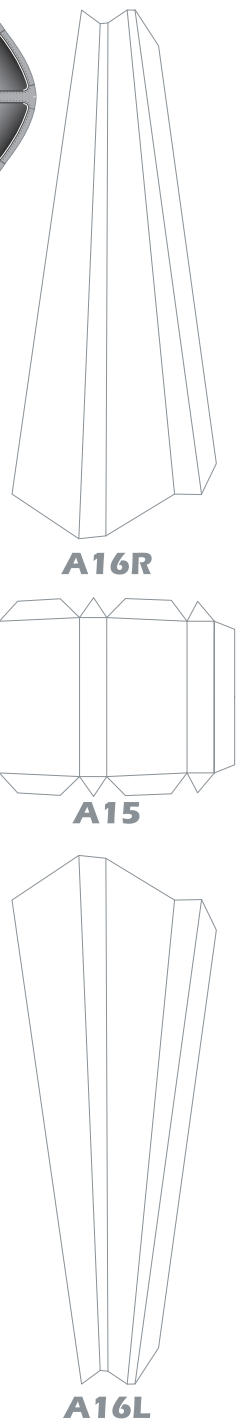
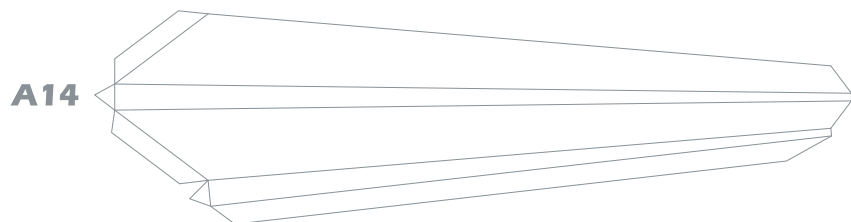

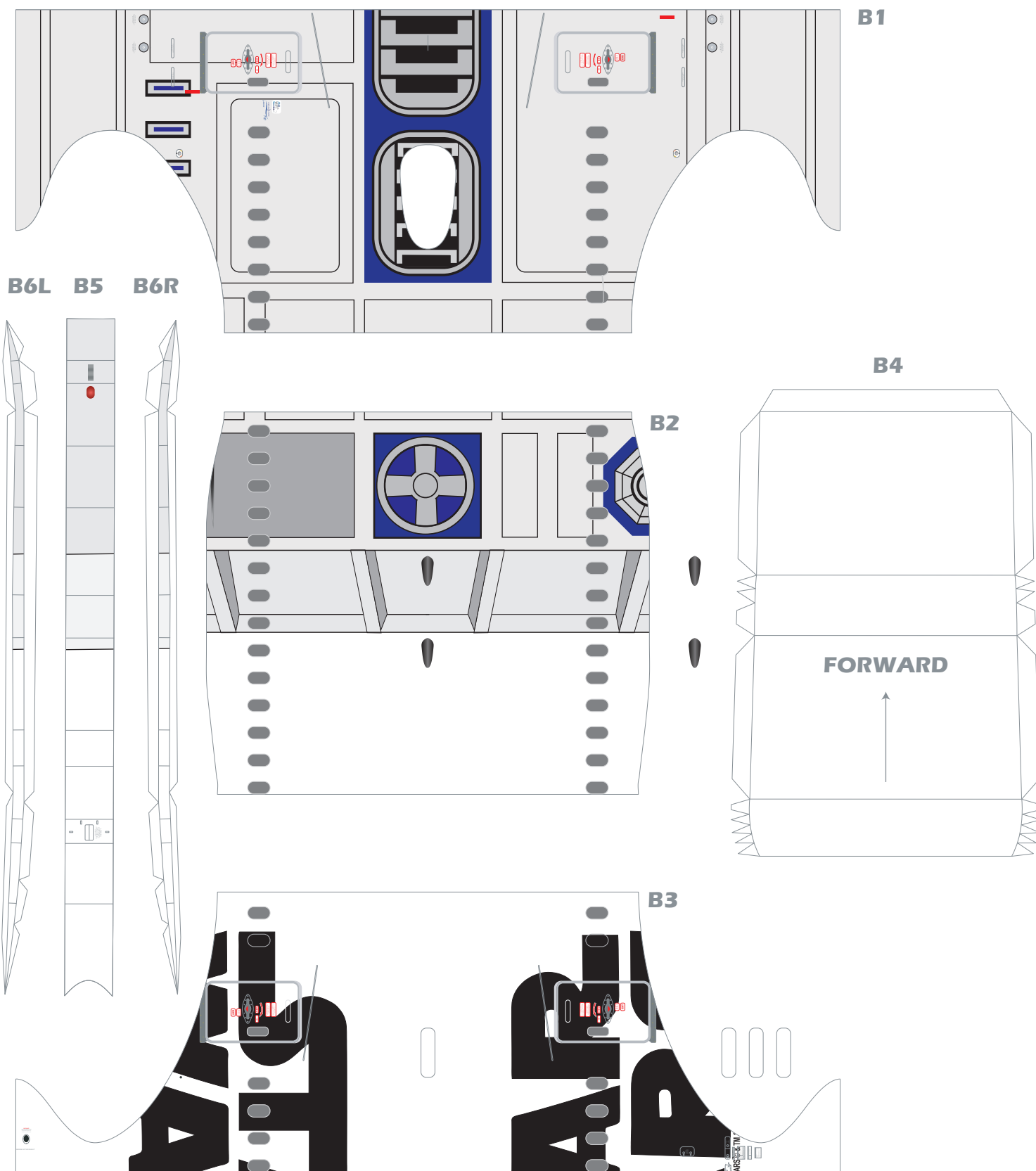

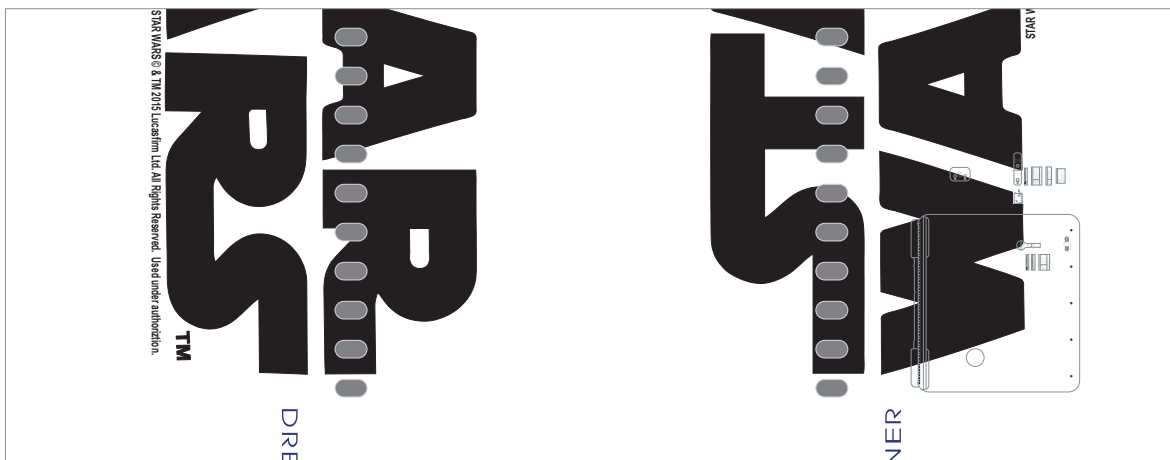

Blank space for 787-10 variant

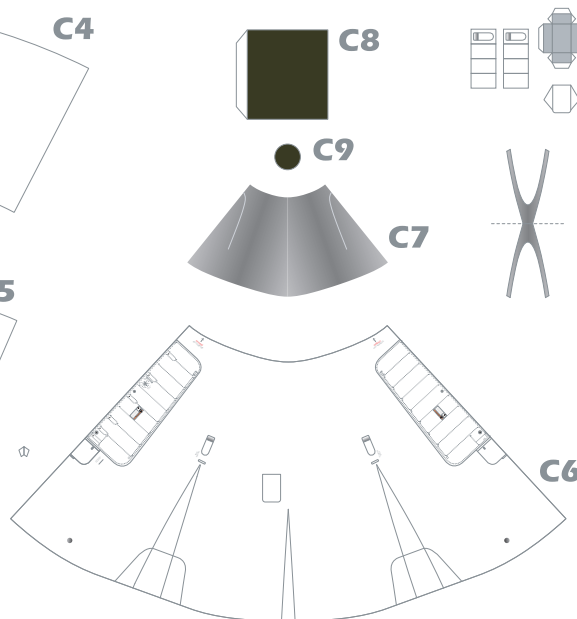
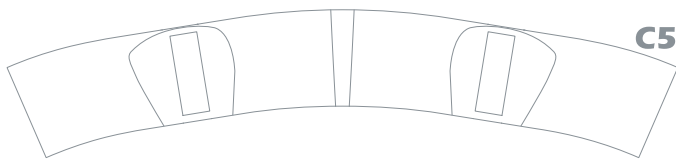
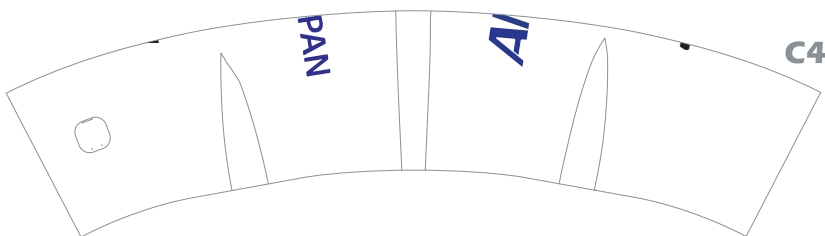
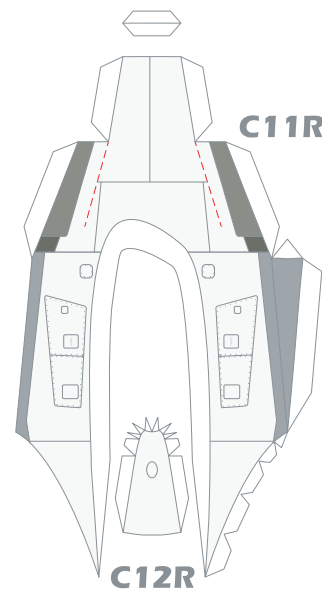
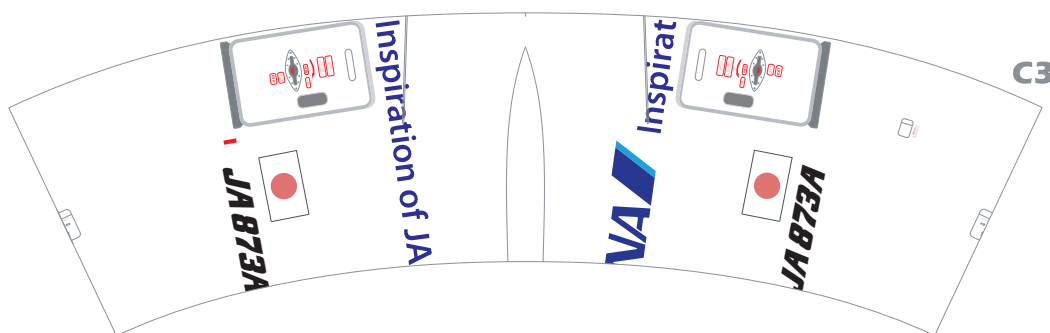
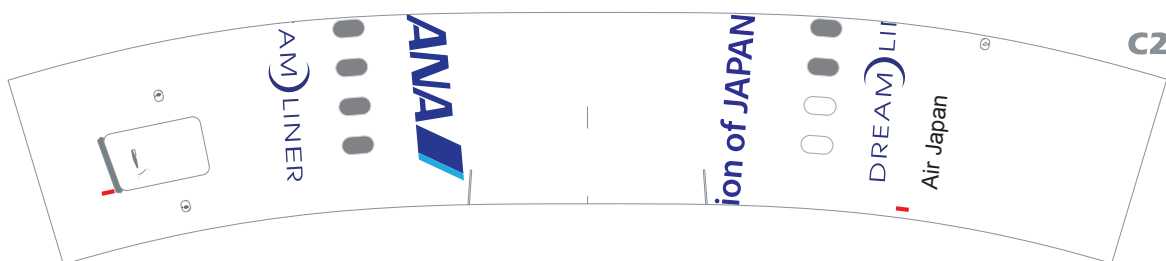
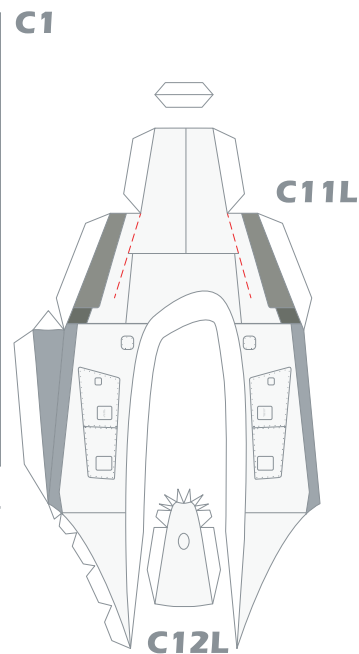

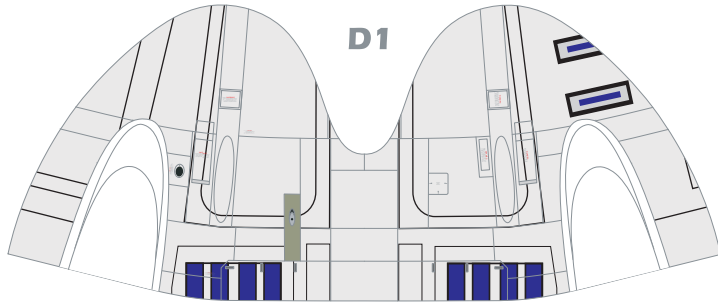

D1

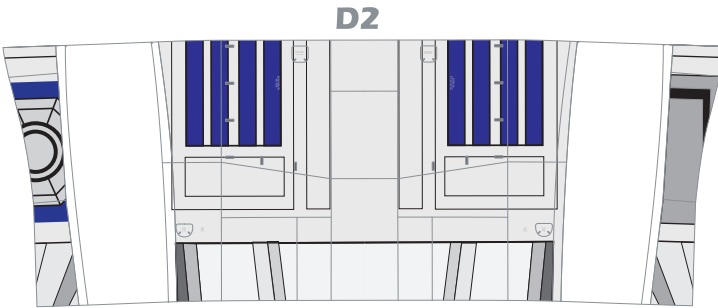

D2

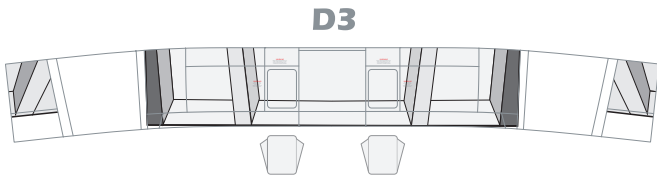

D3

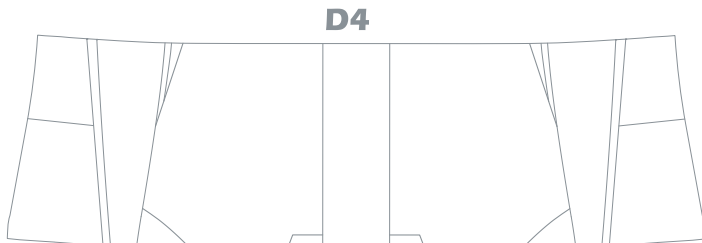

D4

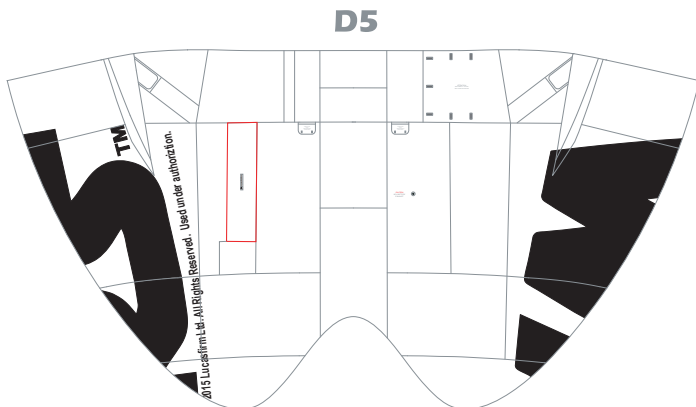

D5



D7



D8

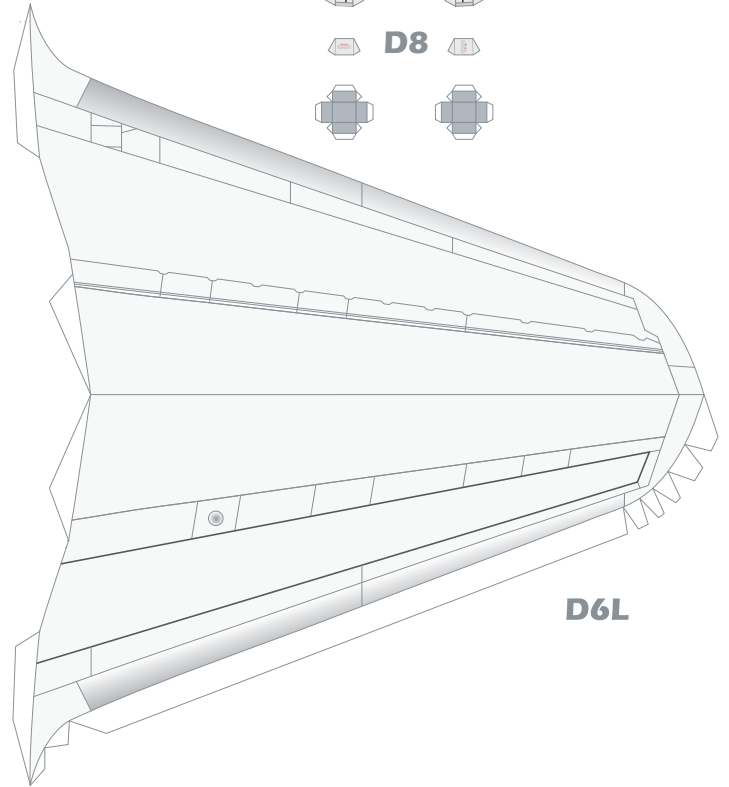

D6L

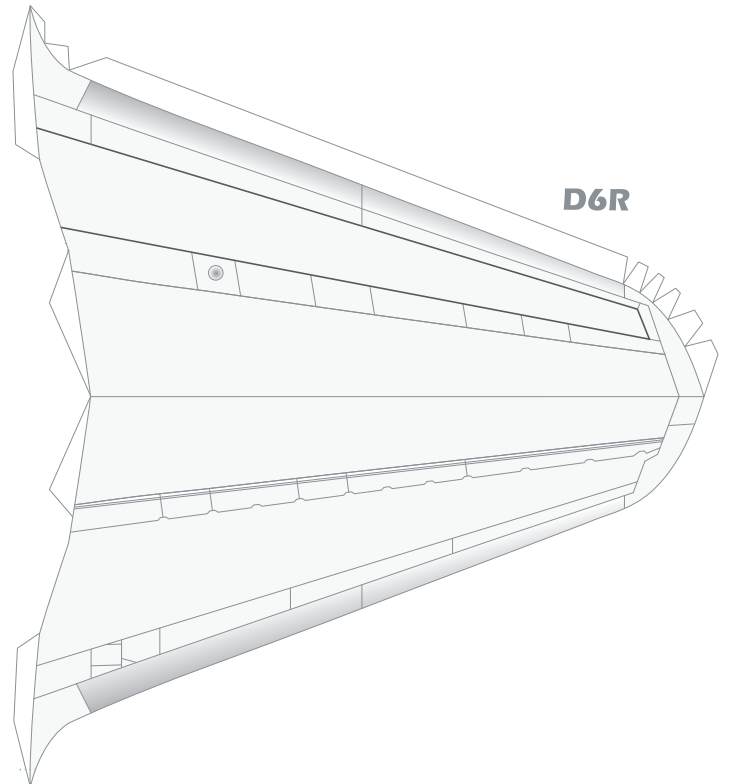

D6R



Repainted by: パズーズ & 高橋ジョシュア

© 2021 Edwin Rodriguez



E2L



E2R

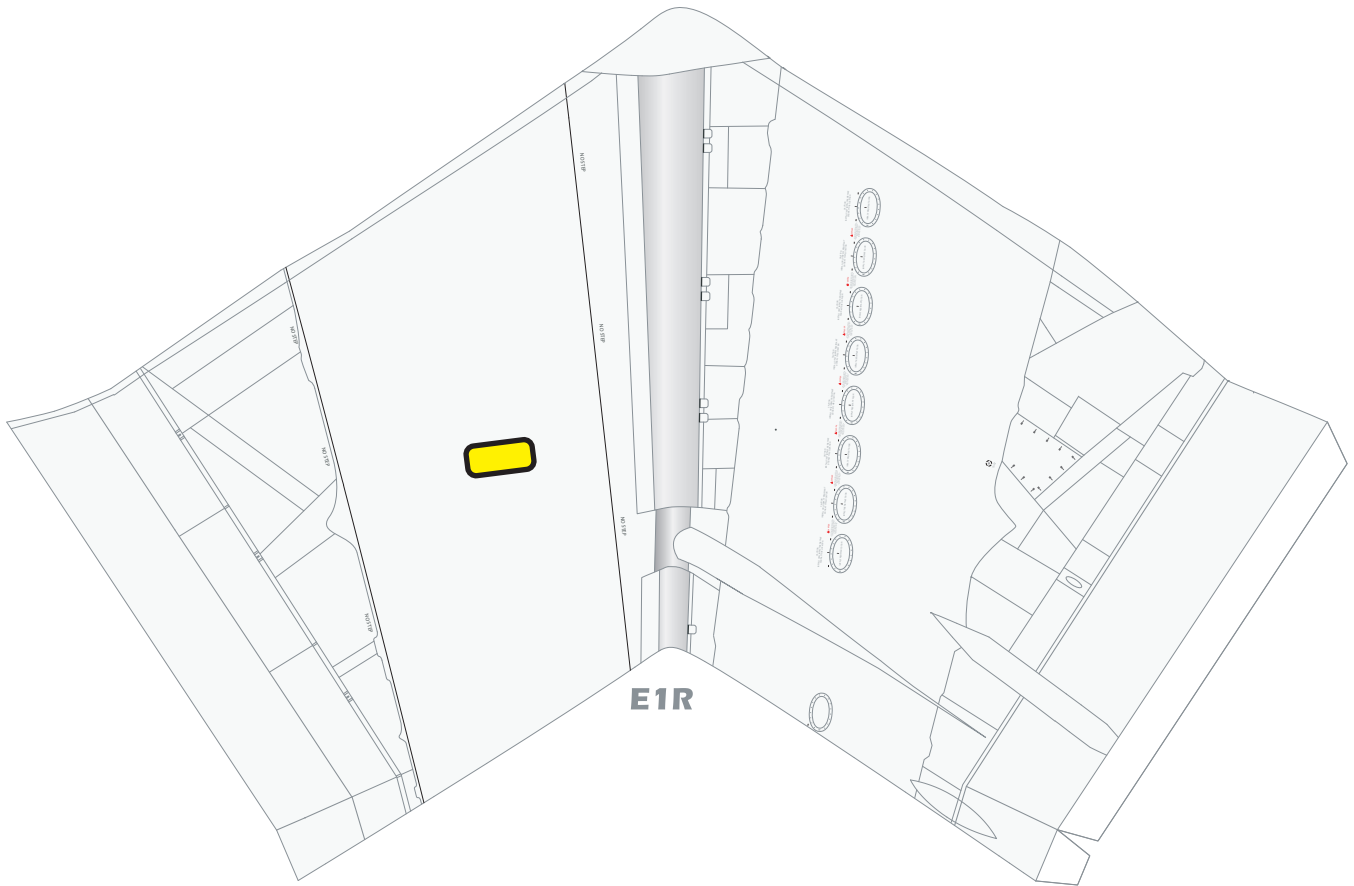
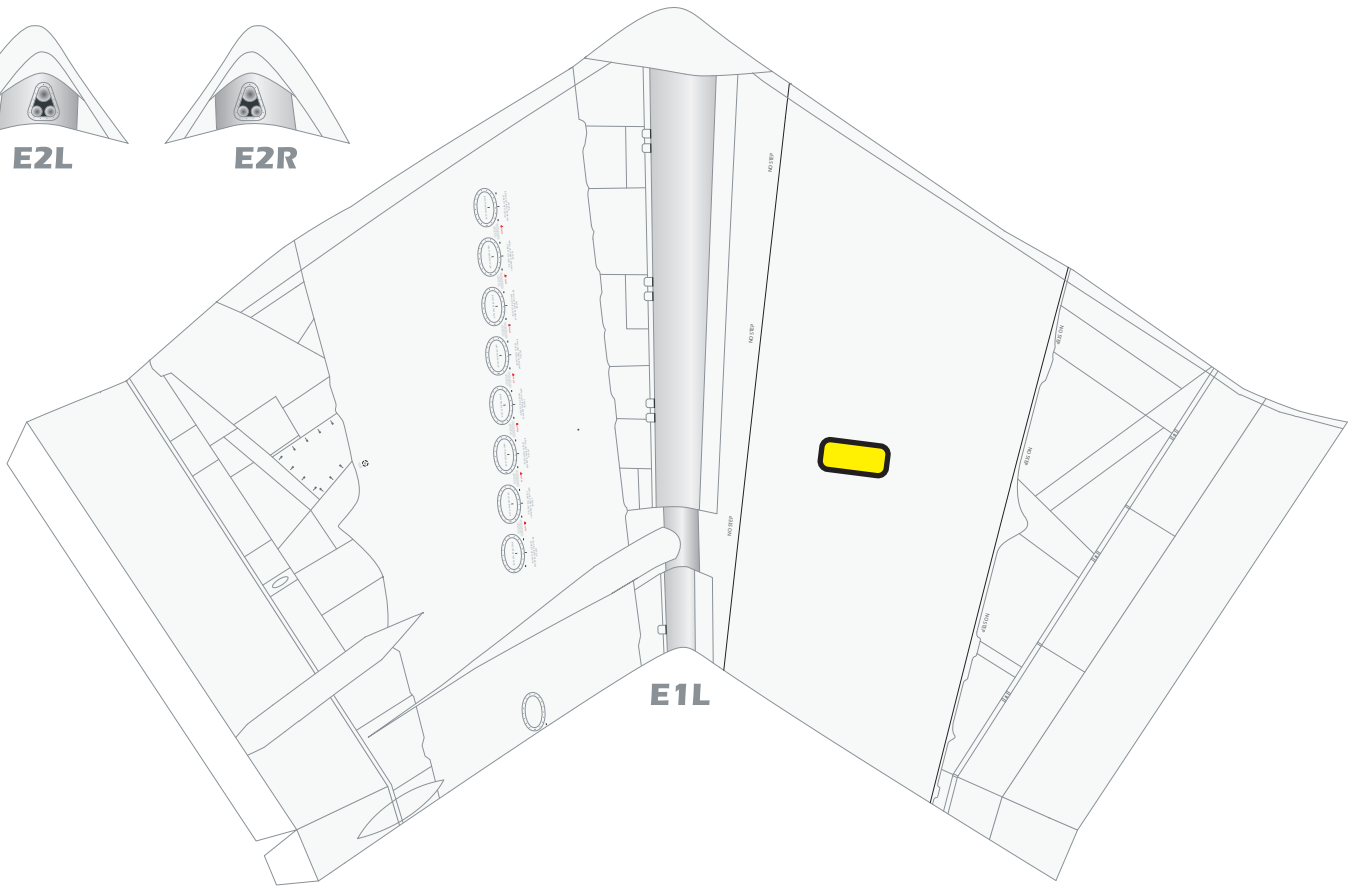

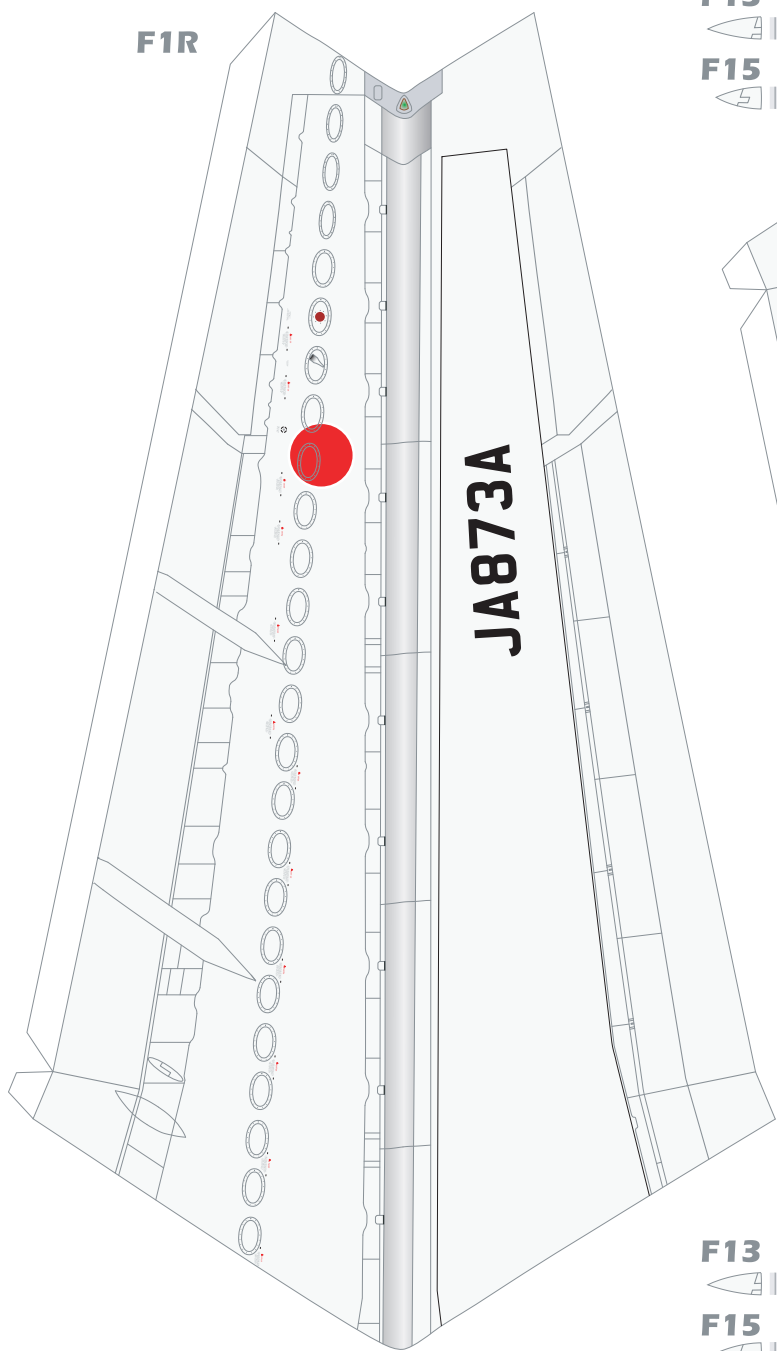

F13 F14



F15 F16

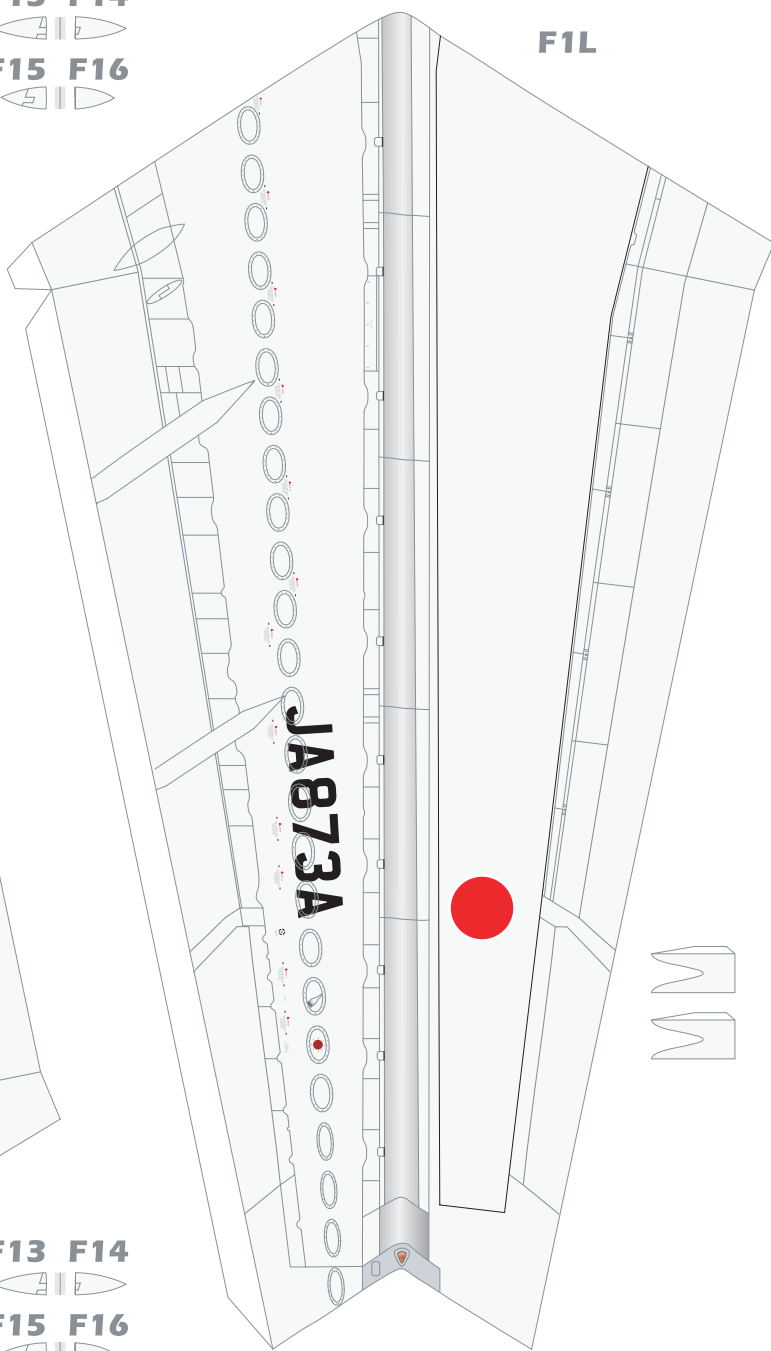

F13 F14



F15 F16

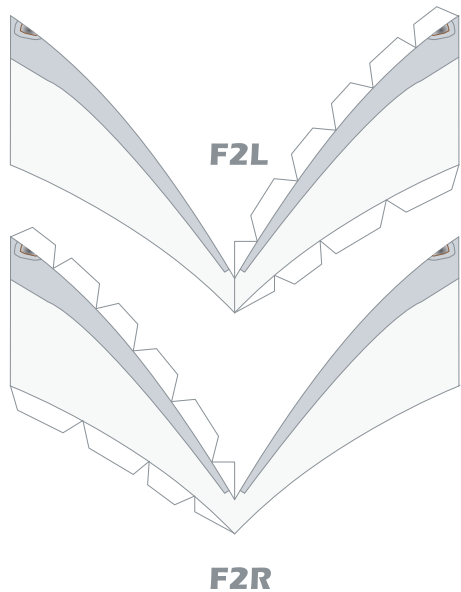

F3L



F4L

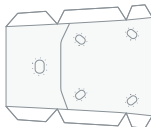

F5L



F5R



F4R

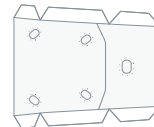

F3R



F6L



F7L

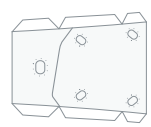

F8L



F8R



F7R

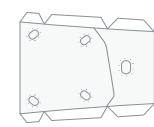

F6R



F9L



F10L



F11L



F11R



F10R



F9R





Repainted by: パズーズズ & 高橋ジョシュア

ENGINES: ROLLS-ROYCE TRENT 1000

© 2021 Edwin Rodriguez

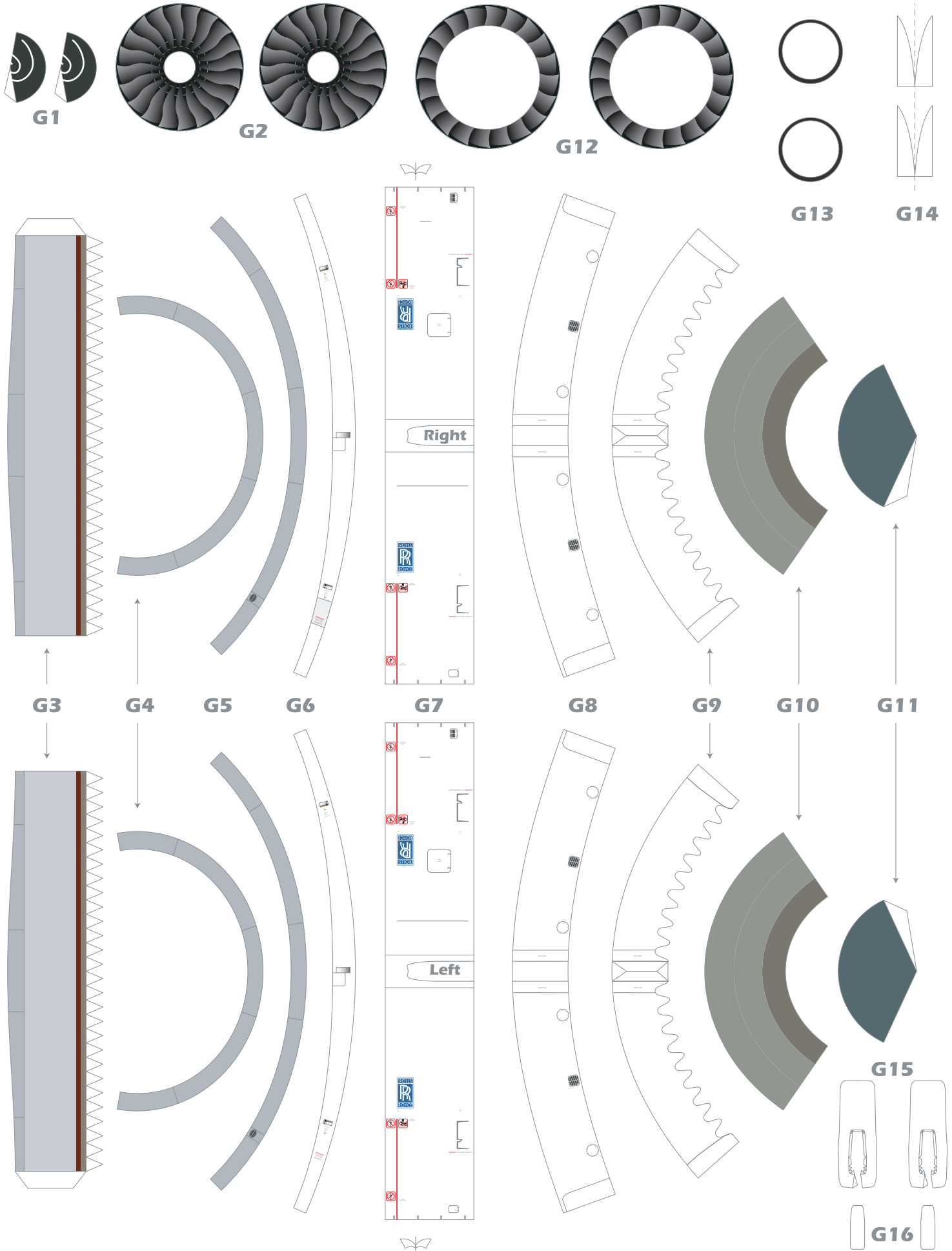

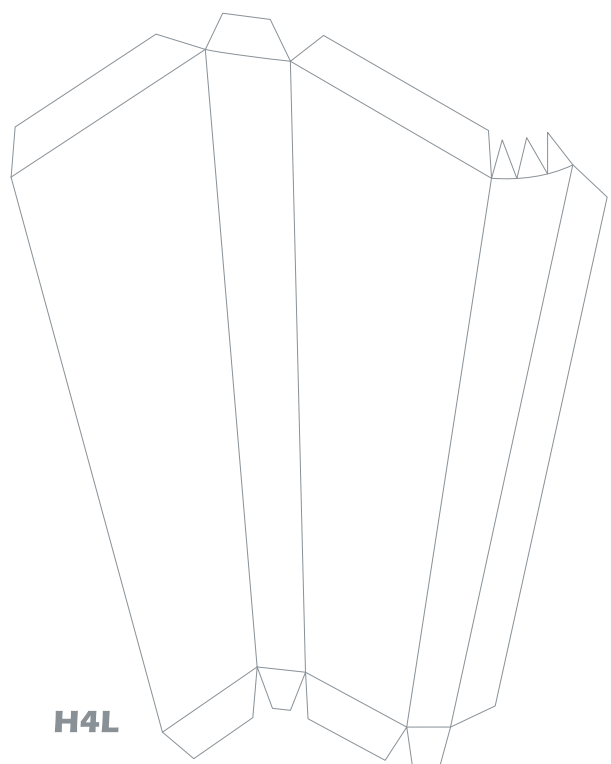
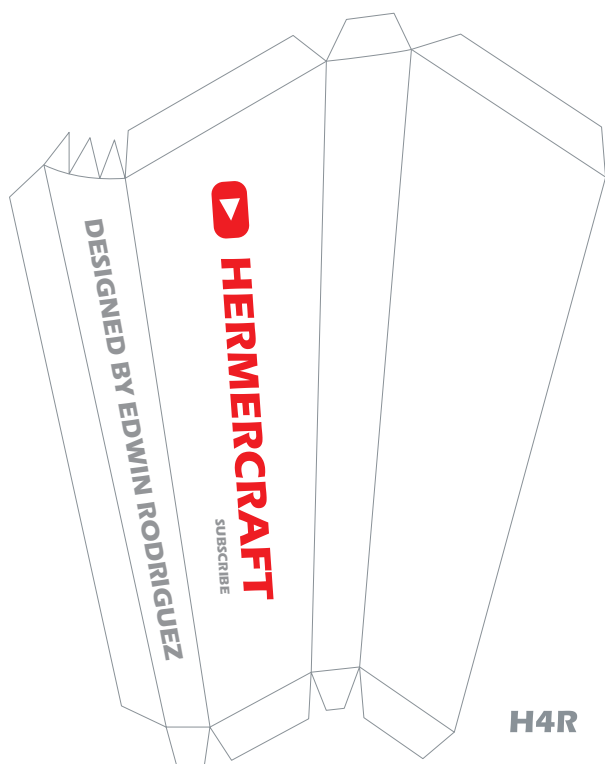
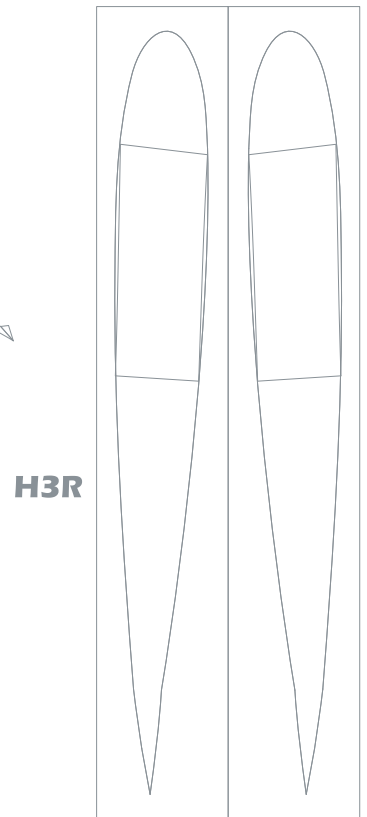
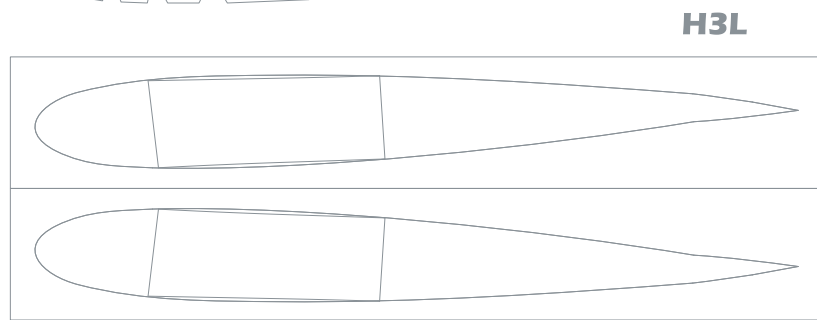
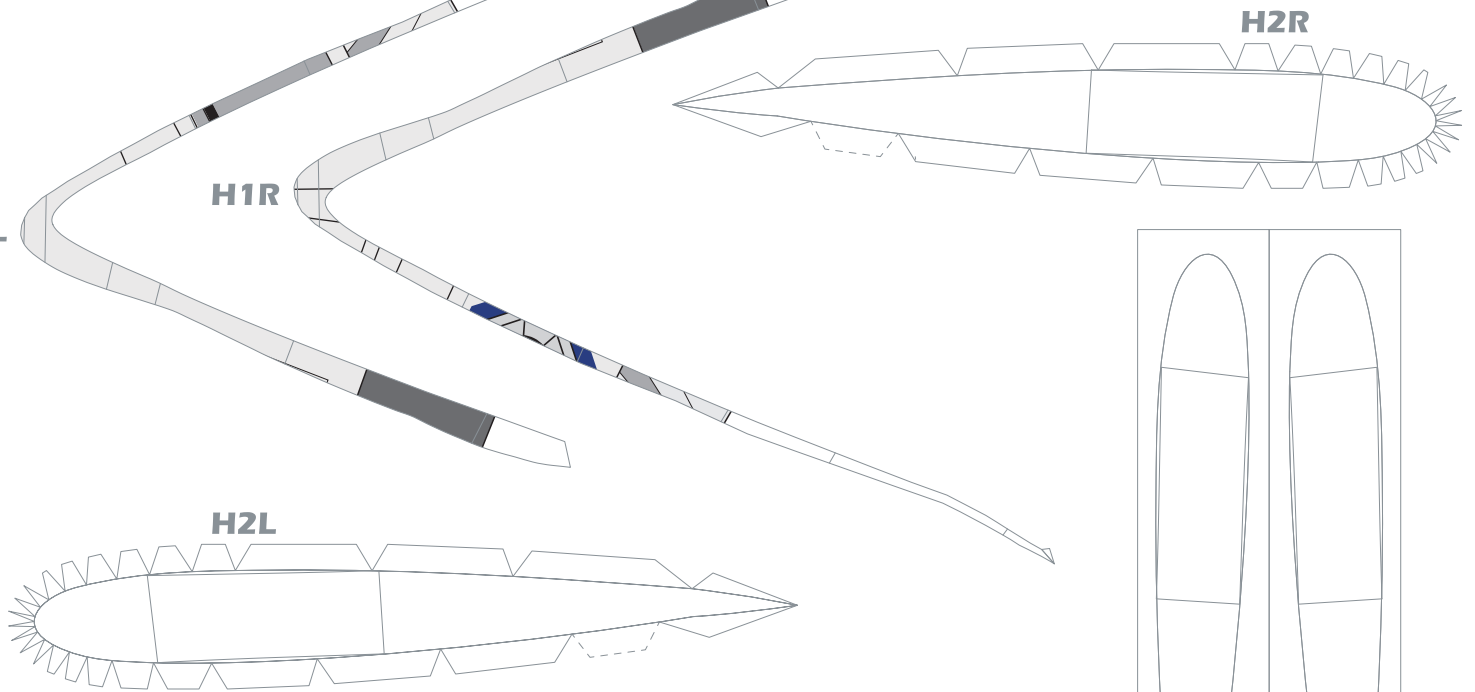
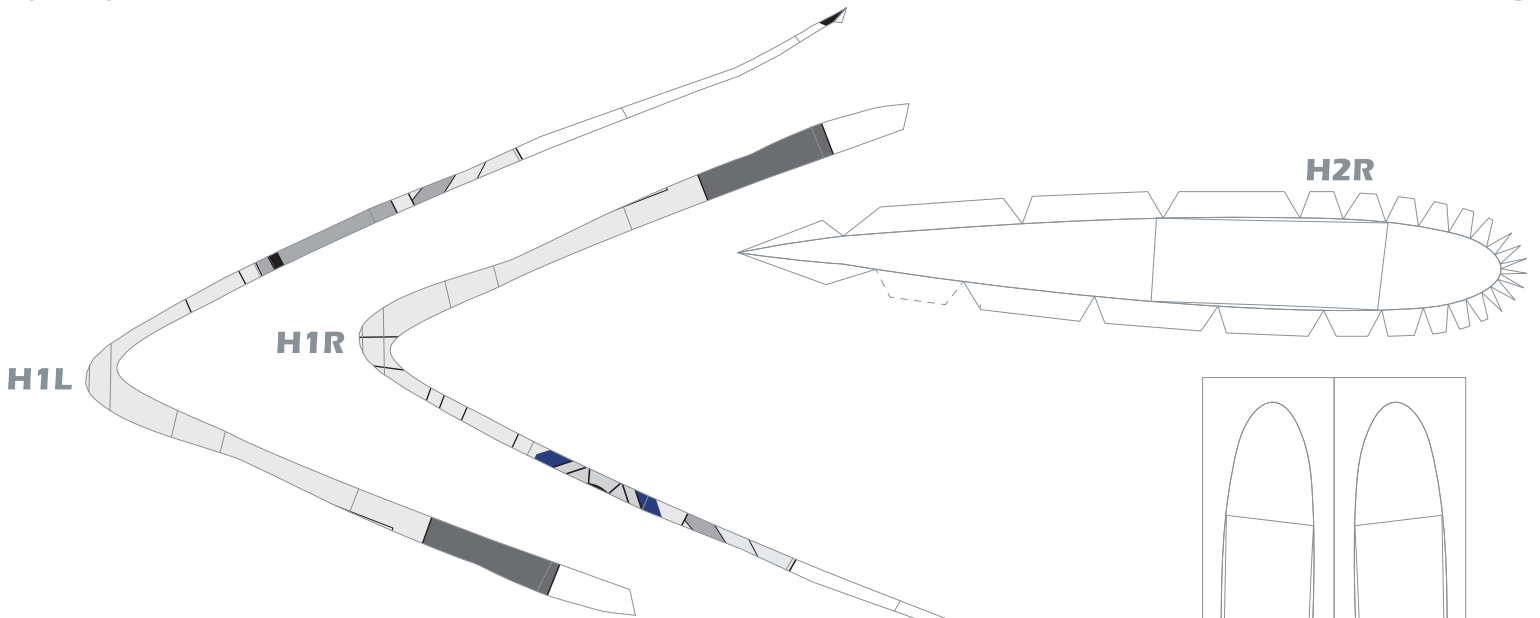



Repainted by: パズーズ & 高橋ジョシュア

© 2021 Edwin Rodriguez

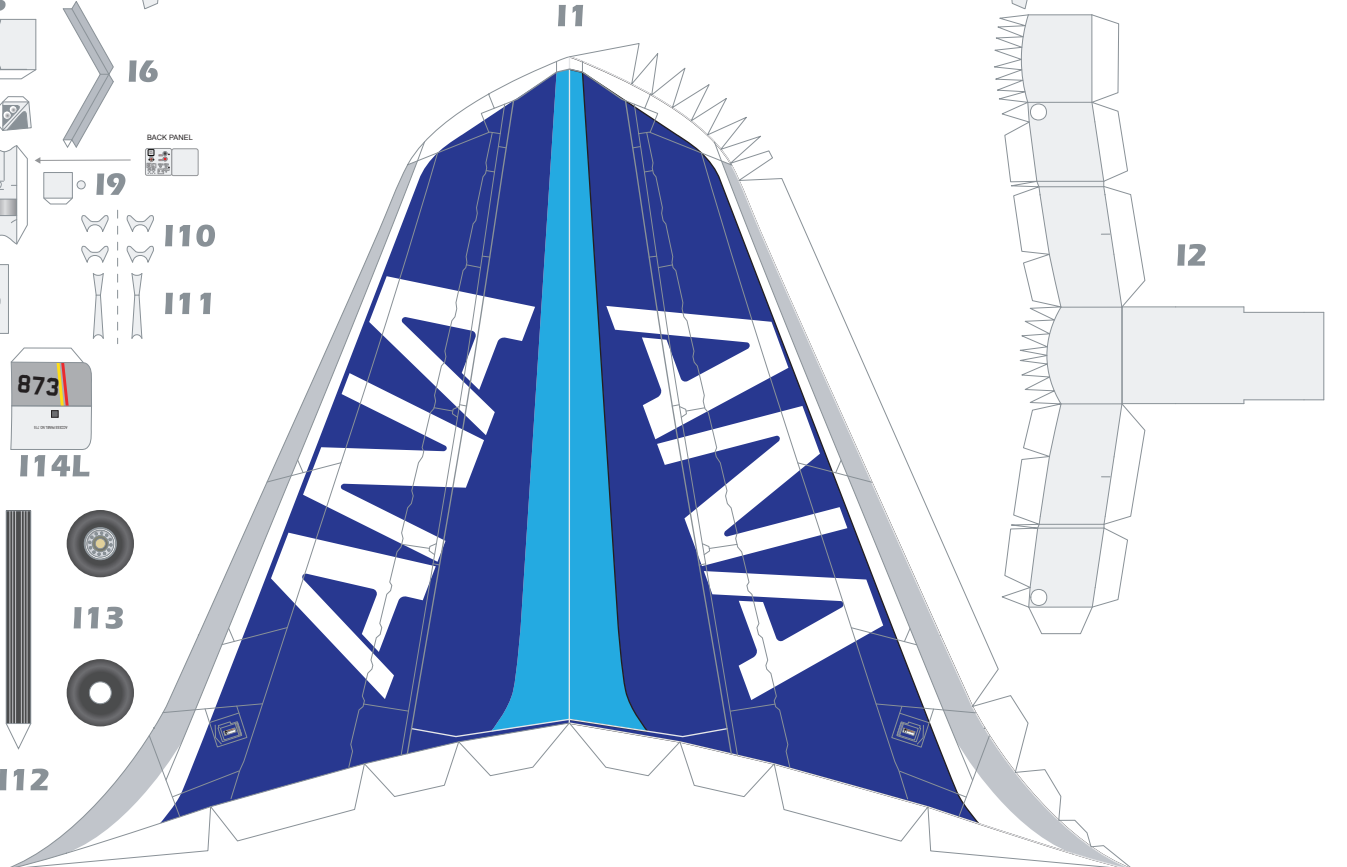
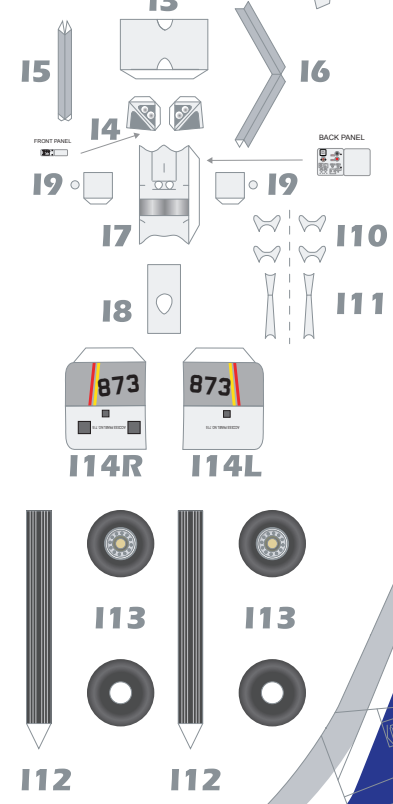
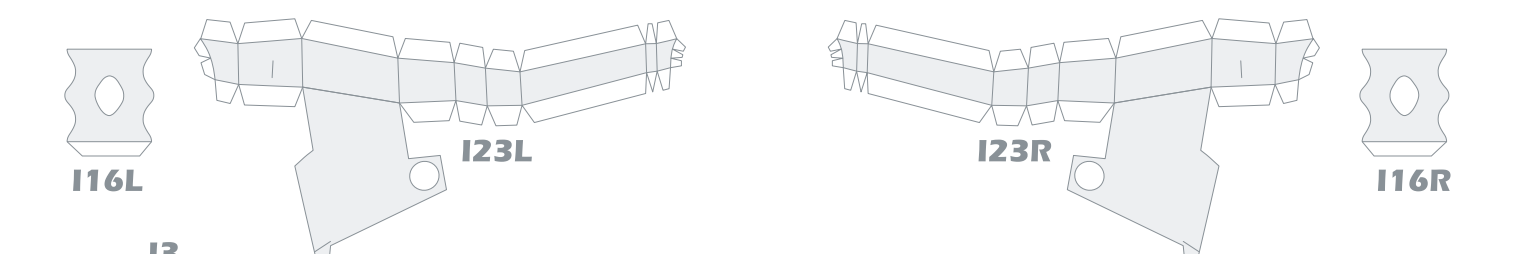
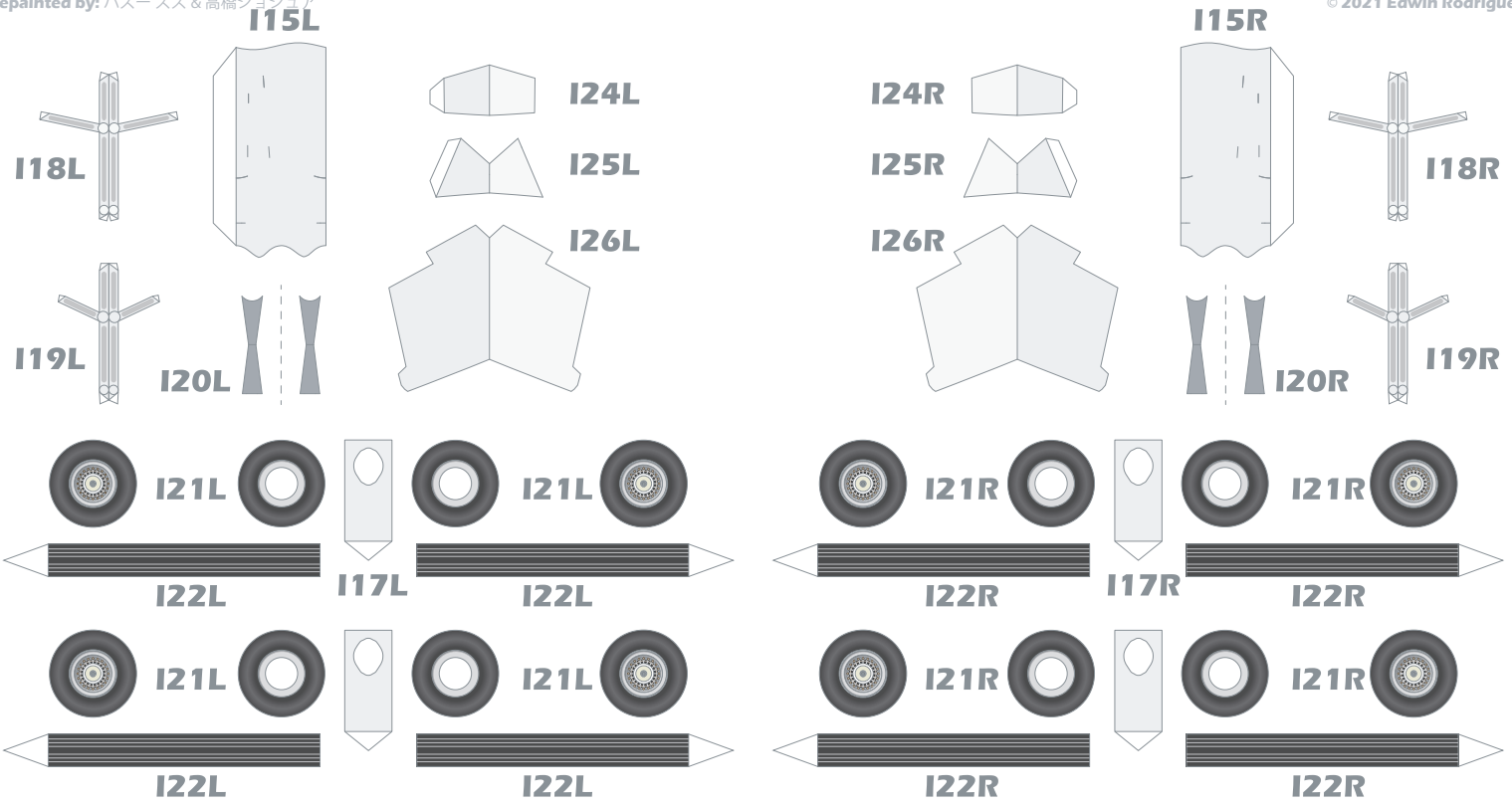

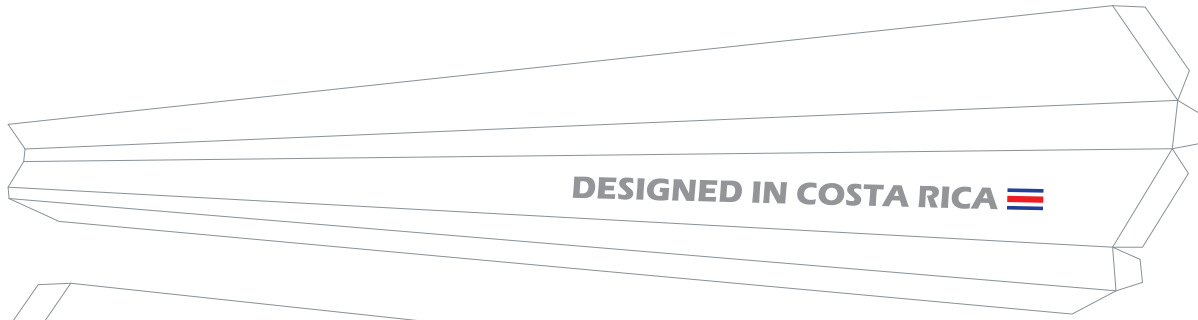

J1L

DESIGNED IN COSTA RICA



J1R

FREE MODEL, DO NOT SELL THE FILE!!!

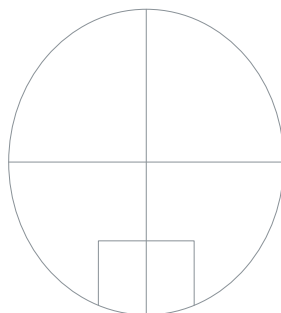
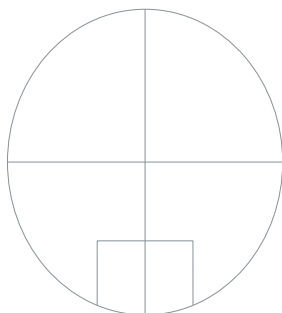
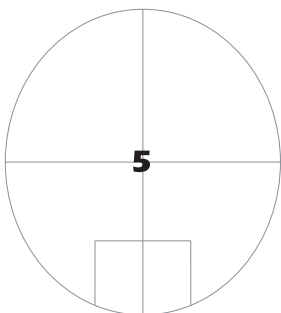
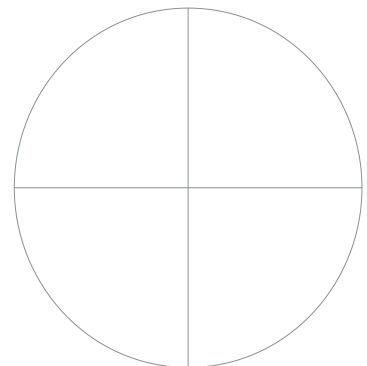
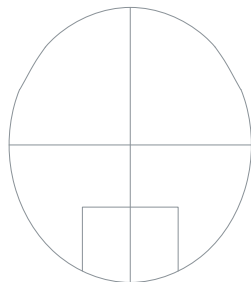
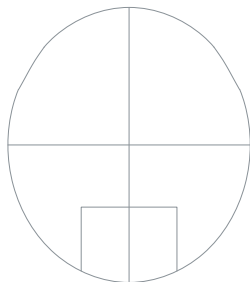
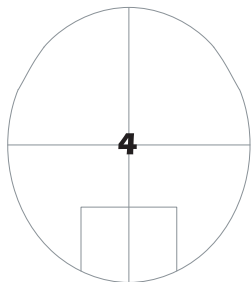
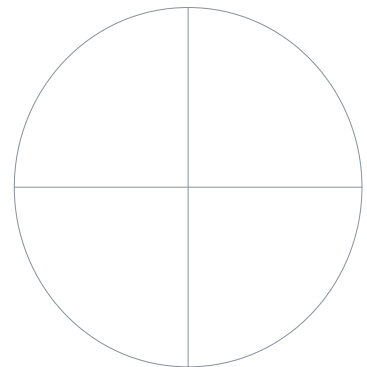
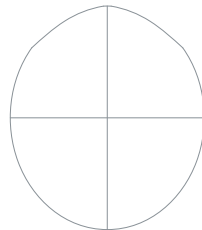
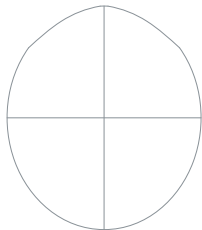
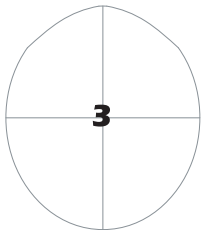
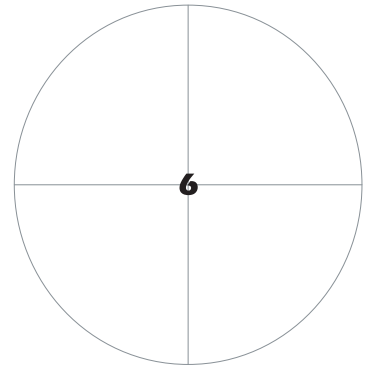
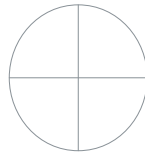
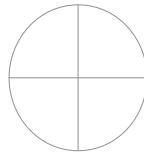
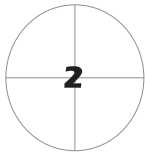

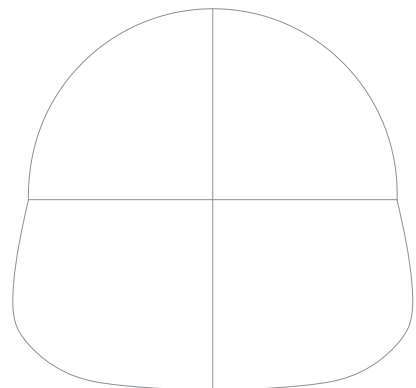
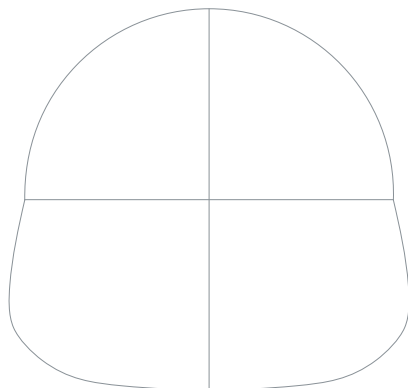
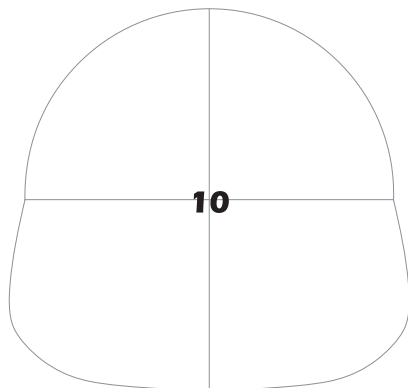
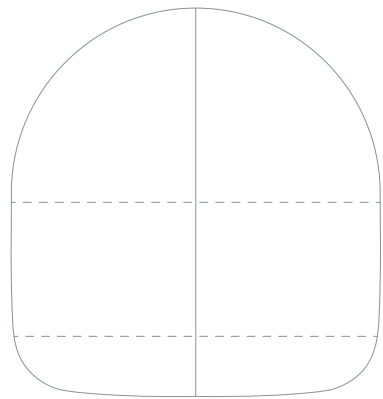
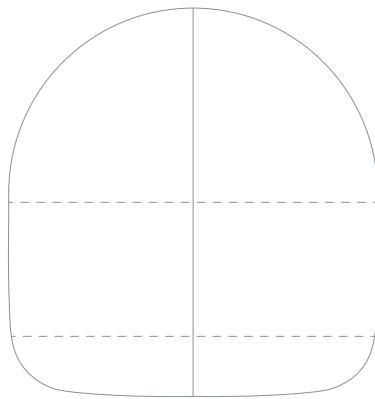
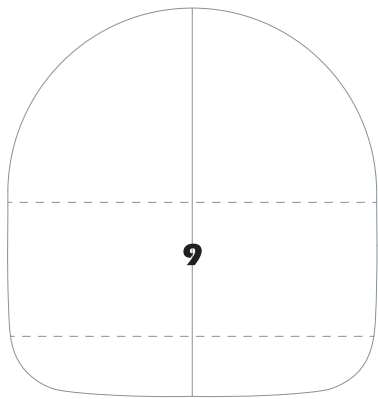
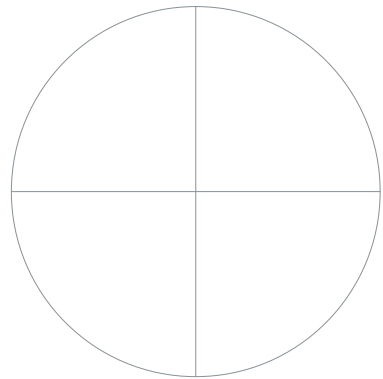
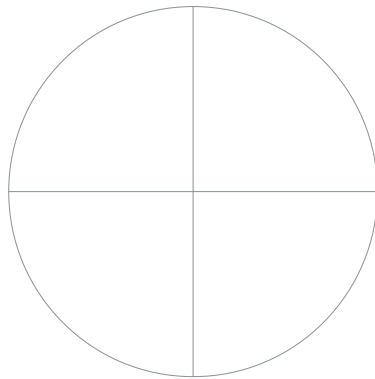
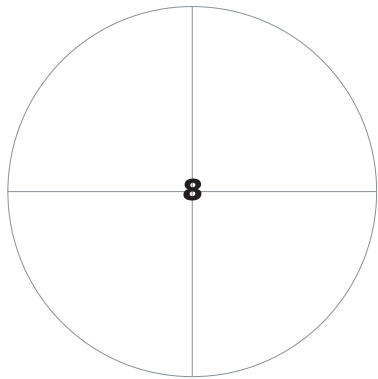
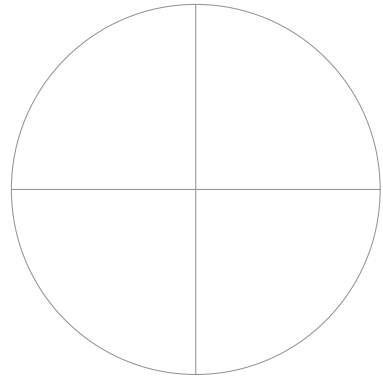
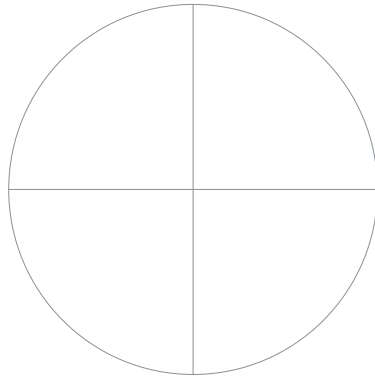
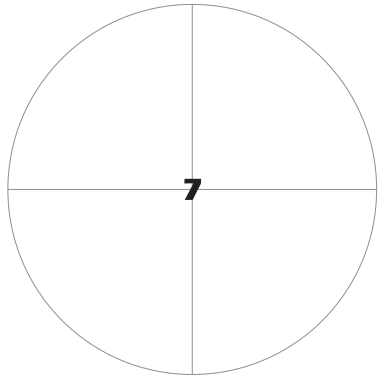

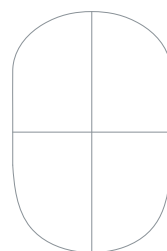
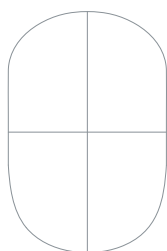
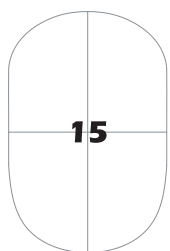
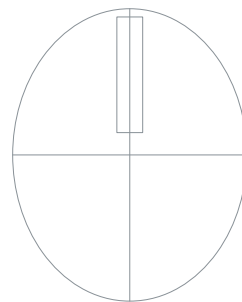
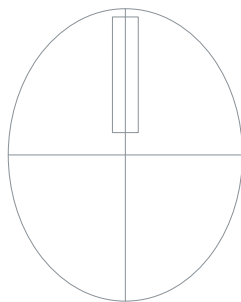
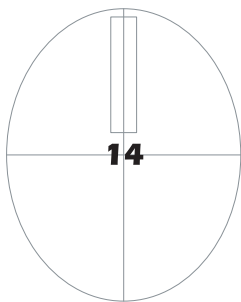
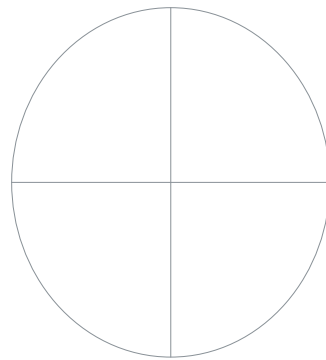
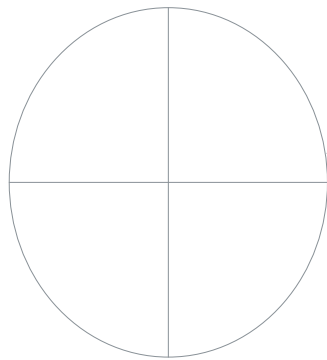
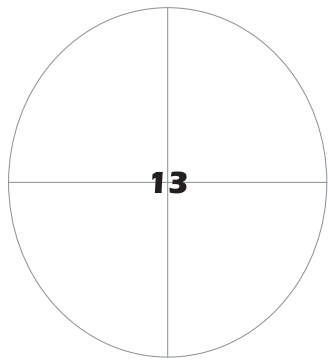
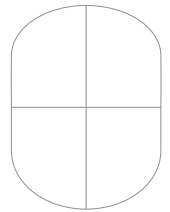
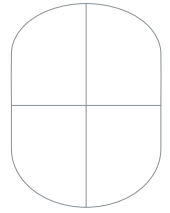
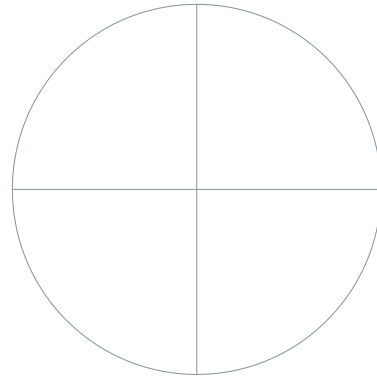
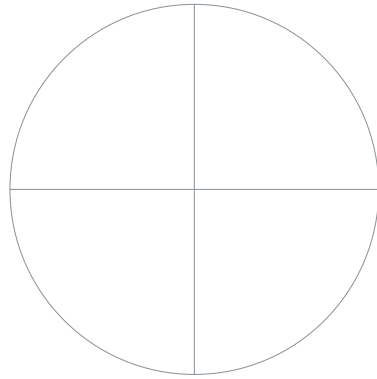
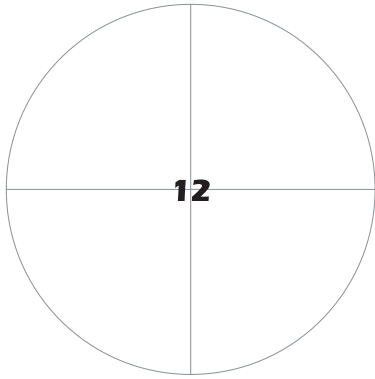
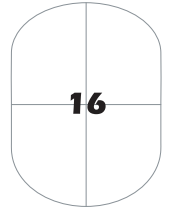
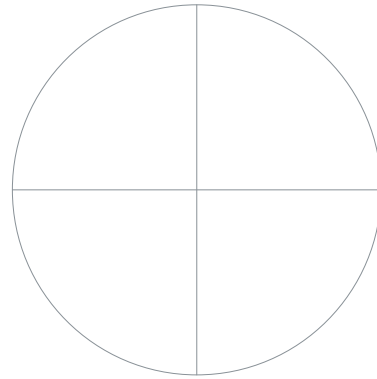
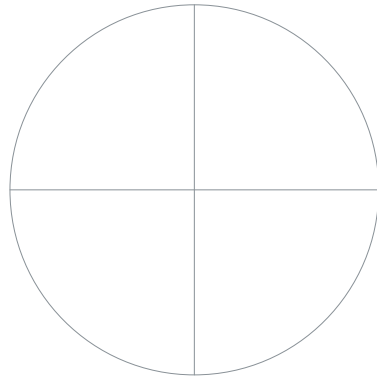
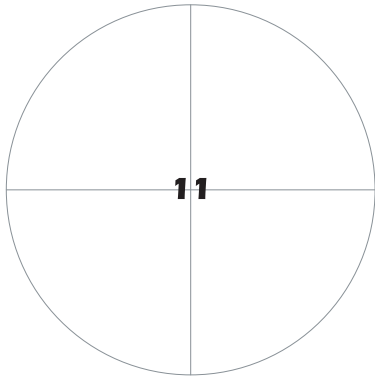



Repainted by: パズー スズ & 高橋ジョシュア

© 2021 Edwin Rodriguez

**ANA
STAR WARS™
PROJECT**

空の旅をもっとエンターテインメントに。

ANAとSTAR WARSのこのプロジェクトは、
あなたの旅をきっと想像以上のものにします。
フォースとともにあらんことを。







ana-sw.com

ORIGINAL MODEL DESIGNED BY EDWIN RODRIGUEZ

HERMERCRAFT

Repainted by: パズー スズ & 高橋ジョシュア

DO NOT SELL THIS FILE | DESIGNED IN COSTA RICA







787



M1

M2

REGISTRATION	
Reg. No.: JA873A	Wingspan: 60.1 m
Length: 62.8 m	Height: 17.0 m
Number of seats: 215	Range with full load: 14,960 km

R2-D2™ ANA JET B787-9

SPECIFICATION

M3

M4

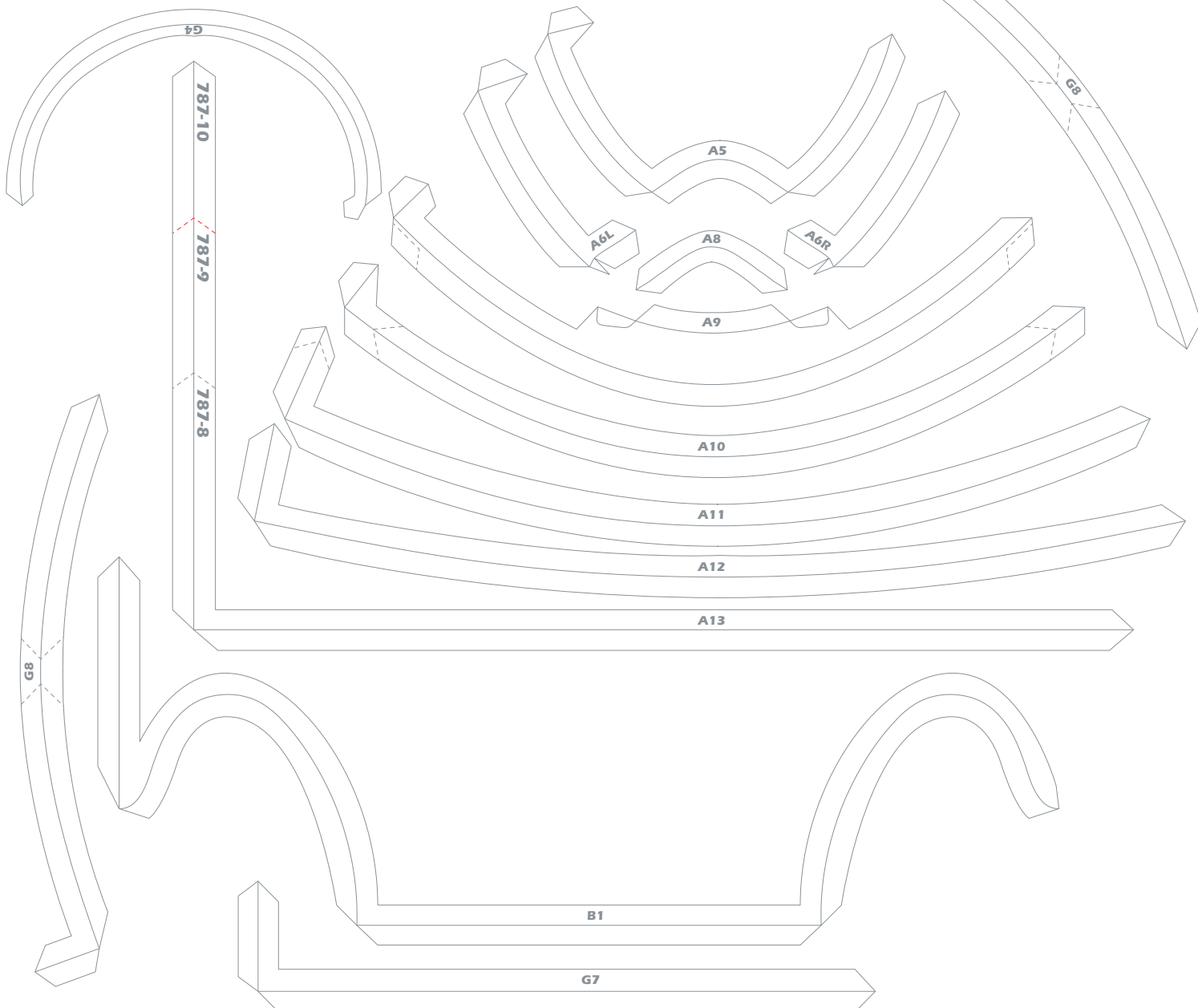
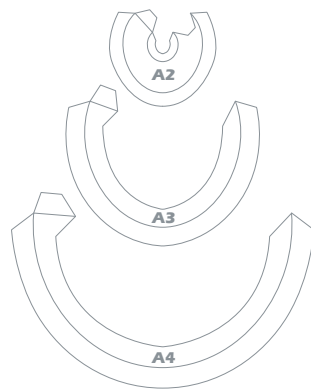
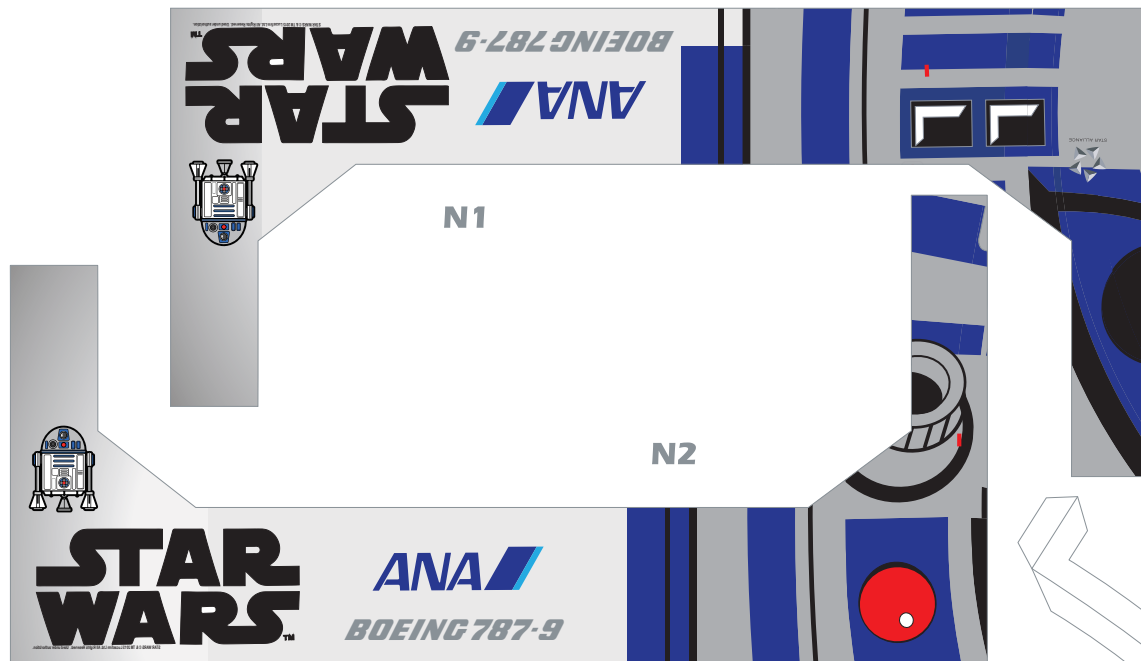



Repainted by: パズーズ&高橋ジョシュア

© 2021 Edwin Rodriguez

